



## Instructions for Use



Tumble Dryer



*Thank you for your trust and for buying our tumble drier. We congratulate you on your wise decision.*

*This appliance is designed for drying clothes for home use only.*

*The dryer enables quick drying of your laundry, leaving it soft and tender without affecting its shape.*

*Our appliances are environmentally friendly: some of the materials are recyclable while others are disposed of and destroyed. To protect the environment, dispose of your appliance by delivering it to the authorized dealer.*

*The appliance is intended exclusively for use in households. If the appliance is used for professional purposes, for profit, or for purposes beyond regular use in a household, or if appliance is used by a person who is not a consumer, the warranty period equals the shortest warranty period possible as stipulated by the relevant legislation.*

|   |           |
|---|-----------|
| <b>Appliance description .....</b>                                | <b>3</b>  |
| <b>Warnings .....</b>   | <b>4</b>  |
| <b>Installation and connection .....</b>                          | <b>5</b>  |
| <b>Operation.....</b>   | <b>8</b>  |
| <b>Tips for drying and for the economic use of the dryer.....</b> | <b>12</b> |
| <b>Cleaning and maintenance .....</b>                             | <b>12</b> |
| <b>Troubles.....</b>  | <b>15</b> |
| <b>Tables .....</b>   | <b>16</b> |

## Appliance description

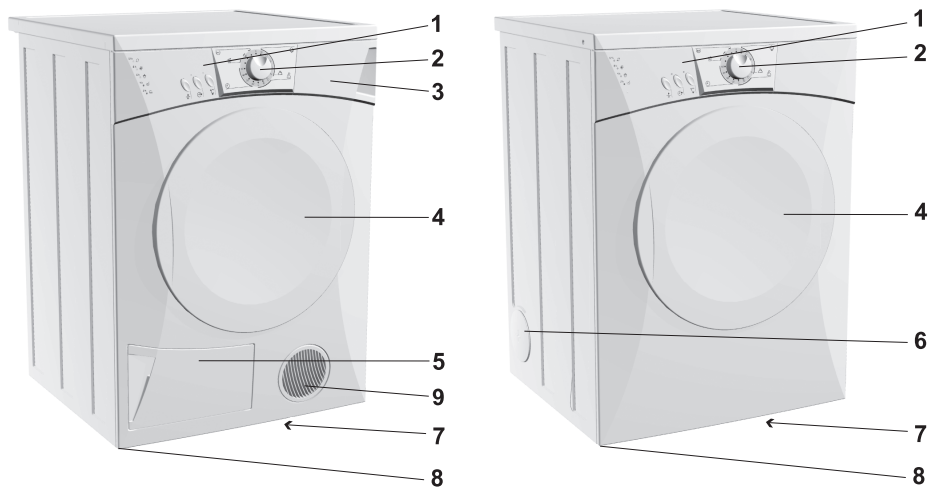

1. Front panel
2. Drying program button
3. Water container
4. Door
5. Condenser

6. Evacuation slots
7. Cooling air slot
8. Legs
9. Front (depending on model)

### Technical data

(depending on model)

#### Dimensions of the appliance (w x d x h):

600 mm x 600 mm x 850 mm

**Weight (net):** evacuation dryer 33 kg,  
condensation dryer 38 kg (depending on model))

**Nominal voltage:** 230 V, 50 Hz

**Connecting power:** 2800 W / 2500 W (depending on model)

**Max. load:** 6 kg / 7 kg

**Connection:** power cord (230 V, 50 Hz, min 16 A)

**Fuse:** 16 A

**Heater:** 2500 W / 2300 W (depending on model)

Name plate with technical information for the appliance is located under the door frame.

237332

# Warnings

- Use the dryer to dry only the laundry washed with water. Do not attempt to dry the laundry, washed or cleaned with flammable detergents or solutions (gasoline, trichloroethylene etc.), as it may cause explosion.
- Do not let the children play with the appliance. Prevent your children or pets to enter the dryer drum.
- When discarding the old appliance remove the power cord and break the lock, so that the door can not be locked (safety precautions for children).
- After cleaning replace the condenser to the air channel. Operating the appliance without the condenser or with a damaged condenser may cause fire.
- Rear wall of the appliance may be hot (for condenser drier only) - danger of burns.
- Clean filter after each drying. If you pulled the filter out, always reinsert it before the next drying operation.
- After use always turn the appliance off (the program selection jog should be in position "0") and unplug the power cord.
- Close the dryer door prior pulling out the water container.
- Leave all repairs to a qualified technician. Tampering with the appliance or repairs by an unqualified person may cause accidents or failures. Call the authorized service department (see list of authorized service departments).
- Name plate with technical information about the appliance is located under the door frame.
- The room must be well aired, surrounding air must not contain dusty particles.
- Room where the appliance is located must be well aired to prevent back flow of gasses, released by open fire gas appliances (fireplace).
- The warranty shall not apply to consumables (bulbs), minor discoloration or deviations of color, increased noise level as a consequence of appliance age, which does not affect appliance functionality, and aesthetical deficiencies which do not affect appliance functionality or safety.
- The appliance is manufactured in compliance with all relevant safety standards; however, it is recommended that persons with impaired physical, motional, or mental abilities, or persons with inadequate experience and knowledge, do not use the appliance without due supervision. The same recommendation applies to minors using the appliance.

## To reduce the fire hazard, always consider the following:

- Do not dry unwashed items in the tumble dryer.
- Items that have been soiled with substances as cooking oil, acetone, alcohol, petrol, kerosene, spot removers, turpentine, waxes and wax removers should be washed in hot water with an extra amount of detergent before being dried in the tumble dryer.
- Items such as foam rubber (latex foam), shower caps, waterproof textiles, rubber backed articles and clothes or pillows fitted with foam rubber pads should not be dried in the tumble dryer.
- Fabric softeners, or similar products, should be used as specified by the fabric softener instructions.
- The final part of a tumble dryer cycle occurs without heat (cool down cycle) to ensure that the items are left at a temperature that ensures that the items will not be damaged.



**Before connecting the appliance read these instructions carefully. Repairing the failure arising from inappropriate connections or use of the appliance is not covered by the guarantee.**

 The belt can be replaced by a servicing engineer only, who incorporates an original spare part with the marking OPTIBELT EPH 1906, code 104265; OPTIBELT 8 EPH 1941, code 160165; HUTCHINSON 8 PHE 1942, code 270313 (depending on model).

 The symbol on the product or on its packaging indicates that this product may not be treated as household waste. Instead it shall be handed over to the applicable collection point for the recycling of electrical and electronic equipment. By ensuring this product is disposed of correctly, you will help prevent potential negative consequences for the environment and human health, which could otherwise be caused by inappropriate waste handling of this product. For more detailed information about recycling of this product, please contact your local city office, your household waste disposal service or the shop where you purchased the product.

 Never stop a tumble dryer before the end of the drying cycle unless all items are quickly removed and spread out so that the heat is dissipated.

## Installation and connection

### **Removing wrapping**

- Packaging materials are environmentally friendly: they can either be recycled, safely disposed of or destroyed, without any threat to the environment.
- To be able to do this effectively all materials are marked accordingly.

 **Be careful not to damage cabinet of the appliance with a sharp object when removing the packaging.**

 **Before connecting the appliance, let it warm up to room temperature (wait for two hours).**

### **Selecting the appropriate location of the appliance**

Ventilation slots and openings on the appliance front and rear wall should not be obstructed.

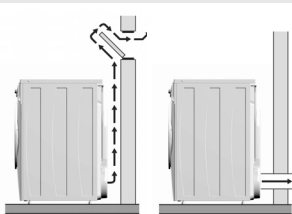

#### **A - Vented dryer**

- Place the appliance in a well ventilated room with a window or a built-in fan.
- Connect the evacuation tube to the pre-prepared opening.
- Evacuation must not be connected to air duct used as a chimney for exhaust gasses of appliances using other combustion material.

#### **B - Condensation dryer**

- Do not place the appliance in a room where there is danger of freezing.
- Location should be adequately ventilated. Room temperature should always be between 0°C and 25°C since frozen water in the condensation water receptacle or in the pump may damage the dryer.

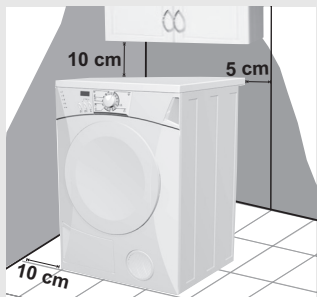

When installing the dryer, please make sure that the appliance is placed in such way that the minimum distances indicated in the figure are complied with. Failure to allow minimum gaps as indicated may cause the appliance to overheat.

## Installation



- Appliance can either stand on its own or can be placed on top of a washing machine of the same dimensions - minimum width 517 mm, depth 476 mm. The surface for placing the dryer must be clean and flat. Use supplied vacuum feet to prevent sliding of the appliance. Washing machine hardtop must be wooden or metallic. To conceal the opening between the two appliances, decorative plate is available on request against payment.

**⚠ Do not place the appliance behind lockable door, sliding door, and door with hinges on the opposite side of the appliance.  
Place the appliance in the room in such way to ensure free opening of the drier door.**



- Level the machine longitudinally and transversally by rotating the adjustable feet, thus enabling the leveling by +/- 1 cm.

**⚠ Vibrations, moving of the appliance and loud operation due to incorrect setting of the adjustable feet shall not be covered by this warranty.**

**⚠ The appliance should be placed on a surface with concrete base; the surface should be dry and clean in order to prevent slipping. The adjustable feet should also be cleaned before installation.**

**⚠ Do not place the dryer on a thick carpet since this could obstruct the air circulation.**

## Moist air outlet

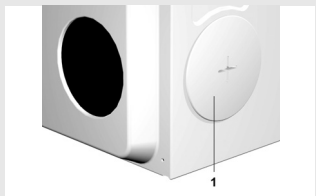

### A - Vented dryer

- There are two openings for venting out humid air. One of them should be closed with the supplied lid, while the other should be connected to the evacuation tube.

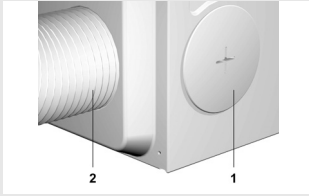

- 1 Lid
- 2 Evacuation tube

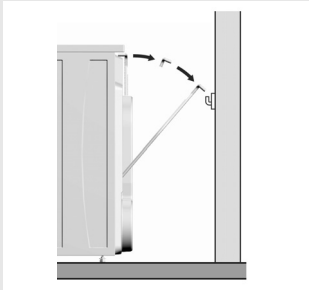
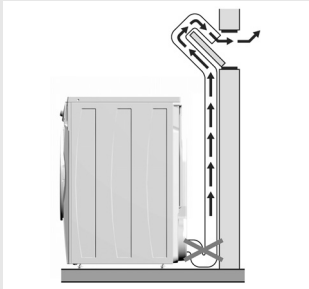

**⚠ The distance between the dryer and the moist air outlet (ventilation shaft, window) should not exceed 2 meters, otherwise water can accumulate in the tube.**

**B - Condensation dryer**

- Moisture from laundry is extracted in the water condensation device and is either collected in the receptacle or discharged directly into the drain (drain height should not exceed 800mm). Appliances fitted with worktop have no possibility of removing the condensed water drain pipe!
- The signal light indicates that the container is full and should be emptied, preferably after each drying cycle.

**Power connection**

- Use the power cord to connect the dryer to the power supply via wall socket.
- Rated voltage and other characteristics are indicated on the name plate, located below the door of the appliance.







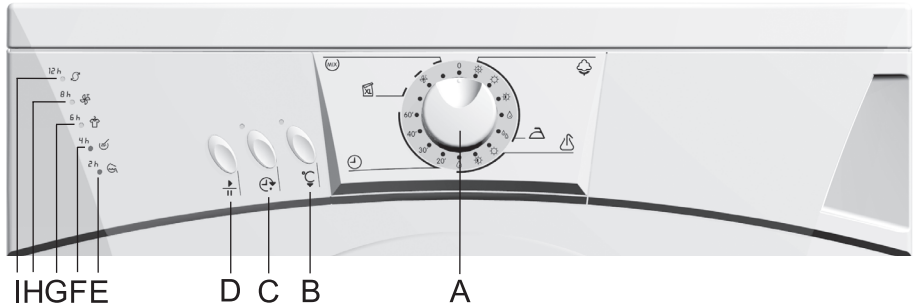





**⚠ The wall socket should always be within reach. It has to be earthed according to the standing regulations.**

**⚠ If the supply cable is damaged it should only be replaced by a qualified technician.**

# Operation



- A - program selection jog**
- B - lower temperature button**
- C - delayed start button**
- D - START / PAUSE button**
- E - water receptacle alarm LED (only condensation dryer)**
- F - filter alarm LED**
- G - drying cycle end / anti crease program button**
- H - cooling LED / ventilation**
- I - drying in progress LED**

| Program selection jog  | Program symbols  | Moisture level  |                 |
|--|--|---|-----------------|
|  |  cotton                     |    | very dry        |
|  |  synthetics                |   | dry             |
|  |  time setting             |  | dry for storage |
|  |  larger pieces of laundry |  | slightly damp   |
|  |  ventilation              |  | iron dry        |
|  |  mixed laundry            |   |                 |



## Drying procedure

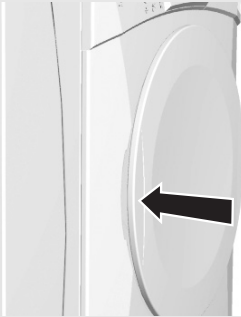

- **Open the dryer door** by pushing the left-hand side of the door towards the appliance.
- **Sort the laundry** according to the type of fabrics.

⚠ **Do the buttons and zippers, tie the strings and pull out the pockets.**

⚠ **Very delicate laundry should be put in a special protective sack.**

⚠ **It is suggested to load the drum with items of different sizes.**

⚠ **Do not load drip-wet laundry into the dryer (min. 800 rpm).**

⚠ **Pay attention to the labels on the clothes, indicating the recommending drying mode (see table of textile treatment symbols on the last page).**

- **Insert the laundry** into the drum (prior making sure that the drum is empty).
- **Close the dryer door.**

## Operating the dryer

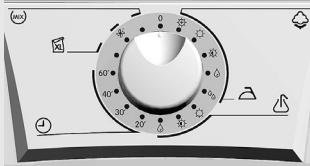

### - Drying program selection

By turning selector jog button (A) select the preferred drying program according to the type of laundry and required final moisture. The selector jog may be turned in both directions.

### - Selection of additional functions

Additional functions are selected prior pressing the START button (D).

#### 🌡 **Decreasing the temperature**

This function is selected if you wish to dry laundry at a temperature lower than determined by the program (see drying programs chart). However this function makes the drying cycle last longer.

⚠ **After drying is completed, this function returns to the initial higher temperature.**

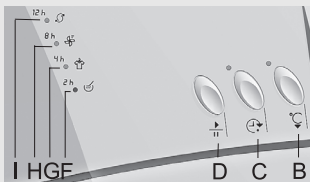

#### 🕒 **Delayed start**

Select this function by pressing the delayed start button (C) (the LED over the button lights up).

The amount of time by which the start of the drying program is delayed increases each time the delayed start button (C) is pressed (from 2h, 4h, etc., up to 12h) (the delay is indicated by the LEDs (E), (F), (G), (H), (I); actual delay may depend on the dryer model. During the delay setting procedure, the LEDs will flash). Then, press the START (D) button. (The LEDs will cease flashing; instead, they will be lit continuously). After the expiration of the set time, the selected program is activated.

Delay can also be set / adjusted while the delay timer is in operation, i.e. during the delay time countdown. To do this, press the  button (C). Confirm the change by pressing the START (D) button.

If the START (D) button is pressed during the delay timer operation (during delay time countdown), the delay will be cancelled and the selected drying program will start immediately.

If there was a power supply failure before the delay time has expired, the START/PAUSE (D) button must be pressed again.



**If the dryer is switched off, this function is reset to its initial position; the delayed start function is deactivated.**

## Drying procedure

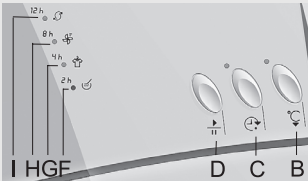
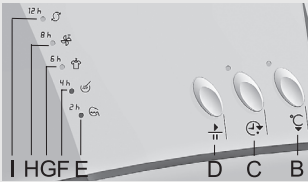

- Drying process is turned on by pressing the **START/PAUSE** button (D); the (I) LED lights.
- If you turn the program selector jog during the drying process, settings do not change, except at the position "0", whereby the program is suspended.
- When the set moisture level is reached, the cooling process starts; the (I) LED goes off and the (H) LED is on.
- If the ventilation program is selected  (see drying programs table) the (H) LED is on throughout the entire program.
- Cooling off period lasts 10 minutes; LED (H) is on.
- Program is suspended if the drum sensor fails to detect laundry in the drum.
- The anti-crease program is active at the end of program and remains active for 1 hour (drum occasionally spins around).
- If you open the drum door after the drying cycle had been completed, the anti-crease program is ended.

### - End of drying procedure



**At the end of the drying procedure the (G) LED flashes, indicating that the drying program has ended. Signal LED's clean the filter (F) and drain the container (E) are on (only for condensation type of dryer).**

- Open the dryer door by pushing the left-hand side of the door towards the appliance.
- Remove the laundry from the dryer.
- Turn the appliance off by turning the jog selector (A) to the position "0".
- Clean the lint filter (see chapter on Cleaning and Maintenance).
- Close the dryer door.
- Empty the water container (this applies for condensation dryers only - see Cleaning and Maintenance) and replace it back to its slot.

## Interruptions



- Pull the power lead from the socket and cut the power supply from the mains.
- **By the user**

**⚠ After drying be careful when extracting laundry from the appliance, as it may be hot!**

### Suspending the operation by pressing the **START/PAUSE** button.

In case you press the **START/PAUSE** button (D) during the drying procedure, the drying program is suspended, and with the next press of the same button the program is resumed where it had been interrupted.

### Changing the program or the functions

If you wish to change the drying program or the additional functions during the drying procedure, move button (A) to the position "0", select new drying program or additional functions and confirm the new selection by pressing the **START/PAUSE** button.

### Door opened

If the door is opened during the drying process this will pause the operation. The (I) or (H) LEDs will flash, depending on the drying process stage. When the door is closed, the drying process resumes only after the **START/PAUSE** button (D) is pressed. The (I) or (H) LED stops flashing.

### • Power failure

If a power failure occurs during the operation of the dryer, ((I) or (H) LED flashes, depending of the drying process stage), press the **START** (D) button to resume the program from where it was interrupted (the LED stops flashing).

### • Water container is full

On a condensation dryer the (E) LED is on, indicating that the water container is full, and the drying program is suspended ((E) and (I) or (E) and (H) LED's are flashing, depending on the drying process stage). When the container is emptied, press the **START** button (D) to reactivate the drying program. The (I) or (H) LED is on again.

## Special functions

### • Drum lamp

The drum is illuminated when the appliance door is open. If the door is open for more than 5 minutes and no changes to the settings have been made, the lamp goes off.

## Tips for drying and for the economic use of the dryer

- Drying is economically most effective if you dry the recommended quantity of laundry per one charge (see Program Chart).
- Do not dry the laundry made of especially sensitive fibers (wool, silk), which may shrink or lose shape.
- It is not necessary to use a fabric conditioner when washing the laundry, since drying makes it soft and tender.
- Drying time is much shorter and consequently the energy consumption lower if laundry is well spun prior tumble dring (minimum 1000 spin RPM).
- By selecting the most suitable drying program, you will avoid over-drying and defficult ironing.
- By cleaning the filter on regular basis drying time is shorter and consumes less energy.
- When drying a smaller quantity of laundry, or individual pieces of clothing, the sensor may not be able to perceive the actual moisture in the fabric. Hence, it is advisable to use either the programs for drying the laundry more thoroughly or time setting programs when drying less laundry or single pieces of it. It is generally recommended to dry larger quantities of laundry, as this will save both time and energy.

## Cleaning and maintenance

### **Cleaning the filter**

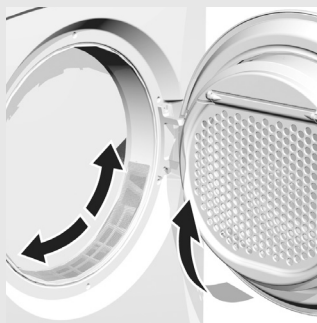

- After every drying clean the filter, located in the inner part of the door.
- Lift the filter lid (Fig.).
- Pull your fingers over the filter to remove fibers and threads lining. Replace the filter cover.
- If necessary, also clean the filter housing and door sealing.

### **Cleaning of the filter on the lower side of the door opening** (only with some models)

Before removing clothes from the drum, clean the filter on the lower side of the door opening with a damp cloth or wet hand.



If the filter is clogged in such way that it needs washing, pull it out from its bed (Fig.), wash it under hot water and dry. Be sure that the replaced filter snaps safely to its position, and only then close the filter lid.

**⚠ If the filter is not regularly cleaned, the airflow is obstructed, which causes longer drying time and danger of overheating.**

## Cleaning the condensation dryer

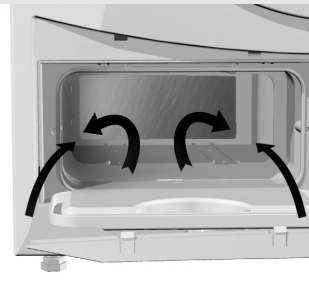
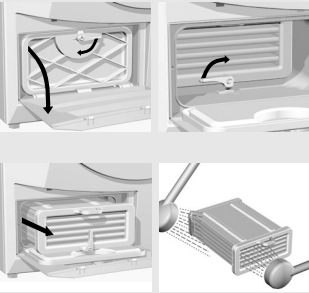
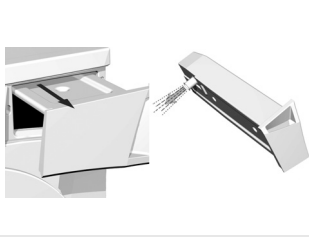

**⚠ Empty the container and occasionally clean the water condensation device.**

### Emptying the water container

Empty the container after every drying procedure: pull the container out, pull out the draining nozzle, pour out the water and replace the container.

**⚠ Water from condenser tank is not drinkable! If filtered it may be used for ironing.**

**⚠ Strictly switch the appliance off prior cleaning (unplug the power cord from the wall socket, or turn the selector jog to the position "0").**

- Clean the casing and drum interior with soft cloth and mild detergent.

### Cleaning the water condensation device

Clean water condenser two to three times a year. In case of frequent use of the appliance do it even more often. Certain amount of water may drip from the condenser when pulled out, so use absorbing cloth for this operation.

- Open the exterior lid of the condenser by grabbing the handle on the lower left part of the appliance housing and pull it downwards.
- Remove interior hatch by rotating the lever vertically down, tilt the hatch towards you and remove it.
- Turn the lock on the condenser upwards and pull the condenser out by pulling the lever.
- Clean the device from both sides with lukewarm water and drain it well.
- Before replacing it into its slot, clean the air channel in which the device is mounted, and the gasket at the interior lid.
- Lock the condenser into its place.
- Insert the inner lid to seal well and lock it with a handle.
- Push the exterior lid towards the appliance to lock to its place.

### After five drying cycles you need to do the following:

- remove, clean/wash and refit the filters on the interior side of the door and the bottom side of door opening;
- remove, clean/wash and refit water condenser;
- wipe the inside of the water condenser compartment with a damp cloth;
- wipe the entire back of the water condenser housing with a damp cloth (reach deeply into the condenser compartment with your hand to touch the back wall of the compartment!);
- wipe all sealings and sealing surfaces of the condenser, condenser housing and condenser door with a damp cloth.

## ***Cleaning of Vented dryer***

### ***Replacing the bulb*** (only with some models)



- Periodically clean (vacuum) the interior of air evacuation opening and evacuation tube.
- Before replacing the bulb disconnect the power cord from the wall socket.
- Open the door.
- Unscrew the cover of the bulb (inside the door opening).
- Replace the bulb. The bulb must be of the same type and power as indicated on the bulb and on the protective cover (max. 10 W).
- Reinsert and tightly screw the cover back. Check if it seals well, otherwise moisture may penetrate the interior and cause short circuit.

# Troubles

Interferences from the ambient (for example electrical wiring) could induce signalization of different faults. In such cases:

- switch the appliance off, and wait for a few seconds;
- plug in the appliance and repeat the drying program.

If the fault repeats, call authorized service shop.

Warranty shall not apply in case of failures due to interferences from the environment (lightning stroke, power supply circuit faults, natural disasters).

| Trouble   | Check  |
|---|--|
| <b>Appliance does not work:</b>                                     | <ul style="list-style-type: none"><li>• If there is current in the socket and if the fuse is functioning.</li><li>• If the plug is correctly inserted into the socket.</li></ul>   |
| <b>There is current in the socket, but the drum is not rolling:</b> | <ul style="list-style-type: none"><li>• If the door is closed tightly (press it towards the appliance).</li><li>• If the program runs according to instructions.</li><li>• If the container is full (only with condensation dryer).</li><li>• If appropriate drying time is selected.</li></ul>  |
| <b>Laundry is not dry:</b>  | <ul style="list-style-type: none"><li>• If the filter is clean.</li><li>• If the condensation device is clean (only with condensation dryer).</li><li>• If the room is adequately ventilated.</li><li>• If the amount of laundry to be dried is not too big.</li><li>• If the evacuation tube is too long (only with vented dryer - max 2 m).</li><li>• If the laundry loaded in the drum has not been spun enough or if appropriate drying time has been set.</li><li>• If the room is too hot (over 25°C, applies for condensation dryer).</li></ul> |
| <b>The condensation is inadequate:</b>                              | <ul style="list-style-type: none"><li>• If the room temperature is too high.</li><li>• If the condensation device is clean.</li></ul>  |
| <b>Unevenly dried laundry:</b>                                      | <ul style="list-style-type: none"><li>• If the amount of laundry to be dried is not too big.</li><li>• If different fabrics are dried together (group the laundry according to the type of fabrics).</li></ul>   |



















The machine signals errors or failures in operation by flashing signal LED's.

Record number of flashes representing the failure, shut the machine off and call nearest authorized service.

If a failure occurs due to incorrect installation or inappropriate use of the appliance, the guarantee is void, and the repair bill shall be settled by the user.

# Tables

## Program chart

| Program  | Type of laundry  | Example of laundry  |
|--|--|---|
| <b>COTTON</b>  <span style="float: right;"><b>max. load: 6 kg / 7 kg</b></span>   |  |   |
| Very dry    | Thick or multiple layer laundry.   | Terry cloth, bathrobe   |
| Dry   | Thick laundry not requiring ironing  | Terry cloth, tricot laundry   |
| Dry for storage   | Uniformly thick laundry, requiring little or no ironing.   | Terry cloth, tricot laundry   |
| Slightly damp   | Fine laundry requiring ironing.  | Tricot, fine cotton undershirts   |
| Iron dry    | Normally thick cotton or flax laundry.   | Table cloths, trousers, shirts, T-shirts, etc.                            |
| <b>SYNTHETICS</b>  <span style="float: right;"><b>max. load: 3 kg / 3,5 kg</b></span>   |  |   |
| Dry   | Thick or multiple layer synthetic or mixed fabrics laundry.  | Pullovers, dresses, blankets  |
| Dry for storage   | Uniformly thick laundry not requiring ironing.   | Shirts, blouses, socks, children's clothes, etc.                          |
| Slightly damp   | Fine laundry, requiring little or no ironing.  | Tricot laundry, undershirts, table cloth, shirts, dresses, sports attires |
| <b>DELICATE (or on reduced temperature at synthetics program)</b>  <span style="float: right;"><b>max. load: 2,5 kg / 3 kg</b></span> |  |   |
| Dry for storage   | Delicate laundry, to be dried at reduced temperature and requires no ironing.  | Blouses, delicate underwear   |
| Slightly damp   | Delicate laundry, to be dried at reduced temperature and requires ironing.   | Blouses, delicate underwear   |
| <b>TIME SET PROGRAM</b>  <span style="float: right;"><b>max. load: 3 kg / 3,5 kg</b></span>   |  |   |
| 20 to 60 minutes   | Single pieces of thick laundry that has to be completely dried, or small amount of laundry (up to 1 kg), ...<br>Basket drying (certain models only).<br>Straightening of laundry - following prior wringing. | Bathrobe, bathing towels, pullovers, ...<br><br>Sports footwear, ...      |
| <b>XL PROGRAM</b>  <span style="float: right;"><b>max. load: 6 kg / 7 kg</b></span>   |  |   |
| Dry   | Larger pieces of laundry; optimal drying – prevents laundry from entangling  | Bedding, table cloths, etc.   |
| <b>AERATION</b> <br>20 minutes  | Laundry to be aired quickly (without heating up).  | Worn clothing   |
| <b>MIXED LAUNDRY (MIX)</b>  <span style="float: right;"><b>max. load: 3 kg / 3,5 kg</b></span>                                      |  |   |
| Dry for storage   | Mixed cotton and combined fabrics laundry.   | Table cloths, clothes, etc.   |



**Program chart/  
additional functions**

| Program                     | Additional functions |               |
|-----------------------------|----------------------|---------------|
|                             | Lower temperature    | Delayed start |
| Cotton                      | ○                    | ○             |
| Synthetics                  | ○                    | ○             |
| Delicate                    | ●                    | ○             |
| Time set program            | ○                    | ○             |
| Larger pieces of laundry XL | ○                    | ○             |
| Ventilation                 |                      | ○             |
| Mixed laundry               | ○                    | ○             |

● compulsory    ○ possible

 **Select the desired program depending on the type of laundry, drum load and drying level.**

**Table of consumption values**







For illustration the chart gives values for 6/7 kg of testing laundry (measured by the EN61121 standard) on different RPM of final spin in washing machine (program dry for storage).

| Rounds/<br>min | Remaining moisture |      | %  | Drying time in minutes |      |                    |          | Power consumption in kWh |      |                    |          |
|----------------|--------------------|------|----|------------------------|------|--------------------|----------|--------------------------|------|--------------------|----------|
|                | L                  |      |    | vented dryer           |      | condensation dryer |          | vented dryer             |      | condensation dryer |          |
|                | 6 kg               | 7 kg |    | 6 kg                   | 7 kg | 6 kg               | 7 kg     | 6 kg                     | 7 kg | 6 kg               | 7 kg     |
| 800            | 4,2                | 4,9  | 70 | 110                    | 130  | 120/110*           | 140/120* | 4,0                      | 4,6  | 4,4/4,1*           | 5,1/5,0* |
| 1000           | 3,4                | 4,0  | 58 | 92                     | 104  | 100/100*           | 117/110* | 3,3                      | 3,8  | 3,7/3,3*           | 4,2/3,9* |
| 1200           | 3,3                | 3,8  | 55 | 85                     | 98   | 95/90*             | 110/100* | 3,1                      | 3,6  | 3,4/3,1*           | 3,9/3,7* |
| 1400           | 3,0                | 3,5  | 50 | 75                     | 89   | 85/80*             | 100/90*  | 2,8                      | 3,2  | 3,1/2,9*           | 3,6/3,4* |
| 1600           | 2,6                | 3,1  | 44 | 68                     | 77   | 74/70*             | 88/80*   | 2,5                      | 2,9  | 2,7/2,6*           | 3,2/3,0* |

\* energy efficiency class B

Measured values may differ from the actual ones due to fluctuations in the type or quantity of laundry, spinning, power oscillation as well as ambience temperature and humidity.

## Table of textile symbols

| Drying  |                                      |
|---|--------------------------------------|
|  | Drying in drier not permitted        |
|  | Drain, hang on washing line and dry  |
|  | Do not drain, hang wet and dry       |
|  | Drain, lay on a flat surface and dry |
|  | Machine drying not permitted         |
|  | Drying at normal temperature         |
|  | Drying at lower temperature          |



