

Panasonic®

Operating Instructions High Definition Mobile Camera

Model No. **HM-TA20**
HM-TA2

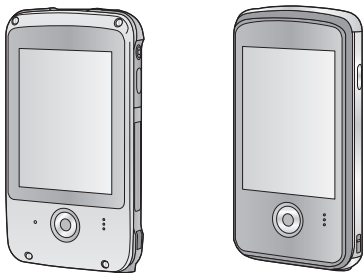

Before use, please read these instructions completely.

HDMI



Model number suffix "EB" denotes UK model.

VQT3P01-1

1AG6P1P6267-A(S)

EB **EP** **GC** **GN**

Information for Your Safety

HM-TA20

WARNING:

TO REDUCE THE RISK OF FIRE, ELECTRIC SHOCK OR PRODUCT DAMAGE,

- Do not let water or other liquids drip or splash inside the unit.
- Do not expose accessories to rain, moisture, dripping or splashing.
- Do not place objects filled with liquids, such as vases, on accessories.
- Use only the recommended accessories.
- Do not remove covers.
- Do not repair this unit by yourself. Refer servicing to qualified service personnel.

HM-TA2

WARNING:

TO REDUCE THE RISK OF FIRE, ELECTRIC SHOCK OR PRODUCT DAMAGE,

- Do not expose this unit to rain, moisture, dripping or splashing.
- Do not place objects filled with liquids, such as vases, on this unit.
- Use only the recommended accessories.
- Do not remove covers.
- Do not repair this unit by yourself. Refer servicing to qualified service personnel.

CAUTION!

- **DO NOT INSTALL OR PLACE THIS UNIT IN A BOOKCASE, BUILT-IN CABINET OR IN ANOTHER CONFINED SPACE. ENSURE THE UNIT IS WELL VENTILATED. TO PREVENT RISK OF ELECTRIC SHOCK OR FIRE HAZARD DUE TO OVERHEATING, ENSURE THAT CURTAINS AND ANY OTHER MATERIALS DO NOT OBSTRUCT THE VENTILATION VENTS.**
- **DO NOT OBSTRUCT THE UNIT'S VENTILATION OPENINGS WITH NEWSPAPERS, TABLECLOTHS, CURTAINS, AND SIMILAR ITEMS.**
- **DO NOT PLACE SOURCES OF NAKED FLAMES, SUCH AS LIGHTED CANDLES, ON THE UNIT.**
- **DISPOSE OF BATTERIES IN AN ENVIRONMENTALLY FRIENDLY MANNER.**

(EB/EP only)

■ EMC Electric and magnetic compatibility

This symbol (CE) is located on the rating plate.

Use only the recommended accessories.

- Do not use any other USB extension cords except the supplied one.
- Keep the Memory Card out of reach of children to prevent swallowing.

Product Identification Marking is located on the bottom of unit.

-If you see this symbol-

■ Information for Users on Collection and Disposal of Old Equipment and used Batteries



These symbols on the products, packaging, and/or accompanying documents mean that used electrical and electronic products and batteries should not be mixed with general household waste.

For proper treatment, recovery and recycling of old products and used batteries, please take them to applicable collection points, in accordance with your national legislation and the Directives 2002/96/EC

and 2006/66/EC.

By disposing of these products and batteries correctly, you will help to save valuable resources and prevent any potential negative effects on human health and the environment which could otherwise arise from inappropriate waste handling.

For more information about collection and recycling of old products and batteries, please contact your local municipality, your waste disposal service or the point of sale where you purchased the items. Penalties may be applicable for incorrect disposal of this waste, in accordance with national legislation.



For business users in the European Union

If you wish to discard electrical and electronic equipment, please contact your dealer or supplier for further information.

[Information on Disposal in other Countries outside the European Union]

These symbols are only valid in the European Union. If you wish to discard these items, please contact your local authorities or dealer and ask for the correct method of disposal.



Cd

Note for the battery symbol (bottom two symbol examples):

This symbol might be used in combination with a chemical symbol. In this case it complies with the requirement set by the Directive for the chemical involved.

■ Indemnity about recorded content

Panasonic does not accept any responsibility for damages directly or indirectly due to any type of problems that result in loss of recording or edited content, and does not guarantee any content if recording or editing does not work properly. Likewise, the above also applies in a case where any type of repair is made to the unit.

■ About recording method and compatibility of this unit

This unit can record detailed high definition images based on the MP4 format (MPEG-4 AVC/H.264 codec).

- Since the recording method is different from the AVCHD format, the data is not compatible.

■ Cards that you can use with this unit

SD Memory Card, SDHC Memory Card and SDXC Memory Card

- 4 GB or more Memory Cards that do not have the SDHC logo or 48 GB or more Memory Cards that do not have the SDXC logo are not based on SD Memory Card Specifications.
- Refer to page 26 for more details on SD cards.

■ For the purposes of these operating instructions

- SD Memory Card, SDHC Memory Card and SDXC Memory Card are referred to as the “SD card”.
- Pages for reference are indicated by an arrow, for example: → 00

These operating instructions are designed for use with models **HM-TA20** and **HM-TA2**. Pictures may be slightly different from the original.

- The illustrations used in these operating instructions show model **HM-TA20**, however, parts of the explanation refer to different models.
- Depending on the model, some functions are not available.
- Features may vary, so please read carefully.
- Not all models may be available depending on the region of purchase.

Contents

HM-TA20

Please be sure to read “(Important) About the Waterproof/Dustproof and Anti-shock Performance of this unit [HM-TA20]” (→ 8) before using this unit underwater to prevent the unit from being mishandled, which may cause water to seep in.

Information for Your Safety.....2 (Important)

About the Waterproof/Dustproof and Anti-shock Performance of this unit [HM-TA20] 8

- Check before using
underwater 10
- Using this unit underwater 12
- Caring of this unit after using it
underwater 13

Accessories..... 16

- Optional accessories 16

Preparation

Parts identification and handling 17

Charging the battery 21

- Charging and motion pictures
recording time 24

- Approximate operating time
and number of recordable
still pictures 24

- Charging and voices recording
time 25

Preparing the card 26

- Cards that you can use with
this unit 26
- Inserting/removing
an SD card 28

Turning the unit on/off 30

How to use the touch screen 31

Setting date and time..... 32

Recording/Playback

Recording 34

- Selecting a mode 34
- Recording motion pictures 35
- Recording still pictures 36
- Recording voices 37
- Intelligent Auto Mode 38
- Digital zoom in/out function 39
- Recording with the LED light... 39
- Night view mode 40
- Effect function
(applying special effects) 40
- For underwater recording
[HM-TA20] 41

Playback 42

- Playing back the slide show/
continuous playback 47
- Zooming in on a still picture
during playback
(Playback zoom) 48
- Deleting scenes, still pictures
or voices 49
- Creating still picture from
motion picture 51
- To delete unwanted parts of
a motion picture 52
- Setting of online sharing of
motion pictures 53

Using the Setup menu screen 54

- Menu list 54

Watching Motion/Still Pictures on your TV 59

With a PC

What you can do with a PC	61
Operating environment	63
Installation	66
Connecting to a PC.....	68
About the PC display.....	70
Starting HD Writer PE 2.0	71
Reading the operating instructions of the software applications	71
If using Mac	72
To use as a camera for Skype	73
How to connect	75

Others

Indications	76
Messages/Troubleshooting.....	79
Cautions for use.....	83
Requests when disposing of this unit.....	88
About copyright	91
Recording modes/ approximate recordable time (motion pictures).....	92
Approximate number of recordable pictures	93
Recording modes/approximate recordable time (voices).....	93
Specifications.....	94
Index	99

(Important) About the Waterproof/Dustproof and Anti-shock Performance of this unit [HM-TA20]

Waterproof/Dustproof Performance

This unit's waterproof/dustproof rating complies with the "IP58" rating. Provided the care and maintenance guidelines described in this document are strictly followed, this unit can operate underwater, to a depth not exceeding 3 m for a time not exceeding 60 minutes. (*1)

Anti-shock Performance

This unit also complies with "MIL-STD 810F Method 516.5-Shock". This unit has cleared a drop test from a height of 1.5 m onto 3 cm thick plywood. In most cases this unit should not sustain any damage if dropped from a height not exceeding 1.5 m. (*2)

This does not guarantee no destruction, no malfunction, or waterproofing in all conditions.

- *1 This means that this unit can be used underwater for specified time in specified pressure in accordance with the handling method established by Panasonic.
- *2 "MIL-STD 810F Method 516.5-Shock" is the test method standard of the U.S. Defense Department, which specifies performing drop tests from a height of 122 cm, at 26 orientations (8 corners, 12 ridges, 6 faces) using 5 sets of devices, and passing the 26 orientation drops within 5 devices. (If failure occurs during the test, a new set is used to pass the drop orientation test within a total of 5 devices.) Panasonic's test method is based on the above "MIL-STD 810F Method 516.5-Shock". However, the drop height was changed from 122 cm to 150 cm dropping onto 3 cm thick plywood. This drop test was passed.
(Disregarding appearance change such as loss of paint or distortion of the part where drop impact is applied.)

■ Handling of this unit

- Waterproofing is not guaranteed if the unit is subject to an impact as a result of being hit or dropped etc. If an impact to this unit occurs, it should be inspected (subject to a fee) by a Panasonic's Service Center to verify that the waterproofing is still effective.
- The waterproof performance may be degraded due to the strong water pressure when this unit is used deeper than 3 m underwater.
- When this unit is splashed with detergent, soap, hot spring, bath additive, sun oil, sun screen, chemical, etc., wipe it off immediately.
- Waterproof function of this unit is for sea water and fresh water only.
- Any malfunction caused by customer misuse, or mishandling will not be covered by the warranty.
- The inside of this unit is not waterproof. Water leakage will cause malfunction.
- Supplied accessories are not waterproof.
- Cards are not waterproof. Do not handle with a wet hand. Also, do not insert wet card into this unit.
- Do not leave this unit for a long period of time in places where temperature is very low (at ski resorts or at high altitude etc.) or very high [above 35 °C], inside a car under strong sunlight, close to a heater, on the beach, etc. Waterproof performance may be degraded.
- **Foreign objects may adhere to the inner side of the door/cover (around the rubber seal or connecting terminals) when the door/cover is opened or closed in places with sand or dust etc. This may result in the impairment of the waterproof performance if the door/cover is closed with foreign objects adhered. Be extremely careful since it may result in malfunction etc.**
- **If any foreign object is adhered to the inner side of the door/cover, remove with the lint-free cloth.**
- **If any liquid such as water droplets is adhered to this unit or inner side of the door/cover, wipe off with a soft dry cloth. Do not open or close the door/cover near the water, when underwater, using wet hands, or when this unit is wet. It may cause water leakage.**

■ When inner side of the lens is fogged (condensation)

It is not a malfunction or failure of this unit. It may be caused by the environment in which this unit is used.

What to do when inner side of the lens is fogged

- Turn off the unit and open the door/cover in a place with constant ambient temperature, away from high temperatures, humidity, sand and dust. The fog will disappear naturally in 10 minutes to 2 hours with the door/cover open when the temperature of this unit gets close to the ambient temperature.
- Contact Panasonic's Service Center if the fogging does not disappear.

Conditions in which inner side of the lens may be fogged

Condensation may occur and the inner side of the lens may be fogged when this unit is used in areas that undergo a significant change in temperature or in high humidity, such as the following:

- **When this unit is used underwater suddenly after being on a hot beach etc.**
- **When this unit is moved to a warm area from a cold area, such as at a ski resort or at high altitude**
- **When the door/cover is opened in a high-humidity environment**

Check before using underwater

Do not open or close the door/cover in places with sand and dust, close to water, or with wet hands. Sand or dust adhering may cause water leaks.

1 Check that there are no foreign objects on the inner side of the door/cover.

- If there is any foreign object, such as lint, hair, sand, etc., on the surrounding area, water will leak within a few seconds causing malfunction.
- Wipe it off with a dry soft cloth if there is any liquid.
It may cause water leaks and malfunction if you use this unit with liquid adhered.
- If there is any foreign material, remove with the lint-free cloth.
- Be extremely careful to remove the small sand etc. that may adhere to the sides and corners of the rubber seal.

2 Check for cracks and deformation of the rubber seal on the door/cover.

- The integrity of the rubber seals may decrease after about 1 year, with use and age. To avoid permanently damaging this unit the seals should be replaced once each year. Please contact Panasonic's Service Center for related costs and other information.

3 Close the door/cover securely.

- Lock the LOCK lever securely until the red part is no longer visible.
- To prevent water seeping into this unit, be careful not to trap foreign objects such as liquids, sand, hair or dust etc.

USB terminal cover

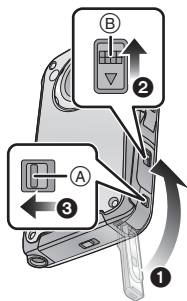

HDMI/Headphone cover

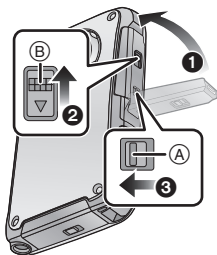

SD card door

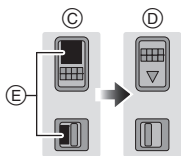
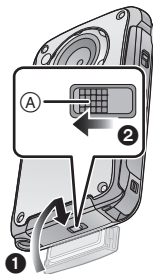

- (A) LOCK lever
- (B) Open/close lever
- (C) Released state
- (D) Locked state
- (E) Red part

Using this unit underwater

- Use this unit underwater at a depth of up to 3 m with the water temperature between 0 °C and 35 °C.
- Do not use this unit at a depth of over 3 m.
- Do not use it in the hot water over 35 °C (in the bath or hot spring).
- Do not use this unit underwater not longer than 60 minutes continuously.
- Do not open or close the door/cover.
- Do not apply shock to this unit underwater. (Waterproof performance may not be maintained, and there is a chance of water leak.)
- Do not dive into the water holding this unit. Do not use this unit in a location where the water will splash strongly, such as rapid flow or waterfall. (Strong water pressure may be applied, and it may cause malfunction.)
- This unit will sink in the water. Take care not to drop this unit and lose it underwater by securely placing the strap around your wrist or similar measure.
- Attaching a tripod with a 5.5 mm screw or larger may open a hole in this unit through which water will leak.
- The touch screen will not work underwater. It will malfunction, so make sure to press the screen lock button. (→ 41)

Caring of this unit after using it underwater

Do not open or close the door/cover until the sand and dust is removed by rinsing this unit with water.

Make sure to clean this unit after using it.

- Thoroughly wipe off any water droplets, sand, and saline matter on your hands, body, hair, etc.
- It is recommended to clean this unit indoors, avoiding places where water spray or sand may fall.

Do not leave this unit uncared for more than 60 minutes after using it underwater.

- Leaving this unit with foreign objects or saline matter on it may cause damage, discolouration, corrosion, unusual odour, or deterioration of the waterproof performance.

1 Rinse with water with the door/cover closed.

- After use at the seaside or underwater, soak the unit in fresh water pooled in a shallow container for 10 minutes or less.

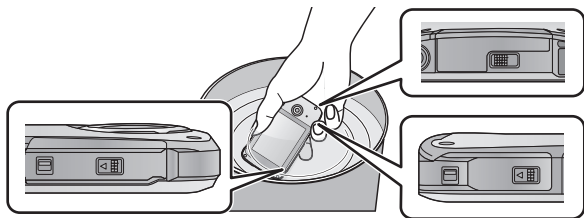

2 Drain water by holding this unit upside down and shaking it lightly a few times.

- After using this unit at the seaside or underwater, or after washing it, water will remain at the speaker site of this unit for a while and it may cause lower sound or sound distortion.
- Fasten the strap firmly to prevent this unit from dropping.

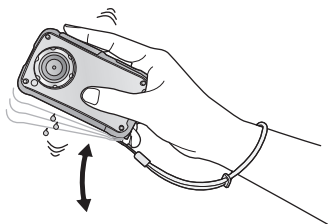

3 Wipe off water drops on this unit with a dry soft cloth and dry this unit in a shaded area which is well ventilated.

- Dry this unit by standing it on a dry cloth.
- Do not dry this unit with hot air from dryer or similar. Waterproof performance will deteriorate due to deformation.
- Do not use chemicals such as benzene, thinner, alcohol, or cleanser, or soap or detergents.



4 Confirm that there are no water droplets, open the door/cover, and wipe off any water droplets or sand left inside using a soft dry cloth.

- Water droplets may adhere to the card when the door/cover is opened without thoroughly drying. Also, water may accumulate in the gap around the card compartment or the terminal connector. Be sure to wipe any water off with a soft dry cloth.
- The water droplets may seep into this unit when the door/cover is closed while it is still wet, causing condensation or failure.

For the United Kingdom and Ireland customers

■ Sales and Support Information

Customer Care Centre

- For customers within the UK: 0844 844 3852
- For customers within Ireland: 01 289 8333
- Visit our website for product information
www.panasonic.co.uk
- E-mail: customer.care@panasonic.co.uk

Technical Support for AV Software

- For customers within the UK: 0844 844 3869
- For customers within Ireland: 01 289 8333

Direct Sales at Panasonic UK

- For customers: 0844 844 3856
- Order accessory and consumable items for your product with ease and confidence by phoning our Customer Care Centre Monday–Thursday 9.00 a.m.–5.30 p.m., Friday 9.30 a.m.– 5.30 p.m. (Excluding public holidays)
- Or go on line through our Internet Accessory ordering application at www.pas-europe.com.
- Most major credit and debit cards accepted.
- All enquiries transactions and distribution facilities are provided directly by Panasonic UK.
- It couldn't be simpler!
- Also available through our Internet is direct shopping for a wide range of finished products, take a browse on our website for further details.

Accessories

Check the accessories before using this unit.
Keep the accessories out of reach of children to prevent swallowing.
Product numbers correct as of April 2011. These may be subject to change.

Hand strap with stylus pen

VFC4708

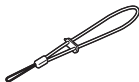

- The stylus pen is used for operations that are hard to operate with your fingers or performing detailed operations with the touch screen operation. (→ 31)

USB extension cord

VFA0545

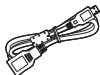

Tripod

VFC4709

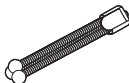

- The unit comes with built-in HD Writer PE 2.0 video editing software.
- Supplied accessories are not waterproof.

Optional accessories

Some optional accessories may not be available in some countries.

HDMI mini cable (RP-CDHM15, RP-CDHM30)

SD/SDHC/SDXC Memory Card (Refer to page 26)

AC adaptor (VSK0746)*

Order number:

(EB) VSK0752*

(EP) VSK0751*

(GC) **A** VSK0752*/**B** VSK0751*

A Hong Kong Special Administrative Region of China and Saudi Arabia

B Areas Other than Hong Kong Special Administrative Region of China, Saudi Arabia

(GN) VSK0753*

* AC adaptor (VSK0746/VSK0751/VSK0752/VSK0753) is only for charging.

Parts identification and handling

HM-TA20

HM-TA2

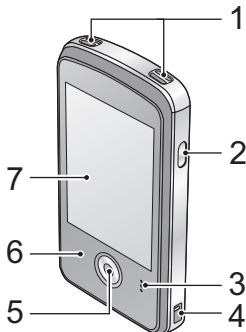
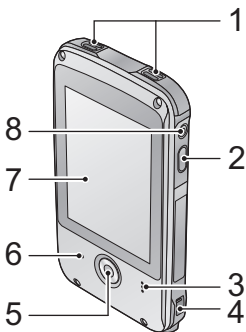

- 1 Internal microphones
- 2 Power button [⏻/⏺] (→ 30)
- 3 Speaker
- 4 Hand strap fixture

• Attach the hand strap to this unit and adjust its length using the stylus pen.

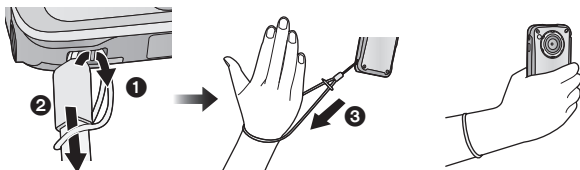

- 5 Recording button (→ 35)
- 6 Status indicator (→ 21, 28, 30, 59)
- 7 LCD monitor (Touch screen) (→ 31)

Due to limitations in LCD production technology, there may be some tiny bright or dark spots on the LCD monitor screen. However, this is not a malfunction and does not affect the recorded picture.

8 HM-TA20

Screen lock button (→ 41)

HM-TA20

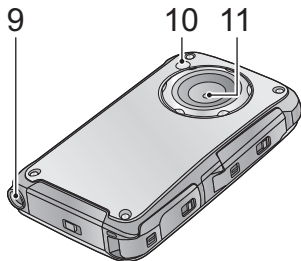

HM-TA2

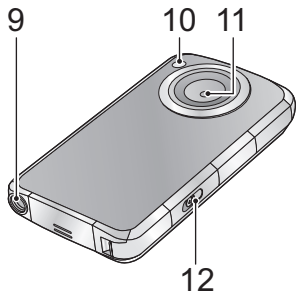

9 Tripod receptacle

- If you attach a tripod which has 5.5 mm screw or larger, it may damage this unit.

10 LED light (→ 39)

11 Lens

12 **HM-TA2**
USB Latch (→ 21)

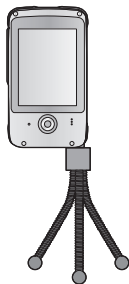

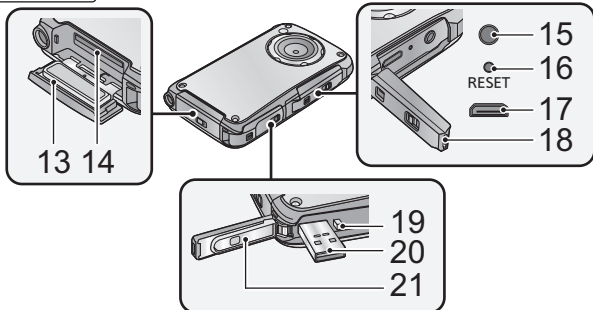
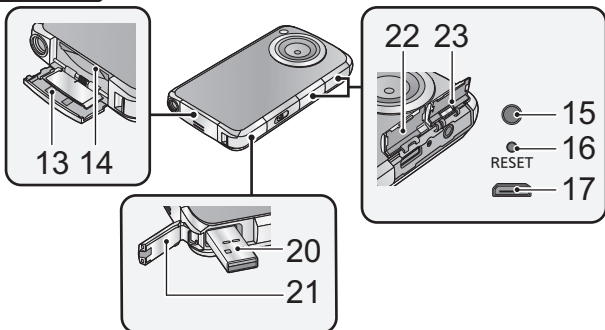
HM-TA20**HM-TA2**

13 SD card door (→ 28)

14 Card slot (→ 28)

15 Headphone terminal [Ω]

- Recommended additional earphones: Panasonic RP-HV154, RP-HJE130 (the product number is correct as of April 2011.)
 - Max. output voltage of unit at earphone terminal: 150 mV or less
 - Wide band characteristic voltage of headphone or earphone: 75 mV or larger
- Excessive sound pressure from earphones and headphones can cause hearing loss.
- Listening at full volume for long periods may damage the user's ears. Be sure to use the supplied or recommended headphones or earphones.

- Use the earphone/headphone with a **A** part width \varnothing 11 mm or smaller.



- 16 **Reset button [RESET] (→ 82)**
- 17 **HDMI mini connector (→ 59)**
- 18 HM-TA20
HDMI/Headphone cover
- 19 HM-TA20
USB Latch (→ 21)
- 20 **USB terminal [] (→ 21, 66, 68, 75)**
- 21 **USB terminal cover (→ 21)**
- 22 HM-TA2
HDMI cover
- 23 HM-TA2
Headphone terminal cover

HM-TA20

About locks for USB terminal cover, HDMI/Headphone cover and SD card door

Each door/cover is equipped with a LOCK lever to lock the open/close lever. When opening and closing the door/cover, slide the LOCK lever and then slide the open/close lever.

USB terminal cover

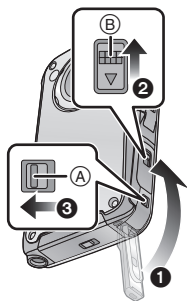

HDMI/Headphone cover

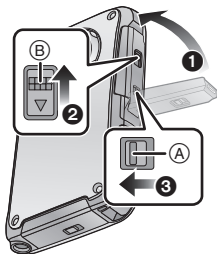

SD card door

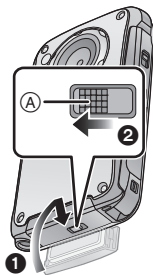

- (A) LOCK lever
- (B) Open/close lever

Charging the battery

When this unit is purchased, the battery is not charged. Charge the battery fully before using this unit for the first time.

Important:

- This unit has a built-in rechargeable lithium-ion battery. Do not remove except when disposing of this unit.
- The battery will not be charged if the unit is turned on.
- The battery can also be charged using the AC adaptor (optional).
(→ 16, 22)

1 Take out the USB terminal.

- Be careful as the USB terminal will jump out.

HM-TA20

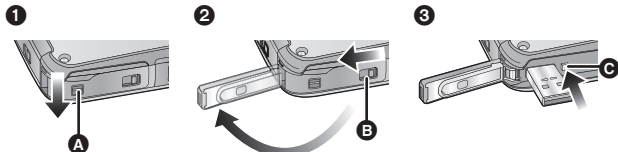

- 1 Slide the LOCK lever for the USB terminal cover **A** to release the lock on the open/close lever for the USB terminal cover **B**.
- 2 Open the USB terminal cover while sliding the open/close lever for the USB terminal cover **B** in the direction indicated by the arrow.
- 3 Press the USB Latch **C** until the USB terminal comes out.

HM-TA2

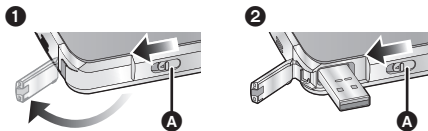

- 1 Slide the USB Latch **A** until the USB terminal cover opens.
- 2 Slide the USB Latch **A** again until the USB terminal comes out.

2 Connect USB terminal of this unit to a PC with a USB extension cord.

- Be sure to connect USB terminal of this unit to a PC with a USB extension cord when charging the battery.
- Connect the USB extension cord by inserting it securely all the way without forcing.

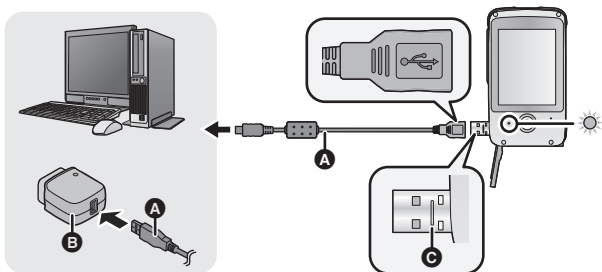

A USB extension cord (supplied)

B AC adaptor (optional)

- Do not use any other USB extension cords except the supplied one. (Operation is not guaranteed with any other USB extension cords.)
- Insert the USB extension cord securely all the way. (Insert to the line **C**.) It will not operate properly if it is not inserted all the way.
- (EB) Always use a genuine Panasonic AC adaptor (VSK0752; optional). (EP) Always use a genuine Panasonic AC adaptor (VSK0751; optional). (GC) Always use a genuine Panasonic AC adaptor (A)VSK0752/(B)VSK0751; optional).

A Hong Kong Special Administrative Region of China and Saudi Arabia

B Areas Other than Hong Kong Special Administrative Region of China, Saudi Arabia

(GN) Always use a genuine Panasonic AC adaptor (VSK0753; optional).

THE SOCKET OUTLET SHALL BE INSTALLED NEAR THE EQUIPMENT AND SHALL BE EASILY ACCESSIBLE.

The unit is in the standby condition when the AC adaptor is connected. The primary circuit is always "live" as long as the AC adaptor is connected to an electrical outlet.

- The status indicator will flash red at an interval of 2 seconds, indicating that charging has begun.
- During charging, the status indicator flashes. When charging is finished, the status indicator turns off.

■ To return the USB terminal to its original position

- When pressing the USB terminal with your fingers, press slowly and carefully.

HM-TA20

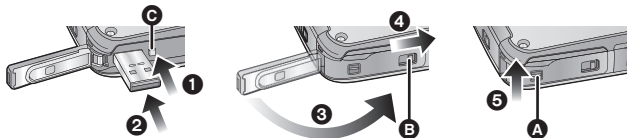

- 1 Press the USB Latch **C**.
- 2 While pressing on the USB Latch **C**, press the USB terminal with your finger.
 - Release your finger from the USB Latch **C**, and push in the USB terminal until it is locked.
- 3 Close the USB terminal cover.
- 4 While the USB terminal cover is closed, slide the open/close lever for the USB terminal cover **B** toward the direction of the arrow.
- 5 Slide the LOCK lever for the USB terminal cover **A** to lock the open/close lever for the USB terminal cover **B**.

HM-TA2

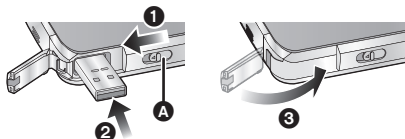

- 1 Slide the USB Latch **A**.
- 2 While the USB Latch **A** is slid, press the USB terminal with your finger.
 - Release your finger from the USB Latch **A**, and push in the USB terminal until it is locked.
- 3 Close the USB terminal cover.

-
- Please refer to page 84 if the status indicator flashes quickly.
 - Do not heat or expose to flame.
 - Do not leave unit in an automobile exposed to direct sunlight for a long period time with doors and windows closed.
 - If the operating time is still too short even after the battery is fully charged, the battery has worn out and needs to be replaced. Consult the dealer who you purchased this unit from.
 - Operation is not guaranteed for all devices equipped with a USB terminal.

Charging and motion pictures recording time

■ Charging/Recording time

- Temperature: 25 °C/humidity: 60%RH

Charging time	Recording mode	Maximum continuous recordable time*	Actual recordable time
4 h 20 min	1080p	1 h 25 min	50 min
	720p / iFrame	1 h 30 min	55 min
	480p	1 h 45 min	1 h

* Maximum continuous recordable time for one scene:

– If [Video Rec Mode] is set to 1080p / 720p / 480p :

29 min 59 sec

– If [Video Rec Mode] is set to iFrame :

Approx. 20 min (up to 4 GB recording capacity)

- These times are approximations.
- **The indicated charging time is for when the battery has been discharged completely. Charging time and recordable time vary depending on the usage conditions such as high/low temperature.**

- The actual recordable time refers to the recordable time when repeatedly starting/stopping recording, turning the unit on/off, adjusting the zoom etc.
- This unit becomes warm after use or charging. This is not a malfunction.

Approximate operating time and number of recordable still pictures

Number of recordable pictures	Approx. 230 pictures	By CIPA standard
Recording time	Approx. 115 min	
Playback time	Approx. 210 min	

Recording conditions by CIPA standard

- CIPA is an abbreviation of Camera & Imaging Products Association.
- Using a Panasonic SD Memory Card (2 GB)

Charging and voices recording time

■ Charging/Recording time

- Temperature: 25 °C/humidity: 60%RH

Charging time	Recording mode	Maximum continuous recordable time*
4 h 20 min	PCM	4 h 30 min
	AAC 256	4 h 30 min
	AAC 128 / AAC 128Low	4 h 30 min

- * Maximum continuous recordable time for one voice:

Approx. 5 h (up to 4 GB recording capacity)

- These times are approximations.
- **The indicated charging time is for when the battery has been discharged completely. Charging time and recordable time vary depending on the usage conditions such as high/low temperature.**

- This unit becomes warm after use or charging. This is not a malfunction.

Battery capacity indication

- The display changes as the battery capacity reduces.



If the battery discharges, then  will become red.

Preparing the card

The following operations can be performed using this unit.

- **When a card has not been inserted: Scenes, still pictures and voices can be recorded on the built-in memory and played back.** ( appears.)
- **When a card has been inserted: Scenes, still pictures and voices can be recorded on the card and played back.**

Normally, insert the card to use.

Cards that you can use with this unit

This unit (an SDXC compatible device) is compatible with SD Memory Cards, SDHC Memory Cards and SDXC Memory Cards. When using an SDHC memory card/SDXC memory card with other equipment, check the equipment is compatible with these memory cards.

Use SD cards conforming to Class 4 or higher of the SD Speed Class Rating* for motion picture recording.

Card type	Capacity	Motion picture/ Voice recording	Still picture recording
SD Memory Card	8 MB/ 16 MB/32 MB/64 MB/ 128 MB/256 MB	Cannot be guaranteed in operation.	Cannot be guaranteed in operation.
	512 MB/1 GB/2 GB	Can be used.	Can be used.
SDHC Memory Card	4 GB/6 GB/8 GB/ 12 GB/16 GB/24 GB/ 32 GB		
SDXC Memory Card	48 GB/64 GB		

* SD Speed Class Rating is the speed standard regarding continuous writing. Check via the label on the card, etc.

e.g.:

CLASS 

-
- Please confirm the latest information about SD Memory Cards/SDHC Memory Cards/SDXC Memory Cards that can be used for motion picture recording on the following website.

http://panasonic.jp/support/global/cs/e_cam

(This website is in English only.)

- 4 GB or more Memory Cards that do not have the SDHC logo or 48 GB or more Memory Cards that do not have the SDXC logo are not based on SD Memory Card Specifications.
- When the write-protect switch **A** on SD card is locked, no recording, deletion or editing will be possible on the card.
- Keep the Memory Card out of reach of children to prevent swallowing.



■ About Built-in Memory

- **Recordable Memory size: Approx. 10 MB**
- **You can not copy the recorded pictures to a card.**
- The built-in memory can be used as a temporary storage device.
- The access time for the built-in memory may be longer than the access time for a card.

Inserting/removing an SD card

When using an SD card not from Panasonic, or one previously used on other equipment, for the first time on this unit, format the SD card. (→ 58) When the SD card is formatted, all of the recorded data is deleted. Once the data is deleted, it cannot be restored.

Caution:

Check that the status indicator has gone off.

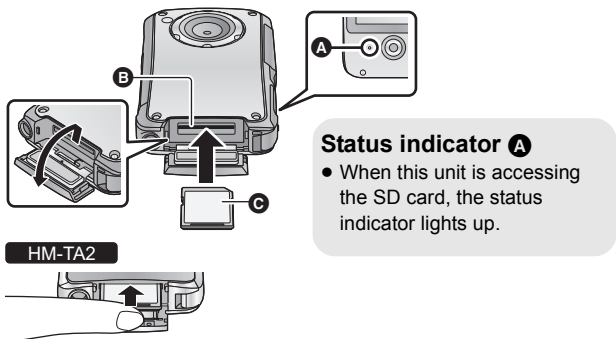

Status indicator **A**

- When this unit is accessing the SD card, the status indicator lights up.

- Insert SD card as shown in the figure.

1 Open the SD card door and insert (remove) the SD card into (from) the card slot **B**.

- Face the label side **C** in the direction shown in the illustration and press it straight in as far as it will go.
- Press the centre of the SD card and then pull it straight out.
- **HM-TA20**

Open the SD card door after releasing the lock with the LOCK lever for the SD card door.

2 Securely close the SD card door.

-
- Do not touch the terminals on the back of the SD card.
 - Do not apply strong shocks, bend, or drop the SD card.
 - Electrical noise, static electricity or the failure of this unit or the SD card may damage or erase the data stored on the SD card.
 - When the status indicator is lit, do not:
 - Remove the SD card
 - Turn the unit off
 - Insert and remove the USB terminal
 - Expose the unit to vibrations or shock

Performing the above while the status indicator is on may result in damage to data/SD card or this unit.

- Do not expose the terminals of the SD card to water, dirt or dust.
- Do not place SD cards in the following areas:
 - In direct sunlight
 - In very dusty or humid areas
 - Near a heater
 - Locations susceptible to significant difference in temperature (condensation can occur.)
 - Where static electricity or electromagnetic waves occur
- To protect SD cards, return them to their cases when you are not using them.
- About disposing of or giving away the SD card. (→ 87)

Turning the unit on/off

Press the power button to turn on the unit.



- The LCD monitor lights on.

To turn off the unit

Continue pressing the power button until the LCD monitor goes off.

■ About the screen display

Please refer to page 76 for details of the icons displayed on the screen.

■ About the power save function

To prevent battery consumption, it will turn off the screen and go into idle mode after approx. 2 minutes of no operation. (The status indicator **A** flashes.)





The unit will be turned off automatically if no operation is performed for a further 5 minutes (approx.) while in idle mode.



- Idle mode is cancelled by pressing the Power button or Recording button.

■ About the high temperature warning icon

When the high temperature warning icon  is displayed, the temperature of the unit is high.

- It is possible to continue recording/playback when  is displayed, but it is recommended to stop operations and turn off the unit as soon as possible.
- If the temperature rises further, the unit will be turned off automatically after  flashes. You will not be able to turn on the unit again until the temperature lowers ( will flash.), so wait until the temperature lowers before using again.
- A countdown until the recording is stopped will start from approx. 15 seconds during motion picture recording, and the recording will stop when the display reaches 0 seconds.
- When you turn off the unit while the temperature is high ( is displayed.), you will not be able to turn on the unit again until the temperature lowers. ( will flash.)

How to use the touch screen

You can operate by directly touching the LCD monitor (touch screen) with your finger.

It is easier to use the stylus pen (supplied) for detailed operation or if it is hard to operate with your fingers.

■ Touch

Touch and release the touch screen to select icon or picture.

- Touch the centre of the icon.
- Touching the touch screen will not operate while you are touching another part of the touch screen.



■ Slide while touching

Move your finger while pressing on the touch screen.

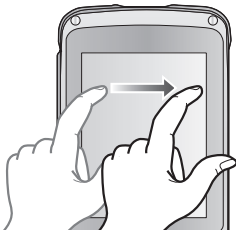



-
- Do not touch on the LCD monitor with hard pointed tips, such as ball point pens.

Setting date and time

1 Select the menu. (→ 54)

 [MENU] →  → [CLOCK SET]

2 Touch the date or time to be set, then set the desired value using  / .

- The year can be set between 2000 and 2039.
- The 24-hour system is used to display the time.

3 Touch [ENTER].

-
- **The clock is not set when the unit is shipped.**
 - When the unit is turned on for the first time, a message asking you to set the date and time will appear.
 - The date and time function is driven by a built-in lithium battery.
 - If the built-in lithium battery needs to be charged, the message "Set date and time" appears. To recharge the built-in lithium battery, connect USB terminal of this unit to a booted PC. Leave the unit as it is for approx. 24 hours and the battery will maintain the date and time for approx. 3 months. (The battery is still being recharged even if the unit is off.)
 - The date and time will be set to January 1, 2011 00:00 when recording is performed without the date and time set.

(EB Only)

WARNING

THE LITHIUM BATTERY IN THIS EQUIPMENT MUST ONLY BE REPLACED BY QUALIFIED PERSONNEL. WHEN NECESSARY, CONTACT YOUR LOCAL PANASONIC SUPPLIER.

(For Australia and New Zealand)

WARNING

THE LITHIUM BATTERY IN THIS UNIT MUST ONLY BE REPLACED BY QUALIFIED PERSONNEL. IF THIS IS NECESSARY, CONTACT THE PANASONIC CUSTOMER CARE CENTRE ON 132600 FOR YOUR NEAREST AUTHORIZED SERVICE CENTRE.

Recording







- This unit will perform automatic recording. Auto focusing, auto white balancing, and electronic stabilizer* will function during the recording.
 - * The electronic stabilizer will not function when recording still pictures or during operation of digital zoom.
- Record with this unit vertically.

Selecting a mode

1 Touch [MODE].

- If [MODE] is not displayed, press the Recording button.

2 Touch the icon.

	Motion Picture Recording Mode (→ 35) <ul style="list-style-type: none"> •  appears on the screen.
	Still Picture Recording Mode (→ 36) <ul style="list-style-type: none"> •  (White) appears on the screen.
	Voice Recording Mode (→ 37) <ul style="list-style-type: none"> •  (White) appears on the screen.

Recording motion pictures

When in Motion Picture Recording Mode

1 Press the Recording button to start recording.

- When you begin recording, **II** changes to **●**.



2 Press the Recording button again to pause recording.

- The images recorded between pressing the Recording button to start recording and pressing it again to pause recording become one scene.
- In the following cases, the countdown until the recording is stopped will start from approx. 30 seconds and the recording will stop when the display reaches 0 second.
 - When the total of the capacity of the SD card is about to be used during the recording.
 - When the recording time reaches near the maximum continuous recordable time for a single scene. (→ 92)
- Please refer to page 92 for details on continuous recordable time for a single scene.
- Maximum number of recordable scenes on a single SD card is 899100.
- Operation sound may be recorded when you perform touch operation while recording.

■ About the screen display when recording motion pictures

1080p : Recording mode

● : Recording motion picture

II : Recording pause

01h30m : Remaining time for motion picture recording

00m00s : Elapsed recording time

- “h” is an abbreviation for hour, “m” for minute and “s” for second.

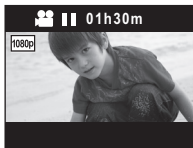

About the compatibility of the recorded motion pictures



- They are not compatible with devices other than those that support MP4. Images cannot be played with equipment that does not support MP4. Confirm that your equipment supports MP4 by referring to the operating instructions.
- There are some cases where the recorded motion pictures cannot be played back, even if the device supports MP4. In such cases, play the recorded motion picture with this unit instead.

Recording still pictures

When in Still Picture Recording Mode



Press the Recording button.



-  is displayed where the focus is set.
-  (Red) appears on the screen.

- **Still pictures cannot be recorded while recording the motion picture.**
- The screen aspect ratio changes depending on the number of recording pixels that is set.
- The focus prioritises closer subjects. If  is not displayed at the desired position, reset the focus by getting closer to the subject or moving the unit, etc.
- Using a tripod is recommended when recording still pictures in dark places because the shutter speed becomes slow.
- The screen will turn black for an instant when pressing the Recording button.

■ About the screen display when recording still pictures

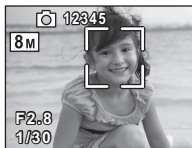

-  : Still picture operation indicator
-  : Number of recording pixels for still pictures
- **12345**: Remaining number of recordable pictures
-  : Focus area
- **F2.8**: Iris value
- **1/30**: Shutter speed



Recording voices

When in Voice Recording Mode

1 Press the Recording button to start recording.

- When you begin recording,  (White) changes to  (Red).



2 Press the Recording button again to pause recording.

■ To record still pictures while recording voices

1 Touch .

- An image is displayed on the screen, and you will be able to record still pictures.

2 Touch to record a still picture.

-
- To prevent battery consumption, it will turn off the screen after approx. 2 minutes of no operation during voice recording. To display it again, touch the screen.
 - Operation sound may be recorded when you perform touch operation while recording.

■ About the screen display when recording voices

 : Recording mode

 : Recording voice

01h30m : Remaining time for voice recording









01h30m59s: Elapsed recording time

- “h” is an abbreviation for hour, “m” for minute and “s” for second.



Intelligent Auto Mode

The following modes (appropriate for the condition) are set just by pointing the unit to what you want to record.

Mode		Scene
	Portrait	When the object is a person
	Scenery	Recording outdoors
 *1	Spotlight	Under a spotlight
 *2	Night portrait	Recording night portrait
 *2	Night scenery	Recording night scenery
 *2	Macro	Recording zooming in on a flower etc.
 *1  *2	Normal	Other situations

*1 In Motion Picture Recording Mode only

*2 In Still Picture Recording Mode only

- Depending on the recording conditions, the unit may not enter the desired mode.
- In the Portrait, Spotlight mode, the face will be surrounded by white frame when detected. In the Portrait mode, a subject that is bigger and close to centre of the screen will be surrounded by an orange frame.
- Up to 3 frames are indicated when a face is detected.
- When recording still pictures during voice recording, the Intelligent Auto Mode icon does not display on the screen. But the Intelligent Auto Mode will work.
- Using a tripod is recommended in Night Portrait and Night Scenery Mode.
- Faces cannot be detected depending on the recording conditions, such as when faces are of certain sizes or at certain tilts.

Digital zoom in/out function

The maximum digital zoom ratio is $\times 4$.

Touch and hold  or .

- You can also zoom by directly touching the zoom bar.



-
- Motion picture: Independent of zoom magnification, this unit can focus on a subject approx. 30 cm away from the lens.
Still picture: Independent of zoom magnification, this unit can focus on a subject approx. 10 cm away from the lens.
 - The larger the zoom magnification, the more the image quality is degraded.

Recording with the LED light



The LED light enables brightening of the images taken in a dimly-lit place.

1 (While the recording is paused)

Touch  [MENU].

2 **Touch** .

Each time  is touched, the LED light is turned on or off.

-
- The setting will be cancelled when you turn off the unit or touch  [PLAY].
 - When the LED light is in use, the recordable time when using the battery is shortened.
 - The subject should be within approx. 80 cm of the unit.
 - Turn off the LED light at places where using a light is prohibited.
 - Do not look directly at the LED light when it is on.
 - The bright light may hurt your eyes.
 - Keep a distance of at least 1 m when recording babies.
 - Do not use pointing the LED light at drivers etc. as it may lead to accidents.
 - 

Setting for the LED light will be maintained even when the unit is turned off during the screen lock mode.

Night view mode

It is possible to record brighter than usual.

◇ **Change the mode to Motion Picture Recording Mode.**

1 Touch  [MENU] while the recording is paused.

2 Touch .

• Each time  is touched, the night view mode is turned on or off.

When the scene is dark, or when the night view mode is on and the scene becomes bright,

 will flash automatically.

You can also turn the night view mode on/off by touching .



- You cannot turn the night view mode on/off while recording.
- When the night view mode is on, Intelligent Auto Mode does not work.

Effect function (applying special effects)





You can record with effects such as changing the colour tone or making the skin tone smooth.

1 Touch  [MENU] while the recording is paused.

2 Touch .

3 Touch the desired effect icon to be set.

- Selected effect icon will be displayed in yellow, and the effect will be reflected on the screen.

	Cancels the setting.
	Makes it black and white.
	Makes it sepia tone.
	Makes the skin tone smooth.

- The setting will be normal when you turn off the unit or touch  [PLAY].

For underwater recording [HM-TA20]

This unit can record motion pictures/still pictures under water to a depth 3 m.

1 Press and hold the screen lock button until the message appears.

- You cannot perform touch operations.
- While setting  [MENU] or [MODE], it cannot be set to the screen lock mode.
- To release the screen lock mode, press and hold the screen lock button again.

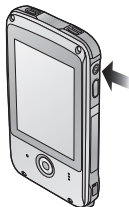

2 Press the Recording button.



- To switch between Motion Picture Recording Mode and Still Picture Recording Mode



Press the screen lock button.

-
- When you use the screen lock mode, you have the following limitations.
 - The effect function will be released.
 - The zoom magnification will be $\times 1$.
 - To use the LED light, turn on the LED light setting, and then set to screen lock mode. (→ 39)

Playback

During playback, we recommend you use this unit horizontally. In these operating instructions, instructions for playback are given primarily for using horizontally.

1 Touch [PLAY].

- The last recorded scene or still picture or voice will be played back.
- If voices to be played back was recorded with still pictures, the still picture is displayed. Touch  /  on the still picture or slide the screen display from right to left (from left to right) while touching it to playback next (previous) still picture.
- Playback will end and it will go into pause mode for recording when the Recording button is pressed.

2 Hold this unit horizontally.

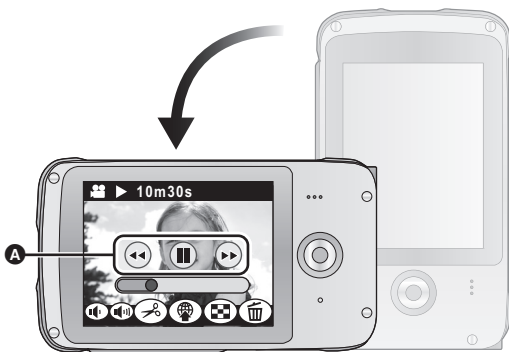























A Operation icon

- The screen display automatically switches to horizontal.
- To display the operation icon, touch the screen. It will disappear when there is no operation for a few seconds.

3 Select the playback operation by touching the operation icon.

■ Playback operation

Icon/ Playback operation	Operating steps	Playback data
 Thumbnail display	(Only playing back horizontally) Touch  during pause. (→ 44)	All
 Pause	Touch  during playback.	Scenes/ Voices
 Volume adjustment	Touch  or  during playback.  :Increases the volume  :Decreases the volume	All
 Fast forward/rewind playback	Touch  (fast forward playback) or  (rewind playback) during playback or pause.	Scenes/ Voices
 Playback	Touch  during pause. • Playing back the slide show/ continuous playback (→ 47)	All
 Skip playback (to the start of a scene/voice) To the next (previous) still pictures	Touch  or  during playback or pause.	All
 Direct playback	Touch the Direct playback bar or slide it while touching. • The playback pauses temporarily and skips to the position touched or slid to while touching. • Playback will start by releasing your touching or sliding finger.	Scenes/ Voices

- It is possible that you touch  (Frame-by-frame playback) or  (Reverse frame-by-frame playback) when editing. (→ 51, 52)
- To playback next (previous) scene, still picture or voice:
 - Touch  / .
 - Slide the screen display from right to left (from left to right) while touching it.



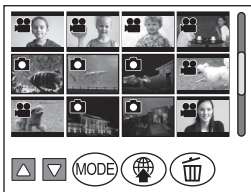

- When selecting a scene, still picture or voice to be played back from thumbnail display

Scene/Still picture

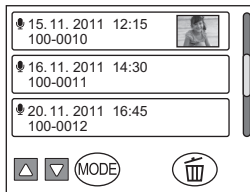

Voice



- 1 Touch  .
- 2 Touch scene, still picture or voice to be played back.
 -  is displayed for scene, and  is displayed for still picture.
 - To display the next (previous) page:
 - Touch  /  .
 - Slide the thumbnail display upward (downward) while touching it.

■ When switching the thumbnail display for scene/still pictures and voice

Touch [MODE].

■ Playback with this unit vertically

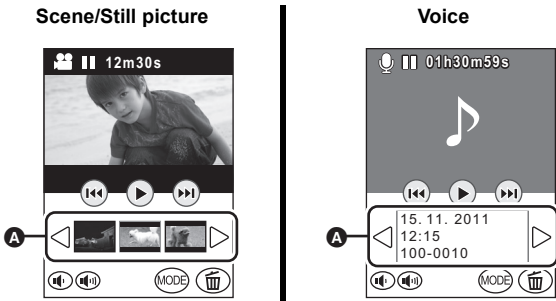

Touch the thumbnail display **A**, then the touched scene, still picture or voice will play back. Touch \triangleright / \triangleleft , the next (previous) page can be displayed.

- The only time you can display the thumbnail is while paused.
- $\left(\frac{\text{scissors}}{\text{camera}}\right)$ (\rightarrow 52), $\left(\frac{\text{camera}}{\text{camera}}\right)$ (\rightarrow 51), $\left(\frac{\text{globe}}{\text{globe}}\right)$ (\rightarrow 53) and $\left(\frac{\text{checkered}}{\text{checkered}}\right)$ (\rightarrow 44) icons will be displayed only when playing back horizontally.

■ About the screen display during playback

00m00s: Playback time (Motion Picture Playback Mode only)

- 00h00m00s is displayed during the Voice Playback Mode.

100-0001: File number

15. 11. 2011: Date indication



Motion picture compatibility

- This unit is based on the MPEG-4 AVC file format.
- This unit may degrade or not play back motion pictures recorded or created on other products, and other products may degrade or not play back motion pictures recorded on this unit, even if the products support MP4.

Still picture compatibility

- This unit is compliant with the unified standard DCF (Design rule for Camera File system) established by JEITA (Japan Electronics and Information Technology Industries Association) and with Exif (Exchangeable Image File Format). Files which do not comply with the DCF standard cannot be played back.

Voice compatibility

- This unit is compliant with LPCM file standards and AAC file standards.
- This unit may degrade or not play back voices recorded or created on other products, and other products may degrade or not play back voices recorded on this unit.

Playing back the slide show/continuous playback

Recorded motion pictures/still pictures or voices can be played back as a slide show/continuous playback.

For motion pictures/voices

Touch and hold ► for approx. 2 seconds.

For still pictures

Touch ►.

-  appears.
- Slide show/continuous playback will start from the scene/still picture or voices that is currently being played back. It will stop once all the recorded scenes/still pictures or voices are played back.
- Scenes are played back normally, and still pictures are played back for approx. 2 seconds each.



To cancel playing back the slide show/continuous playback



Touch **||**.

- The unit will switch to the normal playback screen for the scene/still picture or voices that was being played back when the slide show/continuous playback was cancelled. (Scenes or voices will go into pause mode.)
-
- For the still pictures recorded while voice was recorded and played back during the continuous playback of the voice, it is possible to display the next (previous) still picture by sliding the screen display from right to left (from left to right) while touching it. (Still pictures will not change automatically by the voice that is being played back.)

Zooming in on a still picture during playback (Playback zoom)

You can zoom in by touching a still picture during playback.

1 Touch , and then touch the screen display during still picture playback.

- The still picture is zoomed in order of normal display ($\times 1$) $\rightarrow \times 2 \rightarrow \times 4$. Touch  to zoom in from normal display to $\times 2$, touch the screen display to zoom in from $\times 2$ to $\times 4$.
- The still picture is zoomed in on, centring on the part you touched.
- You can also zoom by touching .

2 Move to the zoomed in position by sliding the screen display while touching it.

Zooming out from the zoomed still picture

Touch  to zoom out. ($\times 4 \rightarrow \times 2 \rightarrow \times 1$)

- Touch [1 \times] to return to normal playback ($\times 1$).

Deleting scenes, still pictures or voices

Deleted scenes, still pictures or voices cannot be restored, so perform appropriate confirmation of the contents before proceeding with deletion.

- When a card has been inserted, scenes, still pictures and voices can be deleted on the card.
- When a card has not been inserted, scenes, still pictures and voices can be deleted on the built-in memory.

■ To delete the scenes, still pictures or voices being played back with this unit horizontally

1 Touch  while scenes, still pictures or voices to be deleted are being played back.

2 Touch [DELETE].

■ To delete scenes, still pictures or voices from the thumbnail display when using horizontally, or during playback when using vertically

1 (Only playing back horizontally)

Touch  during thumbnail display.

(Only playing back vertically)

Touch  .

2 Touch the item.

[SELECT]

(Only playing back horizontally)

Touch the scene, still picture or voice to be deleted.

- When touched, the scene, still picture or voice is selected and the indication appears on the thumbnail. Touch the scene, still picture or voice again to cancel the operation.
- Up to 100 scenes, still pictures or voices can be selected to be deleted.

[ALL]	When scenes or still pictures are selected, all the scenes or still pictures on the SD card/built-in memory will be deleted. When voices are selected, all the voices on the SD card/built-in memory will be deleted.
[SINGLE]	(Only playing back vertically) Delete the selected scene, still picture or voice.
[RETURN]	Deleting is cancelled.

3 (When [SELECT] or [ALL] are selected in step 2)

Touch [YES].

(When [SINGLE] is selected in step 2)

Touch [DELETE].

-
- Scenes, still pictures or voices protected on other products cannot be deleted.
 - The scenes, still pictures or voices that cannot be played back (with  on the thumbnail) may not be deleted.
 - In case of [ALL], the deletion may take time if there are many scenes/still pictures or voices.
 - If you delete scenes recorded on other products or still pictures conforming to DCF standard with this unit, all the data related to the scenes/still pictures may be deleted.
 - When still pictures recorded on an SD card by other products are deleted, a still picture (other than JPEG) that cannot be played back on this unit may be erased.

Creating still picture from motion picture

A single frame from the recorded motion picture can be saved as a still picture.

(Only playing back horizontally)

1 Touch  .

2 Touch  .

3 **Pause at the scene you want to save as a still picture during playback.**





- It is convenient to use frame-by-frame playback.

4 Touch  .

- Quality will be different from the normal still picture.

■ Picture size

Size of the still pictures will differ depending on the [Video Rec Mode] of the recorded scenes.

Recording mode	Size of still pictures
	2 M (1920×1080)
	0.9 M (1280×720)
	0.3 M (640×480)
	0.5 M (960×540)



To delete unwanted parts of a motion picture

You can delete unwanted parts of scenes.
(Only playing back horizontally)

1 Touch .

2 Touch .

3 Slide A or B while touching it to determine the unwanted part C.

- When you touch **A** or **B**,  appears. When you touch , you can advance or rewind frames.
- Touch [EXIT] to close the edit screen.

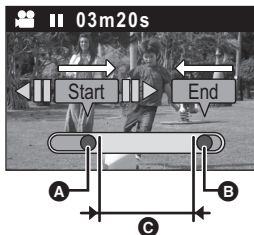

4 (To check the scene excluding C)

Touch .

- Playback operation during preview can be performed by touching playback bar.
- It will return to the previous screen when  is pressed.

5 Touch [ENTER].

6 Touch [ENTER].

- Touch [CANCEL] to return to the previous screen.

7 Touch the item.

[SAVE AS NEW]	It will store separately from the original scene.
[OVERWRITE]	Overwrites the original scene.
[DON'T SAVE]	Exit without deleting.

Setting of online sharing of motion pictures

You can easily upload to YouTube or Facebook when this unit is connected to the PC by setting up the upload destination of the motion pictures. (→ 61)

The PC for connection needs to have the HD Writer PE 2.0 installed and be connected to the Internet.

(Only playing back horizontally)

1 Touch .

- Proceed to step 3 during playback.

2 (When the thumbnail is displayed)

Touch the scene to be uploaded.

- When touched, the scene is selected and the indication appears on the thumbnail. (Up to 20 scenes can be selected.)
Touch the scene again to cancel the operation.
- Touch [ENTER].

3 Touch the upload destination.

- When touched, the icon is selected and the indication appears. Touch the icon again to cancel the operation.
- Touch [ENTER].

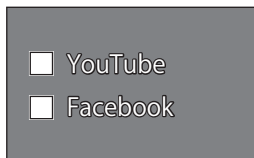



-
- The share setting will be automatically cancelled when the scene set for sharing is uploaded with the HD Writer PE 2.0.

Using the Setup menu screen

1 Touch  [MENU].

2 Touch  .

3 Touch the submenu **A**.

- To display the next (previous) page:
 - Touch  / .
 - Slide the submenu display upward (downward) while touching it.

4 Touch the desired item to enter the setting.

- Touch [EXIT] to exit the menu setting.

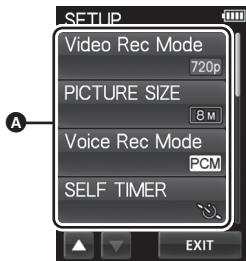



Menu list

[Video Rec Mode]

Switch the picture quality of the motion pictures to be recorded.



 [MENU] →  → [Video Rec Mode] → desired setting

 [1920×1080 30fps]/  [1280×720 30fps]/  [640×480 30fps]^{*1}:

Set the recording mode to MP4.

 [960×540 30fps]^{*2}:

Set the recording mode to iFrame.

*1 Recording will have higher quality in the order of ,  and .

*2 iFrame is a format suitable for Mac (iMovie'11). It is recommended when using a Mac.

• Please refer to page 24 for details about charging and motion pictures recording time.

• This function's default setting is .

• Please refer to page 92 for details about approximate recordable time.

- When the unit is moved a lot or moved quickly, or when a fast-moving subject is recorded (particularly when recording using [480p]), mosaic-type noise may appear at playback.

[PICTURE SIZE]

The higher the number of pixels, the higher the clarity of the picture when printing.

 [MENU] →  → [PICTURE SIZE] → desired setting

[8M] (3264×2448)/[2M] (1920×1080) [16:9]/[2M] (1600×1200)/
[0.3M] (640×480)

- This function's default setting is [8M].
- The recording will become longer depending on the recording pixels.
- Please refer to page 93 for details about the number of recordable pictures.

[Voice Rec Mode]

Select the recording quality.

 [MENU] →  → [Voice Rec Mode] → desired setting

[PCM] [High Quality]:

Set the recording mode to L-PCM.

[AAC] [256] [Standard 256kbps]/ [AAC] [128] [Long Time 128kbps]/

[AAC] [128Low] [Interview 128k LowGain]:

Set the recording mode to AAC.

- Voice recording modes are [PCM] , [AAC] [256] , [AAC] [128] / [AAC] [128Low] in order of high to low audio quality.
- [AAC] [128Low] is recommended that you use when interviewing.

- This function's default setting is [PCM] .
- Please refer to page 93 for details about approximate recordable time.

[SELF TIMER]





This is for recording scenes, still pictures or voices using the timer.

 [MENU] →  → [SELF TIMER] → desired setting

[OFF]: Cancel the setting

[2sec]: Records after 2 seconds

[10sec]: Records after 10 seconds

- When the Recording button is pressed or  is touched (In Voice Recording Mode only), a motion picture/still picture or voice is recorded after the 10 or 2 flashes for the time which has been set. After recording, the Self-timer is cancelled.
- When another operation is performed during countdown of the self-timer, the countdown will stop.
- Setting the Self-timer to 2 is a good way to prevent image shake when the Recording button is pressed or  is touched (In Voice Recording Mode only) while using a tripod etc.

[CLOCK SET]

Please refer to page 32.

[DATE FORMAT]



It is possible to change the date format.

 [MENU] →  → [DATE FORMAT] → desired setting

[Y / M / D]/[M / D / Y]/[D / M / Y]

[ALERT SOUND]

You can check the start and stop of recording, or turning the unit on/off with an audio tone.

 [MENU] →  → [ALERT SOUND] → [ON]

[HDMI resolution]

Select the desired method of HDMI output.

 [MENU] →  → [HDMI resolution] → desired setting

[AUTO]/[1080i]/[576p]/[480p]

- When [HDMI OUTPUT] is set to [50Hz], [576p] is displayed. When [HDMI OUTPUT] is set to [60Hz], [480p] is displayed.
- [AUTO] determines the output resolution automatically based on information from the recorded scene.

If the images are not output on the TV when the setting is [AUTO], switch to the method [1080i] or [576p]/[480p] which enables the images to be displayed on your TV. (Please read the operating instructions for the TV.)

[HDMI OUTPUT]



Output settings can be changed to match the environment in use when playing back connected to a TV.

 [MENU] →  → [HDMI OUTPUT] → desired setting

[50Hz]/[60Hz]

[FORMAT MEDIA]

Please be aware that if a medium is formatted, then all the data recorded on the medium will be erased and cannot be restored. Back up important data on a PC etc. (→ 61)

 [MENU] →  → [FORMAT MEDIA]

- When the confirmation message appears, select [YES].
-
- Do not turn this unit off or remove the SD card, while formatting. Do not expose the unit to vibrations or shock.
 - When formatting the built-in memory, start the formatting after removing the SD card.

Use this unit to format media.

Do not format an SD card using any other equipment such as a PC. The card may not be used on this unit.

[LANGUAGE]

You can select the language on the screen display and the menu screen.

 [MENU] →  → [LANGUAGE] → **desired setting**

Watching Motion/Still Pictures on your TV

- Use the HDMI mini cable (optional).

1 Connect this unit to a TV.

- The LCD monitor on this unit will turn off and the status indicator will flash.

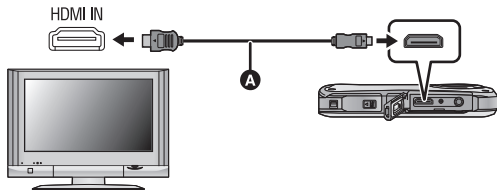

A HDMI mini cable (optional)

- Check that the plugs are inserted as far as they go.
- Always use a genuine Panasonic HDMI mini cable (RP-CDHM15, RP-CDHM30; optional).

2 Select the video input on the TV.

- Example:
Select the [HDMI] channel with a HDMI mini cable.
(The name of the channel may differ depending on the connected TV.)
- Check the input setting (input switch) and the audio input setting on the TV. (For more information, please read the operating instructions for the TV.)

3 Start playback on this unit.

Perform playback operations by touching the icons.

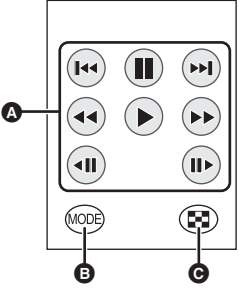
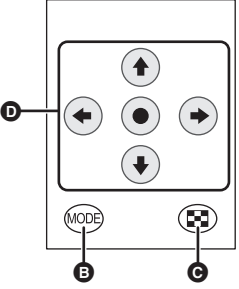
During playback/pause	During thumbnail display
	
<ul style="list-style-type: none">A Playback operations (→ 43)B Switching the modes (→ 45)C Thumbnail display (→ 44)D Up/down/left/right, Enter	

What you can do with a PC

- The unit comes with built-in HD Writer PE 2.0 video editing software.
- See page 66 for how to install HD Writer PE 2.0 on your PC.

HD Writer PE 2.0

You can copy the motion/still picture data to the HDD of PCs or write to SD cards using the HD Writer PE 2.0 software.

Refer to the operating instructions of HD Writer PE 2.0 (PDF file) for details on how to use it.

■ Smart wizard

The Smart wizard screen is automatically displayed when you connect this unit to a PC with HD Writer PE 2.0 installed. (→ 68)



- Select the function you wish to use and follow the on-screen instructions for easy copying and uploading motion pictures on the Internet.
- When there are scenes set to online sharing, the upload screen will be displayed.

Available function using HD Writer PE 2.0	Data type
Copying data to a PC	Motion picture and still picture
Playing back on a PC	
Online sharing: You can upload motion pictures on the Internet and share them with your family and friends. <ul style="list-style-type: none"> • The upload screen is automatically displayed with the linking function with the HD Writer PE 2.0 when there are any scenes that are set for sharing in this unit. 	Motion picture
Editing: Editing motion picture data copied on an HDD of a PC <ul style="list-style-type: none"> • Title, Transition, Delete partially, Divide Scene • Converting part of motion picture into still picture 	

- Voices recorded with this unit can be played back on a PC using QuickTime (Ver. 7 or later) or copied to a PC using Windows Explorer.
- Playing back still pictures on a PC using standard Windows picture viewer or a commercially available picture viewer, or copying still pictures to a PC using Windows Explorer is available.
- Refer to page 72 if using a Mac.

Important Notice

- **When using an SDXC Memory Card, check the following support site.**
<http://panasonic.net/avc/sdcard/information/SDXC.html>

-
- **Motion pictures that have been recorded on another device cannot be written to HD Writer PE 2.0.**

(EB/EP only)

- We cannot guarantee operation if you use software other than HD Writer PE 2.0 to read motion picture.

(GC/GN only)

- We cannot guarantee operation if you use software other than HD Writer PE 2.0 to read/write motion picture.
- Do not start HD Writer PE 2.0 and other software at the same time. Close any other software if you start HD Writer PE 2.0 and close HD Writer PE 2.0 if you start any other software.

Operating environment

- Even if the system requirements mentioned in these operating instructions are fulfilled, some PCs cannot be used.
- Operation is not guaranteed in the following cases.
 - When 2 or more USB devices are connected to a PC, or when devices are connected through USB hubs or by using extension cables other than the supplied USB extension cord.
 - Operation on an upgraded OS.
 - Operation on an OS other than the one pre-installed.
- This software is not compatible with Microsoft Windows 3.1, Windows 95, Windows 98, Windows 98SE, Windows Me, Windows NT and Windows 2000.

■ Operating environment for HD Writer PE 2.0

PC	IBM PC/AT compatible PC
OS	Windows 7 (32 bit/64 bit) Starter/Home Basic/Home Premium/Ultimate/Professional or SP1 Windows Vista (32 bit) Home Basic/Home Premium/Business/Ultimate SP1/SP2 Windows XP (32 bit) SP3
CPU	Intel Pentium 4 2.8 GHz or higher <ul style="list-style-type: none"> ● Intel Core 2 Duo 2.16 GHz or higher or AMD Athlon 64 X2 Dual-Core 5200+ or higher is recommended when a playback function is used. ● Intel Core 2 Quad 2.6 GHz or higher is recommended when using the editing function.
RAM	Windows 7: 1 GB or more (32 bit)/ 2 GB or more (64 bit) Windows Vista: 1 GB or more Windows XP: 512 MB or more (1 GB or more recommended)

Display	High Colour (16 bit) or more (32 bit or more recommended) Desktop resolution of 1024×768 pixels or more (1920×1080 pixels or more recommended) Windows 7/Windows Vista: DirectX 9.0c compatible video card (DirectX 10 recommended) Windows XP: DirectX 9.0c compatible video card Compatible with DirectDraw overlay PCI Express™ ×16 compatible recommended Video memory of 256 MB or more recommended
Free hard disk drive space	Ultra DMA — 100 or more 450 MB or more (for installing the software)
Sound	DirectSound Support
Interface	USB port [Hi-Speed USB (USB 2.0)]
Other requirements	Mouse or equivalent pointing device Internet connection

- Input is not supported in languages other than English, German, French, Simplified Chinese and Russian.
 - Operation is not guaranteed on Microsoft Windows Vista Enterprise, Windows XP Media Center Edition, Tablet PC Edition and Windows 7 Enterprise.
 - This software is not compatible with a multi-boot environment.
 - This software is not compatible with a multi-monitor environment.
 - If using Windows XP, an administrative account user only can use this software. If using Windows Vista/Windows 7, administrative account and standard account users only can use this software. (An administrative account user should install and uninstall this software.)
-
- Operation during the playback may become slow if the CPU or memory is not fulfilling the requirements of the operating environment.
 - Always use the most current driver for the video card.
 - Always make sure there is enough capacity on the HDD in the PC. It may become inoperable or the operation may stop suddenly if the capacity gets low.

■ Operating environment for the card reader function (mass storage)

PC	IBM PC/AT compatible PC
OS	Windows 7 (32 bit/64 bit) or SP1 Windows Vista (32 bit) (SP1/SP2) Windows XP (32 bit) (SP3)
CPU	Windows 7/Windows Vista: 1.0 GHz or higher 32-bit (x86) or 64-bit (x64) processor Windows XP: Intel Pentium III 450 MHz or higher or Intel Celeron 400 MHz or higher
RAM	Windows 7: 1 GB or more (32 bit)/ 2 GB or more (64 bit) Windows Vista Home Basic: 512 MB or more Windows Vista Home Premium/Business/ Ultimate/Enterprise: 1 GB or more Windows XP: 128 MB or more (256 MB or more recommended)
Interface	USB port
Other requirements	Mouse or equivalent pointing device

- The USB equipment operates with the driver installed as standard in the OS.

Installation

When installing the software, log on to your computer as the Administrator or with a user name with equivalent authorization. (If you do not have authorization to do this, consult your manager.)

- Before starting the installation, close all applications that are running.
- Do not perform any other operations on your PC while the software is being installed.
- Explanation of operations and screens is based on Windows 7.
- Turn on the unit.

1 Connect USB terminal of this unit to a PC with a USB extension cord.

- Do not use any other USB extension cords except the supplied one. (Operation is not guaranteed with any other USB extension cords.)

2 Touch [PC] on the screen of this unit.

- The following screen is displayed automatically. Click [HD Writer PE 2.0] → [Yes].
- When using Windows 7 or if the following screen is not displayed automatically, select [Start] → [Computer] (or double-click on [Computer] on the desktop), and then double-click [HD Writer PE]^{*} → [setup(.exe)].

* Depending on the PC you are using, [CAM_APP] may be displayed.

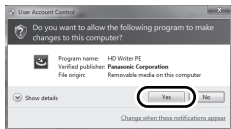

3 Click [Next].

4 Read the [End User License Agreement], then place a check beside [I accept the terms of the license agreement] if you agree to them and click [Next].

5 Select where the application is to be installed, then click [Next].

6 Select [Yes] or [No] to create shortcut.



7 When installation is complete, some notes will appear. Check the contents, then close the window.

8 Select [Yes, I want to restart my computer now.], then click [Finish].



The PC must be rebooted for the application to work.

■ Uninstalling HD Writer PE 2.0

Follow the steps below to uninstall any software applications that you no longer require.

1 Select [Start] → [Control Panel] → [Uninstall a program].

2 Select [HD Writer PE 2.0], then click [Uninstall].

- Proceed with the uninstallation by following the on-screen instructions.
- After uninstalling the software, be sure to reboot the PC.

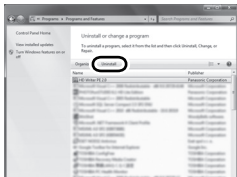

Connecting to a PC

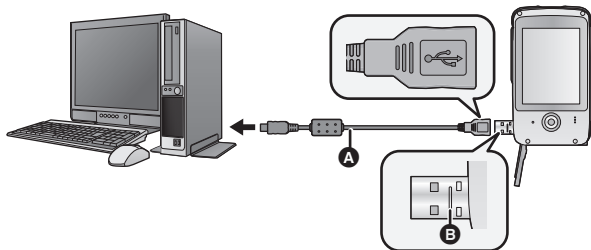

A USB extension cord (supplied)

- Turn on the unit.

1 Connect USB terminal of this unit to a PC with a USB extension cord.

- Do not use any other USB extension cords except the supplied one. (Operation is not guaranteed with any other USB extension cords.)
- Insert the USB extension cord securely all the way. (Insert to the line **B**.) It will not operate properly if it is not inserted all the way.

2 Touch [PC] on the screen of this unit.

- The LCD monitor turns off.
- The Smart wizard screen is automatically displayed when HD Writer PE 2.0 is installed.
- When there are scenes set to online sharing, the upload screen will be displayed.
- This unit is automatically recognised as an external drive of the PC. (→ 70)

-
- Do not disconnect the USB terminal of this unit while the status indicator is on.
 - When performing reading/writing between a PC and an SD card, be aware that some SD card slots built into PCs and some SD card readers are not compatible with the SDHC Memory Card or SDXC Memory Card.
 - When using an SDXC Memory Card, check the following support site.
<http://panasonic.net/avc/sdcard/information/SDXC.html>
 - Operation is not guaranteed for all devices equipped with a USB terminal.

■ To disconnect USB terminal of this unit safely

Select the  icon in task tray displayed on the PC, and then click [Eject Panasonic Mobile Camera].

- Depending on your PC's settings, this icon may not be displayed.

About the PC display

When the unit is connected to a PC, it is recognised as an external drive.

- Removable disk (Example:  CAM_SD (G:)) is displayed in [Computer].

(EB/EP only)

We recommend using HD Writer PE 2.0 to copy motion picture data.

(GC/GN only)

We recommend using HD Writer PE 2.0 to copy or write back motion picture data.

Using Windows Explorer or other programmes on the PC to copy, move or rename files and folders recorded with this unit will result in them being unusable with HD Writer PE 2.0.

Example folder structure of an SD card:

- Up to a total of 999 files of motion pictures, still pictures and voices can be saved in a single folder.
- Recorded scenes.
- JPEG format still pictures
- Recorded voices

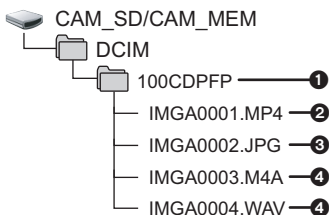

■ Copying your still pictures to your PC

Card reader function (mass storage)

Still pictures recorded with this unit can be copied to the PC with Explorer or other programmes.

- Double click the folder that contains the still pictures. ([DCIM] → [100CDPFP] etc.)
- Drag and drop the still pictures onto the destination folder (on the PC's HDD).

- Do not delete the SD card's folders. Doing so may make the SD card unusable in this unit.
- When data not supported by this unit has been recorded on a PC, it will not be recognised by this unit.
- Always use this unit to format SD cards.

Starting HD Writer PE 2.0

- To use the software, log on as an Administrator or as user name for standard user account (only for Windows 7/Windows Vista).
The software cannot be used with the user name for a guest account.

(On the PC)

Select [Start] → [All Programs] → [Panasonic] → [HD Writer PE 2.0] → [HD Writer PE].

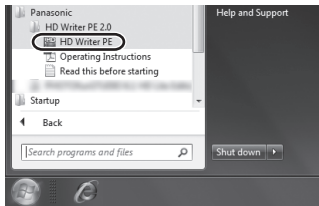

- For details on how to use the software applications, read the PDF operating instructions of the software.

Reading the operating instructions of the software applications

- You will need Adobe Acrobat Reader 5.0 or later or Adobe Reader 7.0 or later to read the PDF operating instructions.

Select [Start] → [All Programs] → [Panasonic] → [HD Writer PE 2.0] → [Operating Instructions].

If using Mac

- HD Writer PE 2.0 is not available for Mac.
- iMovie'11 supported. For details about iMovie'11, please contact Apple Inc.

■ Operating environment

PC	Mac
OS	Mac OS X 10.6.6
CPU	Intel Core Duo or better
RAM	1 GB or more
Interface	USB port

- Even if the system requirements mentioned in these operating instructions are fulfilled, some PCs cannot be used.
- The USB equipment operates with the driver installed as standard in the OS.

■ Copying still pictures on PC

- Turn on the unit.

1 Connect USB terminal of this unit to a PC with a USB extension cord.

- Do not use any other USB extension cords except the supplied one.
(Operation is not guaranteed with any other USB extension cords.)

2 Touch [PC] on the screen of this unit.

3 Double-click [CAM_SD] or [CAM_MEM] displayed on the desktop.

- Files are stored in [100CDPFP] folder etc. in the [DCIM] folder.

4 Using a drag-and-drop operation, move the pictures you want to acquire or the folder storing those pictures to any different folder on the PC.

■ To disconnect USB terminal of this unit safely

Drag [CAM_SD] or [CAM_MEM] disk icon to the [Trash], and then disconnect the USB terminal of this unit.

To use as a camera for Skype

It is possible to perform video conferencing using Skype when this unit is connected to a PC that is connected to the Internet.

Skype is a software that allows you to perform video conferencing using an Internet connection.

- Skype must first be installed before use.
- For downloading or details regarding Skype, refer to the Skype Website.
- For information on how to use Skype, refer to the Skype help file.
- Depending on the PC or Internet environment used, you may not be able to use Skype, images may be disrupted, cut off, the resolution may be low or the audio may be cut off.
- A higher performance CPU is recommended for high-quality video conferencing.

■ Operating environment for Skype

	PC	
	IBM PC/AT compatible PC	Mac
Software	Skype 5.1 for Windows	Skype 5.0 for Mac OS X
OS	Windows 7 (32 bit/64 bit) or SP1 Windows Vista (32 bit) (SP1/SP2) Windows XP (32 bit) (SP3)	Mac OS X 10.6.6
CPU	Intel Core 2 Duo 1.8 GHz or higher 32-bit (x86) or 64-bit (x64) processor	Intel Core 2 Duo 1.8 GHz or higher
RAM	Windows 7: 1 GB or more (32 bit)/2 GB or more (64 bit) Windows Vista Home Basic: 512 MB or more Windows Vista Home Premium/Business/ Ultimate/Enterprise: 1 GB or more Windows XP: 512 MB or more	512 MB or more
Free hard disk drive space	100 MB free disk space	
Sound	Speaker or headphones	
Interface	USB port	
Other requirements	High-speed broadband Internet connection of 4 Mbps down/512 kbps up	

- Even if the system requirements mentioned in these operating instructions are fulfilled, some PCs cannot be used.
- This software is not compatible with Microsoft Windows 3.1, Windows 95, Windows 98, Windows 98SE, Windows Me, Windows NT and Windows 2000.
- Operation on an upgraded OS is not guaranteed.
- Operation on an OS other than the one pre-installed is not guaranteed.

How to connect

- Turn on the unit.

1 Connect USB terminal of this unit to a PC with a USB extension cord.

- Connect the USB extension cord by inserting it securely all the way without forcing.

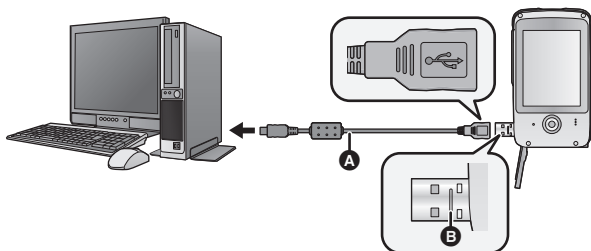

- A USB extension cord (supplied)
- Do not use any other USB extension cords except the supplied one. (Operation is not guaranteed with any other USB extension cords.)
- Insert the USB extension cord securely all the way. (Insert to the line B.) It will not operate properly if it is not inserted all the way.

2 Touch [WEB CAMERA] on the screen of this unit.

3 (On a PC)

Start Skype.

- Check this unit is selected with the Skype settings.
- The image quality will automatically vary among 640×480, 320×240 and 160×120 depending on the internet environment.
- When disconnecting the USB terminal of the unit from your PC, shut down Skype before disconnecting.

-
- Operation is not guaranteed for all devices equipped with a USB terminal.

Indications

■ Recording indications

Motion pictures

Still pictures

Voices

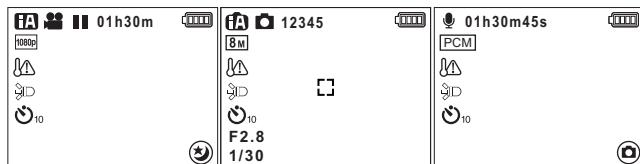

1080p / 720p / 480p / iFrame

Video Rec Mode (→ 54)

● Recording motion picture

|| Recording pause (motion picture)

FA / FA / FA / FA / FA / Intelligent Auto Mode (→ 38)
 FA / FA / FA

01h30m Remaining time for motion picture or voice recording (→ 35, 37)

00m00s Elapsed recording time for motion pictures (→ 35)

00h00m00s Elapsed recording time for voices (→ 37)

● “h” is an abbreviation for hour, “m” for minute and “s” for second.

15s Countdown until recording stops (→ 30, 35)

LED High temperature warning (→ 39)

High temperature warning (→ 30)

Remaining battery power (→ 25)

White Recording pause (still picture)

Red Recording still picture









White Recording pause (voice)

Red Recording voice

8M / 2M / 2M / 0.3M Number of recording pixels for still pictures (→ 55)

PCM / AAC 256 /
AAC 128 / AAC 128Low

Voice Rec Mode (→ 55)







12345	Remaining number of recordable pictures (→ 36)
	Focus area (→ 36)
 10 / 2	Self-Timer Recording (→ 56)
F2.8	Iris value
1/30	Shutter speed
 /  / 	Effect icon (→ 40)
 / 	Night View mode (→ 40)
 / 	Recording still pictures during voice recording (→ 37)

■ Playback indications

Motion pictures

Still pictures

Voices

 ▶ 00m00s 	 	 ▶ 01h30m45s 
100-0001 15.11.2011 12:34	100-0001 15.11.2011 12:34	100-0001 15.11.2011 12:34



Motion picture icon (→ 42)



Still picture icon (→ 42)



Voice icon (→ 42)



Motion picture set for online sharing (→ 53)



Display during playback (→ 43)



Playing back the slide show/continuous playback (→ 47)



Protected motion pictures/still pictures/voices (→ 50)

00m00s	Playback time for motion pictures (→ 45)
00h00m00s	Playback time for voices (→ 45)
100-0001	File number (→ 45)
15. 11. 2011 12:34	Date/Time indication (→ 32)

■ Confirmatory indications



SD card is not inserted or is non-compatible.

Messages/Troubleshooting

■ Messages

Major confirmation/error messages to be indicated on the screen in text.

Incompatible card. Please check card.

This card is not compatible or it cannot be recognised by the unit.
If this message appears even though motion pictures, still pictures and voices are recorded on an SD card, the card may be unstable.
Reinsert the SD card, then turn the unit off and then on again.

■ Troubleshooting

Problem

This unit cannot be turned on.

This unit does not stay on long enough.

Battery runs down quickly.



This unit cannot be operated though it is turned on.

This unit does not operate normally.



Check points

- Charge the battery again to ensure it is sufficiently charged. (→ 21)
- In cold places, the battery using time becomes shorter.
- The battery has a limited life. If the operating time is still too short even after the battery is fully charged, the battery has worn out and needs to be replaced. Contact Panasonic's Service Center.

- Press the RESET button with the stylus pen. (→ 82) Then about 1 minute later, turn on the unit again. (Conducting the above operation while the SD card is being accessed may damage the data on the SD card.)
- If normal operation is still not restored, consult the dealer who you purchased this unit from.

Problem

Check points

The unit arbitrarily stops recording.



- Use an SD card that can be used for motion picture recording. (→ 26)
- The recordable time may have shortened due to the deterioration of the data writing speed or repeated recording and deletion. Using the unit, format the SD card. (→ 58)

Scenes, still pictures or voices cannot be played back.



- Any scenes, still pictures or voices where the thumbnails are displayed as  cannot be played back.

Although this unit is correctly connected to a TV, images cannot be seen.



- Please read the operating instructions of your TV and select the channel that matches the input used for the connection.
- Check the setting of [HDMI resolution]. (→ 57)

Scenes, still pictures or voices cannot be deleted.



- Any scenes, still pictures or voices where the thumbnails are displayed as  cannot be deleted. If the scenes, still pictures or voices are unnecessary, format the SD card to erase the data. (→ 58) Please be aware that if an SD card is formatted then all the data recorded on the SD card is erased and cannot be recovered. Back up important data on a PC etc.

If the SD card is inserted in this unit, it is not recognised.



- If the SD card is formatted on a PC, it may not be recognised by this unit. Use this unit to format SD cards. (→ 58)

Problem

If the SD card is inserted in another device, it is not recognised.



- Check that the device is compatible with the capacity or type of SD card (SD Memory Card/SDHC Memory Card/SDXC Memory Card) that you inserted. Refer to the operating instructions of the device for details.

Colour or brightness of the image changes, or you may see horizontal bars in the image.



- Colour or brightness of the image may change, or you may see horizontal bars in the image when the object is recorded under fluorescent light, mercury light or sodium light, etc., but this is not a malfunction.

The LCD monitor flickers indoors.

“Error occurred. Please turn unit off, then turn on again.” is displayed.



- The unit has automatically detected an error. Restart the unit by turning off and on.
- Press the RESET button with the stylus pen. (→ 82)
- Repair is needed if it is repeatedly displayed even if it is restarted. Consult the dealer who you purchased this unit from. Do not attempt to repair the unit by yourself.

Problem

When connected by the USB terminal, this unit is not detected by the PC.



- After re-inserting the SD card into the unit, reconnect the USB terminal of this unit.
- Select another USB terminal on the PC.
- Check the operating environment. (→ 63, 72, 73)
- Connect the USB terminal of this unit again after restarting the PC and turning on this unit again.

Cannot see the PDF operating instructions for HD Writer PE 2.0.



- You will need Adobe Acrobat Reader 5.0 or later or Adobe Reader 7.0 or later to read the PDF operating instructions for HD Writer PE 2.0.

When using Skype, the image/audio is cut off.



- Reconnect the USB terminal of this unit after shutting down Skype, and connect to Skype again.

About the RESET button

Use the stylus pen, when you press the RESET button.

HM-TA20

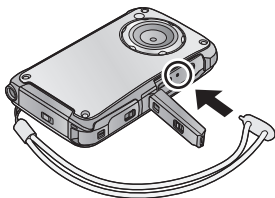

HM-TA2

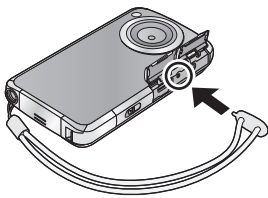

Cautions for use

(For Australia and New Zealand)

In the event of abnormal operation (e.g. if the unit emits smoke or an unusual smell), immediately stop operating the unit and consult the Panasonic Customer Care Centre on 132600.

About this unit

The unit and the SD card become warm during use. This is not a malfunction.

Do not drop or bump the unit. Do not subject to strong pressure.

- A strong impact can break the lens, LCD monitor or the unit's casing, causing it to malfunction.
- Do not attach any other items to the hand strap that's supplied with the unit. While being stored, that item can rest against the LCD monitor and damage it.
- While the unit is stored in a bag, be careful not to drop or hit the bag so that the unit may not be subjected to impact.

Keep this unit as far away as possible from electromagnetic equipment (such as microwave ovens, TVs, video games etc.).

- If you use this unit on top of or near a TV, the pictures and/or sound on this unit may be disrupted by electromagnetic wave radiation.
- Do not use this unit near cell phones because doing so may result in noise adversely affecting the pictures and/or sound.
- Recorded data may be damaged, or pictures may be distorted, by strong magnetic fields created by speakers or large motors.
- Electromagnetic wave radiation generated by microprocessors may adversely affect this unit, disturbing the pictures and/or sound.
- If this unit is adversely affected by electromagnetic equipment and stops functioning properly, turn this unit off and press the RESET button. Then turn this unit on.

Do not use this unit near radio transmitters or high-voltage lines.

- If you record near radio transmitters or high-voltage lines, the recorded pictures and/or sound may be adversely affected.

Make sure to use the supplied cords. If you use optional accessories, use the cords and the cables supplied with them.

Do not extend the cords and the cables.

Do not spray insecticides or volatile chemicals onto the unit.

- If the unit is sprayed with such chemicals, its body may be marred and the surface finish may peel off.
- Do not leave rubber or plastic products in contact with the unit for a long time.

When you use the unit in a sandy or dusty place such as a beach, do not let sand or fine dust get into the body and terminals of the unit.

- Sand or dust may damage the unit. (Care should be taken when inserting and removing a card.)

HM-TA2

Keep the unit away from sea water.

- If sea water splashes onto the unit, wipe off the water with a well wrung cloth. Then wipe the unit again with a dry cloth.

Do not use the unit for surveillance purposes or other business uses.

- In certain situations, continuous use could cause the unit to overheat and cause a malfunction. Such use is strongly discouraged.
- This unit was designed for consumer intermittent use. It was not intended for continuous use, or for any industrial or commercial application resulting in prolonged use.

Perform a formatting of the built-in memory when this unit is to be disposed/transferred. (→ 58)

About status indicator during charging

When the status indicator is flashing at a particularly fast rate, the following should be considered.

Flashing with approx. 2 second period (off for approx. 1 second, on for approx. 1 second):

- The battery is not charged. Press the RESET button, and try charging again.
- Check that the terminals of the unit are not dirty or covered with a foreign object, and connect this unit correctly once again. If a foreign object or dirt is present, turn off the unit and then remove it.

- The battery or environment is at an extremely high or low temperature. Wait until the temperature has returned to an appropriate level and try charging again. If you are still unable to charge, there may be a fault in this unit.

Cleaning

When cleaning, wipe this unit with a soft, dry cloth.

- If the unit is very dirty, dip a cloth in water and squeeze firmly, and then wipe the unit with the damp cloth. Next, dry the unit with a dry cloth.
- Use of benzine, paint thinner, alcohol, or dishwashing liquid may alter the unit body or peel the surface finish. Do not use these solvents.
- When using a chemical dust cloth, follow the instructions that came with the cloth.

LCD monitor

- Do not press the LCD monitor with excessive force. Uneven colours may appear on the LCD monitor and it may malfunction.
- When the LCD monitor gets dirty, wipe it with a soft cloth such as eye glass cleaner.
- Do not touch the LCD monitor with your finger nails, or rub or press with strong force.
- It may become hard to see or hard to recognise the touch when the LCD protection sheet is affixed.
- In a place with drastic temperature changes, condensation may form on the LCD monitor. Wipe it with a soft cloth such as eye glass cleaner.
- When the unit has become very cold, for example due to storage in a cold area, its LCD monitor will be slightly darker than usual immediately after the unit is turned on. The normal brightness will be restored when the unit's internal temperature rises.

Extremely high precision technology is employed to produce the LCD Monitor screen featuring a total of approximately 230,000 dots. The result is more than 99.99% effective dots with a mere 0.01% of the dots inactive or always lit. However, this is not a malfunction and does not affect the recorded picture.

About the Lens, the microphone and the speaker

- Do not press against the lens with excessive force.
- Do not leave the unit with the lens facing the sun, as rays of light from the sun may cause it to malfunction. Also, be careful when placing the unit outside or near a window.
- If the lens gets dirty with fingerprints etc., wipe the lens surface with a soft dry cloth.
(If you leave fingerprints on or otherwise dirty the lens, the pictures you take may look whiter than normal.)

HM-TA20

- A sound might be muffled or warped when there is water on the microphone or the speaker. Wipe the residues after letting the water drip out from the microphone and speaker by tipping this unit downward, and use it after letting it dry for a while.
- Do not poke the holes of microphone and speaker with sharp points. (It may damage the waterproof sheet inside, which may damage the waterproof performance.)

About the battery

The battery used in this unit is a rechargeable lithium-ion battery. It is susceptible to humidity and temperature and the effect increases the more the temperature rises or falls.

If the operating time is very short even after the battery has been recharged, the battery has worn out. Consult the dealer who you purchased this unit from.

About the SD card

- The memory capacity indicated on the label of an SD card is the total of the capacity for copyright protection and management and the capacity which can be used on the unit, a PC etc.

Do not leave the SD card where the temperature is high, where electromagnetic waves or static electricity are easily generated or exposed to direct sunlight.

Do not bend or drop the SD card.

- The SD card may be damaged or the recorded content may be damaged or deleted.
- Put the SD card in the card case or the storage bag after use and when storing or carrying the SD card.
- Do not allow dirt, dust or water to get into the terminals on the back of the SD card and do not touch the terminals with your fingers.

When disposing of or giving away the SD card, note that:

Formatting and deletion of this unit or computer only changes the file management information and does not completely delete the data in the SD card.

It is recommended to physically destroy the SD card or use the commercially available computer data deletion software to completely erase the data in the SD card before transferring to another party or disposing.

The customer is responsible for the management of the data in the SD card.

When not using the unit for a long period of time

- This unit should be stored in a cool place free from humidity, with as constant temperature as possible. (Recommended temperature: 15 °C to 25 °C, Recommended humidity: 40%RH to 60%RH)
- Always remove the SD card from the unit.
- When storing this unit for a long period of time, we recommend charging it once a year.
- The battery will self-discharge little by little even when this unit is not used. The battery may get exhausted when you do not use it for a long period of time.
- When storing the unit in a cupboard or cabinet, it is recommended that you place a desiccant (silica gel) in with it.

About condensation

- Condensation occurs when the ambient temperature or humidity changes. Be careful of condensation since it causes lens stains, fungus and unit malfunction.
- If condensation occurs, turn the unit off and leave it for about 2 hours. The fog will disappear naturally when the temperature of the unit becomes close to the ambient temperature.

Requests when disposing of this unit

When disposing of your used products, remove the battery built into the unit, and please cooperate in recycling of the battery.

Please refer to page 89 about how to remove the battery.

- Please make sure that the battery is disposed of at an officially assigned location, if there is one in your country.

Do not disassemble this unit other than when disposing of this unit.

This is the rechargeable battery for this unit. Do not use other than with this unit.

Do not charge the rechargeable battery when it has been removed.

- Do not place in fire or heat it.
- Do not puncture with nails, subject it to impact, disassemble or modify it.
- Do not touch metal to the + and – terminals.
- Do not store or carry together with necklaces or hairpins, etc.
- Do not heat in microwaves or ovens, etc.
- Do not charge, use or leave in hot places such as next to fires or in extremely hot weather.
- Do not put into water.

This may cause leaking, overheating, fire or rupture.

- If a leak should occur, by no means touch the liquid with bare hands. If the liquid gets on the body or clothes, wash well with water. If the liquid gets into your eyes, there is a danger of blindness. Do not rub the eyes; after washing immediately with clean water, consult your physician.

Keep removed screws etc. out of the reach of small children.

If accidentally ingested there will be adverse physical effects.

- Should you suspect that such an object has been ingested, consult your physician immediately.

Battery used for this unit

Name: Lithium ion (Li-ion) rechargeable battery

Nominal voltage: DC 3.7 V

How to remove the battery

Disassemble after the battery runs out.

This figure describes the disposal of the unit, it is not instruction for repair. If disassembled, repair is not possible.

- Using a driver (optional), disassemble in the following sequence.
- If it cannot be removed smoothly, contact Panasonic's Service Center.
- Keep disassembled parts out of reach of children.

1 Remove all screws shown in the figure.

(**HM-TA20**) : 9 screws, (**HM-TA2**) : 7 screws)

- Use a Phillips screwdriver (optional) to remove screws.

HM-TA20

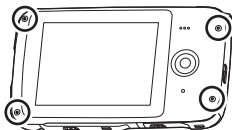
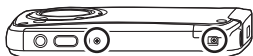

HM-TA2

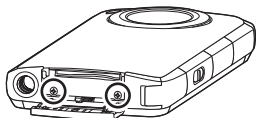
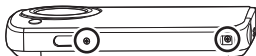

2 Open this unit as shown in the figure below, and remove the battery with a driver.

HM-TA20

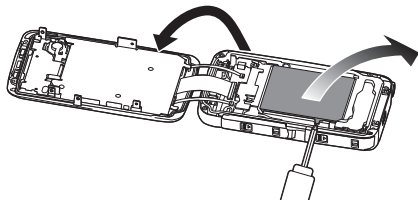

HM-TA2

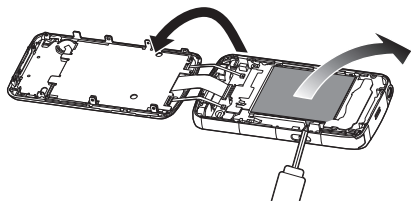

Regarding the handling of used batteries

- Insulate the terminals with cellophane tape or similar.
- Do not disassemble.

About copyright

■ Carefully observe copyright laws

Recording of pre-recorded tapes or discs or other published or broadcast material for purposes other than your own private use may infringe copyright laws. Even for the purpose of private use, recording of certain material may be restricted.

■ Licenses

- SDXC Logo is a trademark of SD-3C, LLC.
- HDMI, the HDMI Logo, and High-Definition Multimedia Interface are trademarks or registered trademarks of HDMI Licensing LLC in the United States and other countries.
- Microsoft[®], Windows[®] and Windows Vista[®] are either registered trademarks or trademarks of Microsoft Corporation in the United States and/or other countries.
- Microsoft product screen shot(s) reprinted with permission from Microsoft Corporation.
- IBM and PC/AT are registered trademarks of International Business Machines Corporation of the U.S.
- Intel[®], Core[™], Pentium[®] and Celeron[®] are the registered trademarks or trademarks of Intel Corporation in the United States and other countries.
- AMD Athlon[™] is a trademark of Advanced Micro Devices, Inc.
- iMovie and Mac are trademarks of Apple Inc., registered in the U.S. and other countries.
- YouTube is a trademark of Google Inc.
- Facebook is a trademark of Facebook Inc.
- Other names of systems and products mentioned in these instructions are usually the registered trademarks or trademarks of the manufacturers who developed the system or product concerned.

This product is licensed under the AVC patent portfolio license for the personal and non-commercial use of a consumer to (i) encode video in compliance with the AVC Standard ("AVC Video") and/or (ii) decode AVC Video that was encoded by a consumer engaged in a personal and non-commercial activity and/or was obtained from a video provider licensed to provide AVC Video. No license is granted or shall be implied for any other use. Additional information may be obtained from MPEG LA, LLC. See <http://www.mpegla.com>.

Recording modes/approximate recordable time (motion pictures)

- SD cards are only mentioned with their main memory size. The stated times are the approximate recordable times for continuous recording.



Recording mode		1080p	720p	480p	iFrame
Picture size		1920×1080	1280×720	640×480	960×540
SD card	4 GB	40 min	50 min	2 h 20 min	20 min
	16 GB	2 h 40 min	3 h 30 min	9 h 50 min	1 h 20 min
	64 GB	10 h	13 h 30 min	32 h	5 h 20 min
Built-in memory Approx. 10 MB		3 s	4 s	13 s	2 s

- A** Favors image quality
 - B** Favors recording time
 - C** Use this to playback and edit using a Mac.
- The default setting is 720p .
 - Maximum continuous recordable time for one scene:
 - If [Video Rec Mode] is set to 1080p / 720p / 480p :
29 min 59 sec
 - If [Video Rec Mode] is set to iFrame :
Approx. 20 min (up to 4 GB recording capacity)
 - If a recording with a lot of action is recorded, the recording time is reduced.
 - The recordable time may be reduced if recording of short scene is repeated.

Approximate number of recordable pictures

- SD cards are only mentioned with their main memory size. The stated number is the approximate number of recordable pictures.

Aspect ratio		4:3			16:9
Picture size		8M 3264×2448	2M 1600×1200	0.3M 640×480	2M 1920×1080
SD card	4 GB	1400	5400	23900	5200
	16 GB	5800	22100	97600	21200
	64 GB	23500	82300	247100	82300
Built-in memory Approx. 10 MB		4	16	71	15

Recording modes/approximate recordable time (voices)

- SD cards are only mentioned with their main memory size. The stated times are the approximate recordable times for continuous recording.

Recording mode		PCM	AAC 256	AAC 128 / AAC 128Low
File format		L-PCM	256 kbps AAC	128 kbps AAC/ 128 kbps AAC LowGain
SD card	4 GB	5 h 30 min	32 h	62 h 20 min
	16 GB	22 h	131 h 10 min	254 h 50 min
	64 GB	91 h	532 h	1033 h
Built-in memory Approx. 10 MB		30 s	3 min	7 min

- The default setting is **PCM**.
- Maximum continuous recordable time for one voice:
Approx. 5 h (up to 4 GB recording capacity)
- The recordable time may be reduced if short recording is repeated.

Specifications

High Definition Mobile Camera

Information for your safety

Power source:

DC 5.0 V (When using USB)/DC 3.7 V (When using battery)

Power consumption:

Recording; 2.6 W/Charging; 2.5 W

Signal system:

1080/30p, 720/30p, 540/30p, 480/30p

Recording format:

MPEG-4 AVC file format compliant (.MP4)

Image sensor:

1/4 type (1/4") MOS image sensor

Total; 5330 K

Effective pixels;

Motion picture; 2930 K (16:9), 2190 K (4:3)

Still picture; 2930 K (16:9), 5080 K (4:3)

Lens:

F2.8

Focal length; 4.1 mm

35 mm equivalent;

Motion picture; 49 mm (16:9)/59 mm (4:3)

Still picture; 49 mm (16:9)/39 mm (4:3)

Minimum focus distance;

Motion pictures; Approx. 30 cm

Still pictures; Approx. 10 cm

Zoom:

1× Optical Zoom, 4× Digital Zoom

Monitor:

7.5 cm (3.0") LCD monitor (Approx. 230 K dots)

Microphone:

Stereo

Speaker:

1 round speaker, dynamic type

White balance adjustment:

Auto tracking white balance system

Standard illumination:

1,400 lx

Minimum required illumination:

Approx. 9 lx (1/30)

HDMI mini connector video output level:

HDMI™ 1080i/576p/480p

HDMI mini connector audio output level:

Linear PCM

Headphone output:

10 mW+10 mW, 16 Ω (Stereo mini jack)

USB:

(EB/EP only)

Card reader function (No copyright protection support)

(GC/GN only)

Card reader/writer function (No copyright protection support)

Hi-Speed USB (USB 2.0), USB terminal Type A

Battery charging function (charge via USB terminal with the unit turned off)

WEB camera;

Compression; Motion JPEG

Picture size; 640×480, 320×240, 160×120

Dimensions:

HM-TA20

64.3 mm (W)×112.6 mm (H)×17.7 mm (D) (excluding projecting parts)

HM-TA2

59.8 mm (W)×108.9 mm (H)×16.9 mm (D) (excluding projecting parts)

Mass in operation:

HM-TA20

Approx. 155 g [with an SD card (optional)]

HM-TA2

Approx. 144 g [with an SD card (optional)]

Mass:

HM-TA20

Approx. 153 g [without an SD card (optional)]

HM-TA2

Approx. 142 g [without an SD card (optional)]

Operating temperature:

0 °C to 35 °C

Operating humidity:

10%RH to 80%RH

Battery operation time:

See page 24

HM-TA20

Waterproof performance:

Equivalent to IEC 60529 "IPX8".

(Usable for 60 minutes in 3 m water depth)

HM-TA20

Dustproof performance:

Equivalent to IEC 60529 "IP5X".

HM-TA20

Crash resistance performance:

The test method of the unit is in compliance with "MIL-STD 810F Method 516.5-Shock".*

* "MIL-STD 810F Method 516.5-Shock" is the test method standard of the U.S. Defense Department, which specifies performing drop tests from a height of 122 cm, at 26 orientations (8 corners, 12 ridges, 6 faces) using 5 sets of devices, and passing the 26 orientation drops within 5 devices.

(If failure occurs during the test, a new set is used to pass the drop orientation test within a total of 5 devices.)

- Panasonic's test method is based on the above "MIL-STD 810F Method 516.5-Shock". However, the drop height was changed from 122 cm to 150 cm dropping onto 3 cm thick plyboard. This drop test was passed.

(Disregarding appearance change such as loss of paint or distortion of the part where drop impact is applied.)

There is no guarantee of not breaking or malfunctioning under all conditions.

■ Motion pictures

Recording media:

SD Memory Card (FAT12 and FAT16 system compliant)

SDHC Memory Card (FAT32 system compliant)

SDXC Memory Card (exFAT system compliant)

Refer to page 26 for details on SD cards usable in this unit.

Built-in memory; Approx. 10 MB

Compression:

MPEG-4 AVC/H.264, iFrame

Recording mode and transfer rate:

 ; Approx. 12 Mbps (VBR)

 ; Approx. 9 Mbps (VBR)

 ; Approx. 3 Mbps (VBR)

 ; Approx. 24 Mbps (VBR)

Refer to page 92 for the recordable time.

Picture size:

 ; 1920×1080/30p

 ; 1280×720/30p

 ; 640×480/30p

 ; 960×540/30p

Audio compression:

AAC (2 ch)

■ Still pictures

Recording media:

SD Memory Card (FAT12 and FAT16 system compliant)

SDHC Memory Card (FAT32 system compliant)

SDXC Memory Card (exFAT system compliant)

Refer to page 26 for details on SD cards usable in this unit.

Built-in memory; Approx. 10 MB

Compression:

JPEG (Design rule for Camera File system, based on Exif 2.2 standard)

Picture size:

Picture aspect [4:3];

3264×2448/1600×1200/640×480

Picture aspect [16:9];

1920×1080

Refer to page 93 for the number of recordable pictures.

■ Voices

Recording media:

SD Memory Card (FAT12 and FAT16 system compliant)

SDHC Memory Card (FAT32 system compliant)

SDXC Memory Card (exFAT system compliant)

Refer to page 26 for details on SD cards usable in this unit.

Built-in memory; Approx. 10 MB

Compression:

AAC

Specifications may change without prior notice.

Index

■ A

- Alert sound 57
- Approximate number of recordable pictures 93

■ B

- Battery 86
- Battery capacity indication 25

■ C

- Card 26, 86
- Charging time 24, 25
- Cleaning 85
- Condensation 87
- Creating still picture from motion picture 51

■ D

- Date and time setting 32
- Date format 56
- Delete 49
- Delete unwanted parts 52
- Digital zoom 39

■ E

- Effect function 40

■ F

- Formatting 58

■ H

- HD Writer PE 2.0 61
- HDMI output 57
- HDMI resolution 57

■ I

- Intelligent auto mode 38

■ L

- Language 58
- LCD monitor 85
- LED light 39
- Lens 86

■ M

- Motion picture compatibility ... 46

■ N

- Night view mode 40

■ P

- Picture size 55
- Playback zoom 48
- Power button 30

■ R

- Recordable time (motion pictures) 24, 92
- Recordable time (voices) 25, 93
- Remaining number of recordable pictures 36
- Remaining time for motion picture recording 35
- Remaining time for voice recording 37
- Reset button 82

■ S

- Screen lock button 41
- SD Memory Card 26
- SD Speed Class Rating 26
- SDHC Memory Card 26
- SDXC Memory Card 26
- Self timer 56
- Setup menu 54
- Share setting 53, 61
- Skip playback 43
- Skype 73
- Slide show/
Continuous playback 47
- Still picture compatibility 46
- Stylus pen 31

■ T

- Touch screen 31

■ V

- Video Recording modes 54
- Voice compatibility 46
- Voice Recording modes 55
- Volume adjustment 43

EU



EU

Pursuant to at the directive 2004/108/EC, article 9(2)
Panasonic Testing Centre
Panasonic Marketing Europe GmbH
Winsbergring 15, 22525 Hamburg, Germany

Panasonic Corporation

Web site: <http://panasonic.net>

© Panasonic Corporation 2011

VQT3P01-1

F0411MY1041

1AG6P1P6267-A(S)