

Panasonic[®]

Operating Instructions for advanced features

Digital Camera

Model No. **DMC-FT25**

LUMIX

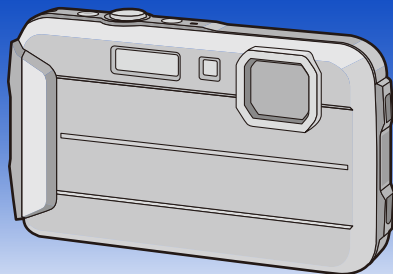

Please read these instructions carefully before using this product,
and save this manual for future use.



VQT4N80
F112YS0

Contents

Before Use

Care of the camera	6
(Important) About the Waterproof/Dustproof and Anti-shock Performance of the Camera	8
Standard Accessories	13
Names and Functions of Main Parts	14

Preparation

Charging the Battery	16
• Charging	16
• Approximate operating time and number of recordable pictures	18
Inserting and Removing the Card (optional)/ the Battery	20
About the Built-in Memory/the Card	22
• Approximate number of recordable pictures and available recording time	24
Setting Date/Time (Clock Set)	25
• Changing the Clock Setting	26
Tips for taking good pictures	27
• Fit the strap and hold the camera carefully	27
• Preventing jitter (camera shake)	27

Basic

Selecting the Recording Mode	28
Taking pictures using the automatic function (Intelligent Auto Mode)	29
• Changing the settings	31
Taking pictures with your favourite settings (Normal Picture Mode)	32
Focusing	33
Recording Motion Pictures	35
Playing Back	37
• Displaying Multiple Screens (Multi Playback)	38
• Using the Playback Zoom	38
Deleting Pictures	39
• To delete a single picture	39
• To delete multiple pictures (up to 100) or all the pictures	39
Setting the Menu	40
• Setting menu items	40
• Using the Quick Menu	41
About the Setup Menu	42

Recording

About the LCD Monitor	51
Using the Zoom	52
• Optical Zoom	52
• Extra Optical Zoom (EZ)	53
• Intelligent Zoom	53
• Digital Zoom.....	53
Taking Pictures Using the Built-in Flash	54
• Switching to the appropriate flash setting	54
Taking Close-up Pictures ([AF Macro]/[Macro Zoom])	58
Taking Pictures with the Self-timer	59
Compensating the Exposure	60
Taking Pictures Using Auto Bracket	61
Taking Pictures with different image effects (Creative Control Mode)	62
• [Expressive]	63
• [Retro]	63
• [High Key]	63
• [Low Key]	63
• [Sepia].....	64
• [Dynamic Monochrome].....	64
• [Impressive Art].....	64
• [High Dynamic]	64
• [Cross Process]	65
• [Toy Effect].....	65
• [Miniature Effect].....	66
• [One Point Color]	66
Take the Outdoors Scene Expressively	67
• [Sports].....	67
• [Snow].....	67
• [Beach & Surf].....	67
• [Advanced Underwater]	68
Taking panorama pictures ([Panorama Shot])	69
Taking pictures that match the scene being recorded (Scene Mode)	72
• [Portrait]	73
• [Soft Skin]	73
• [Scenery].....	73
• [Night Portrait].....	74
• [Night Scenery]	74
• [Food].....	74
• [Baby1]/[Baby2]	75
• [Pet]	76
• [Sunset].....	76
• [High Sens.]	76
• [Starry Sky]	76
• [Glass Through]	76

Entering Text	77
Using the [Rec] Menu	78
• [Picture Size].....	78
• [Sensitivity].....	79
• [White Balance].....	80
• [AF Mode].....	82
• [Face Recog.].....	85
• [i.Exposure].....	89
• [i.Resolution].....	89
• [Digital Zoom].....	89
• [Burst].....	90
• [Time Lapse Shot].....	92
• [Color Mode].....	95
• [Color Reproduction].....	95
• [AF Assist Lamp].....	95
• [Red-Eye Removal].....	96
• [Stabilizer].....	96
• [Date Stamp].....	97
• [Clock Set].....	97
Using the [Motion Picture] Menu	98
• [Rec Quality].....	98
• [Continuous AF].....	98

Playback/Editing

Various methods of playback	99
• [Slide Show].....	99
• [Filtering Play].....	101
• [Calendar].....	104
Having Fun with Recorded Pictures (Retouch)	105
• [Auto Retouch].....	105
• [Creative Retouch].....	106
• [Color Reproduction].....	107
Using the [Playback] Menu	108
• [Text Stamp].....	108
• [Retouch].....	110
• [Video Divide].....	110
• [Time Lapse Video].....	111
• [Resize].....	112
• [Cropping].....	113
• [Favorite].....	114
• [Print Set].....	115
• [Protect].....	117
• [Face Rec Edit].....	118
• [Copy].....	119

Connecting to other equipment

Playing Back Pictures on a TV Screen	120
Saving still pictures and motion pictures on your PC	122
• About the supplied software	122
Saving still pictures and motion pictures on a Recorder	126
• Copy by inserting the SD card into the recorder.....	126
Printing the Pictures	127
• Selecting a single picture and printing it	128
• Selecting multiple pictures and printing them	128
• Print Settings	129

Others

Screen Display	132
Cautions for Use	134
Message Display	142
Troubleshooting	145

Please be sure to read “(Important) About the Waterproof/Dustproof and Anti-shock Performance of the Camera” (P8) before using this unit underwater to prevent the unit from being mishandled, which may cause water to seep in.

Care of the camera

■ Handling of the camera (to prevent water leakage and malfunction)

- Foreign objects may adhere to the inner side of the side door (around the rubber seal or connecting terminals) when the side door is opened or closed in places with sand or dust etc. This may result in the impairment of the waterproof performance if the side door is closed with foreign objects adhered. Be extremely careful since it may result in malfunction etc.
- In case foreign objects adhere to the inner side of the side door, wipe them off with a dry, lint-free cloth.
- If any liquid such as water droplets is adhered to the camera or inner side of the side door, wipe off with a soft dry cloth. Do not open or close the side door near the water, when underwater, using wet hands, or when the camera is wet. It may cause water leakage.

Do not apply strong shock or vibration by dropping or knocking the camera. Also, do not apply strong pressure to the camera.

e.g.:

- Sit down with the camera in your trousers pocket or forcefully insert it into a full or tight bag, etc.
- Attach any items such as accessories to the strap attached to the camera.
- When strong pressure is applied using the camera at a depth exceeding 7 m (23 feet).
- Waterproof performance may be impaired.
- **Lens or LCD monitor may be damaged.**
- It may cause malfunction in the performance or the function.



■ When inner side of the lens is fogged (condensation)

It is not a malfunction or failure of the camera. It may be caused by the environment in which the camera is used.

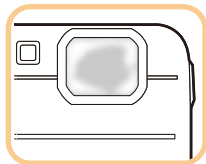
**What to do when inner side of the lens is fogged**

- Turn this unit off and open the side door in a place with constant ambient temperature, away from high temperatures, humidity, sand and dust. The fog will disappear naturally in 10 minutes to 2 hours with the side door open when the temperature of the camera gets close to the ambient temperature.
- Contact Panasonic if the fogging does not disappear.

Conditions in which inner side of the lens may be fogged

Condensation may occur and the inner side of the lens may be fogged when the camera is used in areas that undergo a significant change in temperature or in high humidity, such as the following:

- When the camera is used underwater suddenly after being on a hot beach etc.
- When the camera is moved to a warm area from a cold area, such as at a ski resort or at high altitude
- When the side door is opened in a high-humidity environment

(Important) About the Waterproof/Dustproof and Anti-shock Performance of the Camera

Waterproof/Dustproof Performance

This camera's waterproof/dustproof rating complies with the "IPX8" and "IP6X" ratings. Provided the care and maintenance guidelines described in this document are strictly followed, this camera can operate underwater, to a depth not exceeding 7 m (23 feet) for a time not exceeding 60 minutes. (*1)

Anti-shock Performance

This camera also complies with "MIL-STD 810F Method 516.5-Shock". The camera has cleared a drop test from a height of 1.5 m (5 feet) onto 3 cm (0.1 feet) thick plywood. In most cases this camera should not sustain any damage if dropped from a height not exceeding 1.5 m (5 feet). (*2)

This does not guarantee no destruction, no malfunction, or waterproofing in all conditions.

- *1 This means that the camera can be used underwater for specified time in specified pressure in accordance with the handling method established by Panasonic.
- *2 "MIL-STD 810F Method 516.5-Shock" is the test method standard of the U.S. Defense Department, which specifies performing drop tests from a height of 122 cm (4 feet), at 26 orientations (8 corners, 12 ridges, 6 faces) using 5 sets of devices, and passing the 26 orientation drops within 5 devices. (If failure occurs during the test, a new set is used to pass the drop orientation test within a total of 5 devices)
Panasonic's test method is based on the above "MIL-STD 810F Method 516.5-Shock". However, the drop height was changed from 122 cm (4 feet) to 150 cm (5 feet) dropping onto 3 cm (0.1 feet) thick plywood. This drop test was passed.
(Disregarding appearance change such as loss of paint or distortion of the part where drop impact is applied.)

■ Handling of the camera

- Waterproofing is not guaranteed if the unit is subject to an impact as a result of being hit or dropped etc. If an impact to the camera occurs, it should be inspected (subject to a fee) by Panasonic to verify that the waterproofing is still effective.
- When the camera is splashed with detergent, soap, hot spring, bath additive, sun oil, sun screen, chemical, etc., wipe it off immediately.
- Waterproof function of the camera is for sea water and fresh water only.
- Any malfunction caused by customer misuse, or mishandling will not be covered by the warranty.
- The inside of this unit is not waterproof. Water leakage will cause malfunction.
- Supplied accessories are not waterproof.
- Card and battery are not waterproof. Do not handle with a wet hand. Also, do not insert wet card or battery into the camera.
- Do not leave the camera for a long period of time in places where the temperature is very low (such as at ski resorts or high altitudes) or where the temperature may exceed 40 °C (104 °F) (such as inside cars in strong sunlight, close to a heater, on boats, or on the beach). (Waterproof performance may become degraded.)

■ About the [Precautions] demonstration display ([Requirements for Underwater use])

- [Precautions] is displayed when this unit is turned on for the first time after purchase, with the side door completely closed.
- Please check beforehand to maintain the waterproof performance.

1 Press ◀ to select [Yes], and press [MENU/SET].

- It will automatically skip to the clock setting screen if [No] is selected before it starts.

2 Press ◀/▶ to select the picture.

◀: Return to the previous screen

▶: View the next screen

- It can be forcefully ended by pressing [MENU/SET].
- When it is forcefully ended while checking by turning the unit off or pressing [MENU/SET], [Precautions] is displayed every time this unit is turned on.

3 After the final screen (12/12), press [MENU/SET] to finish.

- When [MENU/SET] is pressed after the final screen (12/12), [Precautions] is not displayed from the next time this unit is turned on.
- This can also be viewed from [Precautions] (P42) in the [Setup] menu.

Check before using underwater

Always wipe the rubber seal on the side door and the area where rubber seal sits with a dry, lint-free cloth.

- 1 Check that there are no foreign objects on the inner side of the side door.**
 - If there is any foreign object, such as lint, hair, sand, etc., on the surrounding area, water will leak within a few seconds causing malfunction.
 - Wipe it off with a dry soft cloth if there is any liquid.
 - It may cause water leaks and malfunction if you use the camera with liquid adhered.
 - If foreign objects are present, wipe them off with a dry, lint-free cloth.
 - Be extremely careful to remove the small sand etc. that may adhere to the sides and corners of the rubber seal.
- 2 Check for cracks and deformation of the rubber seal on the side door.**
 - The integrity of the rubber seals may decrease after about 1 year, with use and age. To avoid permanently damaging the camera the seals should be replaced once each year. Please contact Panasonic for related costs and other information.

- 3 Close the side door securely.**

(A) [LOCK] switch (grey part)

(B) Red part

(C) Released state

(D) Locked state

- Lock the [LOCK] switch securely until the red part is no longer visible.
- To prevent water intrusion, be careful not to catch foreign objects such as liquids, sand, hair, dust, or the strap cord.

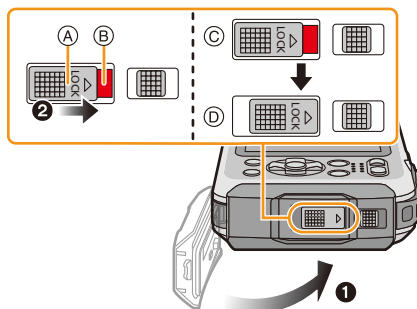

Do not open or close the side door in places with sand and dust, close to water, or with wet hands. Sand or dust adhering may cause water leaks.

Using the camera underwater

- Use the camera underwater to 7 m (23 feet) with the water temperature between 0 °C and 40 °C (32 °F and 104 °F).
- Do not use for scuba diving (Aqualung).
- Do not use the camera at a depth of over 7 m (23 feet).
- Do not use it in the hot water over 40 °C (104 °F) (in the bath or hot spring).
- Do not use the camera underwater for longer than 60 minutes continuously.
- Do not open or close the side door underwater.
- Do not apply shock to the camera underwater. (Waterproof performance may not be maintained, and there is a chance of water leak.)
- Do not dive into the water holding the camera. Do not use the camera in a location where the water will splash strongly, such as rapid flow or waterfall. (Strong water pressure may be applied, and it may cause malfunction.)
- The camera will sink in the water. Take care not to drop the camera and lose it underwater by securely placing the strap around your wrist or similar measure.

Caring of the camera after using it underwater

Do not open or close the side door until the sand and dust is removed by rinsing the camera with water.

Make sure to clean the camera after using it.

- Thoroughly wipe off any water droplets, sand, and saline matter on your hands, body, hair, etc.
- It is recommended to clean the camera indoors, avoiding places where water spray or sand may fall.

After using it underwater, always clean the camera rather than leaving it in a dirty state.

- Leaving the camera with foreign objects or saline matter on it may cause damage, discolouration, corrosion, unusual odour, or deterioration of the waterproof performance.

1 Rinse with water with the side door closed.

- After use at the seaside or underwater, soak the unit in fresh water pooled in a shallow container for 10 minutes or less.
- If the zoom button or camera [ON/OFF] button do not press smoothly, it may be caused by an adhesion of foreign objects. Using in such a state may cause malfunctions, such as locking up, so wash off any foreign objects by shaking the camera in fresh water.
- Bubbles may come out of the drainage hole when you immerse the camera in water, but this is not a malfunction.



2 Drain water by holding the camera upside-down (A) and the right way up (B) and shaking it lightly a few times.

- After using the camera at the beach or in water, or after washing it, water may remain around the speaker and microphone for a while and may cause a drop in volume or sound distortion.
- Make sure to put your hand through the strap to prevent the camera from falling.

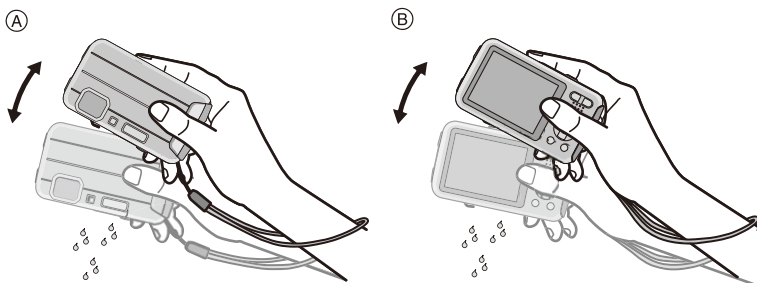

3 Wipe off water drops on the camera with a dry soft cloth and dry the camera in a shaded area which is well ventilated.

- Dry the camera by standing it on a dry cloth. This unit incorporates drain design, draining water in gaps in the camera [ON/OFF] button and zoom button etc.
- Do not dry the camera with hot air from dryer or similar. Waterproof performance will deteriorate due to deformation.
- Do not use chemicals such as benzine, thinner, alcohol or cleanser, soap or detergents.



4 Confirm that there are no water droplets, open the side door, and wipe off any water droplets or sand left inside using a soft dry cloth. (P137)

- Water droplets may adhere to the card or battery when the side door is opened without thoroughly drying. Also, water may accumulate in the gap around the card/battery slot or the terminal connector. Be sure to wipe any water off with a soft dry cloth.
- The water droplets may seep into the camera when the side door is closed while it is still wet, causing condensation or failure.

Standard Accessories

Check that all the accessories are supplied before using the camera.

- Supplied accessories are not waterproof.
- The accessories and their shape will differ depending on the country or area where the camera was purchased.
For details on the accessories, refer to “Basic Operating Instructions”.
- Battery Pack is indicated as **battery pack** or **battery** in the text.
- Battery Charger is indicated as **battery charger** or **charger** in the text.
- SD Memory Card, SDHC Memory Card and SDXC Memory Card are indicated as **card** in the text.
- **The card is optional.**
You can record or play back pictures on the built-in memory when you are not using a card.
- Consult the dealer or Panasonic if you lose the supplied accessories. (You can purchase the accessories separately.)

Names and Functions of Main Parts

- 1 Flash (P54)
- 2 Motion picture button (P35)
- 3 Shutter button (P29, 32)
- 4 Camera [ON/OFF] button (P25)
- 5 Microphone
- 6 Self-timer indicator (P59)/
AF Assist Lamp (P95)/
LED light (P47)
- 7 Lens (P7, 138, 148)

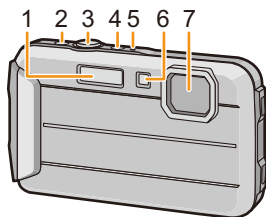

- 8 LCD monitor (P51, 132, 137)
 - 9 [MODE] button (P28, 99)
 - 10 Zoom button (P52)
 - 11 Strap eyelet (P27)
- Be sure to attach the strap when using the camera to ensure that you will not drop it.

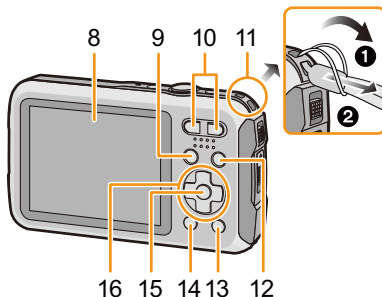

- 12 [▶] (Playback) button (P37)
- 13 [Q.MENU] button (P41)/
[🗑️/↩️] (Delete/Cancel) button (P39)
- 14 [DISP.] button (P51)
- 15 [MENU/SET] button (P40)

16 Cursor buttons

- (A): ▲/Exposure compensation (P60)
Auto Bracket (P61)
- (B): ▼/Macro Mode (P58)
AF Tracking (P84)
- (C): ◀/Self-timer (P59)
- (D): ▶/Flash setting (P54)

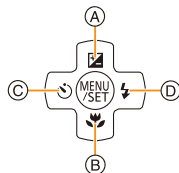

In these operating instructions, the cursor buttons are described as shown in the figure below or described with ▲/▼/◀/▶.

e.g.: When you press the ▼ (down) button



or **Press ▼**

17 Speaker (P44)

- Be careful not to cover the speaker with your finger. Doing so may make sound difficult to hear.

18 Tripod mount

- A tripod with a screw length of 5.5 mm (0.22 inch) or more may damage this unit if attached.

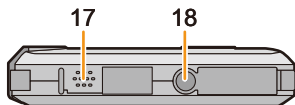
**19 [AV OUT/DIGITAL] socket (P120, 124, 126, 127)****20 Card slot (P20)****21 Battery slot (P20)**

- When using an AC adaptor, ensure that the Panasonic DC coupler (optional) and AC adaptor (optional) are used. For connection details, refer to P21.

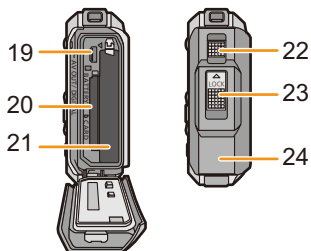
22 Release lever (P20)**23 [LOCK] switch (P10, 20)****24 Side door (P10, 20)**

Charging the Battery

About batteries that you can use with this unit

It has been found that counterfeit battery packs which look very similar to the genuine product are made available for purchase in some markets. Some of these battery packs are not adequately protected with internal protection to meet the requirements of appropriate safety standards. There is a possibility that these battery packs may lead to fire or explosion. Please be advised that we are not liable for any accident or failure occurring as a result of use of a counterfeit battery pack. To ensure that safe products are used. We recommend that a genuine Panasonic battery pack is used.

- Use the dedicated charger and battery.

Charging

- The battery is not charged when the camera is shipped. Charge the battery before use.
- Charge the battery with the charger indoors.
- Charge the battery in areas with an ambient temperature, between 10 °C and 30 °C (50 °F and 86 °F) (same as the battery temperature), is recommended.

- 1 Attach the battery paying attention to the direction of the battery.

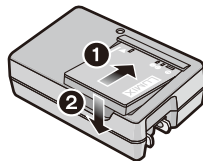

- 2 Connect the charger to the electrical outlet.

- The [CHARGE] indicator (A) lights up and charging begins.

plug-in type

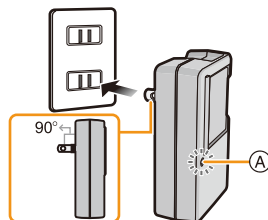

inlet type

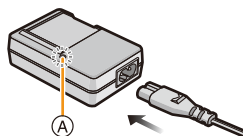

■ About the [CHARGE] indicator

On: Charging.

Off: Charging has completed. (Disconnect the charger from the electrical socket and detach the battery after charging is completed.)

• When the [CHARGE] indicator flashes

- The battery temperature is too high or too low. It is recommended to charge the battery again in an ambient temperature of between 10 °C and 30 °C (50 °F and 86 °F).
- The terminals of the charger or the battery are dirty. In this case, wipe off the dirt with a dry cloth.

■ Charging time

Charging time	Approx. 120 min
----------------------	------------------------

- The indicated charging time is for when the battery has been discharged completely. The charging time may vary depending on how the battery has been used. The charging time for the battery in hot/cold environments or a battery that has not been used for a long time may be longer than normal.

■ Battery indication

The battery indication is displayed on the LCD monitor.



- The indication turns red and blinks if the remaining battery power is low. Recharge the battery or replace it with a fully charged battery.

Do not leave any metal items (such as clips) near the contact areas of the power plug. Otherwise, a fire and/or electric shocks may be caused by short-circuiting or the resulting heat generated.

- The battery becomes warm after using it and during and after charging. The camera also becomes warm during use. This is not a malfunction.
- The battery can be recharged even when it still has some power left, but it is not recommended that the battery charge be frequently topped up while the battery is fully charged. (Since characteristic swelling may occur.)

Approximate operating time and number of recordable pictures

Recording still pictures

Number of recordable pictures	Approx. 250 pictures	By CIPA standard in Normal Picture Mode
Recording time	Approx. 125 min	

Recording conditions by CIPA standard

- CIPA is an abbreviation of [Camera & Imaging Products Association].
- Temperature: 23 °C (73.4 °F)/Humidity: 50%RH when LCD monitor is on.
- Using a Panasonic SD Memory Card (32 MB).
- Using the supplied battery.
- Starting recording 30 seconds after the camera is turned on. (When the Optical Image Stabiliser function is set to [ON].)
- **Recording once every 30 seconds** using full flash every second recording.
- Changing the zoom magnification from Tele to Wide or vice versa in every recording.
- Turning the camera off every 10 recordings and leaving it until the temperature of the battery decreases.

The number of recordable pictures varies depending on the recording interval time. As the recording interval time becomes longer, the number of recordable pictures decreases. [For example, if you were to take one picture every two minutes, then the number of pictures would be reduced to approximately one-quarter of the number of pictures given above (based upon one picture taken every 30 seconds).]

Recording motion pictures

When recording with picture quality set to [HD]

Recordable time	Approx. 100 min
Actual recordable time	Approx. 50 min

- These times are for an ambient temperature of 23 °C (73.4 °F) and a humidity of 50%RH. Please be aware that these times are approximate.
- Actual recordable time is the time available for recording when repeating actions such as turning this unit on and off, starting/stopping recording, zoom operation, etc.
- Maximum time to record motion pictures continuously is 29 minutes 59 seconds. The maximum available recording time continuously is displayed on the screen.

■ Playback

Playback time

Approx. 240 min

- **The operating times and number of recordable pictures will differ according to the environment and the operating conditions.**

For example, in the following cases, the operating times will shorten and the number of recordable pictures is reduced:

– At low temperature or in cold locations such as ski resorts or at high altitude*

* **Residual image may show on the LCD display when in use. The battery performance will decrease, so keep the camera and spare batteries warm by placing them in a warm place such as inside your cold protection gear or clothing. Performance of batteries and LCD monitor will restore to normal when the temperature returns to normal.**

– When using [Monitor Luminance].

– When operations such as flash and zoom are used repeatedly.

- When the operating time of the camera becomes extremely short even after properly charging the battery, the life of the battery may have expired. Buy a new battery.

Inserting and Removing the Card (optional)/ the Battery

- Check that this unit is turned off.
- **Confirm that there is no foreign object. (P10)**
- We recommend using a Panasonic card.

1 **1:** Slide the [LOCK] switch (A), and release the lock.

2: Slide the release lever (B) and open the side door.

- Always use genuine Panasonic batteries.
- If you use other batteries, we cannot guarantee the quality of this product.

2 **Battery:** Being careful about the battery orientation, insert all the way until you hear a locking sound and then check that it is locked by lever (C). Pull the lever (C) in the direction of the arrow to remove the battery.

Card: Push it securely all the way until you hear a “click” while being careful about the direction in which you insert it. To remove the card, push the card until it clicks, then pull the card out upright.

ⓓ: Do not touch the connection terminals of the card.

3 Close the side door until it clicks, and then lock the [LOCK] switch by sliding it toward [◀].

- Confirm that the red part on the [LOCK] switch is not showing.

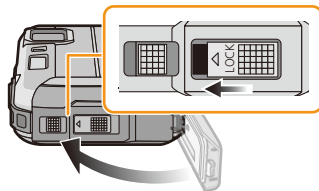
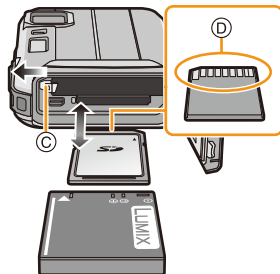
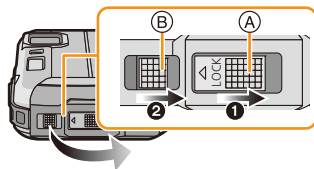

- Remove the battery after use. (The battery will be exhausted if left for a long period of time after being charged.)
- Turn the camera off and wait for the “LUMIX” display on the LCD monitor to clear before removing the card or battery. (Otherwise, this unit may no longer operate normally and the card itself may be damaged or the recorded pictures may be lost.)

■ About the water leakage warning message

To maintain the waterproof performance of this unit, a message prompting to check for any foreign material inside the side door or to perform maintenance is displayed along with a warning sound when the following are performed. (P144)

- When this unit is turned on after opening the side door and replacing the card.
 - When this unit is turned on after opening the side door and replacing the battery.
- After opening the side door, close it securely taking care not to get any foreign objects caught.
 - If foreign objects are present, wipe them off with a dry, lint-free cloth.
 - Warning message display can be turned off by pressing any button.

Using an AC adaptor (optional) and a DC coupler (optional) instead of the battery

The AC adaptor (optional) can only be used with the designated Panasonic DC coupler (optional). The AC adaptor (optional) cannot be used by itself.

- 1 Open the side door (A).
 - 2 Insert the DC coupler, being careful of the direction.
 - 3 Plug the AC adaptor into an electrical outlet.
 - 4 Connect the AC adaptor (B) to the [DC IN] socket (C) of the DC coupler.
- Ensure that only the AC adaptor and DC coupler for this camera are used. Using any other equipment may cause damage.

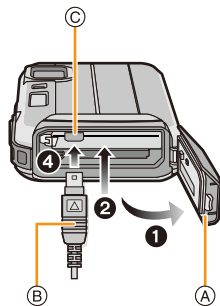

- Always use a genuine Panasonic AC adaptor (optional).
- When using an AC adaptor, use the AC cable supplied with the AC adaptor.
- Side door cannot be closed while the AC adaptor is connected.
- **Do not apply any force to the side door with the weight of the cable or your hand when the AC adaptor is connected. It may cause damage.**
- **The DC coupler may get disconnected from this unit if a cable is pulled when connecting the AC adaptor, so take caution.**
- Before removing the DC coupler, turn the camera off and disconnect the AC adaptor.
- Also read the operating instructions for the AC adaptor and DC coupler.
- Waterproof/dustproof function does not operate when the AC adaptor is connected.

About the Built-in Memory/the Card

The following operations can be performed using this unit:

When a card has not been inserted	Pictures can be recorded on the built-in memory and played back.
When a card has been inserted	Pictures can be recorded on the card and played back.

• When using the built-in memory

 →  (access indication*)

• When using the card

 (access indication*)

- * The access indication is displayed in red when pictures are being recorded on the built-in memory (or the card).



Built-in Memory

- You can copy the recorded pictures to a card. (P119)
- Memory size: Approx. 70 MB**
- The access time for the built-in memory may be longer than the access time for a card.

Card

The following cards, which conform to the SD video standard, can be used with this unit. (These cards are indicated as **card** in the text.)

	Remarks
SD Memory Card (8 MB to 2 GB)	<ul style="list-style-type: none"> • Use a card with SD Speed Class* with “Class 4” or higher when recording motion pictures. • SDHC Memory Cards and SDXC Memory Cards can be used only with their compatible devices. • Check that the PC and other equipment are compatible when using the SDXC Memory Cards. http://panasonic.net/avc/sdcard/information/SDXC.html • Only the cards with capacity listed left can be used.
SDHC Memory Card (4 GB to 32 GB)	
SDXC Memory Card (48 GB, 64 GB)	

- * SD Speed Class is the speed standard regarding continuous writing. Check via the label on the card, etc.

e.g.:

CLASS 



- Please confirm the latest information on the following website.

<http://panasonic.jp/support/global/cs/dsc/>

(This site is English only.)

- Do not turn this unit off, remove its battery or card, or disconnect the AC adaptor (optional) when the access indication is lit (when pictures are being written, read or deleted, or the built-in memory or the card is being formatted). Furthermore, do not subject the camera to vibration, impact or static electricity.

The card or the data on the card may be damaged, and this unit may no longer operate normally.

If operation fails due to vibration, impact or static electricity, perform the operation again.

- Write-Protect switch (A) provided (When this switch is set to the [LOCK] position, no further data writing, deletion or formatting is possible. The ability to write, delete and format data is restored when the switch is returned to its original position.)
- The data on the built-in memory or the card may be damaged or lost due to electromagnetic waves, static electricity or breakdown of the camera or the card. We recommend storing important data on a PC etc.
- Do not format the card on your PC or other equipment. Format it on the camera only to ensure proper operation. (P50)
- Keep the Memory Card out of reach of children to prevent swallowing.

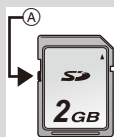

Approximate number of recordable pictures and available recording time

About the display of the number of recordable pictures and available recording time

- Switch the display (number of recordable pictures, available recording time, etc.) by pressing [DISP.]. (P51)

- Ⓐ Number of recordable pictures
- Ⓑ Available recording time



- The number of recordable pictures and the available recording time are an approximation. (These vary depending on the recording conditions and the type of card.)
- The number of recordable pictures and the available recording time varies depending on the subjects.

Number of recordable pictures

- [+99999] is displayed if there are more than 100,000 pictures remaining.

[Picture Size]	Built-in Memory (Approx. 70 MB)	2 GB	32 GB	64 GB
16M (4:3)	14	300	4910	9880
5M (4:3)	32	660	10620	21490
0.3M (4:3)	510	10240	162960	247160

Available recording time (when recording motion pictures)

- “h” is an abbreviation for hour, “m” for minute and “s” for second.

[Rec Quality]	Built-in Memory (Approx. 70 MB)	2 GB	32 GB	64 GB
HD	—	23m45s	6h28m15s	13h5m20s
VGA	2m22s	52m17s	14h14m28s	28h48m24s

- The recordable time is the total time of all the motion pictures which have been recorded.
- Maximum time to record motion pictures continuously is 29 minutes 59 seconds.
- The maximum available continuous recording time is displayed on the screen.

Setting Date/Time (Clock Set)

- The clock is not set when the camera is shipped.

1 Press camera [ON/OFF] button.

- If the language select screen is not displayed, proceed to [Requirements for Underwater use] below.

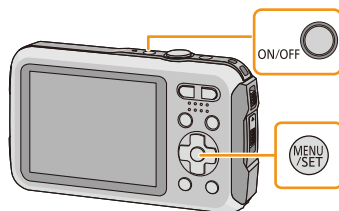

2 Press [MENU/SET].

3 Press ▲/▼ to select the language, and press [MENU/SET].

[Requirements for Underwater use]

Be sure to check this so that you can maintain the waterproof performance.

[Please set the clock] is displayed after viewing the last screen.

For details, refer to [P9](#).

4 Press [MENU/SET].



- 5** Press ◀/▶ to select the items (year, month, day, hour, minute, display sequence or time display format), and press ▲/▼ to set.

(A): Time at the home area

(B): Time at the travel destination

- You can cancel without setting the clock by pressing [⏏/↵].

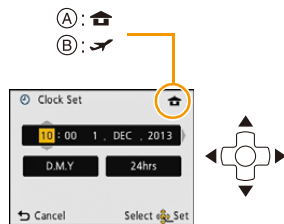

- 6** Press [MENU/SET] to set.

- 7** Press [MENU/SET].

Changing the Clock Setting

Select [Clock Set] in the [Rec] or [Setup] menu, and press [MENU/SET]. (P40)

- The clock can be reset as shown in steps **5** and **6**.
- The clock setting is maintained for 3 months using the built-in clock battery even without the battery. (Leave the charged battery in the unit for 24 hours to charge the built-in battery.)**
- If the clock is not set, the correct date cannot be printed when you order a photo studio to print the picture, or when you stamp the date on the pictures with [Date Stamp] or [Text Stamp].
- If the clock is set, the correct date can be printed even if the date is not displayed on the screen of the camera.

Tips for taking good pictures

Fit the strap and hold the camera carefully

Hold the camera gently with both hands, keep your arms still at your side and stand with your feet slightly apart.

- To prevent dropping, be sure to attach the supplied strap and fit it to your wrist. (P14)
- Do not swing around or pull forcefully on the unit with the strap attached. The strap may break.
- Be careful not to move the camera when you press the shutter button.
- Be careful not to put your fingers on the flash, AF assist lamp/LED light, microphone, speaker or lens etc.

- (A) Strap
- (B) Speaker
- (C) Flash
- (D) Microphone
- (E) AF Assist Lamp/LED light

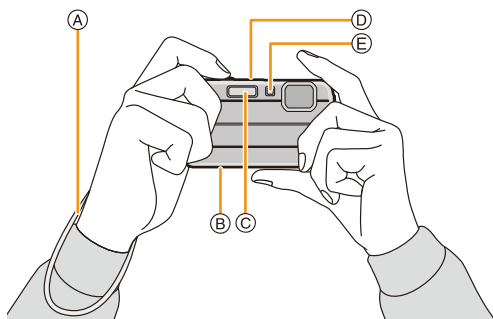

Direction Detection Function ([Rotate Disp.])

Pictures recorded with the camera held vertically are played back vertically (rotated). (Only when [Rotate Disp.] (P49) is set)

- When the camera is held vertically and tilted up and down to record pictures, the Direction Detection function may not work correctly.
- Motion pictures taken with the camera held vertically are not displayed vertically.

Preventing jitter (camera shake)

When the Jitter alert [] appears, use [Stabilizer] (P96), a tripod or the Self-timer (P59).

- Shutter speed will be slower particularly in the following cases. Keep the camera still from the moment the shutter button is pressed until the picture appears on the screen. We recommend using a tripod.
 - Slow sync./Red-Eye Reduction
 - [Night Portrait]/[Night Scenery]/[Starry Sky](Scene Mode)

Selecting the Recording Mode

1 Press [MODE].

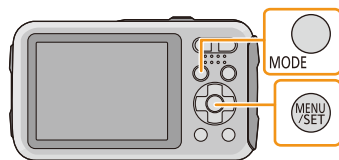









2 Press ▲/▼/◀/▶ to select the Recording Mode.



3 Press [MENU/SET].

List of Recording Modes

 Intelligent Auto Mode (P29)
The subjects are recorded using settings automatically selected by the camera.
 Normal Picture Mode (P32)
The subjects are recorded using your own settings.
 Creative Control Mode (P62)
Record while checking the image effect.
 Sports Mode (P67)
Use this mode to take pictures of sporting events, etc.
 Snow Mode (P67)
This allows you to take pictures that show the snow as white as possible at a ski resort or a snow-covered mountain.

 Beach & Surf Mode (P67)
This mode is optimal for taking pictures to 3 m (10 feet) underwater and at the beach.
 Advanced Underwater Mode (P68)
This mode is optimal for taking pictures at depths of 3 m (10 feet) to 7 m (23 feet).
 Panorama Shot Mode (P69)
This mode allows you to take panorama pictures.
 Scene Mode (P72)
This allows you to take pictures that match the scene being recorded.

- When the mode has been switched from Playback Mode to Recording Mode, the previously set Recording Mode will be set.

Taking pictures using the automatic function

(Intelligent Auto Mode)

Recording Mode:

The camera will set the most appropriate settings to match the subject and the recording conditions so we recommend this mode for beginners or those who want to leave the settings to the camera and take pictures easily.

• The following functions are activated automatically.

- Scene Detection/Backlight Compensation/Intelligent ISO sensitivity control/Auto White Balance/Face Detection/[i.Exposure]/[i.Resolution]/[i.ZOOM]/[AF Assist Lamp]/[Red-Eye Removal]/[Stabilizer]/[Continuous AF]

1 Press [MODE].

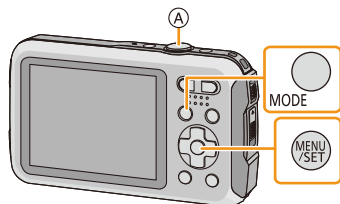

- (A) Shutter button



2 Press /// to select [Intelligent Auto], and then press [MENU/SET].



3 Press the shutter button halfway to focus.

- The focus indication (B) (green) lights when the subject is focused.
- The AF area (C) is displayed around the subject's face by the Face Detection function. In other cases, it is displayed at the point on the subject which is in focus.
- The minimal distance (how close you can be to the subject) will change depending on the zoom factor. Please check with the recordable range display on the screen. (P33)
- If you press  while [AF Tracking] is displayed, you can set AF tracking. For details, refer to P84. (AF tracking is cancelled by pressing  again)

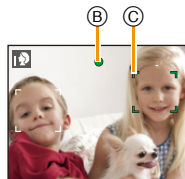







4 Press the shutter button fully (push it in further), and take the picture.



Scene Detection

When the camera identifies the optimum scene, the icon of the scene concerned is displayed in blue for 2 seconds, after which its colour changes to the usual red.





When taking pictures







iA →	 [i-Portrait]	 [i-Scenery]
	 [i-Macro]	 [i-Night Portrait] ^{*1}
	 [i-Night Scenery]	 [i-Sunset]
	 [i-Baby] ^{*2}	

*1 Only when [iA] is selected.

*2 When [Face Recog.] is set to [ON],  will be displayed for birthdays of registered faces already set only when the face of a person 3 years old or younger is detected.

When recording motion pictures

iA →	 [i-Portrait]	 [i-Scenery]
	 [i-Low Light]	 [i-Macro]

- [iA] is set if none of the scenes are applicable, and the standard settings are set.
- When ,  or  is selected, the camera automatically detects a person's face, and it will adjust the focus and exposure. (**Face Detection**)
- If a tripod is used, for instance, and the camera has judged that camera shake is minimal when the Scene Mode has been identified as , the shutter speed will be set to a maximum of 8 seconds. Take care not to move the camera while taking pictures.
- When [Face Recog.] is set to [ON], and the face similar to the registered face is detected, [R] is displayed in the top right of ,  and .
- Due to conditions such as the ones below, a different scene may be identified for the same subject.
 - Subject conditions: When the face is bright or dark, the size of the subject, the colour of the subject, the distance to the subject, the contrast of the subject, when the subject is moving
 - Recording conditions: Sunset, sunrise, under low brightness conditions, underwater, when the camera is shaken, when zoom is used
- For the best results, it is recommended that you take pictures in the appropriate Recording Mode.
- Face Detection may become slower or it may not detect underwater.

The Backlight Compensation

When there is a backlight, the subject appears darker and the camera will automatically attempt to correct it by increasing the brightness of the picture.

In Intelligent Auto Mode, backlight compensation works automatically. The  is displayed on the screen when backlighting is detected. (Depending on the backlighting conditions, backlighting may not be detected correctly.)

Changing the settings

Following menus can be set.

Menu	Item
[Rec]	[Picture Size]*/[Burst]*/[Time Lapse Shot]/[Color Mode]*/[Face Recog.]
[Motion Picture]	[Rec Quality]
[Setup]	[Clock Set]/[World Time]/[Beep]*/[LED Light]/[Language]/ [Stabilizer Demo.] • Menu items other than those listed above are not displayed, but you can set them in other Recording Modes.

- For the setting method of the menu, refer to [P40](#).
- * Settings may be different from other Recording Modes.

[Color Mode]

- Colour setting of [Happy] is available in [Color Mode]. It is possible to automatically take a picture with a higher level of brilliance for the colour brightness and vividness.

About the flash (P54)

- When [~~i~~A] is selected, [~~i~~A], [~~i~~A[Ⓜ]], [~~i~~S[Ⓜ]] or [~~i~~S] is set depending on the type of subject and brightness.
- When [~~i~~A[Ⓜ]], [~~i~~S[Ⓜ]] is set, Red-Eye Removal is enabled.
- Shutter speed will be slower during [~~i~~S[Ⓜ]] or [~~i~~S].

Taking pictures with your favourite settings

(Normal Picture Mode)

Recording Mode:

The camera automatically sets the shutter speed and the aperture value according to the brightness of the subject.

You can take pictures with greater freedom by changing various settings in the [Rec] menu.

1 Press [MODE].

(A) Shutter button

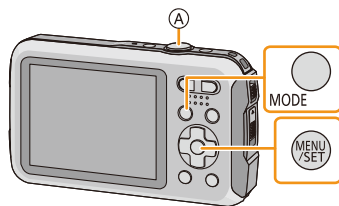

2 Press ▲/▼/◀/▶ to select [Normal Picture], and then press [MENU/SET].



3 Aim the AF area at the point you want to focus on.

4 Press the shutter button halfway to focus and then press it fully to take the picture.

- (B) ISO sensitivity
- (C) Aperture value
- (D) Shutter speed

- Aperture value and shutter speed is displayed in red when correct exposure is not achieved. (Exclude when using a flash)

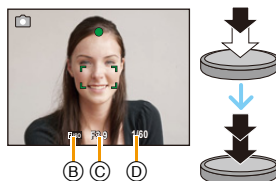

Focusing

Aim the AF area at the subject, and then press the shutter button halfway.

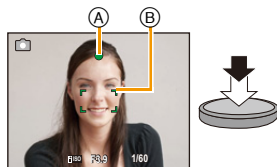

Focus	When the subject is focused	When the subject is not focused
Focus indication (A)	On	Blinks
AF area (B)	White → Green	White → Red
Sound	Beeps 2 times	Beeps 4 times

• The AF area may be displayed larger for certain zoom magnifications and in dark places.

About focus range

The focus range is displayed when operating the zoom.

• The focus range is displayed in red when it is not focused after pressing the shutter button halfway.

The focus range may change gradually depending on the zoom position.



e.g.: Range of focus during the Normal Picture Mode

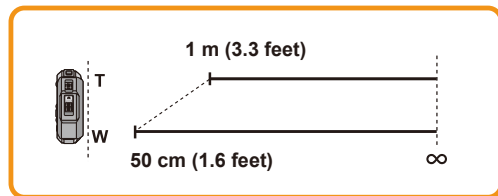

- When the subject is not in focus (such as when it is not in the centre of the composition of the picture you want to take)

- 1 Aim the AF area at the subject, and press the shutter button half way to fix the focus and exposure.
- 2 Press and hold the shutter button half way while moving the camera as you compose the picture.



- You can repeatedly retry the actions in step 1 before pressing the shutter button fully.

■ Subject and recording conditions which are difficult to focus in

- Fast-moving subjects, extremely bright subjects or subjects without contrast
- When recording subjects through windows or near shiny objects
- When it is dark or when jitter occurs
- When the camera is too close to the subject or when taking a picture of both distant and near subjects

Recording Motion Pictures

Applicable modes:          

1 Start recording by pressing the motion picture button.

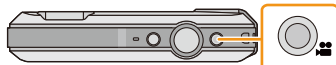

- (A) Available recording time
- (B) Elapsed recording time

- You can record motion pictures fitting each Recording Mode.
- Release the motion picture button right after you press it.
- The recording state indicator (red) (C) will flash while recording motion pictures.
- When recording with [Rec Quality] set to [HD], "Active Mode" (stabiliser for motion pictures) will work automatically. For more details, refer to [Stabilizer] (P96).
- For the setting of [Rec Quality], refer to P98.

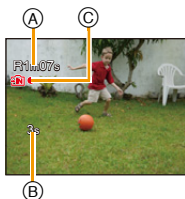

2 Stop the recording by pressing the motion picture button again.

■ About the recording format for recording motion pictures

This unit can record motion pictures in MP4 format.

MP4:

This is a simpler video format best used when extensive editing is needed, or when uploading videos to online services.

■ About the compatibility of the recorded motion pictures

Even if a compatible MP4 playback device is used, the video or sound quality of the recorded motion pictures may be poor, or they may not be able to be played. There may also be times when the recorded data is not displayed properly. If you experience such issues, please play back the video on this camera.

- For details on MP4 compatible devices, refer to the support sites below.

<http://panasonic.jp/support/global/cs/dsc/>

(This Site is English only.)

- When recording to the built-in memory, [Rec Quality] is fixed to [VGA].
- The available recording time displayed on the screen may not decrease regularly.
- Depending on the type of the card, the card access indication may appear for a while after recording motion pictures. This is not a malfunction.
- The screen may be blacked out momentarily, or the unit may record noise due to static electricity or electromagnetic waves etc. depending on the environment of the motion picture recording.
- Even if the aspect ratio setting is the same in still pictures and motion pictures, the angle of view may change at the start of the motion picture recording.
When [Video Rec Area] (P46) is set to [ON], angle of view during motion picture recording is displayed.

• About zooming while recording motion pictures

- If the Extra Optical Zoom are used before pressing the motion picture button, those settings will be cleared, so the shooting range will change dramatically.
- If you operate the zoom etc. while recording motion pictures, the sound of the operation may be recorded.
- The zoom speed will be slower than usual when recording motion pictures.
- Operating the zoom while recording motion pictures can take time for the image to come into focus.
- If you end motion picture recording after a short time when using [Miniature Effect] of the Creative Control Mode, the camera may go on recording for a certain period. Please continue to hold the camera until the recording finishes.
- Noise may be recorded underwater.
- It is recommended to use a fully charged battery or AC adaptor (optional) when recording motion pictures.
- If while recording motion pictures using the AC adaptor (optional) and the power supply is cut off due to a power outage or if the AC adaptor (optional) is disconnected, etc., the motion picture being recorded will not be recorded.
- Motion pictures cannot be recorded in the following case.
 - When using [Time Lapse Shot]
- A sound might be muffled or warped when there is water on the microphone or the speaker. Wipe the residue after letting the water drip out from the microphone and speaker by tipping it down, and use it only after letting it dry for a while. (P138)
- It will be recorded in following categories for certain Recording Modes. A motion picture recording matching each Recording Mode will be performed for the ones not listed below.

Selected Recording Mode	Recording Mode while recording motion picture
• [Baby1]/[Baby2] (Scene Mode)	Portrait Mode
• [Night Portrait]/[Night Scenery]/ [Starry Sky] (Scene Mode)	Low Light Mode
• [Sports] • [Pet] (Scene Mode)	Normal motion picture

Playing Back

1 Press [▶].



2 Press ◀/▶ to select pictures.

- (A) File number
- (B) Picture number

- If you press and hold ◀/▶, you can play back the pictures in succession.
- Speed of picture Forwarding/Rewinding changes depending on the playback status.

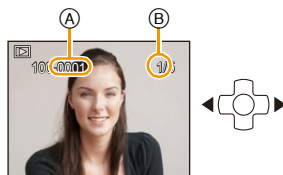

■ Playing Back Motion Pictures

Select a picture with a Motion Picture icon (such as [MP4 (MPEG4)]), and then press ▲ to play back.

- (A) Motion picture icon
- (B) Motion picture recording time

- If you have filtered images for playback by using [Slide Show] (P99) or [Filtering Play] (P101), the selection screen appears. Press ▲/▼ to select [Play Video], and then press [MENU/SET].
- After playback starts, the elapsed playback time is displayed on the screen.

For example, 8 minutes and 30 seconds is displayed as [8m30s].

• Operations performed during Motion Picture Playback

	▲	Play/Pause
	▼	Stop
	◀	Fast rewind* / Frame-by-frame rewind (while pausing)
	▶	Fast forward* / Frame-by-frame forward (while pausing)

* The fast forward/rewind speed increases if you press ▶/◀ again.

– You can adjust the volume with the zoom button.

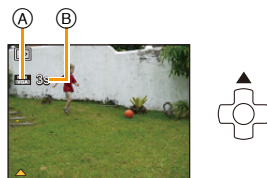

- If you turn on the camera by pressing and holding [RECALL], playback starts automatically.
- This camera complies with the DCF standard “Design rule for Camera File system” established by JEITA “Japan Electronics and Information Technology Industries Association” and with Exif “Exchangeable Image File Format”. Files that do not comply with the DCF standard cannot be played back.
- Images recorded with other camera may not be able to play back on this unit.
- This unit was designed to play motion pictures using the MP4 and QuickTime Motion JPEG formats.
- When using a high capacity card, it is possible that fast rewinding may be slower than usual.
- To play back the motion pictures recorded by this unit on a PC, use the “PHOTOfunSTUDIO” software on the CD-ROM (supplied).
- Be careful not to block the speaker of the camera during playback.

Displaying Multiple Screens (Multi Playback)

Press [W] of the zoom button.

1 screen → 12 screens → 30 screens → Calendar screen display

Ⓐ Number of the selected picture and the total number of recorded pictures

- Press [T] of the zoom button to return to the previous screen.
- Pictures displayed using [RECALL] cannot be played back.



■ To return to normal playback

Press ▲/▼/◀/▶ to select a picture and then press [MENU/SET].

Using the Playback Zoom

Press [T] of the zoom button.

1× → 2× → 4× → 8× → 16×

- When you press [W] of the zoom button after enlarging the picture, the magnification becomes lower.
- When you change the magnification, the zoom position indication Ⓑ appears for about 2 seconds, and the position of the enlarged section can be moved by pressing ▲/▼/◀/▶.
- The more a picture is enlarged, the more its quality deteriorates.

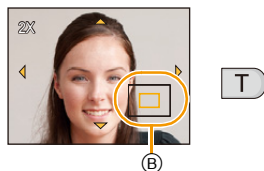

Deleting Pictures

Once deleted, pictures cannot be recovered.

- Pictures on the built-in memory or the card that are being played back will be deleted.
- Pictures that are not in the DCF standard or those that are protected cannot be deleted.

To delete a single picture

Select the picture to be deleted, and then press **[/↵]**.

- Confirmation screen is displayed.
Picture is deleted by selecting [Yes].

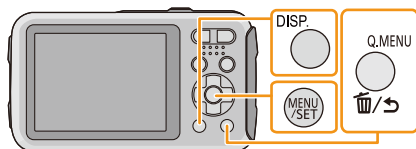

To delete multiple pictures (up to 100) or all the pictures

1 Press **[/↵]**.

2 Press **▲/▼** to select [Delete Multi] or [Delete All] and then press **[MENU/SET]**.



- [Delete All] → Confirmation screen is displayed.
Pictures are deleted by selecting [Yes].
- It is possible to delete all pictures except the ones set as favourite when [All Delete Except Favorite] is selected with the [Delete All] set.

3 (When [Delete Multi] is selected) Press **▲/▼/◀/▶** to select the picture, and then press **[DISP.]** to set.
(Repeat this step.)



- [] appears on the selected pictures. If [DISP.] is pressed again, the setting is cancelled.

4 (When [Delete Multi] is selected) Press **[MENU/SET]**.



- Confirmation screen is displayed. Pictures are deleted by selecting [Yes].

- The picture group taken in [Time Lapse Shot] (pictures with the  icon) will be treated as a single picture. Deleting the picture group will delete all pictures in the group. (P94)
- Do not turn the camera off while deleting. Use a battery with sufficient battery power or the AC adaptor (optional).
- Depending on the number of pictures to be deleted, it may take some time to delete them.

Setting the Menu

The camera comes with menus that allow you to choose the settings for taking pictures and playing them back just as you like and menus that enable you to have more fun with the camera and use it more easily.

In particular, the [Setup] menu contains some important settings relating to the camera's clock and power. Check the settings of this menu before proceeding to use the camera.

Setting menu items

Example: In the [Rec] menu, change [AF Mode] from [■] ([1-Area]) to [👤] ([Face Detection])

1 Press [MENU/SET].

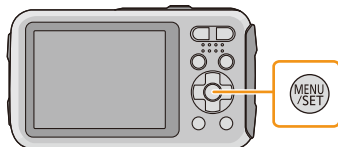

2 Press ◀/▶ to select menu and then press [MENU/SET].

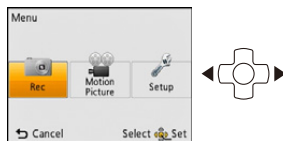

Menu	Description of settings
[Rec] (P78 to 97) (Recording Mode only)	The menu lets you set the Colouring, Sensitivity or Number of pixels, etc. of pictures you are recording.
[Motion Picture] (P98) (Recording Mode only)	This menu lets you set the setting for motion pictures such as recording quality.
[Playback] (P108 to 119) (Playback Mode only)	This menu lets you set the Protection, Cropping or Print Settings, etc. of recorded pictures.
[Setup] (P42 to 50)	This menu lets you perform the clock settings, beep tone settings and other settings which make it easier for you to operate the camera.

3 Press ▲/▼ to select the menu item and then press [MENU/SET].

Ⓐ Menu screen page

- It will switch to the next page when you reach the bottom.
(It will also switch by pressing the zoom button)

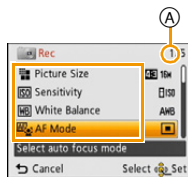

4 Press ▲/▼ to select the setting and then press [MENU/SET].

- Depending on the menu item, its setting may not appear or it may be displayed in a different way.



■ Close the menu

Press [🗑️/↶] until the screen returns to the recording/playback screen or press the shutter button half-way.

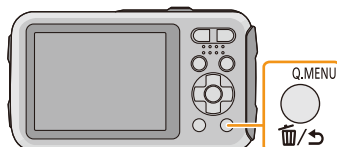

- There are functions that cannot be set or used depending on the modes or menu settings being used on the camera due to the specifications.

Using the Quick Menu

By using the Quick Menu, some of the menu settings can be easily found.

- The features that can be adjusted using Quick Menu are determined by the mode or a display style the camera is in.

1 Press [Q.MENU] when recording.

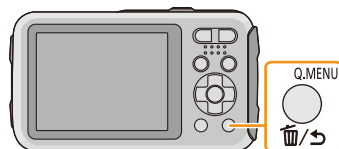

2 Press ▲/▼/◀/▶ to select the menu item and the setting and then press [MENU/SET] to close the menu.



About the Setup Menu

For details on how to select the [Setup] menu settings, refer to P40.





- [Clock Set], [Auto Power Off] and [Auto Review] are important items. Check their settings before using them.
- In Intelligent Auto Mode, only [Clock Set], [World Time], [Beep]*, [LED Light], [Language], [Stabilizer Demo.] can be set.
- * Available settings are different from other Recording Modes.

 [Precautions]	To maintain waterproof performance, display the things you need to check before use.
---	--

- Refer to P9 for details.

 [Clock Set]	Setting Date/Time.
---	--------------------













- Refer to P25 for details.

 [World Time]	<p>Set the time in your home area and travel destination. You can display the local times at the travel destinations and record them on the pictures you take.</p> <p>After selecting [Destination] or [Home], press ◀/▶ to select an area, and press [MENU/SET] to set.</p> <ul style="list-style-type: none"> • Set [Home] first thing after purchasing. [Destination] can be set after setting up [Home]. <p>✈ [Destination]: Travel destination area</p> <p>(A) Current time of the destination area (B) Time difference from home area</p> <p>🏠 [Home]: Your home area</p> <p>(C) Current time (D) Time difference from GMT (Greenwich Mean Time)</p> <div style="display: flex; justify-content: space-around; align-items: flex-start;"> <div style="text-align: center;"> <p>(A) </p> </div> <div style="text-align: center;"> <p>(B) </p> </div> <div style="text-align: center;"> <p>(C) </p> </div> <div style="text-align: center;"> <p>(D) </p> </div> </div>
--	--

- Press ▲ if you are using Summer Time [☀]. (The time will move forward by 1 hour.) Press ▲ once more to return to the normal time.
- If you cannot find the travel destination in the areas displayed on the screen, set by the time difference from the home area.

 [Travel Date]	<p>Departure date and return date of the travel as well as the name of the travel destination can be set. You can display the number of days that have passed when playing back the pictures and stamp it on the recorded pictures with [Text Stamp] (P108).</p>
	<p>[Travel Setup]:</p> <p>[SET]: Departure date and return date are set. Elapsed days (how many days after) of the travel are recorded.</p> <p>[OFF]</p> <ul style="list-style-type: none"> • The travel date is automatically cancelled if the current date is after the return date. If the [Travel Setup] is set to [OFF], [Location] will also be set to [OFF]. <p>[Location]:</p> <p>[SET]: Travel destination is recorded at the time of recording.</p> <p>[OFF]</p> <ul style="list-style-type: none"> • For details on how to enter characters, refer to “Entering Text” on P77.

- The number of days that have passed since the departure date can be printed out using the “PHOTOfunSTUDIO” bundled software on the CD-ROM (supplied).
- The travel date is calculated using the date in the clock setting and the departure date you set. If you set [World Time] to the travel destination, the travel date is calculated using the date in the clock setting and the travel destination setting.
- The travel date setting is memorised even if the camera is turned off.
- The number of days that have passed since the departure date is not recorded before the departure date.
- [Location] cannot be recorded when taking motion pictures.
- [Travel Date] cannot be set in the Intelligent Auto Mode. Setting of other Recording Mode will be reflected.

 [Beep]	This allows you to set the beep and shutter sound.	
	■) [Beep Level]:  ([Low])  ([High])  ([OFF]) ♪) [Beep Tone]:  [1]/  [2]/  [3]	♪) [Shutter Vol.]:  ([Low])  ([High])  ([OFF]) ♪) [Shutter Tone]:  [1]/  [2]/  [3]

 [Speaker Volume]	Adjust the volume of the speaker to any of the 7 levels.
---	--

- When you connect the camera to a TV, the volume of the TV speakers does not change. Also, when connected, no sound is output from the camera speakers.

 [Monitor Display]	Brightness, colour, or red or blue tint of the LCD monitor is adjusted.
	[Brightness]: Adjust the brightness. [Contrast · Saturation]: Adjust the contrast or clarity of colours. [Red Tint]: Adjust the red tint. [Blue Tint]: Adjust the blue tint.
	1 Select the settings by pressing ▲/▼, and adjust with ◀/▶. 2 Press [MENU/SET] to set.

- Some subjects may appear differently from actuality on the LCD monitor. However, this does not affect the recorded pictures.
- When [Monitor Luminance] is set to [High Angle], [Brightness] and [Contrast · Saturation] cannot be adjusted.

MON [Monitor Luminance]	These menu settings make it easier to see the LCD monitor when you are in bright places or when you are holding the camera high above your head.	
	[A*] ([Auto Power Monitor])*:	The brightness is adjusted automatically depending on how bright it is around the camera.
	[*] ([Power Monitor]):	The LCD monitor becomes brighter and easier to see even when taking pictures outdoors.
	[P*] ([High Angle])*:	The LCD monitor is easier to see when taking pictures with the camera held high above your head.
	[OFF]	
	* Can be set only during Recording Mode.	

- High Angle Mode is also cancelled if you turn the camera off or [Auto Power Off] is activated.
- The brightness of the pictures displayed on the LCD monitor is increased so some subjects may appear different from real life on the LCD monitor. However, this does not affect the recorded pictures.
- The LCD monitor automatically returns to normal brightness if no operations are performed for 30 seconds when recording in [Power Monitor]. Press any button to make the LCD monitor bright again.
- When [Monitor Luminance] is set, the usage time is reduced.

[Guide Line]	Set the pattern of the guidelines displayed when taking pictures. You can also set whether or not to have the recording information displayed when the guidelines are displayed. (P51)	
	[Rec. Info.]: [ON]/[OFF]	[Pattern]: []/[]

- When you align the subject on the horizontal and vertical guidelines or the cross point of these lines, you can take pictures with well-designed composition by viewing the size, the slope and the balance of the subject.
- The [Pattern] setting is fixed to [] in the Intelligent Auto Mode.
- The guideline is not displayed in the [Panorama Shot].



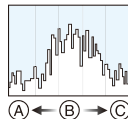







 [Histogram]	This allows you to set either to display or not display the histogram.
	[ON]/[OFF]
	<p>A Histogram is a graph that displays brightness along the horizontal axis (black to white) and the number of pixels at each brightness level on the vertical axis. It allows you to easily check a picture's exposure.</p> <p>(A) dark (B) optimal (C) bright</p>





- **When you take pictures with the flash or in dark places, the histogram is displayed in orange because the recorded picture and the histogram do not match each other.**
- The histogram is an approximation in Recording Mode.
- The Histogram of a picture may not match in the Recording Mode and the Playback Mode.
- The Histogram displayed in this camera does not match Histograms displayed by picture editing software used in PCs etc.
- Histograms are not displayed in the following cases.
 - Intelligent Auto Mode
 - Multi Playback
 - Recording motion pictures
 - Playback Zoom
 - Calendar

 [Video Rec Area]	Angle of view for motion picture recording can be checked.
	[ON]/[OFF]

- Motion picture recording area display is only an approximation.
- Recording area display may disappear when zooming to Tele depending on the picture size setting.
- It will be fixed to [OFF] during the Intelligent Auto Mode.

 [LED Light]	<p>This will illuminate the subject with a lamp when taking motion pictures in dark surrounding. Also, the LED can also be used as a simple light when necessary.</p> <p>[] ([On]): LED light  is turned on continuously while recording motion pictures.</p> <p>[] ([Off]):</p> <p>To use a simple light If you set to [], and press and hold down  () on the recording standby screen, the LED light will come on for 60 seconds. The LED light can be conveniently used as a simple light when you wish to illuminate your immediate surroundings in a dark location. To turn off the light at any time, press [/].</p> 
--	---

- Maximum illuminating range of the LED light is 50 cm (1.6 feet).
- The life of battery will decrease when the LED light is turned on constantly.
- In locations where the use of light is prohibited, set to [].
- It is fixed to [] in the following cases.
 - [Advanced Underwater]
 - [Panorama Shot]
 - [Baby1]/[Baby2] (Scene Mode)
- It is not available in Playback Mode.

 [Auto Power Off]	<p>The camera is automatically turned off if the camera has not been used for the time selected on the setting.</p> <p>[2MIN.]/[5MIN.]/[10MIN.]/[OFF]</p>
---	--

- [Auto Power Off] is set to [5MIN.] in the Intelligent Auto Mode.
- [Auto Power Off] does not work in the following cases.
 - When using the AC adaptor
 - When connecting to a PC or a printer
 - When using [Time Lapse Shot]
 - When recording or playing back motion pictures
 - During a Slide Show

 [Auto Review]	Set the length of time that the picture is displayed after taking the still picture.
	[1SEC.] [2SEC.] [HOLD]: The pictures are displayed until one of the buttons is pressed. [OFF]



- [Auto Review] is activated regardless of its setting in the following cases.
 - When using Auto Bracket
 - When using [Burst]
- The Auto Review function is fixed to [2 SEC.] in the following case.
 - Intelligent Auto Mode
- [Auto Review] does not work in the following cases.
 - When using [Time Lapse Shot]
 - When recording motion pictures.

 [No.Reset]	Reset the file number of the next recording to 0001.
---	--



- The folder number is updated and the file number starts from 0001.
- A folder number between 100 and 999 can be assigned.
When the folder number reaches 999, the number cannot be reset. We recommend formatting the card (P50) after saving the data on a PC or elsewhere.
- To reset the folder number to 100, format the built-in memory or the card first and then use this function to reset the file number.
A reset screen for the folder number will then appear. Select [Yes] to reset the folder number.

 [Reset]	The [Rec] or [Setup] menu settings are reset to the initial settings.
--	---

- When the [Rec] menu settings are reset during recording, the operation that resets the lens is also performed at the same time. You will hear the sound of the lens operating but this is normal and not indicative of malfunctioning.
- When the [Rec] menu settings are reset, data registered with [Face Recog.] will be also reset.
- When [Setup] menu settings are reset, the following settings are also reset.
 - The birthday and name settings for [Baby1]/[Baby2] and [Pet] in Scene Mode.
 - The [Travel Date] setting. (Departure date, return date, destination)
 - The [World Time] setting.
- The folder number and the clock setting are not changed.

 [Output]	Set to match the colour television system in each country or the type of TV.
	 ([Video Out]): [NTSC]: Video output is set to NTSC system. [PAL]: Video output is set to PAL system.  ([TV Aspect]): [16:9]: When connecting to a 16:9 screen TV. [4:3]: When connecting to a 4:3 screen TV.



- This will work when the AV cable (optional) is connected.



 [Rotate Disp.]	This mode allows you to display pictures vertically if they were recorded holding the camera vertically.
	 ([On]): Rotate pictures on a TV and the LCD monitor so that they are displayed vertically.  ([External Only]): Pictures are displayed vertically by rotating when played back on TV. [OFF]

- Refer to [P37](#) for information about how to play back pictures.
- When you play back pictures on a PC, they cannot be displayed in the rotated direction unless the OS or software is compatible with Exif. Exif is a file format for still pictures which allows recording information etc. to be added. It was established by "JEITA (Japan Electronics and Information Technology Industries Association)".
- It may not be possible to rotate pictures that have been recorded with other equipment.
- Pictures are not rotated during Multi Playback.

 [Version Disp.]	It is possible to check which version of firmware is on the camera.
--	---

 [Format]	The built-in memory or card is formatted. Formatting irretrievably deletes all the data so check the data carefully before formatting.
<ul style="list-style-type: none"> • Use a battery with sufficient battery power or the AC adaptor (optional) when formatting. Do not turn the camera off during formatting. • If a card has been inserted, only the card is formatted. To format the built-in memory, remove the card. • If the card has been formatted on a PC or other equipment, format it on the camera again. • It may take longer to format the built-in memory than the card. • If you cannot format, contact the dealer or Panasonic. 	

 [Language]	Set the language displayed on the screen.
<ul style="list-style-type: none"> • If you set a different language by mistake, select  from the menu icons to set the desired language. 	

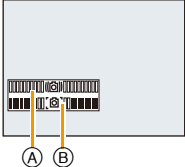
 [Stabilizer Demo.]	<p>Displays the amount of jitter the camera has detected.</p> <p>  Amount of jitter  Amount of jitter after correction </p> <div data-bbox="789 585 986 760" style="border: 1px solid black; padding: 5px;">  </div>
<ul style="list-style-type: none"> • The Stabiliser function is switched between [On] and [Off] every time [MENU/SET] is pressed. • [Stabilizer Demo.] is an approximation. 	

About the LCD Monitor

Press [DISP.] to change.

① LCD monitor

- When the menu screen appears, the [DISP.] button is not activated. During Playback Zoom, while playing back Motion Pictures and during a Slide Show, you can only select **E** or **G**.

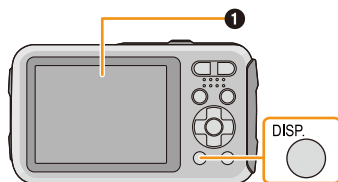

In Recording Mode

- A** Normal display*¹
- B** Normal display*¹
- C** No display
- D** No display (Recording guide line)*¹
- 2** Number of recordable pictures
- 3** Available recording time

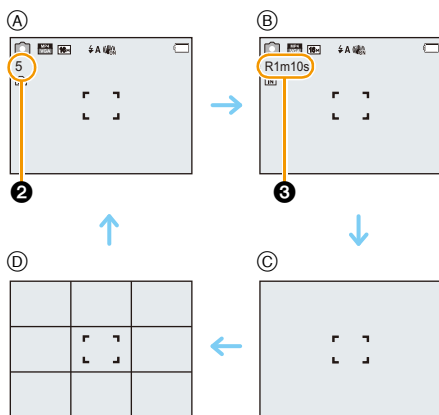

In Playback Mode

- E** Normal display
- F** Display with recording information*¹
- G** No display*²

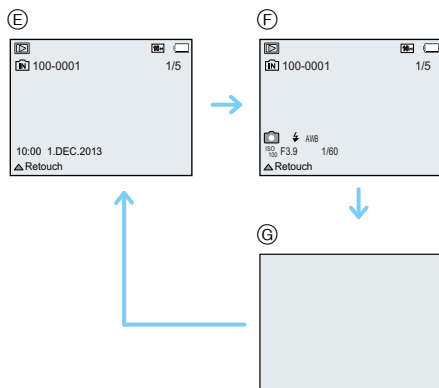

*1 If the [Histogram] in [Setup] menu is set to [ON], Histogram will be displayed.

*2 Name of the registered person in [Face Recog.] is displayed when [DISP.] is pressed.

Using the Zoom

Applicable modes:

You can zoom in to make people and objects appear closer or zoom out to record landscapes in wide angle.

To make subjects appear further away use (Wide)

Press [W] of the zoom button.

To make subjects appear closer use (Tele)

Press [T] of the zoom button.

■ Screen display

Example of display when Extra Optical Zoom (EZ), Intelligent Zoom and Digital Zoom are used together.

- Ⓐ Extra Optical Zoom indication
- Ⓑ Optical Zoom range
- Ⓒ Intelligent Zoom range
- Ⓓ Digital Zoom range
- Ⓔ Zoom magnification (approximation)

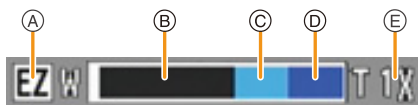

- **When using the Zoom function, an estimate of the focus range will appear in conjunction with the zoom display bar. (Example: 0.5 m (1.6 ft.) –∞)**

Optical Zoom

Zooms in without deteriorating the image quality.

Maximum magnification: 4×

Extra Optical Zoom (EZ)

This function works when any of the picture sizes (P78) indicated with **EZ** is selected. You can zoom in further than you can with the Optical Zoom without deteriorating the image quality.

Maximum magnification: 9×

(This includes the optical zoom magnification. The magnification level differs depending on [Picture Size] setting.)

- “EZ” is an abbreviation of “Extra Optical Zoom”.
- This function is not available in the following cases:
 - In Macro Zoom Mode
 - [Toy Effect] (Creative Control Mode)
 - [High Sens.] (Scene Mode)
 - When [Burst] in the [Rec] menu is set to [☐H] or [☐]
 - When recording motion pictures

Intelligent Zoom

This function works when [i.Resolution] (P89) in the [Rec] menu is set to [i.ZOOM]. You can zoom in up to twice the original zoom magnification while minimising the deterioration of the image quality.

- This will work automatically in Intelligent Auto Mode.
- This function is not available in the following cases:
 - In Macro Zoom Mode
 - [Toy Effect] (Creative Control Mode)
 - [High Sens.] (Scene Mode)
 - When [Burst] in the [Rec] menu is set to [☐H] or [☐]

Digital Zoom

This function works when [Digital Zoom] (P89) in the [Rec] menu is set to [ON]. Although the image quality deteriorates every time you zoom in further, you can zoom in up to four times the original zoom magnification.

- When using the [i.ZOOM], the maximum magnification of the Digital Zoom is limited to 2×
- We recommend using a tripod and the Self-timer (P59) for taking pictures.
- This function is not available in the following cases:
 - Intelligent Auto Mode
 - [Toy Effect]/[Miniature Effect] (Creative Control Mode)
 - [High Sens.] (Scene Mode)
 - When [Burst] in the [Rec] menu is set to [☐H] or [☐]

Taking Pictures Using the Built-in Flash

Applicable modes:          

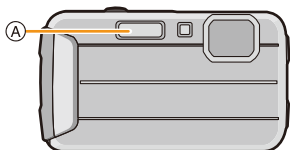

A Photo flash

Do not cover it with your fingers or other objects.

Switching to the appropriate flash setting

Set the flash to match the recording.

1 Press **▶** [].

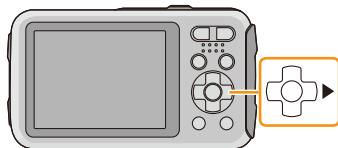

2 Press **▲/▼** to select the item and then press **[MENU/SET]**.

Item	Description of settings
[⚡A] ([Auto]) [i⚡A] ([iAuto]) ^{*1}	The flash is automatically activated when the recording conditions make it necessary.
[⚡A⊙] ([Auto/Red-Eye]) ^{*2}	The flash is automatically activated when the recording conditions make it necessary. It is activated once before the actual recording to reduce the red-eye phenomenon (eyes of the subject appearing red in the picture) and then activated again for the actual recording. • Use this when you take pictures of people in low lighting conditions.
[⚡] ([Forced Flash On])	The flash is activated every time regardless of the recording conditions. • Use this when your subject is back-lit or under fluorescent light.
[⚡S⊙] ([Slow Sync./Red-Eye]) ^{*2}	If you take a picture with a dark background landscape, this feature will slow the shutter speed when the flash is activated so that the dark background will become bright. Simultaneously, it reduces the red-eye phenomenon. • Use this when you take pictures of people in front of a dark background.
[⊙] ([Forced Flash Off])	The flash is not activated in any recording conditions. • Use this when you take pictures in places where the use of flash is not permitted.













*1 This can be set only when Intelligent Auto Mode is set. The icon changes depending on the type of subject and brightness. (P31)

*2 **The flash is activated twice. The subject should not move until the second flash is activated. Interval until the second flash depends on the brightness of the subject.**
[Red-Eye Removal] (P96) on the [Rec] menu is set to [ON], [⚡] appears on the flash icon.

■ Available Flash Settings in Recording Mode

The available flash settings depend on the Recording Mode.

(○: Available, —: Not available, ●: Scene Mode initial setting)

					
	○*	—	—	—	○
	○	○	○	—	○
	○	—	○	—	○
	○	●	○	—	○
	—	—	—	—	●
	—	—	—	●	○
	○	—	○	—	●





* [iA] is displayed.

- The flash setting may change if the Recording Mode is changed. Set the flash setting again if necessary.
- The flash setting is memorised even if the camera is turned off. However, the Scene Mode flash setting is reset to the initial setting when the Scene Mode is changed.
- Flash will not be activated when recording motion picture.

■ The available flash range

	Wide	Tele
In [ISO] in [Sensitivity]	30 cm (0.98 feet) to 4.4 m (14 feet)	1 m (3.3 feet) to 3 m (9.8 feet)

■ Shutter speed for each flash setting

Flash setting	Shutter speed (Sec.)	Flash setting	Shutter speed (Sec.)
	1/60 to 1/1300		1 or 1/8 to 1/1300*1
			1 or 1/4 to 1/1300*2
			

*1 The shutter speed changes depending on the [Stabilizer] setting.

*2 When [ISO] in [Sensitivity] is set.

- *1, 2: The shutter speed becomes a maximum of 1 second in the following cases.
 - When the Optical Image Stabiliser is set to [OFF].
 - When the camera has determined that there is very little jitter when the Optical Image Stabiliser is set to [ON].
- In Intelligent Auto Mode, shutter speed changes depending on the identified scene.
- The shutter speed for [Sports], [Snow], [Beach & Surf], [Advanced Underwater] and Scene Modes will be different from above table.

- If you bring the Flash too close to an object, the object may be distorted or discoloured by the heat or lighting from the Flash.
- Recording a subject from too close, or without sufficient flash will not provide the appropriate level of exposure, and may result in a picture that is too white or dark.
- When the Flash is being charged, the Flash icon blinks red, and you cannot take a picture even when you press the shutter button fully.
- If recording a subject without sufficient flash, the White Balance may not be properly adjusted.
- The effects of the flash may not be adequately achieved under the following conditions.
 - When [Burst] in the [Rec] menu is set to 
 - When the shutter speed is too fast
- It may take time to charge the Flash if you repeat taking a picture. Take a picture after the access indication disappears.
- The Red-Eye Reduction effect differs between people. Also, if the subject is far away from the camera or was not looking at the first Flash, the effect may not be evident.

Taking Close-up Pictures ([AF Macro]/[Macro Zoom])



Applicable modes:            





This mode allows you to take close-up pictures of a subject, e.g. when taking pictures of flowers.

1 Press  .



2 Press / to select the item and then press [MENU/SET].

Item	Description of settings
[AF  ([AF Macro])	You can take pictures of a subject as close as 5 cm (0.16 feet) from the lens by pressing the zoom button upmost to Wide (1×).
[ ([Macro Zoom])	Use this setting to get close to the subject and then further enlarge when taking the picture. You can take a picture with the Digital Zoom up to 3× while maintaining the distance to the subject for the extreme Wide position [5 cm (0.16 feet)]. • The image quality is poorer than during normal recording. • Zoom range will be displayed in blue. (digital zoom range)
[OFF]	—

- We recommend using a tripod and the Self-timer.
- We recommend setting the flash to  when you take pictures at close range.
- If the distance between the camera and the subject is beyond the focus range of the camera, the picture may not be properly focused even if the focus indication lights.
- When a subject is close to the camera, the effective focus range is significantly narrowed. Therefore, if the distance between the camera and the subject is changed after focusing on the subject, it may become difficult to focus on it again.
- Macro Mode gives priority to a subject close to the camera. Therefore, if the distance between the camera and the subject is far, it takes longer to focus on it.
- When you take pictures at close range, the resolution of the periphery of the picture may decrease slightly. This is not a malfunction.
- [] cannot be set in the following cases.
 - [Toy Effect]/[Miniature Effect] (Creative Control Mode)
 - When [AF Mode] is set to []
 - When [Burst] is set to [] or []

Taking Pictures with the Self-timer

Applicable modes: 

1 Press ◀ [⏻].

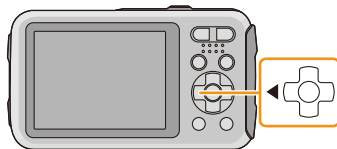

2 Press ▲/▼ to select the item and then press [MENU/SET].

Item	Description of settings
[⏻ ₁₀] ([10sec.])	Picture is taken 10 seconds after shutter is pressed.
[⏻ ₂] ([2sec.])	Picture is taken 2 seconds after shutter is pressed. • When using a tripod, etc., this setting is a convenient way to avoid the jitter caused by pressing the shutter button.
[OFF]	—

3 Press the shutter button halfway to focus and then press it fully to take the picture.

- The self-timer indicator (A) blinks and the shutter is activated after 10 seconds (or 2 seconds).

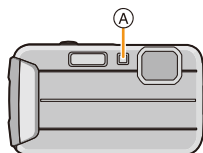
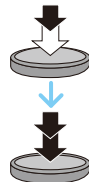
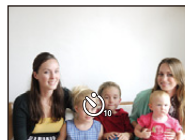

- When you press the shutter button once fully, the subject is automatically focused just before recording. In dark places, the Self-timer indicator will blink and then may turn on brightly, operating as an AF Assist Lamp to allow the camera to focus on the subject.
- We recommend using a tripod when recording with the Self-timer.
- Self-timer is disabled in the following cases.
 - When using [Time Lapse Shot]
 - When recording motion pictures

Compensating the Exposure

Applicable modes: 

Use this function when you cannot achieve appropriate exposure due to the difference in brightness between the subject and the background.

Underexposed



Compensate the exposure towards positive.

Properly exposed



Overexposed



Compensate the exposure towards negative.

- 1 Press **▲** [] until [Exposure] appears.



- 2 Press **◀/▶** to compensate the exposure and then press [MENU/SET].

- The exposure compensation value appears on the screen.
- Select [0 EV] to return to the original exposure.

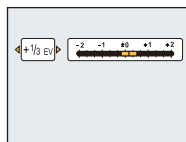

- EV is an abbreviation of [Exposure Value], a unit indicating the amount of exposure. The EV changes with the aperture value or the shutter speed.
- The set exposure value is memorised even if the camera is turned off.
- The compensation range of the exposure will be limited depending on the brightness of the subject.
- You cannot use the Exposure Compensation in following condition.
 - [Starry Sky] (Scene Mode)

Taking Pictures Using Auto Bracket

Applicable modes: 

In this mode, 3 pictures are automatically recorded in the selected exposure compensation range each time the shutter button is pressed.

With Auto Bracket ± 1 EV

1st picture



± 0 EV

2nd picture



-1 EV

3rd picture



$+1$ EV



- 1 Press **▲** [] until [Auto Bracket] appears.

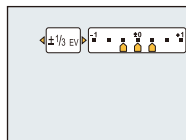

- 2 Press **◀/▶** to set the compensation range of the exposure and then press [MENU/SET].

- When you do not use Auto Bracket, select [OFF] (± 0).



- When Auto Bracket is set, [] is displayed on the screen.
- When taking pictures using Auto Bracket after setting the exposure compensation range, the pictures taken are based on the selected exposure compensation range.
- The exposure may not be compensated with Auto Bracket depending on the brightness of the subject.
- [] is set for the flash when Auto Bracket is set.
- You cannot use the Auto Bracket in following conditions.
 - [Toy Effect]/[Miniature Effect] (Creative Control Mode)
 - [Starry Sky] (Scene Mode)
 - When using [Time Lapse Shot]
 - When recording motion pictures

Taking Pictures with different image effects

(Creative Control Mode)

Recording Mode:

This mode records with additional image effects. You can set the effects to add by selecting example images and checking them on the screen.

- 1 Press [MODE].
- 2 Press ▲/▼/◀/▶ to select [Creative Control], and then press [MENU/SET].
- 3 Press ▲/▼ to select image effects and then press [MENU/SET].

- The image effect of the selected example image will be applied in a preview display (A).
- A brief description of selected image effect appears when you press [DISP].

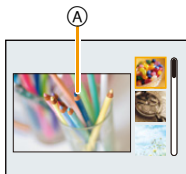

- To change the Creative Control Mode, press [MENU/SET], select [Creative Control] using ▲/▼/◀/▶, and then press [MENU/SET].
- The displayed image on the recording screen and the preview of the selected image effect may differ from the actual recorded image.
- The Creative Control Mode setting is stored even after turning off this unit.
- White Balance will be fixed to [AWB].
- The following cannot be set as the camera adjusts automatically.
– [Sensitivity]

* These pictures are examples to show the effect.

[Expressive]



This effect emphasises the colour to make a pop art picture.

[Retro]

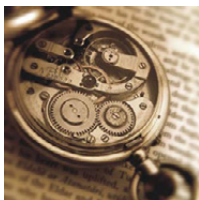

This effect gives a faded image.

[High Key]



This effect adds a bright, airy and soft feel to the overall image.

- If you select this effect with [Panorama Shot], the effect may not be apparent in places with insufficient brightness.

[Low Key]



This effect adds a dark and relaxing feel to the overall image and enhances bright parts.

[Sepia]

This effect creates a sepia image.

[Dynamic Monochrome]

This effect gives a higher contrast to create an impressive black and white picture.

[Impressive Art]

This effect gives your photo a dramatic contrast look.

- If you select this effect with [Panorama Shot], seams between pictures may become noticeable.

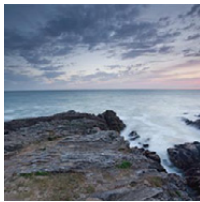
[High Dynamic]

This effect produces the optimum brightness for both dark and bright parts.

[Cross Process]

This effect gives your photo a dramatic colour look.

Items that can be set

Colour	Green tone/Blue tone/Yellow tone/Red tone
--------	---

- Press ◀/▶ to select the colour to enhance, and press [MENU/SET].

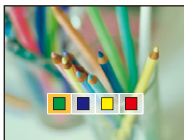
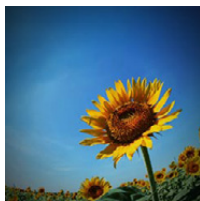
**[Toy Effect]**

This effect reduces peripheral brightness to give the impression of a toy camera.

Items that can be set

Colour	Orange emphasised	↔	Blue emphasised
--------	-------------------	---	-----------------

- Press ◀/▶ to select the colour tone, and press [MENU/SET].

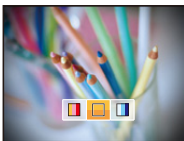

[Miniature Effect]



This effect blurs peripheral areas to give the impression of a diorama.

- Display of the recording screen will be delayed more than usual and the screen will look as if frames are being dropped.
- No sound is recorded in motion pictures.
- Approximately 1/8 of the time period is recorded. (If you record for 8 minutes, the resulting motion picture recording will be approximately 1 minute long.)
The displayed available recording time is approximately 8 times. When switching to Recording Mode, please check the available recording time.
- When taking pictures of a large size, the screen may turn black after taking the picture because of signal processing. This is not a malfunction.

[One Point Color]

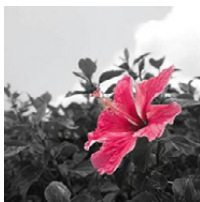

This effect leaves one selected colour to emphasise impressiveness.

■ Set the colour to leave in





- 1 Fit the colour you want to leave in the frame at the centre of the screen, and then press [MENU/SET].**
 - If you press [DISP.], you will return to step **1**.
- 2 Check the colour you have set, and then press [MENU/SET].**
 - The set colour is memorised even if the camera is turned off. In that case, the operation starts from step **2**.



- Depending on the subject, the set colour may not be left in.

Take the Outdoors Scene Expressively

Recording Mode:    

By setting the Recording Mode to [], [], [] or [] pictures can be taken more effectively matching the conditions such as sports, snow, beach & surf.

- Tone of the colour of the image may change when picture is taken with unmatched usage.
- The following cannot be set as the camera adjusts automatically.
 - [Sensitivity]/[i.Exposure]/[i.Resolution]/[Color Mode]/[Red-Eye Removal]

[Sports]

Setting for when you want to take pictures of sports scenes or other fast-moving events.

- Shutter speed may slow down up to 1 second.
- This mode is suitable for taking pictures of subjects at distances of 5 m (16 feet) or more.

[Snow]

This allows you to take pictures that show the snow as white as possible at a ski resort or a snow-covered mountain.

- To prevent water leakage, make sure that there are no foreign objects, such as sand, hair, dust, etc., clamped and close the side door all the way until it clicks. Also, read “(Important) About the Waterproof/Dustproof and Anti-shock Performance of the Camera” (P8) before using the camera.

[Beach & Surf]

This mode is optimal for taking pictures to 3 m (10 feet) underwater and at the beach.

- To prevent water leakage, make sure that there are no foreign objects, such as sand, hair, dust, etc., clamped and close the side door all the way until it clicks. Also, read “(Important) About the Waterproof/Dustproof and Anti-shock Performance of the Camera” (P8) before using the camera.
- Dip the camera in fresh water in a shallow container for 10 minutes or less after using it, then wipe the water off with dry soft cloth. (P11)

[Advanced Underwater]

This mode is optimal for taking pictures at depths of 3 m (10 feet) to 7 m (23 feet).

You can use [Color Reproduction] (P95) in the [Rec] menu and take pictures underwater without losing the red tinge.

- * This camera has a waterproof/dustproof function equivalent to "IP68". It is possible to take pictures in 7 m (23 feet) depth for 60 minutes.

■ Fixing the focus underwater (AF Lock)

You can fix the focus before taking a picture with AF lock. This is useful if you want to take pictures of a fast moving subject etc.

1 Aim the AF area at the subject.

2 Press ◀ to fix the focus.

- The AF lock icon appears when the subject is focused.
- Press ◀ again to cancel AF lock.
- When you press the zoom button, the AF lock is cancelled. In this case, focus on the subject and fix the focus again.
- You cannot set to AF lock when [AF Mode] is set to [AF-ON].

■ To beautifully record the underwater red tinge (Underwater colour reproduction)

Subjects appear blue in pictures taken underwater. Using [Color Reproduction] in the [Rec] menu will allow pictures to be taken without the subjects losing their red tone.

1 Select [Color Reproduction] in the [Rec] menu.

2 Press ▲/▼ to select the effect, and then press [MENU/SET].

- You can select the effect of [HIGH], [MEDIUM], [LOW], or [OFF].

- Ichikawa Soft Laboratory has studied colour loss in water based on the results of measurements of a large number of colour samples actually conducted in the ocean, and has developed "Natural Light Technology" to reproduce vivid, accurate colours based on ongoing research into colour reproduction of pictures taken underwater.*

[Color Reproduction] in the [Rec] menu and [Color Reproduction] under [Retouch] in the [Playback] menu make use of this technology.

- * "Natural Light Technology" is the technology behind "SILKYPIX Marine Photography", Ichikawa Soft Laboratory's digital reproduction software designed for underwater pictures.



<http://www.isl.co.jp/SILKYPIX/marine/p/>

- To prevent water leakage, make sure that there are no foreign objects, such as sand, hair, dust, etc., clamped and close the side door all the way until it clicks. Also, read "(Important) About the Waterproof/Dustproof and Anti-shock Performance of the Camera" (P8) before using the camera.
- Dip the camera in fresh water in a shallow container for 10 minutes or less after using it, then wipe the water off with dry soft cloth. (P11)
- If there is a substantial amount of matter in the water, set flash to [OFF].
- [Color Reproduction] is initially set to [LOW] on the camera.

Taking panorama pictures ([Panorama Shot])

Recording Mode: 

Pictures are recorded continuously while moving the camera horizontally or vertically, and are combined to make a single panorama picture.

- 1** Press [MODE].
- 2** Press ▲/▼/◀/▶ to select [Panorama Shot], and then press [MENU/SET].
- 3** Press ▲/▼ to select the recording direction and then press [MENU/SET].

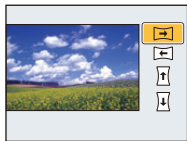

- 4** Press ▲/▼ to select the image effect, and then press [MENU/SET].
 - You can add the same image effect as the Creative Control Mode with the same operation as the Creative Control Mode. (except for [Toy Effect] and [Miniature Effect])
 - Read P63–66 for details on the respective effects.
 - If you are not going to add an image effect, select [OFF].
- 5** After confirming the recording direction, press [MENU/SET].
 - A horizontal/vertical guide is displayed.
If you press ▶, you will return to step 3.
- 6** Press the shutter button halfway to focus.

7 Press the shutter button fully and record a picture while moving the camera in a small circle in the direction selected in Step 3.

Recording from left to right

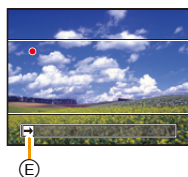
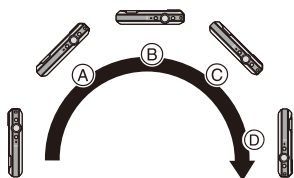

Trace a half-circle with the camera, taking about 4 seconds.

- Move the camera at a constant speed.

Pictures may not be able to be recorded properly if the camera is moved too fast or slow.

(A) 1 second

(D) 4 seconds

(B) 2 seconds

(E) Recording direction and panning (Guide)

(C) 3 seconds

8 Press the shutter button once again to end the still picture recording.

- Recording can also be ended by keeping the camera still while recording.

■ Technique for Panorama Shot Mode

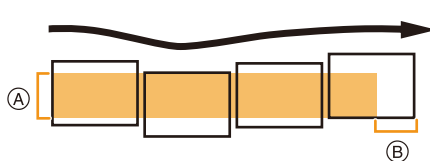

- (A) Move the camera in the recording direction without shaking it. If the camera shakes too much, pictures may not be able to be recorded, or the recorded panorama picture may become narrower (smaller).
- (B) Move the camera towards the edge of the range you wish to record. (The edge of the range will not be recorded in the last frame)

- The zoom position is fixed to Wide.
- The focus, white balance, and exposure are fixed at the optimum values for the first picture. As a result, if the focus or brightness changes substantially during recording, the entire panorama picture may not be recorded at the suitable focus or brightness.
- White Balance is fixed to [AWB] while an image effect is applied.
- When multiple pictures are combined to create a single panorama picture, the subject may appear distorted or the connection points may be noticeable in some cases.
- The number of recording pixels in the horizontal and vertical directions of the panorama picture varies depending on the recording direction and the number of combined pictures. The maximum number of pixels is shown below.

Recording direction	Horizontal Resolution	Vertical Resolution
Horizontal	3200 pixels	720 pixels
Vertical	960 pixels	3200 pixels

- A panorama picture may not be able to be created, or the pictures may not be combined properly when recording the following subjects or under the recording conditions below.
 - Subjects with a single, uniform colour or repetitive pattern (such as the sky or a beach)
 - Moving subjects (person, pet, car, waves, flowers blowing in the breeze, etc.)
 - Subjects where the colour or patterns change in a short time (such as an image appearing on a display)
 - Dark places
 - Locations with flickering light sources such as fluorescent lights or candles

■ About playback

	▲	Start panorama playback*1/Pause*2
	▼	Stop

*1 If you have filtered images for playback by using [Slide Show] (P99) or [Filtering Play] (P101), the selection screen appears. Press ▲/▼ to select [Play Panorama], and then press [MENU/SET].

*2 You can perform frame-by-frame forward/rewind by pressing ►/◀ during a pause.

Taking pictures that match the scene being recorded (Scene Mode)

Recording Mode: 

When you select a Scene Mode to match the subject and recording situation, the camera sets the optimal exposure and hue to obtain the desired picture.

- 1 Press [MODE].
- 2 Press ▲/▼/◀/▶ to select [Scene Mode], and then press [MENU/SET].
- 3 Press ▲/▼/◀/▶ to select the Scene Mode and then press [MENU/SET].

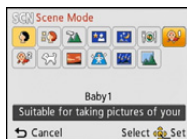

- To change the Scene Mode, press [MENU/SET], select [Scene Mode] using ▲/▼/◀/▶, and then press [MENU/SET].
- The following cannot be set in Scene Mode as the camera adjusts automatically.
 - [Sensitivity]/[i.Exposure]/[i.Resolution]/[Color Mode]

[Portrait]

When taking pictures of people outdoors during the daytime, this mode allows you to improve the appearance and make their skin tones look healthier.

■ Technique for Portrait Mode

To make this mode more effective:

- 1 Press and hold down the zoom button as far as possible to Tele.
- 2 Move close to the subject to make this mode more effective.

[Soft Skin]

When taking pictures of people outdoors during the daytime, this mode enables the texture of their skin to appear even softer than with [Portrait]. (It is effective when taking pictures of people from the chest up.)

■ Technique for Soft Skin Mode

To make this mode more effective:

- 1 Press and hold down the zoom button as far as possible to Tele.
- 2 Move close to the subject to make this mode more effective.

- If a part of the background etc. is a colour close to skin colour, this part is also smoothed.
- This mode may not be effective when there is insufficient brightness.

[Scenery]

This allows you to take pictures of a wide landscape.

[Night Portrait]

This allows you to take pictures of a person and the background with near real-life brightness.

■ Technique for Night Portrait Mode

- **Use the flash. (You can set to [].)**
 - Ask the subject not to move while taking a picture.
- We recommend using a tripod and the Self-timer for taking pictures.
 - Shutter speed may slow down up to 8 seconds.
 - The shutter may remain closed (max. about 8 sec.) after taking the picture because of signal processing. This is not a malfunction.
 - Noise may become visible when you take pictures in dark places.

[Night Scenery]

This allows you to take vivid pictures of the nightscape.

- We recommend using a tripod and the Self-timer for taking pictures.
- Shutter speed may slow down up to 8 seconds.
- The shutter may remain closed (max. about 8 sec.) after taking the picture because of signal processing. This is not a malfunction.
- Noise may become visible when you take pictures in dark places.

[Food]

This mode allows you to take pictures of food with a natural hue without being affected by the ambient light in restaurants, etc.

[Baby1]/[Baby2]

This takes pictures of a baby with a healthy complexion. When you use the flash, the light from it is weaker than usual.

It is possible to set different birthdays and names for [Baby1] and [Baby2]. You can select to have these appear at the time of playback, or have them stamped on the recorded image using [Text Stamp] (P108).

■ Birthday/Name setting

1 Press ▲/▼ to select [Age] or [Name] and then press [MENU/SET].

2 Press ▲/▼ to select [SET] and then press [MENU/SET].

3 Enter the birthday or name.

Birthday: ◀/▶: Select the items (year/month/day)

▲/▼: Setting

[MENU/SET]: Set

Name: For details on how to enter characters, refer to "Entering Text" on P77.

- When the birthday or name is set, [Age] or [Name] is automatically set to [ON].
- If [ON] is selected when the birthday or name has not been registered, the setting screen appears automatically.

4 Press ▼ to select [Exit] and then press [MENU/SET] to finish.

■ To cancel [Age] and [Name]

Select the [OFF] setting in step 2.

- The age and name can be printed out using the "PHOTOfunSTUDIO" bundled software on the CD-ROM (supplied).
- If [Age] or [Name] is set to [OFF] even when the birthday or name has been set, the age or name will not be displayed.
- Shutter speed may slow down up to 1 second.

[Pet]

Select this when you want to take pictures of a pet such as a dog or a cat. You can set your pet's birthday and name.

For information about [Age] or [Name], refer to [Baby1]/[Baby2] on [P75](#).

[Sunset]

Select this when you want to take pictures of a sunset view. This allows you to take vivid pictures of the red colour of the sun.

[High Sens.]

This mode minimises the jitter of the subjects, and enables you to take pictures of these subjects in dimly lit rooms.

■ Picture Size

Select the picture size of 3M (4:3), 2.5M (3:2), 2M (16:9) or 2.5M (1:1).

[Starry Sky]

This mode allows you to take vivid pictures of a starry sky or a dark subject.

■ Setting the shutter speed

Select a shutter speed of [15 sec.], [30 sec.] or [60 sec.].

- Press the shutter button fully to display the countdown screen. Do not move the camera after this screen is displayed. When countdown finishes, [Please wait...] is displayed for the same length of time as the set shutter speed for signal processing.

■ Technique for Starry Sky Mode

- The shutter opens for 15, 30 or 60 seconds. Be sure to use a tripod. We also recommend taking pictures with the self-timer.

[Glass Through]

Objects in the distance are prioritised for focus.

This mode is ideal for taking pictures of scenery and other landscapes through clear glass, such as in vehicles or buildings.

- The camera may focus on the glass if it is dirty or has dust on it.
- The pictures taken may not look natural if the glass is coloured. When this happens, change the white balance settings. ([P80](#))

Entering Text

It is possible to enter babies' and pets' names and the locations when recording. When a screen that looks like the one on the right is displayed, you can enter characters. (Only alphabetical characters and symbols can be entered.)



1 Press ▲/▼/◀/▶ to select text and then press [MENU/SET] to register.

- Move the cursor to [a] and then press [MENU/SET] to switch text between [A] (capitals), [a] (lower case), [1] (numbers) and [&] (special characters).
- To continuously enter the same character, move the cursor by pressing [T] on the zoom button.
- The following operations can be performed by moving the cursor to the item and pressing [MENU/SET]:
 - []: Enter a blank
 - [Delete]: Delete a character
 - [◀]: Move the entry position cursor to the left
 - [▶]: Move the entry position cursor to the right
- The following characters and numbers can be entered.
 - A maximum of 30 characters can be entered (Maximum of 9 characters when setting names in [Face Recog.]).
 - A maximum of 15 characters can be entered for [\], [[], []], [•] and [-] (Maximum of 6 characters when setting names in [Face Recog.]).

2 Press ▲/▼/◀/▶ to move the cursor to [Set] and then press [MENU/SET] to end text input.

- Text can be scrolled if all of the entered text does not fit on the screen.
- It is displayed in order of location, [Name] ([Baby1]/[Baby2], [Pet]), [Name] ([Face Recog.]).

Using the [Rec] Menu

For details on [Rec] menu settings, refer to P40.

[Picture Size]

Applicable modes:          

Set the number of pixels. The higher the numbers of pixels, the finer the detail of the pictures will appear even when they are printed onto large sheets.

Settings	Picture Size
[4:3 16M]	4608×3456
[4:3 10 ^{EV} M]*	3648×2736
[4:3 5 ^{EV} M]	2560×1920
[4:3 3 ^{EV} M]*	2048×1536
[4:3 1 ^{EV} M]*	1280×960
[4:3 0.3 ^{EV} M]	640×480
[3:2 14M]	4608×3072
[16:9 12M]	4608×2592
[1:1 12M]	3456×3456

* This item cannot be set in the Intelligent Auto Mode.

4:3 : Aspect ratio of a 4:3 TV

3:2 : Aspect ratio of a 35 mm film camera

16:9 : Aspect ratio of a high-definition TV, etc.

1:1 : Square aspect ratio

- In specific modes, Extra Optical Zoom cannot be used, and the picture size for [EV] is not displayed. For details regarding modes in which Extra Optical Zoom cannot be used, refer to P53.
- Pictures may appear mosaic depending on the subject and the recording conditions.



[Sensitivity]

Applicable modes:              

This allows the Sensitivity to light (ISO sensitivity) to be set. Setting to a higher figure enables pictures to be taken even in dark places without the resulting pictures coming out dark.

Settings	Description of settings
 [iISO] ((i.iISO))	The ISO sensitivity is adjusted according to the movement of the subject and the brightness. <ul style="list-style-type: none"> • Maximum [1600] • The shutter speed is not fixed when the shutter button is pressed halfway. It is continuously changing to match the movement of the subject until the shutter button is pressed fully.
[100]	The ISO sensitivity is fixed to various settings.
[200]	
[400]	
[800]	
[1600]	

	[100]  [1600]	
Recording location (recommended)	When it is light (outdoors)	When it is dark
Shutter speed	Slow	Fast
Noise	Less	Increased
Jitter of the subject	Increased	Less

- For the focus range of flash when  [iISO] is set, refer to [P57](#).
- The ISO sensitivity is automatically set under the following conditions.
 - When recording motion pictures
 - When [Burst] in the [Rec] menu is set to  [H] or  [L]

[White Balance]

Applicable modes:       

In sunlight, under incandescent lights or in other such conditions where the colour of white takes on a reddish or bluish tinge, this item adjusts to the colour of white which is closest to what is seen by the eye in accordance with the light source.

Settings	Description of settings
[AWB] ([Auto White Balance])	Automatic adjustment
[☀] ([Daylight])	When taking pictures outdoors under a clear sky
[☁] ([Cloudy])	When taking pictures outdoors under a cloudy sky
[☷] ([Shade])	When taking pictures outdoors in the shade
[☹] ([Incandescent])	When taking pictures under incandescent lights
[📷] ([White Set])	Value set by using [📷]SET
[📷]SET ([White Set Setting])	Set manually

- Under fluorescent lighting, LED lighting fixture etc., the appropriate White Balance will vary depending on the lighting type, so use [AWB] or [📷]SET.
- The White Balance setting is memorised even if the camera is turned off. (However, the White Balance setting for a Scene Mode returns to [AWB] when the Scene Mode is changed.)
- White Balance is fixed to [AWB] in following cases.
 - [Scenery]/[Night Portrait]/[Night Scenery]/[Food]/[Sunset]/[Starry Sky] (Scene Mode)

■ Auto White Balance

Depending on the conditions prevailing when pictures are taken, the pictures may take on a reddish or bluish tinge. Furthermore, when a multiple number of light sources are being used or there is nothing with a colour close to white, Auto White Balance may not function properly. In this case, set the White Balance to a mode other than [AWB].

- 1 Auto White Balance will work within this range
 - 2 Blue sky
 - 3 Cloudy sky (Rain)
 - 4 Shade
 - 5 Sunlight
 - 6 White fluorescent light
 - 7 Incandescent light bulb
 - 8 Sunrise and sunset
 - 9 Candlelight
- K=Kelvin Colour Temperature

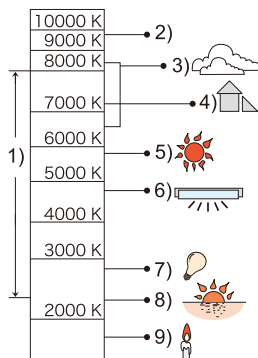

Setting the White Balance manually

Set the White Balance value. Use to match the condition when taking photographs.

- 1 Select [SET] and then press [MENU/SET].
- 2 Aim the camera at a sheet of white paper etc. so that the frame in the centre is filled by the white object only and then press [MENU/SET].
 - White Balance may not be set when the subject is too bright or too dark. Set the White Balance again after adjusting to appropriate brightness.
 - Exit the menu after it is set.

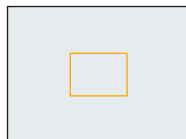

■ About [👤] ([Face Detection])

The following AF area frames are displayed when the camera detects the faces.

Yellow:

When the shutter button is pressed halfway, the frame turns green when the camera is focused.

White:

Displayed when more than one face is detected. Other faces that are the same distance away as the faces within the yellow AF areas are also brought into focus.



- Under certain picture-taking conditions including the following cases, the face detection function may fail to work, making it impossible to detect faces. [AF Mode] is switched to [☰] ([□]) while motion pictures are taken).
 - When the face is not facing the camera
 - When the face is at an angle
 - When the face is extremely bright or dark
 - When there is little contrast on the faces
 - When the facial features are hidden behind sunglasses, etc.
 - When the face appears small on the screen
 - When there is rapid movement
 - When the subject is not a human being
 - When the camera is shaking
 - When Digital Zoom is used
 - Taking pictures underwater
- If the camera is registering something other than someone's face, change the settings to something other than [👤].

■ Setting up [AF Mode] ([AF Tracking])

Align the subject with the AF tracking frame, and then press ▼ to lock onto the subject.

Ⓐ AF tracking frame

- AF area will be displayed in yellow when a subject is recognised, and focus will automatically adjust continuously following the subject's movement (Dynamic tracking).
- AF tracking is cancelled when ▼ is pressed again.

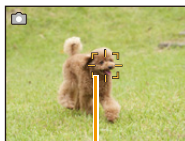

- Dynamic tracking function may not work in the following cases:
 - When the subject is too small
 - When the recording location is too dark or bright
 - When the subject is moving too fast
 - When the background has the same or similar colour to the subject
 - When jitter is occurring
 - When using the zoom
 - Taking picture underwater
- When the lock fails, the AF tracking frame will turn red and then disappear. Press ▼ again.
- The camera records pictures with [AF Mode] as [AF Mode] when locked or Dynamic Tracking is not working.

[Face Recog.]

Applicable modes:          

Face Recognition is a function which finds a face resembling a registered face and prioritises focus and exposure automatically. Even if the person is located towards the back or on the end of a line in a group photo, the camera can still take a clear picture.

Settings: [ON]/[OFF]/[MEMORY]

[Face Recog.] is initially set to [OFF] on the camera.

[Face Recog.] will turn [ON] automatically when the face image is registered.

• The following functions will also work with the Face Recognition function.

In Recording Mode

- Display of corresponding name when camera detects a registered face* (if name has been set for the registered face)



In Playback Mode

- Display of name and age (if information has been registered)
- Selective playback of pictures chosen from pictures registered with Face Recognition ([Category Selection] in [Filtering Play]).

* Names of up to 3 people are displayed. Precedence for the names displayed when taking pictures is determined according to the order of registration.

- During the Burst Mode, [Face Recog.] picture information can be attached to only the first picture.
- [Face Recog.] does not guarantee secure recognition of a person.
- Face Recognition may take more time to select and recognise distinctive facial features than regular face detection.
- Even when Face Recognition information has been registered, pictures taken with [Name] set to [OFF] will not be categorised by Face Recognition in [Category Selection] ([Filtering Play]).
- **Even when Face Recognition information is changed (P88), Face Recognition information for the pictures already taken will not be changed.**
For instance, if the name is changed, pictures recorded before the change will not be categorised by Face Recognition in [Category Selection] ([Filtering Play]).
- To change the name information of the pictures taken, perform the [REPLACE] in [Face Rec Edit] (P118). [Face Recog.] cannot be used in the following cases.
 - Recording Modes which do not allow setting to  of [AF Mode]
 - When recording motion pictures

Face Settings

You can register information such as names and birthdays for face images of up to 6 people. Registration can be facilitated by taking multiple face images of each person. (up to 3 pictures/registration)

- 1 Select [Face Recog.] on the [Rec] menu and then press [MENU/SET].
- 2 Press ▲/▼ to select [MEMORY] and then press [MENU/SET].
- 3 Press ▲/▼/◀/▶ to select the Face Recognition frame that is not registered, and then press [MENU/SET].

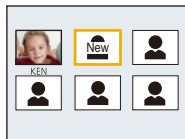

- 4 Take the picture adjusting the face with the guide.
 - Confirmation screen is displayed. It is executed when [Yes] is selected.
 - The faces of subjects other than people (pets, etc.) cannot be registered.
 - When [DISP.] is pressed, an explanation appears for taking face images.

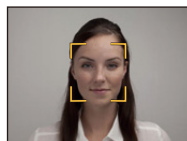

5 Select item to edit with ▲/▼, and then press [MENU/SET].

Item	Description of settings
[Name]	<ol style="list-style-type: none"> ① Press ▼ to select [SET] and then press [MENU/SET]. ② Enter the name. <ul style="list-style-type: none"> • For details on how to enter characters, refer to “Entering Text” section on P77.
[Age]	<ol style="list-style-type: none"> ① Press ▼ to select [SET] and then press [MENU/SET]. ② Press ◀/▶ to select the items (Year/Month/Day), and then press ▲/▼ to set and then press [MENU/SET].
[Focus Icon]	<p>Change the displayed focus icon when the subject is focused.</p> <p>Press ▲/▼ to select the focus icon, and then press [MENU/SET].</p>
[Add Images]	<p>To add additional face images.</p> <p>(Add Images)</p> <ol style="list-style-type: none"> ① Select the unregistered face recognition frame, and then press [MENU/SET]. ② Perform step 4 in “Face Settings”.
	<p>To delete one of the face images.</p> <p>(Delete)</p> <p>Press ◀/▶ to select the face image to delete, and then press [MENU/SET].</p> <ul style="list-style-type: none"> • If there is only one image registered, it cannot be deleted. • Confirmation screen is displayed. It is executed when [Yes] is selected.

- Exit the menu after it is set.

■ Point of recording when registering the face images

- Face front with eyes open and mouth closed, making sure the outline of the face, the eyes, or the eyebrows are not covered with the hair when registering.
- Make sure there is no extreme shading on the face when registering. (Flash will not flash during registration.)

(Good example for registering)

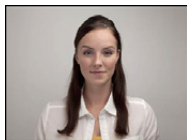

■ When it is not recognising during recording

- Register the face of same person indoors and outdoors, or with different expressions or angles. (P87)
- Additionally register at the location of recording.
- When a person who is registered is not recognised, correct by re-registering.
- Face Recognition may not be possible or may not recognise faces correctly even for registered faces, depending on the facial expression and environment.

Change or delete the information for a registered person

You can modify the pictures or information of an already registered person. You can also delete the information of the registered person.

- 1 Press **▼** to select [MEMORY] and press [MENU/SET].
- 2 Press **▲/▼/◀/▶** to select the face image to edit or delete and then press [MENU/SET].
- 3 Press **▲/▼** to select the item and then press [MENU/SET].

Item	Description of settings
[Info Edit]	Changing the information of an already registered person. Perform step 5 in "Face Settings".
[Priority]	The focus and exposure are preferentially adjusted for higher-priority faces. Press ▲/▼/◀/▶ to select the priority and then press [MENU/SET].
[Delete]	Deleting information of a registered person. • Confirmation screen is displayed. It is executed when [Yes] is selected.

- Exit the menu after it is set.

[i.Exposure]

Applicable modes: 

Contrast and exposure will be adjusted automatically when there is a big difference in brightness between the background and subject, to bring the image close to real life.

Settings: [ON]/[OFF]

- [i.●] in the screen turns yellow when [i.Exposure] is in effect.
- Even when the [Sensitivity] is set to [100], [Sensitivity] may be set higher than [100] if the picture is taken with [i.Exposure].
- Compensation effect may not be achieved depending on the conditions.

[i.Resolution]

Applicable modes: 

Pictures with sharp profile and resolution can be taken by using the Intelligent Resolution Technology.

Settings	Description of settings
[ON]	[i.Resolution] is activated.
[i.ZOOM]	[i.Resolution] is activated, and zoom magnification increased to 2 times while limiting deterioration of the picture.
[OFF]	—

- Refer to [P53](#) for information about the Intelligent Zoom.

[Digital Zoom]

Applicable modes: 

This can enlarge subjects even more than the Optical Zoom, Extra Optical Zoom, or [i.ZOOM].



Settings: [ON]/[OFF]



- Refer to [P53](#) for details.
- The setting is fixed to [ON] in Macro Zoom Mode.

[Burst]

Applicable modes:          

Pictures are taken continuously while the shutter button is pressed.

Settings	Description of settings	
[] ([Burst On])	Burst speed	approx. 1.3 pictures/second
	<ul style="list-style-type: none"> You can take pictures until the capacity of the built-in memory or the card is full. The burst speed becomes slower halfway. The exact timing of this depends on the type of card and the Picture Size. The focus is fixed when the first picture is taken. The exposure and White Balance are adjusted each time you take a picture. The Burst speed (pictures/second) may become slower depending on the recording environment, such as in dark places, if the ISO sensitivity is high etc. 	
[ H] ([Hi-Speed Burst])	Burst speed	approx. 8 pictures/second
	Number of recordable pictures	max. 100 pictures
<ul style="list-style-type: none"> This can be set only during Normal Picture Mode. The picture size is fixed to 3M (4:3), 2.5M (3:2), 2M (16:9) or 2.5M (1:1). The Burst speed changes according to the recording conditions. The number of Burst recording pictures are limited by the picture-taking conditions and the type and/or status of the card used. The number of Burst recording pictures may increase when you use a card with fast writing speed or card is formatted. The focus, zoom, exposure, White Balance, shutter speed and ISO sensitivity are fixed to the settings for the first picture. The ISO sensitivity is automatically adjusted. However, the ISO sensitivity is increased to make the shutter speed become high-speed. 		
[] ([Flash Burst])	Number of recordable pictures	max. 5 pictures
	<ul style="list-style-type: none"> Still pictures are taken continuously with flash. This can be set only during Normal Picture Mode. The picture size is fixed to 3M (4:3), 2.5M (3:2), 2M (16:9) or 2.5M (1:1). Settings for focus, zoom, exposure, shutter speed, ISO sensitivity, flash output are fixed to the first picture. The flash setting is fixed to [☞]. 	
[OFF]	—	

- Depending on the operating conditions, it may take time to take the next picture if you repeat the recording of pictures.
- **It may take time to save pictures taken in Burst Mode on the card. If you take pictures continuously while saving, the maximum number of recordable pictures decreases. For continuous shooting, use of a high speed memory card is recommended.**
- Burst Mode is not cancelled when the camera is turned off.
- If you take pictures in Burst Mode with the built-in memory, it will take time to write the picture data.
- The Burst Mode cannot be used in the following cases.
 - [Toy Effect]/[Miniature Effect] (Creative Control Mode)
 - [Starry Sky] (Scene Mode)
 - When using [Time Lapse Shot]
- When the Self-Timer is used, the number of recordable pictures in Burst Mode is fixed to 3 (5 pictures in []).
- **The flash setting is fixed to [] (except for []).**

[Time Lapse Shot]

Applicable modes: 

You can set the recording start time, the recording interval and the number of pictures, and automatically record subjects such as animals and plants as time elapses.

You can create motion pictures using [Time Lapse Video] in [Playback] menu. (P111)

- Set the date and time settings in advance. (P25)
- It cannot be recorded into the built-in memory. Please use a card.

■ Set the recording start time/interval/number of pictures

- 1 Press ▲/▼ to select the item and then press [MENU/SET].

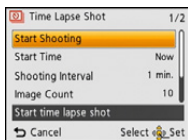

Item	Description of settings
[Start Time]	[Now]: Starts the recording by fully-pressing the shutter button.
	[Start Time Set]: You can set the time to start recording. Any time up to 24 hours ahead can be set. Select the start time (hours/minutes) with ◀/▶, adjust with ▲/▼, and then press [MENU/SET] to set.
[Shooting Interval] [Image Count]	Sets the number of pictures to be taken and the recording interval. Select the item (recording interval/number of pictures to be taken) with ◀/▶, adjust with ▲/▼, and then press [MENU/SET] to set. [Shooting Interval]: You can set the time ranging from 10 seconds to 1 minute in 10-second increments, and from 1 minute to 30 minutes in 1-minute increments. • The setting may be available from a 1-minute interval or 5-minutes interval depending on the shutter speed.
	[Image Count]: You can set the number of pictures ranging from 10 to 1000 in 10-picture increments.
[Alert]	[ON]: The user is notified that recording is to start by a warning sound and flashing AF assist lamp.
	[OFF]: There is no warning sound. Also, the AF assist lamp doesn't flash.

2 Press ▲/▼ to select [Start Shooting] and then press [MENU/SET].

3 Press the shutter button fully.

- The recording starts automatically.
 - If the recording interval is set to 40 seconds or more, this unit will turn off automatically while in recording standby. [Time Lapse Shot] is continued even with this unit turned off. When the recording start time arrives, this unit turns on automatically. To turn on this unit manually, press the camera [ON/OFF] button or press and hold [▶].
 - To stop the Time Lapse Shooting partway through, press [MENU/SET] or [▶] while this unit turned on, and end the recording on the displayed confirmation screen.
- This function is not for use in a security camera.
- **If you leave the unit somewhere to perform [Time Lapse Shot], please be careful of theft.**
 - **Recording for long periods in cold places such as ski resorts or places at high altitude, or in warm, wet environments may cause a malfunction, so please be careful.**
 - When the recording interval is set to a value of less than 1 minute and the previous recording has not finished yet, recording may be skipped.
 - We do not recommend using [Time Lapse Shot] while underwater.
 - When the recording warning is set to [ON], a warning sound will be emitted. Check this setting is suitable for the recording environment.
 - The unit is fixed to the zoom position prior to the start of recording.
 - We recommend to use a fully charged battery.
 - In situations that require longer recording time such as when recording in [Starry Sky] of the Scene Mode or when recording in a dark place, we recommend you use an AC adaptor (optional).
 - [Time Lapse Shot] will be cancelled partway through in the following cases.
 - When the charge on the battery runs out
 - When the number of recordable pictures drops to none
 - Do not connect the AV cable (optional) or the USB connection cable (supplied) during Time Lapse Shooting.

Playing back pictures taken in [Time Lapse Shot]

Pictures taken in [Time Lapse Shot] are stored in groups, each containing the series of pictures recorded in a single Time Lapse Shot. The [⏮] icon is displayed for the group.



- Deleting and editing in a group unit is possible. (For example, if you delete a picture group with [⏮], all the pictures in that group are deleted.)

■ Continuously playing back

Press ◀/▶ to select a picture with the [⏮] icon, and then press ▲.

- If you have filtered images for playback by using [Slide Show] (P99) or [Filtering Play] (P101), the selection screen appears. Press ▲/▼ to select [Sequential Play], and then press [MENU/SET].

• Operations during continuous playback

	▲	Play/Pause
	▼	Stop
	◀	Fast rewind, Previous picture*
	▶	Fast forward, Next picture*

* These operations can be performed only in the Pause Mode.

■ Playing back each picture

1 Press ◀/▶ to select a picture with the [⏮] icon, and then press ▼.

2 Press ◀/▶ to select the picture.

- Press ▼ again to return to the normal playback screen.
- Operations similar to those for Normal Play can be used on the pictures in the group. (Multi playback, playback zoom, deleting the pictures, etc.)

- If you delete all pictures except one in the group, that picture will be saved as a single picture.

[Color Mode]

Applicable modes:         

Sets various colour effects, including making the picture sharper, brighter, or applying a sepia tone.

Settings	Description of settings
[STANDARD]	This is the standard setting.
[Happy] ^{*1}	Image with enhanced brightness and vividness.
[VIVID] ^{*2}	The picture becomes sharper.
[B&W]	The picture becomes black and white.
[SEPIA]	The picture becomes sepia.

*1 This can be set only when Intelligent Auto Mode is set.

*2 This can be set only during Normal Picture Mode.

[Color Reproduction]

Applicable modes:         

• Refer to P68 for details.

[AF Assist Lamp]

Applicable modes:         

AF assist lamp will illuminate the subject when the shutter button is pressed halfway, making it easier for the camera to focus when recording in low light conditions. (Larger AF area is displayed depending on the recording conditions.)

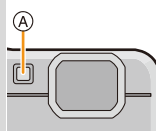

Settings: [ON]/[OFF]

- The effective distance of the AF Assist Lamp is a maximum of approximately 1.5 m (4.9 feet).
- When you do not want to use the AF Assist Lamp  (e.g. when taking pictures of animals in dark places), set the [AF Assist Lamp] to [OFF]. In this case, it will become more difficult to focus on the subject.
- [AF Assist Lamp] is fixed to [OFF] in the following cases.
 - [Scenery]/[Night Scenery]/[Sunset]/[Glass Through] (Scene Mode)



[Red-Eye Removal]

Applicable modes:        

When Red-Eye Reduction ([], []) is selected, Red-Eye Removal is performed whenever the flash is used. The camera automatically detects red-eye and corrects the picture.

Settings: [ON]/[OFF]

- Only available when [AF Mode] is set to [] and Face Detection is active.
- Under certain circumstances, red-eye cannot be corrected.

[Stabilizer]

Applicable modes:        

Using this mode, jitter during picture taking is detected, and the camera automatically compensates for the jitter, enabling jitter-free images to be taken.

When recording motion pictures, "Active Mode" (stabiliser for motion pictures) will automatically function. This decreases the jitter of the image when recording motion pictures while walking, etc.

Settings: [ON]/[OFF]

- During motion picture recording, this setting is fixed to [ON] and "Active Mode" is enabled. Note that "Active Mode" is disabled when [Rec Quality] is set to [VGA].
- In "Active Mode", stronger effect of the correction can be achieved at the wide end.
- The stabiliser function may not be effective in the following cases. Be careful of camera jitter when you press the shutter button.
 - When there is a lot of jitter
 - When the zoom magnification is high
 - In Digital Zoom range
 - When taking pictures while following a moving subject
 - When the shutter speed becomes slower to take pictures indoors or in dark places
- The setting is fixed to [OFF] in the following case.
 - [Starry Sky] (Scene Mode)

[Date Stamp]

Applicable modes:        

You can take a picture with date and time of recording.

Settings	Description of settings
[W/O TIME]	Stamp the year, month, and day.
[WITH TIME]	Stamp the year, month, day, hour, and minutes.
[OFF]	—

- Date information for pictures recorded with the [Date Stamp] set cannot be deleted.
- When printing pictures with [Date Stamp] at a shop or with a printer, the date will be printed on top of the other if you choose to print with the date.
- If the time has not been set, you cannot stamp with the date information.
- The setting is fixed to [OFF] in the following cases.
 - When using Auto Bracket
 - When using [Burst]
 - When recording motion pictures
- [Text Stamp], [Resize], and [Cropping] cannot be set for pictures recorded with [Date Stamp] set.
- Even if you take a picture with [Date Stamp] set to [OFF], it is possible to stamp dates onto the recorded pictures using [Text Stamp] (P108) or setup the Date print (P116, 129).

[Clock Set]

- Refer to P25 for details.

Using the [Motion Picture] Menu

For details on [Motion Picture] menu settings, refer to P40.

[Rec Quality]

Applicable modes:          

This sets up the picture quality of motion pictures.

Settings	Picture size/Bit rate	fps	Aspect ratio
[HD]	1280×720 pixels/Approx. 10 Mbps	25	16:9
[VGA]	640×480 pixels/Approx. 4 Mbps		4:3

• What is bit rate

This is the volume of data for a definite period of time, and the quality becomes higher when the number gets bigger. This unit is using the “VBR” recording method. “VBR” is an abbreviation of “Variable Bit Rate”, and the bit rate (volume of data for definite period of time) is changed automatically depending on the subject to record. Therefore, the recording time is shortened when a subject with fast movement is recorded.

[Continuous AF]

Applicable modes:          

It will continually keep on focusing on a subject for which the focus was once set.

Settings: [ON]/[OFF]

- Set this function to [OFF] if you wish to fix the focus on the position where you started the motion picture recording.
- The setting is fixed to [OFF] in the following case.
 - [Starry Sky] (Scene Mode)

Various methods of playback

You can play back the recorded pictures in various methods.

- 1 Press **[▶]**.
- 2 Press **[MODE]**.
- 3 Press **▲/▼/◀/▶** to select item, and then press **[MENU/SET]**.

• Following items can be selected.

[▶] ([All]) (P37)	[▶] ([Filtering Play]) (P101)
[▶] ([Slide Show]) (P99)	[▶] ([Calendar]) (P104)

[Slide Show]

You can play back the pictures you have taken in synchronisation with music, and you can do this in sequence while leaving a fixed interval between each of the pictures.

You can also play back images that have been sorted by category, images that have been set as favourites, etc. in a slide show.

This playback method is recommended when you have connected the camera to a TV set to view the pictures you have taken.

Press **▲/▼** to select **[Start]** and then press **[MENU/SET]**.

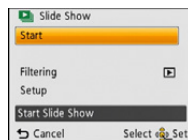

■ Operations performed during slide show

The cursor displayed during playback is the same as **▲/▼/◀/▶**.

	▲	Play/Pause		Reduce volume level
	▼	Stop		
	◀	Back to previous picture		
	▶	Ahead to next picture		

■ To filter images for slide show playback

You can filter images and play them back in a slide show by selecting [Filtering] on the slide show menu screen.

- If you select [All], you can play back all images in a slide show. You can also filter images by using the same setting as [Filtering Play]. Refer to P101–103 for the setting.
- The filter settings are stored even after terminating slide show playback. To cancel filtering, refer to P101.

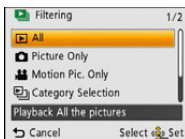

■ Changing the slide show settings

By selecting [Setup] on the slide show menu screen, you can change the settings such as [Effect] and [Duration] for slide show playback.

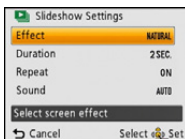

Settings	Description of settings
[Effect]	<p>This allows you to select the screen effects or music effects when switching from one picture to the next. [NATURAL], [SLOW], [SWING], [URBAN], [OFF]</p> <ul style="list-style-type: none"> • When [URBAN] has been selected, the picture may appear in black and white as a screen effect. • Some [Effect] will not operate when playing back pictures displayed vertically. • Even if [Effect] is set, it does not work during a slide show of Group Pictures. • [Effect] is locked to [OFF] when [Filtering] is set to the following: <ul style="list-style-type: none"> – [Motion Pic. Only] – [📷] in [Category Selection]
[Duration]	<p>[1SEC.]/[2SEC.]/[3SEC.]/[5SEC.]</p> <ul style="list-style-type: none"> • When playing back the following pictures, the [Duration] setting is disabled. <ul style="list-style-type: none"> – Motion pictures – Panorama pictures – Group of pictures taken in [Time Lapse Shot]
[Repeat]	[ON]/[OFF]
[Sound]	<p>[OFF]: There will be no sound.</p> <p>[AUTO]: Music is played when the still pictures are played back, and audio is played when the motion pictures are played back.</p> <p>[Music]: Music is played back.</p> <p>[Audio]: Audio (only for motion pictures) is played back.</p>

[Filtering Play]

The images sorted into the category or images set as favourite are played back.

Settings	Description of settings
[Picture Only]	Only still pictures are played back.
[Video Only]	Only motion pictures are played back.
[Category Selection]	This mode allows you to search images by Scene Mode or other categories (such as [Portrait], [Scenery] or [Night Scenery]) and sort the pictures into each of the categories. You can then play back the pictures in each category.
[Select Date]	You can play back pictures taken on each date.
[Favorite]	You can play back the pictures you have set as [Favorite] (P114).

■ To cancel filtering

- 1 Press **▲** while playing back one picture at a time.
- 2 Press **▲/▼** to select [Filtering Off] and then press [MENU/SET].
 - Filtering is also cancelled by turning off the camera or switching to Recording Mode.

Sorting by category to play back

- 1 Press ▲/▼ to select [Category Selection] and then press [MENU/SET].
- 2 Press ▲/▼/◀/▶ to select the category and then press [MENU/SET] to set.

- You can play back only the category in which an image has been found.

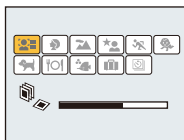

Category	Recording information e.g. Scene Modes
	[Face Recog.]*
	[Portrait], [i-Portrait], [Soft Skin], [Night Portrait], [i-Night Portrait], [Baby1]/[Baby2], [i-Baby]
	[Panorama Shot], [Scenery], [i-Scenery], [Sunset], [i-Sunset], [Glass Through]
	[Night Portrait], [i-Night Portrait], [Night Scenery], [i-Night Scenery], [Starry Sky]
	[Sports], [Snow], [Beach & Surf]
	[Baby1]/[Baby2], [i-Baby]
	[Pet]
	[Food]
	[Advanced Underwater]
	[Travel Date]
	[Time Lapse Shot], [Time Lapse Video]

- * Press ▲/▼/◀/▶ to select the person to play back and then press [MENU/SET]. The Group of pictures taken in [Time Lapse Shot] are treated as Face Recognition pictures in group units.

You can play back pictures taken on each date.

- 1** Press ▲/▼ to select [Select Date] and then press [MENU/SET].
- 2** Press ▲/▼/◀/▶ to select the date to be played back and then press [MENU/SET].

- If there were no pictures recorded during a month, that month is not displayed.

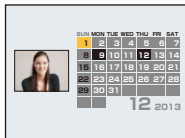

■ Changing the filtering date

- 1** Press ▲ while playing back one picture at a time.
- 2** Press ▲/▼ to select [Change Date] and then press [MENU/SET].
- 3** Press ▲/▼/◀/▶ to select the date to be played back and then press [MENU/SET].

- The recording date of the picture selected in the playback screen becomes the date selected when the calendar screen is first displayed.
- If there are multiple pictures with the same recording date, the first picture recorded on that day is displayed.
- You can display the calendar between January 2000 and December 2099.
- If the date is not set in the camera, the recording date is set as the 1st January, 2013.
- If you take pictures after setting the travel destination in [World Time], the pictures are displayed by the dates at the travel destination in Calendar Playback.

[Calendar]

You can search for images by recorded date.

1 Press ▲/▼/◀/▶ to select the date you want to search.

- If there were no pictures recorded during a month, that month is not displayed.

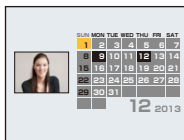

2 Press [MENU/SET] to display the list of images.

- Pictures are displayed with Multi Playback (30 screens). The cursor appears on the picture at the beginning of the selected date.

3 Press ▲/▼/◀/▶ to select a picture and then press [MENU/SET].

- To continue the search, return to the previous screen with [W] of the zoom button. (P38)

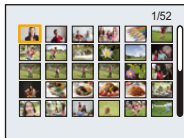

- The recording date of the picture selected in the playback screen becomes the date selected when the calendar screen is first displayed.
- If there are multiple pictures with the same recording date, the first picture recorded on that day is displayed.
- You can display the calendar between January 2000 and December 2099.
- If the date is not set in the camera, the recording date is set as the 1st January, 2013.
- If you take pictures after setting the travel destination in [World Time], the pictures are displayed by the dates at the travel destination in Calendar Playback.

Having Fun with Recorded Pictures (Retouch)

You can adjust the colour tone of the pictures taken, or add your preferred effects.

- The processed pictures are newly generated, so be sure that you have enough space in the built-in memory or on the card. Note also that processing will not be possible if the Write-Protect switch of the card is in the [LOCK] position.
- Effects may be difficult to see depending on the picture.
- Pictures taken with other cameras may not be processed.

[Auto Retouch]

The brightness and colour of the pictures taken can be balanced.

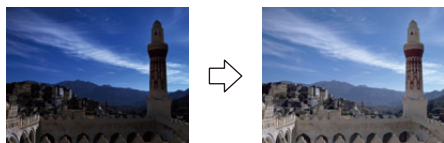

* These pictures are examples to show the effect.

1 Press ◀▶ to select a picture, and then press ▲.

- If you have filtered images for playback by using [Slide Show] (P99) or [Filtering Play] (P101), the selection screen appears. You can proceed to step 2 by selecting [Retouch] with ▲/▼, and then pressing [MENU/SET].
- You can also proceed to step 2 by selecting [Retouch] from the [Playback] menu.

2 Press ▲/▼ to select [Auto Retouch], and then press [MENU/SET].

3 Press ▲/▼ to select [ON], and then press [MENU/SET].

- If you select [OFF], an image with no effect is displayed. If you are not going to add an effect, exit the menu.
- Confirmation screen is displayed. It is executed when [Yes] is selected.

- Depending on the picture, noise may be emphasised by [Auto Retouch].
- It may not be possible to perform [Auto Retouch] on pictures which have already been retouched.
- The following pictures cannot be processed:
 - Motion pictures
 - Pictures taken in [Panorama Shot]
- Picture groups taken with [Time Lapse Shot] cannot be processed on a group-by-group basis.

[Creative Retouch]

You can add your desired effects to the pictures that you have taken.

1 Press ◀/▶ to select a picture, and then press ▲.

- If you have filtered images for playback by using [Slide Show] (P99) or [Filtering Play] (P101), the selection screen appears. You can proceed to step 2 by selecting [Retouch] with ▲/▼, and then pressing [MENU/SET].
- You can also proceed to step 2 by selecting [Retouch] from the [Playback] menu.

2 Press ▲/▼ to select [Creative Retouch], and then press [MENU/SET].

3 Press ▲/▼ to select image effects and then press [MENU/SET].

- You can select the item from the following options that are also available in the Creative Control mode.
[Expressive]/[Retro]/[High Key]/[Low Key]/[Sepia]/[Dynamic Monochrome]/[Impressive Art]/[High Dynamic]/[Cross Process]/[Toy Effect]/[Miniature Effect]/[One Point Color]
- A brief description of selected image effect appears when you press [DISP].
- Read P63–66 for details on the respective effects.
- To set the colour you want to keep by using [One Point Color], move the frame at the centre of the screen to the desired colour with ▲/▼/◀/▶, and then press [MENU/SET].
- If you select [OFF], an image with no effect is displayed. To proceed with the retouch operation, select another image effect. If you are not going to add any effect, exit the menu.
- Confirmation screen is displayed. It is executed when [Yes] is selected.



- The image effect may appear weak compared to the effect given by the Creative Control Mode.
- The following pictures cannot be processed:
 - Motion pictures
 - Pictures taken in [Panorama Shot]
- Picture groups taken with [Time Lapse Shot] cannot be processed on a group-by-group basis.

[Color Reproduction]

You can recreate the red tinge of the pictures taken underwater.

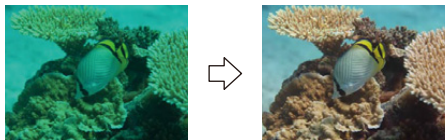

* These pictures are examples to show the effect.

1 Press ◀/▶ to select a picture, and then press ▲.

- If you have filtered images for playback by using [Slide Show] (P99) or [Filtering Play] (P101), the selection screen appears. You can proceed to step 2 by selecting [Retouch] with ▲/▼, and then pressing [MENU/SET].
- You can also proceed to step 2 by selecting [Retouch] from the [Playback] menu.

2 Press ▲/▼ to select [Color Reproduction], and then press [MENU/SET].

3 Press ▲/▼ to select the effect, and then press [MENU/SET].

- You can select from three levels of effect.
- If you select [OFF], an image with no effect is displayed. To proceed with the [Color Reproduction] operation, select another image effect. If you are not going to add any effect, exit the menu.
- Confirmation screen is displayed. It is executed when [Yes] is selected.

- The effect may be weaker than that of [Color Reproduction] in the [Rec] menu.
- The following pictures cannot be processed:
 - Motion pictures
 - Pictures taken in [Panorama Shot]
- Picture groups taken with [Time Lapse Shot] cannot be processed on a group-by-group basis.

Using the [Playback] Menu

You can perform actions like cropping recorded pictures, as well as set up the protection of recorded images, etc.

- With [Text Stamp], [Retouch], [Time Lapse Video], [Resize] or [Cropping] a new edited picture is created. A new picture cannot be created if there is no free space on the built-in memory or the card so we recommend checking that there is free space and then editing the picture.

[Text Stamp]

You can stamp the recording date/time, name, location or travel date onto the recorded pictures.

- 1 Select [Text Stamp] on the [Playback] menu.
- 2 Press ▲/▼ to select [SINGLE] or [MULTI] and then press [MENU/SET].

- 3 Select the picture, and then press [MENU/SET] to set.

- is displayed on pictures already with date or text stamped.

[MULTI] setting

Press [DISP.] to set (repeat), and then press [MENU/SET] to set.

- The setting is cancelled when [DISP.] is pressed again.

[SINGLE]



Press ◀/▶ to select the picture.

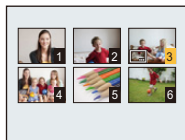

[MULTI]



Press ▲/▼/◀/▶ to select the pictures.

- 4 Press ▲/▼ to select [Set], and then press [MENU/SET].
- 5 Press ▲/▼ to select text stamp items, and then press [MENU/SET].

6 Press ▲/▼ to select the settings, and then press [MENU/SET].

Item	Setting item
[Shooting Date]	[W/O TIME]: Stamp the year, month and day. [WITH TIME]: Stamp the year, month, day, hour and minutes. [OFF]
[Name]	[]: ((Face Recognition)) Name registered in Face Recognition will be stamped. []: ((Baby/Pet)) Stamps names registered in name settings for [Baby1]/[Baby2] or [Pet] in Scene Mode. [OFF]
[Location]	[ON]: Stamps the travel destination name set under [Location]. [OFF]
[Travel Date]	[ON]: Stamps the travel date set under [Travel Date]. [OFF]

7 Press [/▶].

8 Press ▲ to select [OK], and then press [MENU/SET].

- Confirmation screen is displayed. It is executed when [Yes] is selected.
Exit the menu after it is executed.

- When you print pictures stamped with text, the date will be printed over the stamped text if you specify printing of the date at the photo shop or on the printer.
- You can set up to 100 pictures at one time in [MULTI].
- The picture quality may deteriorate when text stamping is carried out.
- Depending on the printer being used, some characters may be cut at printing. Check before printing.
- When text is stamped onto the 0.3M pictures, it is difficult to read it.
- When you stamp pictures in a group, the stamped ones are saved separately from the original ones in the group.
- Text and dates cannot be stamped on the pictures in the following cases.
 - Motion pictures
 - Pictures taken in [Panorama Shot]
 - Pictures recorded without setting the clock
 - Pictures with date or text stamped
 - Pictures recorded with other equipment

[Retouch]

You can add the effect of [Auto Retouch], [Creative Retouch], or [Color Reproduction] to recorded pictures.

- Refer to [P105–107](#) for details.

[Video Divide]

Recorded motion picture can be divided in two. It is recommended for when you want to divide a part you need with a part you do not need.

It cannot be restored once divided.

- 1 Select [Video Divide] on the [Playback] menu.**
- 2 Press ◀/▶ to select the motion picture to divide, and then press [MENU/SET].**
- 3 Press ▲ at the location to divide.**
 - Motion picture is played back from the same location when ▲ is pressed again.
 - You can finely adjust the location for division by pressing ◀/▶ while the motion picture is paused.
- 4 Press ▼.**
 - Confirmation screen is displayed. It is executed when [Yes] is selected. Exit the menu after it is executed.
 - Motion picture may be lost if the card or battery is removed while processing the dividing.



- [Video Divide] may not be performed on motion pictures recorded with other equipment.
- Motion pictures cannot be divided at a location close to the start or end of the motion picture.
- The order of images will change if motion pictures are divided.
It is recommended to search these motion pictures by using [Calendar] or [Video Only] in the [Filtering Play].
- Motion pictures with a short recording time cannot be divided.

[Time Lapse Video]

This function allows you to create a motion picture from a picture group recorded with [Time Lapse Shot]. The created motion picture is saved in MP4 recording format.

- 1 Select [Time Lapse Video] on the [Playback] menu.
- 2 Press ◀/▶ to select the picture group from which you want to create a motion picture, and then press [MENU/SET].
- 3 Press ▲/▼ to select the item and settings, and then press [MENU/SET].

Item	Settings	Setting item
[Rec Quality]	[HD]	Creates motion pictures in the pixel resolution of 1280×720 and aspect ratio of 16:9.
	[VGA]	Creates motion pictures in the pixel resolution of 640×480 and aspect ratio of 4:3.
[Frame Rate]	[5fps]	Plays back 5 images in 1 second.
	[25fps]	Plays back 25 images in 1 second.

- 4 Press ▲/▼ to select [Start], and then press [MENU/SET].

- Confirmation screen is displayed. It is executed when [Yes] is selected.
Exit the menu after it is executed.

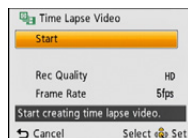

- When recording to the built-in memory, [Time Lapse Video] is not available.
- If you select the image quality in which the aspect ratio is different from the one for the picture group, black strips will appear on the top and bottom or left and right of the image.
- If a recorded image quality with a resolution higher than the group pictures have been selected, the image will become blurry.
- When creating motion pictures, we recommend you use the sufficiently-charged battery or the AC adaptor (optional).
- If power supply is lost by unplugging the AC adaptor or due to a blackout while creating a motion picture with the AC adaptor, the motion picture you are creating will not be recorded.
- The following motion pictures cannot be created:
 - A motion picture longer than 29 minutes and 59 seconds

[Resize]

To allow easy posting to web pages, attachment to email etc., picture size (number of pixels) is reduced.

- 1** Select **[Resize]** on the **[Playback]** menu.
- 2** Press **▲/▼** to select **[SINGLE]** or **[MULTI]** and then press **[MENU/SET]**.
- 3** Select the picture and size.

[SINGLE] setting

- 1** Press **◀/▶** to select the picture, and then press **[MENU/SET]**.
- 2** Press **◀/▶** to select the size, and then press **[MENU/SET]**.
 - Confirmation screen is displayed. It is executed when **[Yes]** is selected.
 - Exit the menu after it is executed.

**[MULTI] setting**

- 1** Press **▲/▼** to select the size, and then press **[MENU/SET]**.
- 2** Press **▲/▼/◀/▶** to select the picture, and then press **[DISP.]**.
 - Repeat this step for each picture, and press **[MENU/SET]** to set.
 - Confirmation screen is displayed. It is executed when **[Yes]** is selected.
 - Exit the menu after it is executed.

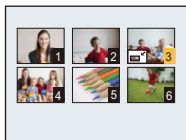

- You can set up to 100 pictures at one time in **[MULTI]**.
- The picture quality of the resized picture will deteriorate.
- It may not be possible to resize pictures recorded with other equipment.
- The following images cannot be resized.
 - Motion pictures
 - Pictures taken in **[Panorama Shot]**
 - Pictures with date or text stamped

[Cropping]

You can enlarge and then clip the important part of the recorded picture.

- 1** Select **[Cropping]** on the **[Playback]** menu.
- 2** Press **◀/▶** to select the picture, and then press **[MENU/SET]**.
- 3** Use the zoom button and press **▲/▼/◀/▶** to select the parts to be cropped.

W : Reduction

T : Enlargement

▲/▼/◀/▶ : Move

4 Press **[MENU/SET]**.

- Confirmation screen is displayed. It is executed when **[Yes]** is selected.
Exit the menu after it is executed.

- The picture quality of the cropped picture will deteriorate.
- Crop one picture at a time. (You cannot edit all pictures in a group at once)
- When you crop pictures in a group, the cropped ones are saved separately from the original ones in the group.
- It may not be possible to crop pictures recorded with other equipment.
- Information regarding the Face Recognition in the original picture will not be copied to images having undergone **[Cropping]**.
- The following images cannot be cropped.
 - Motion pictures
 - Pictures taken in **[Panorama Shot]**
 - Pictures with date or text stamped

[Favorite]

You can do the following if a mark has been added to pictures and they have been set as favourites.

- Play back only the pictures set as favourites. ([Favorite] in [Filtering Play])
- Play back the pictures set as favourites only as a Slide Show.
- Delete all the pictures not set as favourites. ([All Delete Except Favorite])

1 Select **[Favorite]** on the **[Playback]** menu.

2 Press **▲/▼** to select **[SINGLE]** or **[MULTI]** and then press **[MENU/SET]**.

3 Select the picture, and then press **[MENU/SET]**.

- The setting is cancelled when **[MENU/SET]** is pressed again.
- Exit the menu after it is set.

[SINGLE]



Press **◀/▶** to select the picture.

[MULTI]

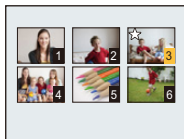

Press **▲/▼/◀/▶** to select the pictures.

■ Cancelling all the [Favorite] settings

1 Select **[Favorite]** on the **[Playback]** menu.

2 Press **▲/▼** to select **[CANCEL]** and then press **[MENU/SET]**.

- Confirmation screen is displayed. It is executed when **[Yes]** is selected. Exit the menu after it is executed.

- You can set up to 999 pictures as favourites.
- You may not be able to set pictures taken with other equipment as favourites.

[Print Set]

DPOF "Digital Print Order Format" is a system that allows the user to select which pictures to print, how many copies of each picture to print and whether or not to print the recording date on the pictures when using a DPOF compatible photo printer or photo printing store. For details, ask at your photo printing store.

When you want to use a photo printing store to print pictures recorded on the built-in memory, copy them to a card (P119) and then set the print setting.

When you set [Print Set] for a group pictures, the print setting for the number of prints will be applied to every picture in the group.

- 1 Select [Print Set] on the [Playback] menu.
- 2 Press ▲/▼ to select [SINGLE] or [MULTI] and then press [MENU/SET].

- 3 Select the picture, and then press [MENU/SET].

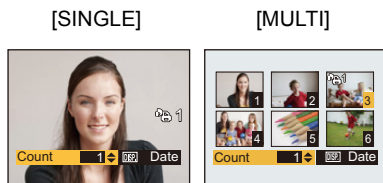

Press ◀/▶ to select the picture.

Press ▲/▼/◀/▶ to select the pictures.

- 4 Press ▲/▼ to set the number of prints, and then press [MENU/SET] to set.

- When [MULTI] has been selected, repeat steps 3 and 4 for each picture. (It is not possible to use the same setting for a multiple number of pictures.)
- Exit the menu after it is set.

■ Cancelling all the [Print Set] settings**1** Select [Print Set] on the [Playback] menu.**2** Press ▲/▼ to select [CANCEL] and then press [MENU/SET].

- Confirmation screen is displayed. It is executed when [Yes] is selected.
Exit the menu after it is executed.

■ To print the date

After setting the number of prints, set/cancel printing with the recording date by pressing [DISP].

- Depending on the photo printing store or the printer, the date may not be printed even if you set to print the date. For further information, ask at your photo printing store or refer to the operating instructions for the printer.
- The date cannot be printed on pictures with date or text stamped.

- The number of prints can be set from 0 to 999.
- Depending on the printer, the date print settings of the printer may take precedence so check if this is the case.
- It may not be possible to use the print settings with other equipment. In this case, cancel all the settings, and reset the settings.
- You cannot use [Print Set] for the following pictures.
 - Motion pictures
 - File that does not comply with the DCF standard

[Protect]

You can set protection for pictures you do not want to be deleted by mistake.

- 1** Select **[Protect]** on the **[Playback]** menu.
- 2** Press **▲/▼** to select **[SINGLE]** or **[MULTI]** and then press **[MENU/SET]**.
- 3** Select the picture, and then press **[MENU/SET]**.

- The settings are cancelled when **[MENU/SET]** is pressed again.
- Exit the menu after it is set.

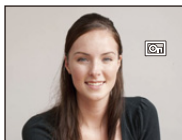
[SINGLE]

Press **◀/▶** to
select the picture.

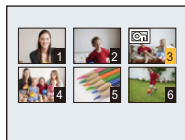
[MULTI]

Press **▲/▼/◀/▶** to
select the pictures.

■ Cancelling all the **[Protect]** settings

- 1** Select **[Protect]** on the **[Playback]** menu.
- 2** Press **▲/▼** to select **[CANCEL]** and then press **[MENU/SET]**.
 - Confirmation screen is displayed. It is executed when **[Yes]** is selected.
Exit the menu after it is executed.

- The protect setting may not be effective on other equipment.
- Even if you protect pictures in the built-in memory or a card, they will be deleted if the built-in memory or the card is formatted.
- Even if you do not protect pictures on a card, they cannot be deleted when the card's Write-Protect switch is set to **[LOCK]**.

[Face Rec Edit]

You can delete or change the information relating to Face Recognition for the selected picture.

- 1** Select **[Face Rec Edit]** on the **[Playback]** menu.
- 2** Press **▲/▼** to select **[REPLACE]** or **[DELETE]** and then press **[MENU/SET]**.
- 3** Press **◀/▶** to select the picture and then press **[MENU/SET]**.
- 4** Press **◀/▶** to select the person and then press **[MENU/SET]**.
- 5** (When **[REPLACE]** is selected) Press **▲/▼/◀/▶** to select the person to replace and then press **[MENU/SET]**.

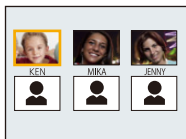

- Confirmation screen is displayed. It is executed when [Yes] is selected.
Exit the menu after it is executed.

- Cleared information regarding the [Face Recog.] cannot be restored.
- When all Face Recognition information in a picture has been cancelled, the picture will not be categorised using Face Recognition in [Category Selection] in [Filtering Play].
- You cannot edit the Face Recognition information of protected pictures.

[Copy]

You can copy the data of the pictures you have taken from the built-in memory to a card or from a card to the built-in memory.

- 1 Select [Copy] on the [Playback] menu.**
- 2 Press ▲/▼ to select the copy destination and then press [MENU/SET].**

[IN→SD] ((IN→SD)): All the picture data in the built-in memory are copied onto the card at one time.

[SD→IN] ((SD→IN)): One picture at a time is copied from the card to the built-in memory. Press ◀/▶ to select the picture and then press [MENU/SET].

- Confirmation screen is displayed. It is executed when [Yes] is selected. Exit the menu after it is executed.
 - Do not turn the camera off at any point during the copying process.
- If a picture exists with the same name (folder number/file number) as the picture to be copied in the copy destination when **[IN→SD]** is selected, a new folder is created and the picture is copied. If a picture exists with the same name (folder number/file number) as the picture to be copied in the copy destination when **[SD→IN]** is selected, that picture is not copied.
- It may take time to copy the picture data.
 - [Print Set], [Protect] or [Favorite] settings will not be copied. Perform the settings again after copying is finished.

Playing Back Pictures on a TV Screen

Pictures recorded with this unit can be played back on a TV screen.

Preparations:

Set the [TV Aspect]. (P49)

Turn this unit and the TV off.

1 Connect the camera and a TV.

- Check the directions of the connectors, and plug them straight in or unplug them straight out. (Otherwise the connectors may be bend of shape, which will cause a malfunction.)
- Always use a genuine Panasonic AV cable (DMW-AVC1: optional).

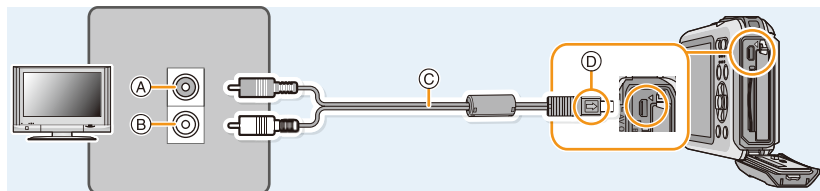

(A) Yellow: to the video input socket

(B) White: to the audio input socket

(C) AV cable (optional)

(D) Align the marks, and insert.

2 Turn the TV on and select external input.

3 Turn the camera on and then press [▶].

- Depending on the [Picture Size], black bands may be displayed on the top and bottom or the left and right of the pictures.
- Change the screen mode on your TV if the picture is displayed with the top or bottom cut off.
- When you play back a picture vertically, it may be blurry.
- When pictures are displayed, they may not be displayed properly depending on the type of TV.
- You can view pictures on TVs in other countries (regions) which use the NTSC or PAL system when you set [Video Out] in the [Setup] menu.
- No sound is output from the camera speakers.
- Read the operating instructions for the TV.
- Before removing a battery, turn the camera off and disconnect the AV cable.

The recorded still pictures can be played back on a TV with an SD Memory Card slot.

- Depending on the TV model, pictures may not be displayed on the full screen.
- Motion pictures may not be played back depending on the TV type.
- In some cases, panorama pictures cannot be played back. Also, auto-scroll playback of panorama pictures may not work.
- For cards compatible with playback, refer to the operating instructions of the TV.

Saving still pictures and motion pictures on your PC

You can transfer the pictures in the camera to a PC by connecting the camera and the PC.

- Some PCs can read directly from the card removed from the camera. For details, refer to the operating instructions of your PC.
- **If the computer being used does not support SDXC Memory Cards, a message prompting you to format may appear. (Doing so will cause recorded images to be erased so do not choose to format.)**

If the card is not recognised, please refer to the below support site.

<http://panasonic.net/avc/sdcard/information/SDXC.html>

■ PC that can be used

The unit can be connected to any PC capable of recognising a mass storage device.

- Windows support: Windows 8/Windows 7/Windows Vista/Windows XP
- Mac support: OS X v10.1 ~ v10.8

About the supplied software

The supplied CD-ROM includes the following software.

Install the software on to your computer before use.

• PHOTOfunSTUDIO 9.0 SE (Windows 8/7/Vista/XP)

This software allows you to manage images. For example, you can send pictures and motion pictures to a PC and sort them by recording date or model name. You can also perform operations such as writing images to a DVD, processing and correcting images, and editing motion pictures.

• LoiLoScope 30 day full trial version (Windows 8/7/Vista/XP)

LoiLoScope is a video editing software where that draws out the full power of your PC. Creating videos is as easy as organizing cards on top of a desk. Use your music, picture and video files to create videos to share with your friends and family by burning it to a DVD, uploading it to websites, or simply share your videos with your friends via e-mail.

– This will only install a shortcut to the trial version download site.

For more information on how to use LoiLoScope, read the LoiLoScope manual available for download at the link below.

Manual URL: <http://loilo.tv/product/20>

■ Installing supplied software

- Before inserting the CD-ROM, close all running applications.

1 Check the environment of your PC.

- **Operating environment of “PHOTOfunSTUDIO 9.0 SE”**

– OS:

Windows® XP (32bit) SP3,
Windows Vista® (32bit) SP2,
Windows® 7 (32bit/64bit) or SP1
Windows® 8 (32bit/64bit)

– CPU:

Pentium® III 500 MHz or higher (Windows® XP),
Pentium® III 800 MHz or higher (Windows Vista®),
Pentium® III 1 GHz or higher (Windows® 7/Windows® 8)

– Display:

1024×768 pixels or more (1920×1080 pixels or more recommended)

– RAM:

512 MB or more (Windows® XP/Windows Vista®),
1 GB or more (Windows® 7 32bit/Windows® 8 32bit),
2 GB or more (Windows® 7 64bit/Windows® 8 64bit)

– Free hard disk space:

450 MB or more for installing software

- Refer to the operating instructions of “PHOTOfunSTUDIO” (PDF) for further operating environment.

2 Insert the CD-ROM with the supplied software.

- When you insert the supplied CD-ROM, the install menu will start.

3 Click on the [Applications] on the install menu.

4 Click on the [Recommended Installation].

- Proceed with installation according to messages appearing on the screen.

- The software compatible with your PC will be installed.
- “PHOTOfunSTUDIO” and “LoiLoScope” are not compatible with Mac.

■ Transferring pictures to a PC

Preparations: Install “PHOTOfunSTUDIO” to the PC.

1 Connect the computer and camera with the USB connection cable (supplied).

- Please turn this unit on and your PC before connecting.
- Check the directions of the connectors, and plug them straight in or unplug them straight out. (Otherwise the connectors may be bend of shape, which will cause a malfunction.)
- Do not use any other USB connection cables except the supplied one or a genuine Panasonic USB connection cable (DMW-USBC1: optional).

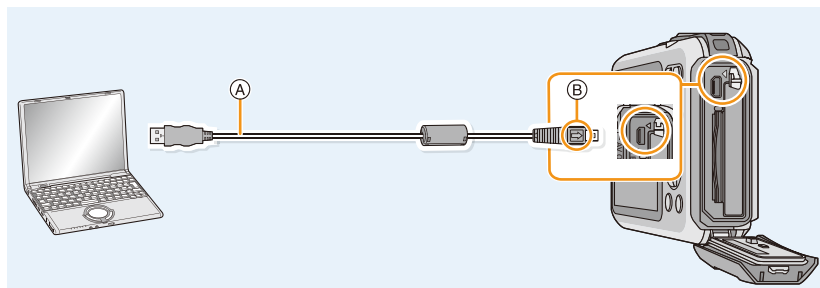

Ⓐ USB connection cable (supplied)

Ⓑ Align the marks, and insert.

2 Press ▲/▼ to select [PC], and then press [MENU/SET].

3 Copy the images to a PC using “PHOTOfunSTUDIO”.

- Do not delete or move copied files or folders in Windows Explorer. When viewing in “PHOTOfunSTUDIO”, you will not be able to play back or edit.

• Use a battery with sufficient battery power or the AC adaptor (optional). If the remaining battery power becomes low while the camera and the PC are communicating, the status indicator blinks and the alarm beeps.

Refer to “Disconnecting the USB connection cable safely” (P125) before disconnecting the USB connection cable. Otherwise, data may be destroyed.

- Before connecting or disconnecting the AC adaptor (optional), turn the camera off.
- Before inserting or removing a card, turn the camera off and disconnect the USB connection cable. Otherwise, data may be destroyed.

■ Copying to a PC without using “PHOTOfunSTUDIO”

If the installation of “PHOTOfunSTUDIO” fails, you can copy files and folders to your PC by dragging and dropping them from the camera after connecting to your PC.

Directory structure of built-in memory/card of this unit is shown by the figure below.

For Windows: A drive ([Removable Disk]) is displayed in [Computer]

For Mac: A drive ([NO_NAME]) is displayed on the desktop

- Built-in Memory
- Card

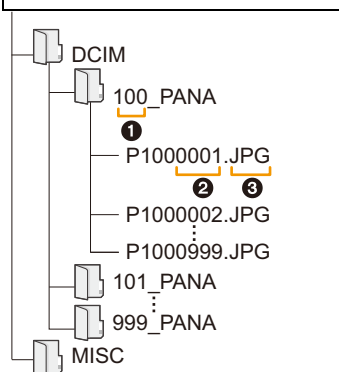

DCIM:

① Folder number

② File number

③ JPG:

MP4:

MISC:

Images

Still pictures

MP4 Motion pictures

DPOF print

Favourite

• A new folder is created when pictures are taken in the following situations.

- After [No.Reset] (P48) in the [Setup] menu has been executed
- When a card containing a folder with the same folder number has been inserted (such as when pictures were taken using another maker of camera)
- When there is a picture with file number 999 inside the folder

■ Disconnecting the USB connection cable safely

Select the [🔌] icon in the task tray displayed on the PC, and then click [Eject DMC-XXX] (XXX varies by model).

- Depending on your PC's settings, this icon may not be displayed.
- If the icon is not displayed, check that [Access] is not displayed on the LCD monitor of the digital camera before removing the hardware.

■ Connection in the PTP Mode

Select [PictBridge(PTP)] when connecting USB connection cable.

- Data can now be read only from the card into the PC.
- When there are 1000 or more pictures on a card, the pictures may not be imported in the PTP Mode.
- Motion picture cannot be played back in PTP Mode.

Saving still pictures and motion pictures on a Recorder

If you insert card holding content recorded with this unit into a Panasonic recorder, you can dub the content to a Blu-ray Disc or DVD etc.

Copy by inserting the SD card into the recorder

For details on Panasonic devices compatible with the respective file format (such as a Blu-ray Disc recorder), refer to the support sites below.

For details on compatible devices, refer to the support sites below.

<http://panasonic.jp/support/global/cs/dsc/>

(This Site is English only.)

* Some compatible devices may not be sold in certain countries and regions.

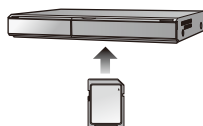

• See the operating instructions for the recorder about the details about copying and playing back.

■ Dubbing with non-compatible equipment

You can dub the content played back using this unit to non-compatible equipment such as recorders and video players by connecting this unit to the non-compatible equipment using an AV cable (optional). Non-compatible equipment will be able to play back the content. This is convenient if you wish to pass around dubbed content. In this case, the content will be played back in standard rather than high-definition picture quality.

- 1 Connect this unit with the recording equipment with an AV cable (optional).
- 2 Start the playback of this unit.
- 3 Start the recording on the recording equipment.

- When ending the recording (copying), stop the playback on this unit after stopping the recording of the recording equipment.

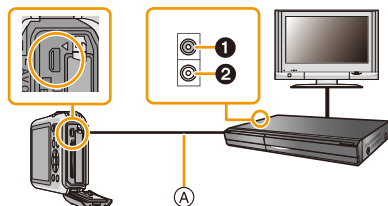

- 1 Yellow: to the video input socket
- 2 White: to the audio input socket
- (A) AV cable (optional)

• When you play back motion pictures on 4:3 aspect ratio TV, you must set [TV Aspect] (P49) on this unit to [4:3] before starting a copy. The image will be vertically long if you play back motion pictures copied with [16:9] setting on a [4:3] aspect TV.

• See the operating instructions for the recording equipment regarding the details of copying and playing back.

Printing the Pictures

If you connect the camera to a printer supporting PictBridge, you can select the pictures to be printed out and instruct that printing be started on the camera's LCD monitor.

- Some printers can print directly from the card removed from the camera. For details, refer to the operating instructions of your printer.

Preparations:

Turn on the camera and the printer.

Remove the card before printing the pictures from the built-in memory.

Check print quality and other settings on the printer before printing the pictures.

1 Connect the printer and camera with the USB connection cable (supplied).

- Check the directions of the connectors, and plug them straight in or unplug them straight out. (Otherwise the connectors may be bent out of shape which will cause a malfunction.)
- Do not use any other USB connection cables except the supplied one or a genuine Panasonic USB connection cable (DMW-USBC1: optional).

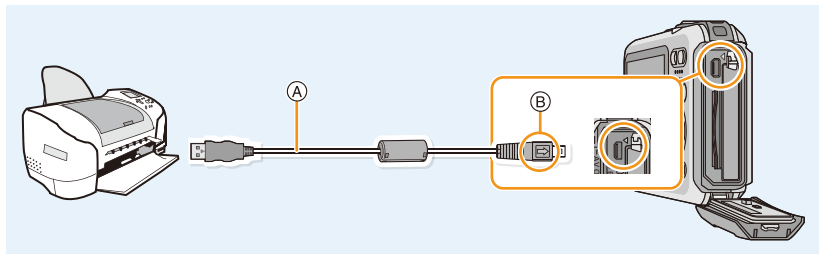

(A) USB connection cable (supplied)

(B) Align the marks, and insert.

2 Press **▲/▼** to select [PictBridge(PTP)], and then press [MENU/SET].

- Use a battery with sufficient battery power or the AC adaptor (optional). If the remaining battery power becomes low while the camera and the printer are connected, the status indicator blinks and the alarm beeps. If this happens during printing, stop printing at once. If not printing, disconnect the USB connection cable.
- Do not disconnect the USB connection cable while [🚫] (Cable disconnect prohibit icon) is displayed. (may not be displayed depending on the type of printer used)
- Before connecting or disconnecting the AC adaptor (optional), turn the camera off.
- Before inserting or removing a card/battery, turn the camera off, and disconnect the USB connection cable.
- Motion pictures cannot be printed out.

Selecting a single picture and printing it

1 Press **◀/▶** to select the picture and then press **[MENU/SET]**.



2 Press **▲** to select **[Print start]** and then press **[MENU/SET]**.

- Refer to [P129](#) for the items which can be set before starting to print the pictures.
- Disconnect the USB connection cable after printing.

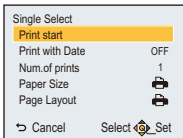

Selecting multiple pictures and printing them

1 Press **▲**.

2 Press **▲/▼** to select an item and then press **[MENU/SET]**.

Item	Description of settings
[Multi Select]	Multiple pictures are printed at one time. • Press ▲/▼/◀/▶ to select the pictures, and then press [DISP.] . (When [DISP.] is pressed again, the setting is cancelled.) • After the pictures have been selected, press [MENU/SET] .
[Select All]	Prints all the stored pictures.
[Print Set (DPOF)]	Prints the pictures set in [Print Set] only. (P115)
[Favorite]	Prints the pictures set as favourites only. (P114)

3 Press **▲** to select **[Print start]** and then press **[MENU/SET]**.

- If the print check screen has appeared, select **[Yes]**, and print the pictures.
- Refer to [P129](#) for the items which can be set before starting to print the pictures.
- Disconnect the USB connection cable after printing.

Print Settings

Select and set the items both on the screen in step 2 of the “Selecting a single picture and printing it” and in step 3 of the “Selecting multiple pictures and printing them” procedures.

- When you want to print pictures in a paper size or a layout which is not supported by the camera, set [Paper Size] or [Page Layout] to  and then set the paper size or the layout on the printer. (For details, refer to the operating instructions of the printer.)
- When [Print Set (DPOF)] has been selected, the [Print with Date] and [Num.of prints] items are not displayed.

[Print with Date]

Item	Description of settings
[ON]	Date is printed.
[OFF]	Date is not printed.

- If the printer does not support date printing, the date cannot be printed on the picture.
- Depending on the printer, the date print settings of the printer may take precedence so check if this is the case.
- When printing images with [Date Stamp] or [Text Stamp], please remember to set [Print with Date] to [OFF] or the date will print on top.

When asking the photo shop to print the pictures

- By stamping the date using [Date Stamp] (P97) or [Text Stamp] (P108) or setting date printing at the time of the [Print Set] (P115) setting before going to a photo shop, the dates can be printed at the photo shop.

[Num.of prints]





You can set the number of prints up to 999.

[Paper Size]

Item	Description of settings
	Settings on the printer are prioritised.
[L/3.5"×5"]	89 mm×127 mm
[2L/5"×7"]	127 mm×178 mm
[POSTCARD]	100 mm×148 mm
[16:9]	101.6 mm×180.6 mm
[A4]	210 mm×297 mm
[A3]	297 mm×420 mm
[10×15cm]	100 mm×150 mm
[4"×6"]	101.6 mm×152.4 mm
[8"×10"]	203.2 mm×254 mm
[LETTER]	216 mm×279.4 mm
[CARD SIZE]	54 mm×85.6 mm

• Paper sizes not supported by the printer will not be displayed.

[Page Layout] (Layouts for printing that can be set with this unit)

Item	Description of settings
	Settings on the printer are prioritised.
	1 picture with no frame on 1 page
	1 picture with a frame on 1 page
	2 pictures on 1 page
	4 pictures on 1 page

- An item cannot be selected if the printer does not support the page layout.

■ Layout printing**When printing a picture several times on 1 sheet of paper**

For example, if you want to print the same picture 4 times on 1 sheet of paper, set [Page Layout] to  and then set [Num.of prints] to 4 for the picture that you want to print.

When printing different pictures on 1 sheet of paper

For example, if you want to print 4 different pictures on 1 sheet of paper, set [Page Layout] to  and then set [Num.of prints] to 1 for each of the 4 pictures.

- The camera is receiving an error message from the printer when the  indication lights orange during printing. After finishing printing, make sure there are no problems with the printer.
- If the number of prints is high, the pictures may be printed several times. In this case, the remaining number of prints indicated may differ from the number set.

Screen Display

In recording

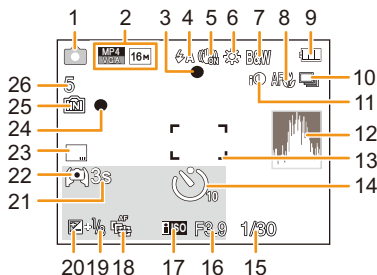

- 1 Recording Mode
- 2 Recording Quality (P98)
Picture Size (P78)
: Backlight Compensation (P30)
- 3 Focus (P33)
- 4 Flash Mode (P54)
: LED light (P47)
- 5 Optical Image Stabiliser (P96)
: Jitter alert (P27)
- 6 White Balance (P80)
- 7 Colour Mode (P95)
: Creative control adjustment display (P62)
- 8 AF Macro Mode (P58)
: Macro Zoom Mode (P58)
- 9 Battery indication (P17)
- 10 Burst (P90)
: Auto Bracket (P61)
- 11 Intelligent Exposure (P89)
- 12 Histogram (P46)
- 13 AF area (P33)
: Spot AF area (P82)
- 14 Self-timer Mode (P59)
: Time Lapse Shot (P92)
- 15 Shutter speed (P32)
- 16 Aperture value (P32)
- 17 ISO sensitivity (P79)
- 18 Number of days that have passed since the departure date (P43)
Location (P43)
Name (P75)
Age (P75)
Current date and time
: World Time (P42)
Zoom (P52):
- 19 AF Tracking (P84)
AF*: AF assist lamp (P95)
- 20 Exposure compensation (P60)
- 21 Elapsed recording time (P35): 8m30s*
- 22 Monitor Luminance (P45)
- 23 Date Stamp (P97)
- 24 Recording state (P35)
- 25 Built-in memory (P22)
: Card (P22) (displayed only during recording)
- 26 Number of recordable pictures (P24)
Available recording time (P24, 35): R8m30s*

* "m" is an abbreviation for minute and "s" for second.

■ In playback

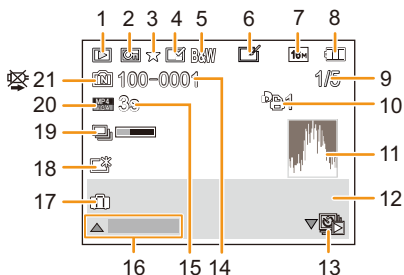

- | | |
|--|--|
| <p>1 Playback Mode (P99)</p> <p>2 Protected picture (P117)</p> <p>3 Favourites (P114)</p> <p>4 Date/Text stamped display (P97, 108)</p> <p>5 Colour Mode (P95)</p> <p>6 After Auto Retouch (P105)
After Creative Retouch (P106)
After Underwater Colour Reproduction (P107)</p> <p>7 Picture Size (P78)</p> <p>8 Battery indication (P17)</p> <p>9 Picture number</p> <p>10 Total pictures</p> <p>11 Elapsed playback time (P37): 8m30s*</p> <p>12 Number of prints (P115)</p> <p>13 Histogram (P46)</p> <p>14 Location (P43)
Recording information
Name (P75)
Age (P75)</p> <p>15 Single playback of a picture taken with [Time Lapse Shot] (P94)</p> | <p>16 Folder/File number (P125)</p> <p>17 Motion picture recording time (P37): 8m30s*</p> <p>18 Auto Retouch (P105)
Creative Retouch (P106)
Underwater Colour Reproduction (P107)
Motion picture playback (P37)
Play panorama (P71)
Sequential playback in the group of the pictures taken in [Time Lapse Shot] (P94)
Filtering cancel (P101)</p> <p>19 Number of days that have passed since the departure date (P43)
Recorded date and time
✈: World Time (P42)</p> <p>20 Power Monitor (P45)</p> <p>21 Currently retrieving information icon (P144)</p> <p>22 Recording Quality (P98)
📷: Group of pictures taken in [Time Lapse Shot] (P94)</p> <p>23 Built-in memory (P22)
Cable disconnection prohibiting icon (P127)</p> |
|--|--|

* "m" is an abbreviation for minute and "s" for second.

Cautions for Use

(Important) About the waterproof/dustproof and anti-shock performance of the camera

- This camera has a waterproof/dustproof function equivalent to "IP68". It is possible to take pictures in 7 m (23 feet) depth for 60 minutes.*
(This means that the camera can be used underwater for specified time in specified pressure in accordance with the handling method established by Panasonic.)
- The camera has cleared a drop test from a height of 1.5 m (5 feet) onto 3 cm (0.1 feet) thick plywood, which is compliant with "MIL-STD 810F Method 516.5-Shock".*
 - * This does not guarantee no destruction, no malfunction, or waterproofing in all conditions.
- Waterproofing is not guaranteed if the unit is subject to an impact as a result of being hit or dropped etc. If an impact to the camera occurs, it should be inspected (subject to a fee) by Panasonic to verify that the waterproofing is still effective.
- Using the camera in environments where splashing with hot spring water, oil or alcohol is likely to occur may cause the water/dust resistance and impact resistance of the camera to deteriorate.
- Malfunction caused by exposure to water due to mishandling by the customer will not be covered by the warranty.
- Supplied accessories are not waterproof.

For more detail, refer to "(Important) About the Waterproof/Dustproof and Anti-shock Performance of the Camera" (P8).

When using in a cold climate or at low temperatures

- **It may cause injury to the skin if you directly touch the metal parts of the unit in places where temperature is very low [environments under 0 °C (32 °F), such as ski resorts or places at high altitude] for a long period of time.**
Use gloves or similar when using it for long periods.
- The performance of the battery (number of recordable pictures/operating time) may decrease temporarily when using in a temperature between -10 °C and 0 °C (14 °F and 32 °F) (cold places such as ski resorts or places at high altitude).
- The battery cannot be recharged in a temperature less than 0 °C (32 °F). (The [CHARGE] indicator blinks when the battery cannot be recharged.)
- If the camera gets very cold in cold places such as ski resorts or places at high altitude, performance of the LCD monitor may temporarily drop immediately after turning this unit on, e.g. the picture on the LCD monitor being slightly darker than usual or ghost images appearing. In cold environments, keep the camera warm during use by keeping it inside your cold-weather gear or clothes. The performance will resume as normal when the internal temperature rises.
- If the camera is used in cold places such as ski resorts or places at high altitude with snow or water droplets adhered to the camera, some parts of the camera may become hard to move or the sound may become dim with snow or water droplets freezing in the gap of the zoom button, the camera [ON/OFF] button, speakers, and microphone. This is not a malfunction.

Optimal use of the camera

Keep this unit as far away as possible from electromagnetic equipment (such as microwave ovens, TVs, video games etc.).

- If you use this unit on top of or near a TV, the pictures and/or sound on this unit may be disrupted by electromagnetic wave radiation.
- Do not use this unit near cell phones because doing so may result in noise adversely affecting the pictures and/or sound.
- Recorded data may be damaged, or pictures may be distorted, by strong magnetic fields created by speakers or large motors.
- Electromagnetic wave radiation generated by microprocessors may adversely affect this unit, disturbing the pictures and/or sound.
- If this unit is adversely affected by electromagnetic equipment and stops functioning properly, turn this unit off and remove the battery or disconnect AC adaptor (optional). Then reinsert the battery or reconnect AC adaptor and turn this unit on.

Do not use this unit near radio transmitters or high-voltage lines.

- If you record near radio transmitters or high-voltage lines, the recorded pictures and/or sound may be adversely affected.

Always use the supplied cords and cables. If you use optional accessories, use the cords and the cables supplied with them.

Do not extend the cords or the cables.

Do not spray the camera with insecticides or volatile chemicals.

- If the camera is sprayed with such chemicals, the body of the camera may be damaged and the surface finish may peel off.
- Do not keep rubber or plastic products in contact with the camera for a long period of time.

The speaker does not have magnetic shielding. Do not keep this speaker and magnetised cards (bank cards, commuter passes, etc.) close together.

Operation of this unit is tested up to -10°C (14°F), but be aware that some parts of the camera may become hard to move when the zoom button or the camera [ON/OFF] button gets frozen etc., or the side door may become hard to open in cold places such as ski resorts or places at high altitude where the temperature may drop very rapidly.

- When the camera is used in a cold places such as ski resorts or places at high altitude, keep the camera warm by placing it in a warm place such as inside your cold protection gear or clothing.

Cleaning

Before cleaning the camera, remove the battery or the DC coupler (optional), or disconnect the power plug from the outlet. Then wipe the camera with a dry, soft cloth.

- When the camera is soiled badly, it can be cleaned by wiping the dirt off with a wrung wet cloth, and then with a dry cloth.
- Do not use solvents such as benzine, thinner, alcohol, cleanser, kitchen detergents, etc., to clean the camera, since it may deteriorate the external case or the coating may peel off.
- When using a chemical cloth, be sure to follow the accompanying instructions.
- When salt etc., has adhered to the camera, the arm part of the side door etc., may whiten. Use damp cotton swabs or similar to wipe until the whitened part is removed.

Ⓐ Arm part

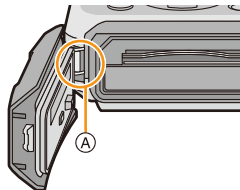

About the LCD monitor

- Do not press the LCD monitor with excessive force. Uneven colours may appear on the LCD monitor and it may malfunction.
- If the camera gets very cold in cold places such as ski resorts or places at high altitude, performance of the LCD monitor may temporarily drop immediately after turning this unit on, e.g. the picture on the LCD monitor being slightly darker than usual or ghost images appearing. Keep the camera warm when using in a cold environment. The performance will resume as normal when the internal temperature rises.

Extremely high precision technology is employed to produce the LCD monitor screen. However, there may be some dark or bright spots (red, blue, or green) on the screen. This is not a malfunction. The LCD monitor screen has more than 99.99% effective pixels with a mere 0.01% of the pixels inactive or always lit. The spots will not be recorded on pictures on the built-in memory or a card.

About the lens, the microphone, and the speaker

- Do not press the lens with excessive force.
- Do not leave the camera with the lens facing the sun, as rays of light from the sun may cause it to malfunction. Also, be careful when placing the camera outside or near a window.
- If there is water or dirt on the lens, wipe it off with dry soft cloth before taking a picture.
- A sound might be muffled or warped when there is water on the microphone or the speaker. Wipe the residues after letting the water drip out from the microphone and speaker by tipping the camera downward, and use it after letting it dry for a while.
- Do not poke the holes of microphone and speaker with sharp points. (It may damage the waterproof sheet inside, which may damage the waterproof performance.)

Battery

The battery is a rechargeable lithium ion battery. Its ability to generate power comes from the chemical reaction that takes place inside it. This reaction is susceptible to the surrounding temperature and humidity. If the temperature is too high or too low, the operating time of the battery will become shorter.

Always remove the battery after use.

- Place the removed battery in a plastic bag, and store or carry away from metallic objects (clips, etc.).

If you drop the battery accidentally, check to see if the body of the battery and the terminals are damaged.

- Inserting a damaged battery in the camera will damage the camera.

Bring charged spare batteries when going out.

- Be aware that the operating time of the battery becomes shorter in cold places such as ski resorts or places at high altitude.
- When you travel, do not forget to bring the battery charger (supplied) so that you can charge the battery in the country that you are travelling in.

Dispose of unusable battery.

- The battery has a limited life.
- Do not throw the battery into fire because it may cause an explosion.

Do not allow battery terminals to come into contact with metal objects (such as necklaces, hairpins, etc.).

- This can cause short-circuiting or heat generation and you may be badly burned if you touch a battery.

Charger

- The [CHARGE] indicator may blink under the influence of static electricity or electromagnetic wave. This phenomenon have no effects on charging.
- If you use the battery charger near a radio, the radio reception may be disturbed.
- Keep the charger 1 m (3.3 feet) or further away from radios.
- The charger may generate whirring sounds when it is being used. This is not a malfunction.
- After use, be sure to disconnect the power supply device from the electrical outlet. (A very small amount of current is consumed if it is left connected.)
- Keep the terminals of the charger and battery clean.

Card

Do not leave the card where the temperature is high, where electromagnetic waves or static electricity are easily generated or exposed to direct sunlight.

Do not bend or drop the card.

- The card may be damaged or the recorded content may be damaged or deleted.
- Put the card in the card case or the storage bag after use and when storing or carrying the card.
- Do not allow dirt, dust, or water to get into the terminals on the back of the card and do not touch the terminals with your fingers.

Notice for when transferring to another party, or disposing of the memory card

- "Format" or "delete" using the camera or a PC will only modify the file management information, it will not erase the data in the memory card completely.

It is recommended to physically destroy the memory card or use the commercially available computer data deletion software to completely erase the data in the memory card before transferring to another party or disposing.

Management of data in the memory card is the responsibility of the user.

About the personal information

If a name or birthday is set for [Baby1]/[Baby2]/Face Recognition function, this personal information is kept in the camera and recorded in the image.

Disclaimer

- Information including personal information may be altered or vanish due to erroneous operation, effect of static electricity, accident, malfunction, repair, or other handlings.
Please note in advance that Panasonic is not liable in any way for any direct or indirect damage from the alteration or vanishing of information or personal information.

When requesting a repair, transferring to another party, or disposing

- Reset the settings to protect the personal information. (P48)
- If there are pictures stored in the built-in memory, copy them onto the memory card (P119) before formatting the built-in memory (P50) as needed.
- Remove the memory card from the camera when requesting a repair.
- Built-in memory and settings may return to factory default when camera is repaired.
- Please contact the dealer where you purchased the camera or Panasonic if above operations are not possible due to malfunction.

When transferring to another party, or disposing of the memory card, please refer to “Notice for when transferring to another party, or disposing of the memory card” on P139.

When uploading images on WEB services

- Images may contain information that can be used for identifying individuals such as titles, recording dates, and location information. When uploading images on WEB services, check carefully, and then upload.

When not using the camera for a long period of time

- Store the battery in a cool and dry place with a relatively stable temperature: [Recommended temperature: 15 °C to 25 °C (59 °F to 77 °F), Recommended humidity: 40%RH to 60%RH]
- Always remove the battery and the card from the camera.
- If the battery is left inserted in the camera, it will discharge even if the camera is turned off. If the battery continues to be left in the camera, it will discharge excessively and may become unusable even if charged.
- When storing the battery for a long period of time, we recommend charging it once a year. Remove the battery from the camera and store it again after it has completely discharged.
- We recommend storing the camera with a desiccant (silica gel) when you keep it in a closet or a cabinet.

About the picture data

Recorded data may be damaged or lost if the camera breaks down due to inappropriate handling. Panasonic will not be liable for any damage suffered due to loss of recorded data.

About tripods or unipods

- When you use a tripod, make sure the tripod is stable when this unit is attached to it.
- You may not be able to remove the card or the battery when using a tripod or unipod.
- Make sure that the screw on the tripod or unipod is not at an angle when attaching or detaching the camera. You may damage the screw on the camera if you use excessive force when turning it. Also, the camera body and the rating label may be damaged or scratched if the camera is attached too tightly to the tripod or unipod.
- Read the operating instructions for the tripod or unipod carefully.
- Some tripods or unipods may block the speaker, making it difficult to hear operating sounds etc.

Message Display

Confirmation messages or error messages will be displayed on the screen in some cases. The major messages are described below as examples.

[This picture is protected]

- Delete the picture after cancelling the protect setting. (P117)

[Some pictures cannot be deleted]/[This picture cannot be deleted]

- Pictures not based on the DCF standard cannot be deleted.
 - Format the card after saving necessary data on a PC etc. (P50)

[Cannot be set on this picture]

- [Text Stamp] or [Print Set] cannot be set for pictures not based on the DCF standard.

[Built-in memory full]/[Memory card full]/[Not enough space on built-in memory]/[Not enough memory on the card]

- There is no space left on the built-in memory or the card.
- When you copy pictures from the built-in memory to the card (batch copy), the pictures are copied until the capacity of the card becomes full.

[Some pictures cannot be copied]/[Copy could not be completed]

- The following pictures cannot be copied.
 - When a picture with the same name as the picture to be copied exists in the copy destination. (Only when copying from a card to the built-in memory.)
 - Files not based on the DCF standard.
- Moreover, pictures recorded or edited by other equipment may not be copied.

[Built-In Memory Error]/[Format built-in memory?]

- This message will be displayed when you format the built-in memory on a PC.
 - Format the built-in memory on the camera again. (P50) The data on the built-in memory will be deleted.

[Memory card error.

This card cannot be used in this camera.

Format this card?]

- It is a format that cannot be used with this unit.
 - Insert a different card and try again.
 - Reformat on this unit (P50) after saving necessary data using a PC, etc. Data will be deleted.

[Please turn camera off and then on again]/[System Error]

- This message will be displayed when the lens did not operate properly.
 - Turn the camera off and on. If the message persists, contact the dealer or Panasonic.

[Memory Card Error]/[Memory card parameter error]/[This memory card cannot be used]

- Use a card compatible with this unit. (P22)
- SD Memory Card (8 MB to 2 GB)
- SDHC Memory Card (4 GB to 32 GB)
- SDXC Memory Card (48 GB, 64 GB)

[Insert SD card again]/[Try another card]

- An error has occurred accessing the card.
 - Insert the card again.
 - Insert a different card.

**[Read Error/Write Error
Please check the card]**

- It has failed to read or write data.
 - Remove the card after turning this unit off. Insert the card again, turn this unit on, and try to read or write the data again.
- The card may be broken.
 - Insert a different card.

[Motion recording was cancelled due to the limitation of the writing speed of the card]

- Use a card with SD Speed Class with “Class 4” or higher when recording motion pictures.
- In the event that it stops even after using a “Class 4” card or higher, the data writing speed has deteriorated so it is recommended to make a backup and then format (P50).
- Depending on the type of the card, motion picture recording may stop in the middle.

[Cannot record due to incompatible format(NTSC/PAL) data on this card.]

- Format the card after saving necessary data on a PC etc. (P50)
- Insert a different card.

[A folder cannot be created]

- A folder cannot be created because there are no remaining folder numbers that can be used.
→ Format the card after saving necessary data on a PC etc. (P50) If you execute [No.Reset] in the [Setup] menu after formatting, the folder number is reset to 100. (P48)

[Picture is displayed for 16:9 TV]/[Picture is displayed for 4:3 TV]

- Select [TV Aspect] in the [Setup] menu if you want to change the TV aspect. (P49)
- This message also appears when the USB connection cable is connected to the camera only. In this case, connect the other end of the USB connection cable to a PC or a printer. (P124, 127)

[Editing operation cannot proceed as information processing is ongoing.]

- If a card inserted into the unit contains a group of pictures taken in [Time Lapse Shot] and one or more pictures from the group have been deleted or have had their file names changed in a PC or other device, the unit automatically retrieves new information and reconstitutes the group. When there are many image files, the currently retrieving information icon [] may be displayed for a significant period on the playback screen. During this period, it will not be possible to use delete or the playback menu.
If you turn off this unit while information is being retrieved, only the still pictures for which data has been retrieved will be saved as the group. When you switch on again, the information retrieval will restart from the same point.

[This battery cannot be used]

- Use a genuine Panasonic battery. If this message is displayed even when a genuine Panasonic battery is used, contact the dealer or Panasonic.
- If the battery terminal is dirty, clean it and remove any objects.

[To prevent water leakage, ensure that the door is locked properly.]

- Refer to P21 for details.

Troubleshooting

First, try out the following procedures (P145–154).

If the problem is not resolved, **it may be improved by selecting [Reset] (P48) on the [Setup] menu.**

Battery and power source

**The camera cannot be operated even when it is turned on.
The camera turns off immediately after it is turned on.**

- The battery is exhausted. Charge the battery.
- If you leave the camera on, the battery will be exhausted.
→ Turn the camera off frequently by using the [Auto Power Off] etc. (P47)

Side door does not close.

- Insert all the way until you hear a locking sound and it is locked by the lever while being careful about the direction the battery is inserted. (P20)

Recording

The picture cannot be recorded.

- Is there any memory remaining on the built-in memory or the card?
→ Delete the pictures which are not necessary to increase available space in the memory. (P39)
- You may not be able to record for a short while after turning this unit on when using a large capacity card.

The recorded picture is whitish.

- The picture can become whitish if there is dirt, e.g. fingerprints on the lens.
→ When it is dirty, lightly wipe the surface of the lens with soft and dry cloth.
- Is the inside of the lens fogged?
→ There is condensation. Refer to “When inner side of the lens is fogged (condensation)” on P7 for what to do.

The recorded picture is too bright or dark.

→ Check that the exposure is correctly compensated. (P60)

Multiple pictures are taken at one time.

→ Set Auto Bracket (P61) or [Burst] (P90) of the [Rec] menu to [OFF].

The subject is not focused properly.

- The focus range varies depending on the Recording Mode.
 - Set to the proper mode for the distance to the subject.
- The subject is beyond the focus range of the camera. (P33)
- There is camera shake (jitter) or the subject is moving slightly. (P27)

The recorded picture is blurred. The Optical Image Stabiliser is not effective.

- The shutter speed becomes slower when pictures are taken in dark places so hold the camera firmly with both hands to take the pictures. (P27)
- When taking pictures at a slow shutter speed, use the Self-timer. (P59)

Taking pictures using Auto Bracket is not possible.

- Is there any memory remaining on the built-in memory or the card?

The recorded picture looks rough. Noise appears on the picture.

- Is the ISO sensitivity high or the shutter speed slow?
(ISO sensitivity is set to [ISO] when the camera is shipped. Therefore, when taking pictures indoors etc. noise will appear.)
 - Decrease the ISO sensitivity. (P79)
 - Take pictures in bright places.
- Have you set [High Sens.] in Scene Mode, or [Burst] in [Rec] menu to [H] or [B]? If so, the resolution of the recorded picture decreases slightly because of high sensitivity processing, but this is not a malfunction.

The brightness or the hue of the recorded picture is different from the actual scene.

- When recording under fluorescent or LED lighting fixture etc., increasing the shutter speed may introduce slight changes to brightness and colour. These are a result of the characteristics of the light source and do not indicate a malfunction.

When recording pictures or half-pressing the shutter button, reddish stripes may appear on the LCD monitor. Alternatively, part or all of the LCD monitor may turn a reddish colour.

- This is a characteristic of CCDs, and it appears when the subject has a bright part. Some unevenness may occur in the surrounding areas, but this is not a malfunction.

It is recorded in motion pictures but is not recorded on still pictures.

- It is recommended that when you take pictures you take care not to expose the screen to sunlight or any other source of strong light.



Motion picture recording stops in the middle.

- Use a card with SD Speed Class with “Class 4” or higher when recording motion pictures.
- Depending on the type of the card, recording may stop in the middle.
 - If motion picture recording stops during use of a card of at least “Class 4” or if you use a card that has been formatted on a PC or other equipment, the data-writing speed is lower. In such cases, we recommend that you make a backup of the data and then format (P50) the card in this unit.

Subject cannot be locked. (AF tracking not possible)

- Set the AF area to the distinctive colour of the subject if there is a part that is different from the surrounding colour. (P84)

Recording by [Panorama Shot] is ended before finishing.

- If the camera is moved too slowly, the camera has assumed that camera motion was stopped and ended the still picture recording.
- If there is large shaking towards the recording direction while moving the camera, recording is ended.
 - When recording in [Panorama Shot], try to trace a small half-circle parallel to the recording direction, taking about 4 seconds to complete the half-circle (approximate).

Operation sound is small.

- Is your finger covering up the speaker? (P15)

Lens

Recorded image may be warped, or nonexistent colour is surrounding the subject.

- It is possible that the subject may be warped slightly, or the borders get coloured, depending on the zoom magnification, due to the characteristics of the lens. Also, the peripherals of the image might look warped because the perspective is enhanced when the wide angle is used. This is not a malfunction.

The inner side of the lens is fogged.

- The inside of the lens may fog due to condensation depending on the environment this unit is used in, areas that undergo a significant change in temperature or in high humidity, etc. Refer to “When inner side of the lens is fogged (condensation)” on P7 for what to do.

LCD monitor

The LCD monitor becomes darker or brighter for a moment.

- This phenomenon appears when you press the shutter button halfway to set the aperture value and does not affect the recorded pictures.
- This phenomenon also appears when the brightness changes when the camera is zoomed or when the camera is moved. This is because of operation of the automatic aperture of the camera, and it is not a malfunction.

The LCD monitor flickers indoors.

- The LCD monitor may flicker for a few seconds after this unit is turned on. This is an operation to correct flicker caused by lighting such as fluorescent lights, LED lights etc. and is not a malfunction.

The LCD monitor is too bright or dark.

- Is [Monitor Luminance] active? (P45)
- Perform [Monitor Display]. (P44)

Black, red, blue and green dots appear on the LCD monitor.



- This is not a malfunction.
These pixels do not affect the recorded pictures.

Noise appears on the LCD monitor.

- In dark places, noise may appear to maintain the brightness of the LCD monitor. This does not affect the pictures you are recording.

Flash

The flash is not activated.

- Is the flash setting set to ?
 - Change the flash setting. (P54)
- The flash cannot be used in the following cases:
 - When using Auto Bracket (P61)
 - Creative Control Mode (P62)
 - [Panorama Shot] (P69)
 - [Scenery]/[Night Scenery]/[Sunset]/[Starry Sky]/[Glass Through] (Scene Mode) (P72)
 - When recording in [Burst] (except for ) (P90)

Flash is activated several times.

- The flash is activated twice when Red-Eye Reduction (P55) has been set.
- Has [Burst] (P90) in the [Rec] menu been set to ?

Playback

The picture being played back is rotated and displayed in an unexpected direction.

- [Rotate Disp.] (P49) is set to   or .

The picture is not played back.

The recorded pictures are not displayed.

- Is there a picture on the built-in memory or the card?
 - The pictures on the built-in memory appear when a card is not inserted. The picture data on the card appears when a card is inserted.
- Is this a folder or picture which was processed in the PC? If it is, it cannot be played back by this unit.
 - It is recommended to use the “PHOTOfunSTUDIO” software in the CD-ROM (supplied) to write pictures from PC to card.
- Are you playing back filtered images by using [Slide Show] or [Filtering Play]?
 - Cancel the filter. (P101)

The folder number and the file number are displayed as [—] and the screen turns black.

- Is this a non-standard picture, a picture which has been edited using a PC or a picture which was taken by another maker of digital cameras?
- Did you remove the battery immediately after picture-taking or did you take the picture using a battery with a low remaining charge?
→ Format the data to delete the pictures mentioned above. (P50)
(Other pictures will be deleted as well and it will not be possible to restore them. Therefore, check well before formatting.)

Playback sound or operation sound is small.

- Is something covering up the speaker? (P15)

With a Calendar Search, pictures display dates differing from the actual dates on which the pictures were taken.

- Is the clock in the camera set properly? (P25)
- When pictures edited using a PC or pictures taken by other equipment are searched, they may display dates differing from the actual dates on which the pictures were taken.

White round spots like soap bubbles appear on the recorded picture.

- If you take a picture with the flash in a dark place or indoors, white round spots may appear on the picture caused by the flash reflecting off of particles of dust in the air. This is not a malfunction.
A characteristic of this is that the number of round spots and their position differ in every picture.

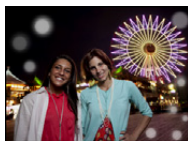

Red part of the recorded image has changed colour to black.

- When Red-Eye Removal ([~~A~~], [~~S~~]) is in operation, if you take a picture of a subject with red colour surrounded by a skin tone colour, that red part may be corrected to black by the Red-Eye Removal function.
→ It is recommended to take a picture with the Flash Mode set to [~~A~~], [~~S~~] or [~~☺~~], or [Red-Eye Removal] on the [Rec] menu set to [OFF]. (P96)

[Thumbnail is displayed] appears on the screen.

- Is it a picture that has been recorded with other equipment? In such cases, these pictures may be displayed with a deteriorated picture quality.

The sound of the recorded motion pictures sometimes breaks up.

- This unit automatically adjusts the aperture during motion picture recording. At such times, the sound may break up. This is not a malfunction.

Motion pictures recorded with this model cannot be played back on other equipment.

- Even if a compatible MP4 playback device is used, the video or sound quality of the recorded motion pictures may be poor, or they may not be able to be played. The recorded data may also not be displayed properly in certain cases.

TV, PC and printer**The picture does not appear on the television.**

- Is the camera connected to the TV correctly?
→ Set the TV input to External Input Mode.

The display areas on the TV screen and the camera's LCD monitor are different.

- Depending on the TV model, the pictures may be elongated horizontally or vertically or they may be displayed with their edges cut off.

The motion pictures cannot be played back on a TV.

- Are you trying to play back the motion pictures by directly inserting the card in the card slot of the TV?
→ Connect the camera to the TV with the AV cable (optional) and then play back the pictures on the camera. (P120)

The picture is not displayed fully on the TV.

- Check [TV Aspect] setting. (P49)

Cannot communicate with the PC.

- Is the camera connected to the PC correctly?
- Is the camera recognised by the PC correctly?
 - Select [PC] when connecting. (P124)
 - Turn this unit off and on.

The card is not recognised by the PC. (The built-in memory is recognised.)

- Disconnect the USB connection cable. Connect it again while the card is inserted in the camera.
- If there are two or more USB terminal on a single PC, try connecting the USB connection cable to another USB terminal.

The card is not recognised by the PC. (SDXC memory card is used)

- Check if your PC is compatible with SDXC memory cards.
<http://panasonic.net/avc/sdcard/information/SDXC.html>
- A message prompting to format the card may be displayed when connecting, but do not format.
- If the [Access] displayed on the LCD monitor does not disappear, disconnect the USB connection cable after turning this unit off.

The picture cannot be printed when the camera is connected to a printer.

- Pictures cannot be printed using a printer that does not support PictBridge.
 - Select [PictBridge(PTP)] when connecting. (P127)

The ends of the pictures are cut at printing.

- When using a printer with a Cropping or borderless printing function, cancel this function before printing. (For details, refer to the operating instructions for the printer.)
- When you order photo studios to print pictures, ask the photo studio if the 16:9 pictures can be printed.

The panorama picture is not printing correctly.



- Since aspect ratio of a panorama picture differs from normal pictures, it may not always be possible to print it correctly.
 - Please use a printer that supports panorama pictures. (For details, please see the operating instructions of your printer)
 - We recommend using the "PHOTOfunSTUDIO" software on the CD-ROM (supplied) to adjust the size of the still picture to the print paper size.

Others

[Requirements for Underwater use] is displayed repeatedly whenever this unit is turned on.

- Press [MENU/SET] after viewing the last screen (12/12). For details, refer to P9.

An unreadable language was selected by mistake.

- Press [MENU/SET], select the [Setup] menu icon []. Then press [MENU/SET], and then select the [] icon to set the desired language. (P50)

A white lamp sometimes turns on when the shutter button is pressed halfway.

- AF Assist Lamp will turn on white in the dark place to assist the focusing.

The AF Assist Lamp does not turn on.

- Is [AF Assist Lamp] on the [Rec] menu set to [ON]? (P95)
- The AF Assist Lamp does not turn on in bright places.

The camera becomes warm.

- The surface of the camera may become warm during use. This does not affect the performance or quality of the camera.

The lens clicks.

- When the brightness changes due to zoom or camera movement, etc., the lens may click and the picture on the screen may drastically change. However, the picture is not affected. The sound is caused by the automatic adjustment of the aperture. This is not a malfunction.

The side door will not close.

- Have foreign objects become trapped?
→ Remove the foreign objects. (P10)
- When closing, do not set the [LOCK] switch to the locked side. Doing so may cause damage or leaks.
→ Release the lock. (P20)

A part of the camera such as the zoom button and side door does not move.

- If the camera is used in cold places such as ski resorts or places at high altitude with the snow or water droplets adhered to the camera, some parts of the camera may become hard to move with snow or water droplets freezing in the gap of the zoom button or the camera [ON/OFF] button. This is not a malfunction. When the camera returns to normal temperature it will function as normal.
- When using the camera in a place with sand or dust, some parts of the camera may become hard to move with foreign objects getting in the gap of the zoom button, or the camera [ON/OFF] button. Wipe off with a dry, lint-free cloth or rinse with fresh water.

The camera makes a rattling sound or you can feel some vibration.

- Below cases are not malfunctions, so you can use the camera as normal.
 - You hear a “rattling” sound when the camera is shaken while this unit is turned off or during Playback Mode (this is the sound of the lens moving).
 - When this unit is turned on or off, or when switching from recording to Playback Mode, there is a rattling noise (this is the sound of the lens moving).
 - When zooming, you can feel some vibration (this is caused by the lens moving).

The clock is reset.

- If you do not use the camera for a long time, the clock may be reset.
 - [Please set the clock] message will be displayed, please reset the clock. (P25)

When pictures are taken using the zoom, they are slightly distorted and the areas around the subject contain colours which are not actually present.

- It is possible that the subject may be warped slightly, or the borders get coloured, depending on the zoom magnification, due to the characteristics of the lens, but this is not a malfunction.

Zooming stops instantaneously.

- When using the Extra Optical Zoom, the zooming action will stop temporarily. This is not a malfunction.

Zoom does not go up to maximum magnification.

- Is the camera set to Macro Zoom Mode? (P58)
Maximum zoom during Macro Zoom Mode is 3× digital zoom.

The file numbers are not recorded consecutively.

- When you perform an operation after taking a certain action, the pictures may be recorded in folders with different numbers from the ones used prior to the operation.

The file numbers are recorded with previously used numbers.

- If you insert or remove the battery before turning off this unit, the folder and file numbers for the pictures taken will not be stored in the memory. When this unit is turned on again and pictures are taken, they may be stored under file numbers which should have been assigned to previous pictures.

The card cannot be formatted.

- Formatting is not available in Intelligent Auto Mode. Switch the recording mode to another one. (P50)

- SDXC Logo is a trademark of SD-3C, LLC.
- QuickTime and the QuickTime logo are trademarks or registered trademarks of Apple Inc., used under license therefrom.
- Mac and Mac OS are trademarks of Apple Inc., registered in the U.S. and other countries.
- SILKYPIX® is a registered trademark of Ichikawa Soft Laboratory.
- Windows and Windows Vista are either registered trademarks or trademarks of Microsoft Corporation in the United States and/or other countries.
- This product uses "DynaFont" from DynaComware Corporation. DynaFont is a registered trademark of DynaComware Taiwan Inc.
- Other names of systems and products mentioned in these instructions are usually the registered trademarks or trademarks of the manufacturers who developed the system or product concerned.



This product is licensed under the AVC patent portfolio license for the personal and non-commercial use of a consumer to (i) encode video in compliance with the AVC Standard ("AVC Video") and/or (ii) decode AVC Video that was encoded by a consumer engaged in a personal and non-commercial activity and/or was obtained from a video provider licensed to provide AVC Video. No license is granted or shall be implied for any other use. Additional information may be obtained from MPEG LA, LLC. See <http://www.mpegla.com> .