

SONY®

FM/AM Cassette Car Stereo

Operating Instructions _____

EN

Owner's Record

The model and serial numbers are located on the bottom of the unit.

Record the serial number in the space provided below.

Refer to these numbers whenever you call upon your Sony dealer regarding this product.

Model No. XR-C9100 Serial No. _____

For installation and connections, see the supplied installation/connections manual.

BBE®

XR-C9100

© 1998 by Sony Corporation

Warning

This equipment has been tested and found to comply with the limits for a Class B digital device, pursuant to Part 15 of the FCC Rules. These limits are designed to provide reasonable protection against harmful interference in a residential installation. This equipment generates, uses, and can radiate radio frequency energy and, if not installed and used in accordance with the instructions, may cause harmful interference to radio communications. However, there is no guarantee that interference will not occur in a particular installation. If this equipment does cause harmful interference to radio or television reception, which can be determined by turning the equipment off and on, the user is encouraged to try to correct the interference by one or more of the following measures:

- Reorient or relocate the receiving antenna.
- Increase the separation between the equipment and receiver.
- Connect the equipment into an outlet on a circuit different from that to which the receiver is connected.
- Consult the dealer or an experienced radio/TV technician for help.

You are cautioned that any changes or modifications not expressly approved in this manual could void your authority to operate this equipment.

EN

Welcome !

Thank you for purchasing this Sony Cassette Player. This unit lets you enjoy a variety of features by using a supplied rotary commander or an optional wireless remote.

In addition to the Cassette playback and radio operations, you can expand your system by connecting an optional CD/MD unit*¹. When you operate this unit or a connected optional CD unit with the CD TEXT function, the CD TEXT information will appear in the display when you play back a CD TEXT disc*².

*¹ You can also connect a CD changer or an MD changer.

*² A CD TEXT disc is an audio CD that includes information such as the disc name, artist name and track names.
This information is recorded on the disc.

Voice guide for safe driving

This unit has a voice guide function*. When the voice guide function is on, the unit gives vocalized comments on functions corresponding the buttons pushed.

* Some optional power amplifiers may cause a break at the beginning of vocalized comments. When you connect an optional MD changer, the sound from the first MD may continue for a short time even after the vocalized comments about the second MD are announced.

BBE*

With BBE, you can obtain a sharp edged bass for a more natural and clear sound. When reproduced from CDs, MDs, tapes, or radio, treble tones have a slight tendency to delay compared with the bass which may result in unclear sound reproduction due to the masking effect of the bass. The BBE reproduces, as close as is possible, the original sound by adjusting the sound balance of the bass.

* The BBE is manufactured by Sony Corporation under license from BBE Sound, Inc. It is covered by U.S. Patent No.4,638,258 and No.4,482,866. The word "BBE" and the BBE Symbol are the trademarks of BBE Sound, Inc.

Table of Contents

This Unit Only

Location of controls 4

Getting Started

Resetting the unit 6

Detaching the front panel 6

Preparing the rotary commander 7

Setting the clock 7

Cassette Player

Listening to a tape 8

Playing a tape in various modes 9

Radio

Memorizing stations automatically
— Best Tuning Memory (BTM) 10

Memorizing only the desired stations 11

Receiving the memorized stations 11

Storing the station names
— Station Memo 12

Locating a station by name
— List-up 13

Other Functions

Using the rotary commander 13

Adjusting the sound characteristics 15

Attenuating the sound 15

Changing the sound and display settings 15

Adjusting the frequency of
the subwoofer(s) 16

With Optional Equipment

CD/MD Unit

Playing a CD or MD 17

Scanning the tracks
— Intro Scan 18

Playing tracks repeatedly
— Repeat Play 18

Playing tracks in random order
— Shuffle Play 18

Creating a program
— Program Memory 19

Labeling a CD
— Disc Memo 21

Locating a disc by name
— List-up 23

Selecting specific tracks for playback
— Bank 23

DSP

Selecting a surround menu 24

Storing a surround effect onto CDs
— Digital Signal Processor (DSP)
Custom File 25

Selecting the listening position 26

Adjusting the fader (FAD) 27

Adjusting the volume of the subwoofer(s) ... 27

Adjusting the volume of the bass
and treble 28

Listening to each program source in
its registered surround menu
— Last Sound Memory (LSM) 28

Changing the line output level 28

TV/Video

Watching the TV 29

Watching a video 29

Memorizing TV channels automatically 29

Memorizing only the desired TV channels ... 29

Storing the TV channel names 30

Displaying the information stored on discs .. 30

Watching the TV or video while listening to
a tape, CD or MD
— Simultaneous Play 31

Additional Information

Precautions 32

Maintenance 33

Dismounting the unit 33

Specifications 34

Troubleshooting guide 35

Location of controls

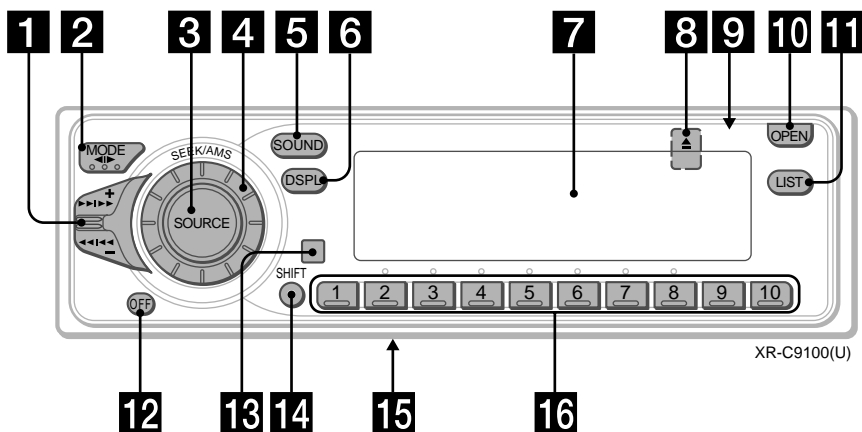

Refer to the pages for details.

EN

- 1** SEEK/AMS (seek/Automatic Music Sensor/manual search) control 9, 11, 18, 19, 20, 23, 29
- 2** MODE (◀▶) button
During tape playback:
Playback direction change 8, 9
During tuner reception:
BAND select 10, 11
During CD or MD playback:
CD/MD Unit select 17, 19, 22
During TV reception or Video playback:
TV/Video select 29
- 3** SOURCE (TAPE/TUNER/CD/MD/TV) button 8, 10, 11, 16, 17, 19, 22, 24, 25, 27, 28, 29, 31
- 4** Dial (volume/subwoofer volume/bass/treble/left-right/rear-front control) 7, 12, 15, 21, 22, 24, 25, 26, 27, 28
- 5** SOUND button 15, 24, 25, 26, 27, 28
- 6** DSPL (display mode change) button 9, 12, 13, 17, 22, 23
- 7** Display window
- 8** ▲ (eject) button (located on the front side of the unit behind the front panel) 8
- 9** Reset button (located on the front side of the unit behind the front panel) 6
- 10** OPEN button 6, 8, 33
- 11** LIST button
Station Memo 12
List-up 13, 23, 30
Disc Memo 21, 22
DSP Custom File 25
- 12** OFF button 6, 8
- 13** Sensor for the optional wireless remote
- 14** SHIFT button
PLAY MODE 9, 10, 11, 18, 19, 20, 21, 23, 24, 25, 29
REP 10, 18
SET UP 7, 16, 17, 28
SHUF 18
- 15** POWER SELECT switch (located on the bottom of the unit)
See "POWER SELECT Switch" in the Installation/Connections manual.
- 16** During radio reception:
Number buttons 11
During CD or MD playback:
Direct disc selection buttons 18
During TV reception:
Number buttons 29

**Optional wireless remote
(RM-X47)**

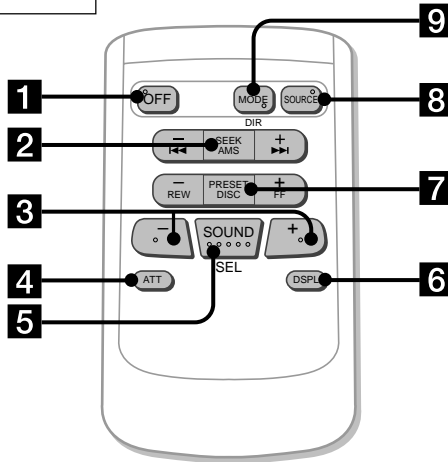

EN

The buttons of the wireless remote control the same functions as those on this unit.

- | | |
|---|---|
| <ul style="list-style-type: none"> 1 OFF button 2 SEEK/AMS button 3 buttons 4 ATT button 5 SOUND/SEL button 6 DSPL button | <ul style="list-style-type: none"> 7 PRESET/DISC button
<i>You cannot do manual search and manual tuning with the remote.</i> 8 SOURCE button 9 MODE/DIR button
 controls the same function on this unit. |
|---|---|

When the POWER SELECT switch is set to the **B** position, the unit cannot be operated with the wireless remote unless on the unit is pressed or a cassette is inserted to activate the unit first.

Getting Started

Resetting the unit

Before operating the unit for the first time or after replacing the car battery, you must reset the unit.

Press the reset button with a pointed object, such as a ball-point pen.

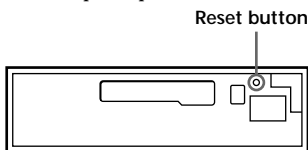

Note

Pressing the reset button will erase the clock and some memorized functions.

Attaching the front panel

Place the hole **a** in the front panel onto the spindle **b** on the unit as illustrated, then push the left side in.

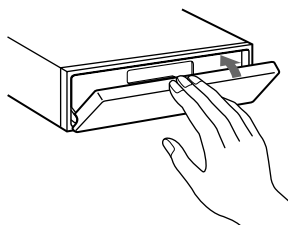
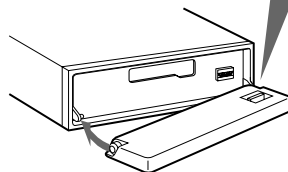
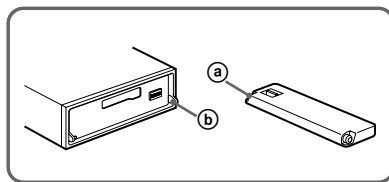

Detaching the front panel

You can detach the front panel of this unit to protect the unit from being stolen.

1 Press **OFF**.

2 Press **OPEN** to open up the front panel, then slide the front panel to the right side, and pull out from the left side of the front panel.

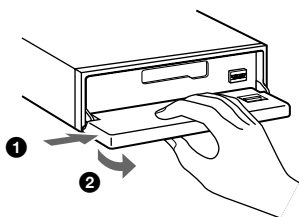

Notes

- Do not place anything on the inner surface of the front panel.
- Be sure not to drop the panel when detaching it from the unit.
- If you detach the panel while the unit is still on, the power will turn off automatically to prevent the speakers from being damaged.
- When you carry the front panel with you, put it in the supplied front panel case.

Notes

- Be sure not to attach the front panel upside down.
- Do not press the front panel hard against the unit when attaching it. Press it lightly against the unit.
- Do not press hard or put excessive pressure on the display windows of the front panel.
- Do not expose the front panel to direct sunlight or heat sources such as hot air ducts, and do not leave it in a humid place. Never leave it on the dashboard of a car parked in direct sunlight where there may be a considerable rise in temperature.

Caution alarm

If you turn the ignition key switch to the OFF position without removing the front panel, the caution alarm will beep for a few seconds (only when the POWER SELECT switch on the bottom of the unit is set to the (A) position).

Preparing the rotary commander

When you mount the rotary commander, attach the label as shown in the illustration below.

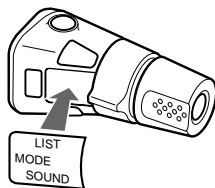
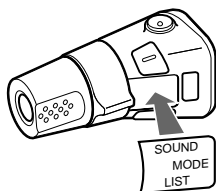

Setting the clock

The clock uses a 12-hour digital indication.

Example: To set the clock to 10:08

- 1 Press (SHIFT), then press (3) (SET UP).

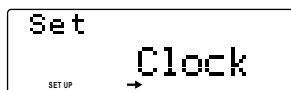

- 1 Press (5) (→).

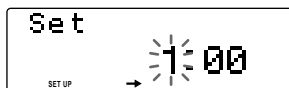

The hour digit flashes.

- 2 Set the hour.

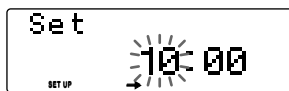

- 3 Press (5) (→).

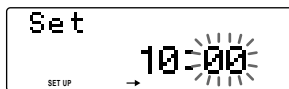

The minute digits flash.

- 4 Set the minute.

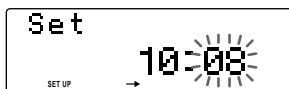

- 2 Press (SHIFT).



The clock starts.

3 Press **(SHIFT)**.

After the mode setting is complete, the display returns to normal playback mode.

Note

If the **POWER SELECT** switch on the bottom of the unit is set to the **B** position, turn the power on first, then set the clock.

Cassette Player

Listening to a tape

1 Press **(OPEN)** and insert a cassette.

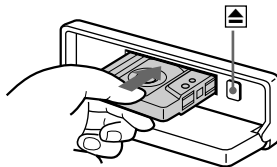

2 Close the front panel.
Playback starts automatically.

If a cassette is already inserted, press **(SOURCE)** repeatedly until "FWD" or "REV" appears to start playback.

The side facing up is being played.



The side facing down is being played.



Tips

- To change the tape's playback direction, press **(MODE)** (**◀▶**).
- "Metal" appears in the display when you insert a metal or CrO₂ tape (Auto Metal function).

To	Press
Stop playback	(OFF)
Eject the cassette	(OPEN) then ▲

Fast-winding the tape

During playback, push the SEEK/AMS control up or down and hold.

Fast-forward

Rewind



To start playback during fast-forwarding or rewinding, press (MODE).

Locating a specific track

— Automatic Music Sensor (AMS)

You can skip up to nine tracks at one time.

During playback, push the SEEK/AMS control up or down momentarily.

To locate succeeding tracks

To locate preceding tracks

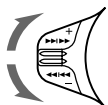

Note

The AMS function may not work when:

- the blanks between tracks are shorter than four seconds
- there is noise between tracks
- there are long sections of low volume or quiet sections.

Changing the display item

Each time you press (DSPL), the item changes as follows:

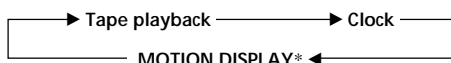

* All the items above are scrolled in the display one by one in order.

Playing a tape in various modes

You can play the tape in various modes:

- Intro (Intro Scan) lets you play the first 10 seconds of all the tracks.
- NR (Dolby NR) lets you select the Dolby* NR B or C system.
- B. Skip (Blank Skip) skips blanks longer than eight seconds.
- ATA (Automatic Tuner Activation) turns on the tuner automatically while fast-winding the tape.
- Repeat (Repeat Play) repeats the current track.

* Dolby noise reduction manufactured under license from Dolby Laboratories Licensing Corporation. "DOLBY" and the double-D symbol  are trademarks of Dolby Laboratories Licensing Corporation.

Searching for the desired track

— Intro scan

1 Press (SHIFT).

Every time you press (SHIFT), only the items you can select light up.

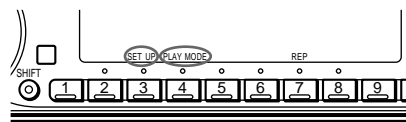

2 Press (4) (PLAY MODE) repeatedly until "Intro" appears.

Each time you press (4) (PLAY MODE), the item changes as follows:

Intro → NR → B. Skip → ATA



3 Press (5) (→) to select "Intro on."

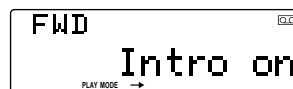

Intro Scan starts.

4 Press (SHIFT).

To go back to normal playback mode, select "Intro off" in step 3 above.

Playing tracks repeatedly

— Repeat Play

- 1 During playback, press **(SHIFT)**.
- 2 Press **(7)** (REP) repeatedly until "Repeat" appears.

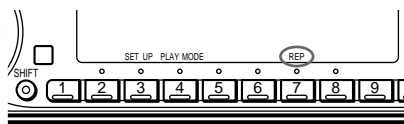

Repeat Play starts.

- 3 Press **(SHIFT)**.

To go back to normal playback mode, select "Repeat off" in step 2 above.

Radio

Memorizing stations automatically

— Best Tuning Memory (BTM)

The unit selects the stations with the strongest signals and memorizes them in the order of their frequencies. You can store up to 10 stations on each band (FM1, FM2, and AM).

Caution

When tuning in stations while driving, use Best Tuning Memory to prevent accidents.

- 1 Press **(SOURCE)** repeatedly to select the tuner.
Each time you press **(SOURCE)**, the source changes as follows:
TAPE ↔ TUNER
- 2 Press **(MODE)** repeatedly to select the band.
Each time you press **(MODE)**, the band changes as follows:
A diagram showing a sequence of three rectangular boxes. The first box contains 'FM1', the second contains 'FM2', and the third contains 'AM'. Arrows point from the first box to the second, and from the second box to the third.
- 3 Press **(SHIFT)**, then press **(4)** (PLAY MODE) repeatedly until "B.T.M" appears.
- 4 Press **(5)** (→).
The unit stores stations in the order of their frequencies on the number buttons.
The setting is stored with a beep sound.

- 5 Press **(SHIFT)**.

Notes

- The unit does not store stations with weak signals. If only a few stations can be received, some number buttons will retain their former setting.
- When a number is indicated in the display, the unit starts storing stations from the one currently displayed.

Memorizing only the desired stations

You can preset up to 20 FM stations (10 for FM1 and 10 for FM2) and up to 10 AM stations in the order of your choice.

- 1 Press **(SOURCE)** repeatedly to select the tuner.
- 2 Press **(MODE)** repeatedly to select the band (FM1, FM2, or AM).
- 3 Push the SEEK/AMS control up or down to tune in the station you want to store on the number button.
- 4 Press and hold the desired number button (**(1)** to **(10)**) until "MEM" appears.
The number button indication appears in the display.

Note

If you try to store another station on the same number button, the previously stored station will be erased.

Receiving the memorized stations

- 1 Press **(SOURCE)** repeatedly to select the tuner.
- 2 Press **(MODE)** repeatedly to select the band (FM1, FM2, or AM).
- 3 Press the number button (**(1)** to **(10)**) momentarily where the desired station is stored.

If you cannot tune in a preset station

Push the SEEK/AMS control up or down momentarily to search for the station (automatic tuning).

Scanning stops when the unit receives a station. Push the SEEK/AMS control up or down repeatedly until the desired station is received.

Note

If the automatic tuning stops too frequently, press **(SHIFT)**, then press **(4)** (PLAY MODE) repeatedly until "Local" (local seek mode) is displayed. Then press **(5)** (→) to select "Local on." Press **(SHIFT)**. Only the stations with relatively strong signals will be tuned in.

Tip

If you know the frequency of the station you want to listen to, push the SEEK/AMS control up or down and hold until the desired frequency appears (manual tuning).

If FM stereo reception is poor

— Monaural Mode

- 1 Press **(SHIFT)**, then press **(4)** (PLAY MODE) repeatedly until "Mono" appears.
- 2 Press **(5)** (→) repeatedly until "Mono on" appears.
The sound improves, but becomes monaural ("ST" disappears).
- 3 Press **(SHIFT)**.

To go back to normal mode, select "Mono off" in step 2 above.

If interference occurs during FM reception

If there is interference from neighboring stations, follow the steps below and select "Narrow". If interference is not a problem, select "Wide" to maximize signal reception and improve sound quality or "IF Auto" to switch between "Narrow" and "Wide" automatically.

- 1 Press **(SHIFT)** during FM reception.
- 2 Press **(4)** (PLAY MODE) repeatedly until "IF Auto" appears.
- 3 Press **(5)** (→) repeatedly to select desired setting

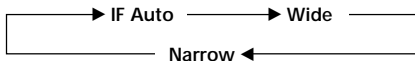

- 4 Press **(SHIFT)**.

Storing the station names

— Station Memo

You can assign a name to each radio station and store it in memory. The name of the station currently tuned in appears in the display. You can assign a name of up to eight characters per station.

Storing the station names

- 1 Tune in a station whose name you want to store.
- 2 Press **(LIST)** for two seconds.

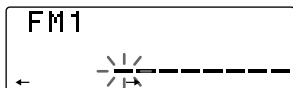

- 3 Enter the characters.
 - 1 Rotate the dial clockwise to select the desired characters.
(A → B → C → ... Z → 0 → 1 → 2 → ... 9 → + → - → * → / → \ → > → < → . → _)



If you rotate the dial counterclockwise, the characters appear in the reverse order.

If you want to put a blank space between characters, select “_” (under-bar).

- 2 Press **(5) (→)** after locating the desired character.
The flashing cursor moves to the next space.

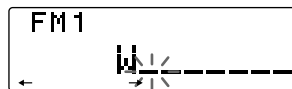

If you press **(2) (←)**, the flashing cursor moves to the left.

- 3 Repeat steps 1 and 2 to enter the entire name.

- 4 To return to the normal radio reception, press **(LIST)** for two seconds.

Tip

To erase or correct a name, enter “_” (under-bar) for each character.

Displaying the station name

Press **(DSPL)** during radio reception.

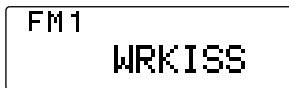

Each time you press **(DSPL)**, the item changes as follows:

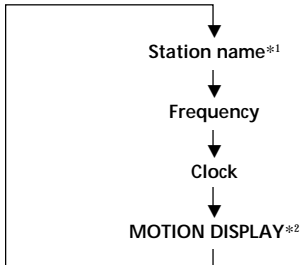

*1 If the station name of a station is not stored, “NO NAME” appears in the display for one second.

*2 All the items above are scrolled in the display one by one in order.

Erasing the station name

- 1 Tune in any station and press **(LIST)** for two seconds.
- 2 Press **(DSPL)** for two seconds.
- 3 Rotate the dial to select the name that you want to erase.
- 4 Press **(6) (ENTER)** for two seconds.
The name is erased.
Repeat steps 3 and 4 if you want to erase other names.
- 5 Press **(LIST)** for two seconds.
The unit returns to the normal radio reception mode.

Locating a station by name — List-up

- 1 Press **(LIST)** momentarily.
The name assigned to the station currently playing appears in the display.



- 2 Press **(LIST)** repeatedly until you find the desired station.
- 3 Press **(6)**(ENTER) to tune in the desired station.

Note

Once the station name or frequency has been displayed for five seconds, the display goes back to its normal mode. To turn off the display, press **(DSPL)**.

Other Functions

Using the rotary commander

The rotary commander works by pressing buttons and/or rotating controls. You can control an optional CD or MD unit with the rotary commander.

By pressing buttons (the SOURCE and MODE buttons)

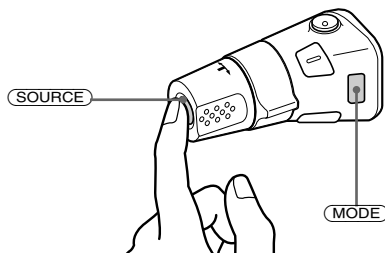

Each time you press **(SOURCE)**, the source changes as follows:

TAPE → TV* → TUNER → CD → MD

* When an optional TV tuner or video is connected.

Pressing **(MODE)** changes the operation in the following ways;

- Tape playback direction
- Tuner : FM1 → FM2 → AM
- CD unit : CD1 → CD2 → ...
- MD unit : MD1 → MD2 → ...
- TV/Video : TV → VIDEO1 → VIDEO2 → ...

Tip

When the POWER SELECT switch is set to position **(B)**, you can turn on this unit by pressing **(SOURCE)** on the rotary commander.

By rotating the control (the SEEK/AMS control)

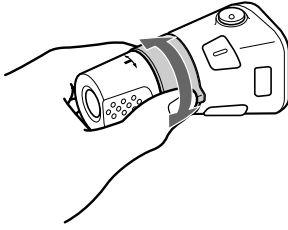

Rotate the control momentarily and release it to:

- Locate the beginnings of the tracks on the tape. Rotate and hold the control, and release it to fast-wind the tape. To playback, rotate and hold the control again, and release it.
- Locate a specific track on a disc. Rotate and hold the control until you locate the specific point in a track, then release it to start playback.
- Tune in stations automatically. Rotate and hold the control to tune in a specific station.

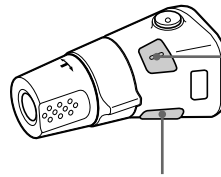

Press **SOUND** to adjust the volume and sound menu.

Press **LIST** to:

- Display the memorized names.
- Display the program type.

Changing the operative direction

The operative direction of controls is factory-set as in the illustration below.

To increase

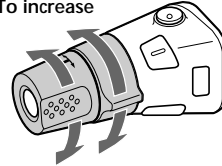

To decrease

If you need to mount the rotary commander on the right side of the steering column, you can reverse the operative direction.

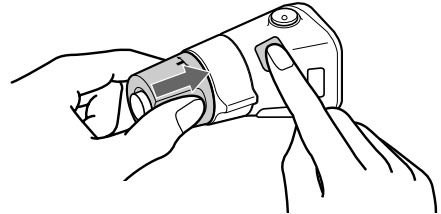

By pushing in and rotating the control (the PRESET/DISC control)

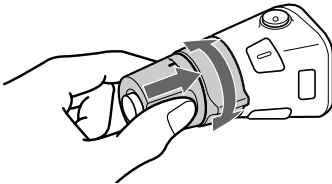

Push in and rotate the control to:

- Receive the stations memorized on the number buttons.
- Change the disc.
- Fast-winds the tape.

Press **SOUND** for two seconds while pushing the VOL control.

Tip

You can control the operative direction of controls with the unit (page 15).

Other operations

Rotate the VOL control to adjust the volume.

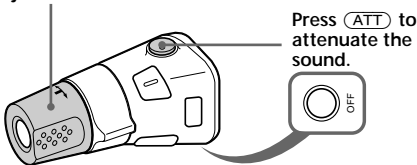

Press **ATT** to attenuate the sound.

Press **OFF** to turn off the unit.

Adjusting the sound characteristics

You can adjust the bass, treble, balance and fader.

You can store the bass and treble levels independently for each source.

1 Select the item you want to adjust by pressing **(SOUND)** repeatedly.

VOL (volume) → SUB (subwoofer volume)
→ BAS (bass) → TRE (treble)
→ BAL (left-right) → FAD (front-rear)

2 Adjust the selected item by rotating the dial.

Adjust within three seconds after selecting the item. (After three seconds, the dial function reverts to volume control.)

Attenuating the sound

Press **(ATT)** on the rotary commander or wireless remote.

“ATT on” flashes momentarily.

To restore the previous volume level, press

(ATT) again.

Tip

The unit decreases the volume automatically when a telephone call comes in (Telephone ATT function).

Changing the sound and display settings

The follow items can be set:

- Clock (page 7).
- D.Info (Dual Information) – to display the clock and the play mode at the same time (ON) or to display the information alternately (OFF).
- Amber/Green – to change the illumination color to amber or green.
- Dimmer – to change the brightness of the display.
 - Select “Auto” to dim the display only when you turn the lights on.
 - Select “on” to dim the display.
 - Select “off” to deactivate Dimmer.
- Contrast – to adjust the contrast if the indications in the display are not recognizable because of the unit’s installed position.
- Voice guide function for vocalized comments.
 - Select “Voice 1” to minimize the volume of the guide.
 - Select “Voice 2” to be louder the volume than “Voice 1.”
 - Select “Voice 3” to maximize the volume of the guide.
 - Select “Voice off” to deactivate Voice guide.
- Beep – to turn on or off the beeps.
- RM (Rotary Commander) – to change the operative direction of the controls of the rotary commander.
 - Select “norm” to use the rotary commander as the factory-set position.
 - Select “rev” when you mount the rotary commander on the right side of the steering column.
- BBE – to enjoy bass and treble even at low volume. The bass and treble will be reinforced.
 - Select “BBE 1” to reinforce the bass and treble.
 - Select “BBE 2” to reinforce the bass and treble more effectively than “BBE 1”.
 - Select “BBE off” to deactivate BBE.
- LPF (Low Pass Filter)
- A.Scr1 (Auto Scroll) (page 17).

1 Press **(SHIFT)**.

2 Press **(3)**(SET UP) repeatedly until the desired item appears.

Each time you press **(3)**(SET UP), the item changes as follows:

Clock → D.Info* → Amber/Green → Dimmer
→ Contrast → Voice* → Beep → RM → BBE*
→ LPF* → A.Scr1*

* When the radio is off, or when there is no tape, CD, or MD being played, these items will not appear.

Notes

- The displayed item will differ depending on the source.
- If an optional digital preamplifier is connected to the unit, BBE and Voice Guide do not work.

3 Press **(5)**(→) to select the desired setting (for example: on or off). For the “Contrast” setting, pressing **(5)**(→) makes the contrast higher, and pressing **(2)**(←) makes the contrast lower.

4 Press **(SHIFT)**. After the mode setting is complete, the display returns to normal playback mode.

Adjusting the frequency of the subwoofer(s)

To match the characteristics of the connected subwoofer(s), you can cut out the unwanted high and middle frequency signals entering the subwoofer(s). By setting the cut-off frequency, the subwoofer(s) will output only low frequency signals for a clearer sound image.

1 Press **(SOURCE)** to select a source (radio, tape, CD, or MD).

2 Press **(SHIFT)**, then press **(3)**(SET UP) repeatedly until “LPF” appears.

3 Press **(5)**(→) or **(2)**(←) repeatedly to select desired setting.



Set
LPF 120Hz

Each time you press **(5)**(→) or **(2)**(←), the cut-off frequency in the display changes as follows:

LPF 120 Hz ↔ LPF 80 Hz ↔ LPF off

4 Press **(SHIFT)**. When the frequency setting is complete, the display returns to the normal playback mode.

With Optional Equipment

CD/MD Unit

You can control up to 7 CD and MD units with this unit.

If you connect an optional CD unit with the CD TEXT function, the CD TEXT information will appear in the display when you play a CD TEXT disc.

Playing a CD or MD

- 1 Press **(SOURCE)** repeatedly to select the CD or MD.
- 2 Press **(MODE)** until the desired unit appears.
CD/MD playback starts.

When a CD/MD unit is connected, all the tracks play from the beginning.

Changing the display item

Each time you press **(DSPL)** during CD, CD TEXT, or MD playback, the item changes as follows:

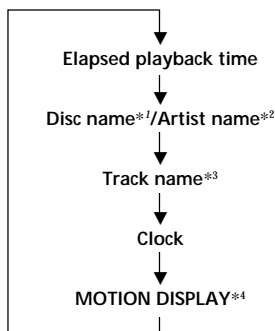

*1 If you have not labeled the disc or if there is no disc name prerecorded on the MD, "NO D.Name" appears in the display.

*2 If you play a CD TEXT disc, the artist name appears in the display after the disc name. (Only for CD TEXT discs with the artist name.)

*3 If the track name of a CD TEXT disc or MD is not prerecorded, "NO T.Name" appears in the display.

*4 All the items above are scrolled in the display one by one in order.

You can label CD and CD TEXT discs with a personalized name using the disc memo function, refer to "Labeling a CD" (page 21). However, if you use personalized labels, they will always take priority over the original CD TEXT information when such information is displayed.

Tip

If the name of the MD or CD TEXT disc is too long, you can scroll it across the display by pressing **(SHIFT)**, then **(←)**.

Automatically scrolling a disc name — Auto Scroll

If the disc name/artist name or track name on a CD TEXT disc or MD exceeds 10 characters and the Auto Scroll function is on, information automatically scrolls on the display as follows:

- The disc name appears when the disc has changed (if the disc name is selected).
- The track name appears when the track has changed (if the track name is selected).

If you press **(DSPL)** to change the display item, the disc or track name of the MD or CD TEXT disc is scrolled automatically whether you set the function on or off.

- 1 During playback, press **(SHIFT)**.
- 2 Press **(3) (SET UP)** repeatedly until "A.Scrl" appears.
- 3 Press **(5) (→)** to select "A.Scrl on."
- 4 Press **(SHIFT)**

To cancel Auto Scroll, select "A.Scrl off" in step 2 above.

Note

For some CD TEXT discs with extremely many characters, the following cases may happen:
— Some of the characters are not displayed
— Auto Scroll does not work.

Locating a specific track

— Automatic Music Sensor (AMS)

During playback, push the SEEK/AMS control up or down once for each track you want to skip.

To locate succeeding tracks

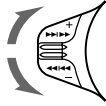

To locate preceding tracks

Locating a specific point in a track

— Manual Search

During playback, push the SEEK/AMS control up or down and hold. Release when you have found the desired point.

To search forward

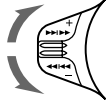

To search backward

Locating a disc by disc number

— Direct Disc Selection

Press the number button that corresponds with the desired disc number.

The desired disc in the current changer begins its playback.

EN

Scanning the tracks

— Intro Scan

You can play the first 10 seconds of all the tracks on the current disc.

1 During playback, press (SHIFT), then press (4) (PLAY MODE) repeatedly until "Intro" appears.

2 Press (5) (→) to select "Intro on." Intro Scan starts.

3 Press (SHIFT).

To go back to normal playback mode, select "Intro off" in step 2 above.

Playing tracks repeatedly

— Repeat Play

You can select:

- Repeat 1 – to repeat a track.
- Repeat 2 – to repeat a disc.

1 During playback, press (SHIFT).

2 Press (7) (REP) repeatedly until the desired setting appears.

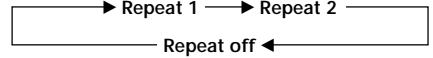

Repeat Play starts.

3 Press (SHIFT).

To return to normal playback mode, select "Repeat off" in step 2 above.

Playing tracks in random order — Shuffle Play

You can select:

- Shuf 1 – to play the tracks on the current disc in random order.
- Shuf All – to play all the tracks in random order.

1 During playback, press (SHIFT).

2 Press (8) (SHUF) repeatedly until the desired setting appears.

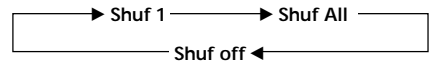

Shuffle Play starts.

3 Press (SHIFT).

To go back to normal playback mode, select "Shuf off" in step 2 above.

Creating a program

— Program Memory (CD/MD unit with the program memory function)

You can play tracks in any order of your choice by creating and storing programs in the unit's memory. You can make two programs: Program 1 and Program 2. You can select up to 12 tracks for each program. You can store the programs in the memory.

- 1 Press **(SHIFT)**, then press **(4)**(PLAY MODE) for two seconds.

Program edit mode

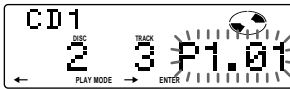

"P 1" indicates Program 1 is selected.

If you have labelled the disc, the bank edit mode appears. Press **(4)**(PLAY MODE) to display "P 1" above.

To select Program 2, press **(5)**(→) repeatedly until "P 2" appears.

- 2 Select the track you want.

- 1 Press **(SOURCE)** repeatedly to select CD or MD.
- 2 Press **(MODE)** repeatedly to select the unit.
- 3 Press **(SHIFT)**, then press the number button to select the disc.
- 4 Press **(SHIFT)**.
- 5 Push the SEEK/AMS control up or down to select the track.

- 3 Press **(6)**(ENTER) momentarily.

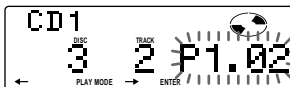
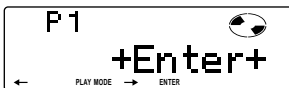

- 4 To continue entering tracks, repeat steps 2 and 3.

- 5 When you finish entering the tracks, press **(4)**(PLAY MODE) for two seconds.

- 6 Press **(SHIFT)**.

Notes

- *"**Wait**" appears in the display while the unit is reading the data, or if a disc has not been put into the unit.*
- *"*Mem Full*" appears in the display when you try to enter more than 12 tracks into a program.*

Playing the stored program

Changing the disc order in the unit will not affect the program memory play.

You can select:

- PGM 1 to - play Program 1.
- PGM 2 to - play Program 2.
- PGM 1+2 - to play Programs 1 and 2.

- 1 Press **(SHIFT)**.

- 2 Press **(4)**(PLAY MODE) repeatedly until "PGM" appears.

- 3 Press **(5)**(→) repeatedly until the desired program appears.

Program 1 playback

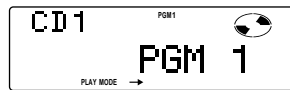

Program 2 playback

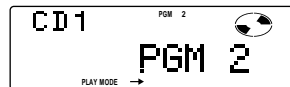

Programs 1 and 2 playback

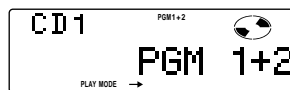

Normal playback

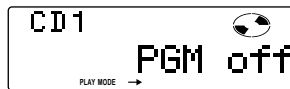

Program Play starts.

4 Press (SHIFT).

To return to normal playback mode, select "PGM off" in step 3 above.

Notes

- If you press a number button during program memory play, program memory play is interrupted, and playback of the selected disc starts.
- "NO Data" appears in the display if no track is stored in the program.
- If a track stored into the program memory is not in the disc magazine, the track will be skipped.
- When the disc magazine contains no tracks stored into the program memory, or when the program information has not been loaded yet, "Not ready" appears.

Erasing an entire program

1 Press (SHIFT), then press (4) (PLAY MODE) for two seconds.

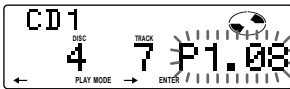

"P 1" shows Program 1 is selected.

If you have labelled the disc, the bank edit mode appears. Press (4) (PLAY MODE) to display "P 1" above.

2 Press (2) (←) repeatedly until "DEL" appears.



To erase Program 2, press (5) (→) repeatedly until "PGM 2" appears.

3 Press (6) (ENTER) for two seconds.

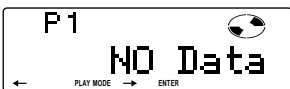

The entire program is erased.

4 When you finish erasing the programs, press (4) (PLAY MODE) for two seconds.

5 Press (SHIFT).

Adding tracks to a program

1 Press (SHIFT), then press (4) (PLAY MODE) for two seconds.

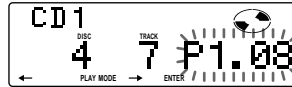

"P 1" shows Program 1 is selected.

If you have labelled the disc, the bank edit mode appears. Press (4) (PLAY MODE) to display "P 1" above.

To select Program 2, press (5) (→) repeatedly until "P 2" appears.

2 Press (2) (←) or (5) (→) to select the track slot number where you want to insert a track.

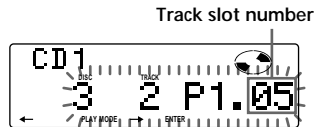

3 Push the SEEK/AMS control up or down to select the track you want to insert.

4 Press (6) (ENTER) momentarily to enter the track.

The current track in that slot number and the succeeding tracks shift down. To continue inserting tracks, repeat steps 2 through 4.

Note

Once all 12 slots have been filled, "Mem Full" appears in the display, and you cannot insert more tracks.

5 When you finish inserting tracks, press (4) (PLAY MODE) for two seconds.

6 Press (SHIFT).

Erasing tracks in a program

- 1 Press **(SHIFT)**, then press **(4)**(PLAY MODE) for two seconds.

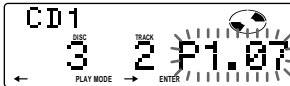

"P 1" shows Program 1 is selected.

If you have labelled the disc, the bank edit mode appears. Press **(4)**(PLAY MODE) to display "P 1" above.

To select Program 2, press **(5)**(→) repeatedly until "P 2" appears.

- 2 Press **(2)**(←) or **(5)**(→) to select the track you want to erase.

Track slot number

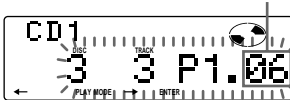

The track currently registered in slot 6 of Program 1.

- 3 Press **(6)**(ENTER) for two seconds. When you erase a track from a slot number, the succeeding tracks shift up to fill the gap.

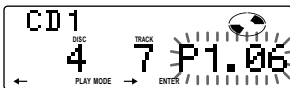

- 4 To continue erasing tracks, repeat steps 2 and 3.
- 5 When you finish erasing tracks, press **(4)**(PLAY MODE) for two seconds.
- 6 Press **(SHIFT)**.

Labeling a CD — Disc Memo (CD unit with the custom file function)

You can label each disc with a personalized name. You can enter up to eight characters for a disc. If you label a CD, you can locate the disc by name and select the specific tracks for playback (page 23).

- 1 Play the CD and press **(LIST)** for two seconds.

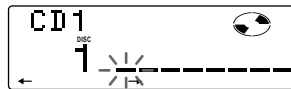

- 2 Enter the characters.

- 1 Rotate the dial clockwise to select the desired characters.
(A → B → C → ... Z → 0 → 1 → 2 → ... 9 → + → - → * → / → \ → > → < → . → _)

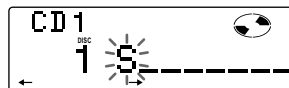

If you rotate the dial counterclockwise, the characters will appear in reverse order.

If you want to put a blank space between characters, select "_" (under-bar).

- 2 Press **(5)**(→) after locating the desired character. The flashing cursor moves to the next space.

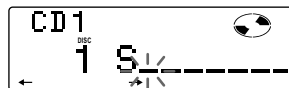

If you press **(2)**(←), the flashing cursor moves to the left.

- 3 Repeat steps 1 and 2 to enter the entire name.

- 3 To return to normal CD playback mode, press **(LIST)** for two seconds.

Tip

To erase or correct a name enter "_" (under-bar) for each character.

Displaying the disc memo name

Press **(DSPL)** during CD or CD TEXT disc playback.



Each time you press **(DSPL)** during CD or CD TEXT playback, the item changes as follows:

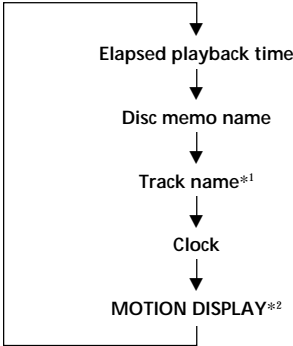

*1 If you connect an optional CD unit with the CD TEXT function, the CD TEXT information will appear in the display when you playback a CD TEXT disc.

*2 All the items above are scrolled in the display one by one in order.

Erasing the disc memo

- 1 Press **(SOURCE)** repeatedly to select CD.
- 2 Press **(MODE)** repeatedly to select the CD unit.
- 3 Press **(LIST)** for two seconds.
- 4 Press **(DSPL)** for two seconds.
- 5 Rotate the dial to select the name you want to erase.
- 6 Press **(ENTER)** for two seconds. The name is erased. Repeat steps 5 and 6 if you want to erase other names.
- 7 Press **(LIST)** for two seconds. The unit returns to normal CD playback mode.

Note

When the personalized label is erased, the original CD TEXT information will appear in the display.

Locating a disc by name

— List-up (CD unit with the custom file function or MD unit)

You can use this function for discs that have been assigned a custom name. For more information on disc names, refer to “Labeling a CD” (page 21).

- 1 Press **(LIST)** momentarily.
The name assigned to the current disc appears in the display.



When you assign a disc memo label to a CD TEXT disc, it takes priority over the original CD TEXT information.

- 2 Press **(LIST)** repeatedly until you find the desired disc.
- 3 Press **(6)**(ENTER) to play back the disc.

Notes

- After a disc name has been displayed for five seconds, the display goes back to normal playback mode. To turn off the display, press **(DSPL)**.
- The track names are not displayed during MD or CD TEXT disc playback.
- If there are no discs in the magazine, “NO Disc” appears in the display.
- If a disc has not been assigned a custom file, “*****” appears in the display.
- If the disc information has not been read by the unit, “?” appears in the display. To load a disc, first press the number button, then choose the disc that has not been loaded.
- The information appears only in upper case. There are also some letters which cannot be displayed (during MD or CD TEXT disc playback).

Selecting specific tracks for playback

— Bank
(CD unit with the custom file function)

If you label the disc, you can set the unit to skip tracks and play only the tracks you want.

- 1 Start playing the disc and press **(SHIFT)**. Then press **(4)** (PLAY MODE) for two seconds.

Bank edit mode.



Note

If you have not labeled the disc, the bank edit mode does not appear and the program edit mode appears. To go back to normal playback mode, press **(4)** (PLAY MODE) for two seconds.

- 2 Push the SEEK/AMS control up or down to select the track number you want to skip and press **(6)**(ENTER).



The indication changes from “Play” to “Skip.” To return the indication to “Play,” press **(6)**(ENTER) again.

- 3 Repeat step 2 to set “Play” or “Skip” mode for all the tracks.
- 4 Press **(4)**(PLAY MODE) for two seconds. The unit returns to normal CD playback mode.
- 5 Press **(SHIFT)**.

Notes

- You can set the “Play” and “Skip” mode for up to 24 tracks.
- You cannot set the “Skip” mode for all the tracks.

Playing the specific tracks only

You can select:

- Bank on – to play the tracks with the “Play” setting.
- Bank inv (Inverse) – to play the tracks with the “Skip” setting.

1 During playback, press **(SHIFT)**, then press **(4)** (PLAY MODE) repeatedly until “Bank” appears.

2 Press **(5)** (→) repeatedly until the desired setting appears.

→ Bank on → Bank inv → Bank off



Playback starts from the track following the current one.

3 Press **(SHIFT)**.

To return to normal play mode, select “Bank off” in step 2 above.

DSP

The optional XDP-U50D lets you add some effects to the sound field of the currently selected source.

Selecting a surround menu

You can select a desired surround menu to best fit the audio source. The following menus can simulate different sound fields and enhance the sound so that you feel as if you are in a live concert.

Surround menu

HALL	Concert hall
JAZZ	Jazz club
DISCO	Disco with thick walls
THEATER	Movie theater
PARK	Big open space
LIVE	Live concert
OPERA	Opera house
CHURCH	Church/chapel with a lot of reverberation
STADIUM	Open-air concert in a stadium
CELLAR	Cellar with a lot of reverberation
DEFEAT	Normal sound without any DSP effects

1 Press **(SOURCE)** to select a source (tuner, tape, CD, or MD).

2 Press **(SOUND)** repeatedly until “SUR” appears.

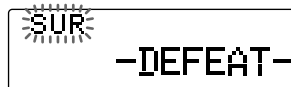

3 Rotate the dial to select the desired surround menu.

The surround menu appears in the order shown above.

After three seconds, the display returns to the normal playback mode.

Adjusting the effect level

- 1 Press **(SOURCE)** to select a source (tuner, tape, CD or MD).
- 2 Press **(SOUND)** for two seconds.

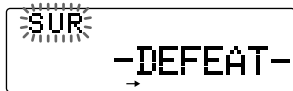

- 3 Rotate the dial to select until the desired surround menu appears.



- 4 Press **(5) (→)**.



- 5 Rotate the dial to adjust the level. You can adjust the level from 0 to 100%. Increase the level to enhance the effect.



- 6 Press **(SOUND)** for two seconds.

Storing a surround effect onto CDs

— Digital Signal Processor (DSP) Custom File (CD unit the with custom file function)

Once you have registered the desired surround menu onto the discs, you can enjoy the same surround menu every time you play them. (Only when you have labeled a disc by the Custom File function.)

- 1 Press **(LIST)** for two seconds.
- 2 Press **(LIST)** until the surround menu appears.
DSP custom file mode

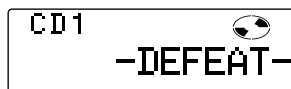

- 3 Rotate the dial to select the desired surround menu.
- 4 Press **(LIST)** for two seconds. After the effect setting is complete, the display returns to the normal playback mode.

Playing the disc with the stored surround menu

- 1 Press **(SHIFT)**, then press **(4) (PLAY MODE)** repeatedly until "D.File" appears.
- 2 Press **(5) (→)** to select "D.File on." After five seconds, the display returns to normal playback mode.
- 3 Press **(SHIFT)**.

To cancel to play the disc with stored surround menu, select "D.File off" in step 2 above.

Changing the stored surround effect

Play the disc whose surround mode you want to change, and follow the steps of "Storing the surround effect onto the CDs."

Erasing the stored surround effect

Select "DEFEAT" in step 3 of "Storing the surround effect onto the CDs."

Selecting the listening position

You can set a delayed time for the sound to reach the listeners from the speakers. In this way, the unit can simulate a natural sound field so that you feel as if you are in the center of the sound field no matter where you sit in the car.

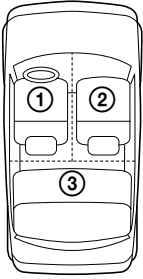

Display window	Center of sound field
LP1 All	Normal setting (① + ② + ③)
LP2 Front	Front part (① + ②)
LP3 Front R	Right front (②)
LP4 Front L	Left front (①)
LP5 Rear	Rear part (③)

EN

- 1 Press **(SOUND)** momentarily until "LP1" appears.



- 2 Rotate the dial to select the desired listening position.
The listening positions appear in the order shown above.

After three seconds, the display returns to the normal playback mode.

Adjusting the listening position

- 1 Press **(SOUND)** for two seconds.
- 2 Press **(SOUND)** repeatedly until the desired listening position appears.
- 3 Press **(5) (→)**.

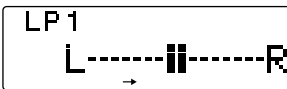

- 4 Rotate the dial to adjust the center of the sound field to the left or right. Then set the center of the sound field.



Center moves to the L (left).

Center moves to the R (right).

- 5 Press **(5) (→)**.

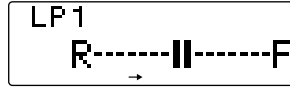

- 6 Rotate the dial to adjust the center of the sound field to the front or rear.



Center moves to the R (rear).

Center moves to the F (front).

- 7 Press **(SOUND)** for two seconds. When the effect setting is complete, the normal playback mode appears.

Adjusting the fader (FAD)

Normally, with the DSP mode on, the volume of the output sound from the rear speakers is lowered automatically to improve the efficiency of the listening position setting. If you want to raise the rear speaker volume, adjust the fader.

- 1 Follow steps 1 to 3 of "Selecting a surround menu" (page 24).
- 2 Press **(SOUND)** repeatedly until "FAD" appears.
- 3 Rotate the dial to adjust the fader.

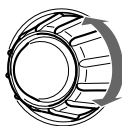

Decreases front speaker volume

Increases front speaker volume

After three seconds, the display returns to the normal playback mode.

Adjusting the volume of the subwoofer(s)

- 1 Press **(SOURCE)** to select a source (tuner, tape, CD, or MD).
- 2 Press **(SOUND)** repeatedly until "SUB" appears.
- 3 Rotate the dial to adjust the volume. After three seconds, the display returns to the normal playback mode.

Tip

When you rotate the dial to turn the volume all the way down, "Sub ATT" appears and the cut-off frequency of the subwoofer is disabled.

Adjusting the frequency of the subwoofer(s)

To match the characteristics of the connected subwoofer(s), you can cut out the unwanted high and middle frequency signals entering the subwoofer(s). By setting the cut-off frequency (see the diagram below), the subwoofer(s) will output only low frequency signals so you can get a clearer sound image.

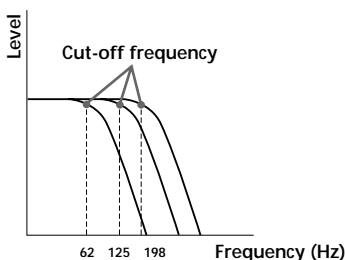

- 1 Press **(SOURCE)** to select a source (tuner, tape, CD, or MD).
- 2 Press **(SOUND)** for two seconds.
- 3 Press **(SOUND)** repeatedly until "SUB" appears.

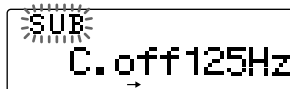

- 4 Rotate the dial to select the desired cut-off frequency. The cut-off frequency in the display changes as follows.

62 → 78 → 99 → 125* → 157 → 198 Hz

* Factory-set frequency

- 5 Press **(SOUND)** for two seconds. After the frequency setting is complete, the display returns to the normal playback mode.

Adjusting the volume of the bass and treble

You can adjust the volume of the bass and treble to best fit the acoustic characteristics inside your car.

- 1 Press **(SOURCE)** to select a source (tuner, tape, CD, or MD).
- 2 Press **(SOUND)** repeatedly until "BAS" or "TRE" appears.
- 3 Rotate the dial to adjust the volume. After three seconds, the display returns to the normal playback mode.

Adjusting the turn-over frequency

You can adjust the bass and treble turn-over frequencies.

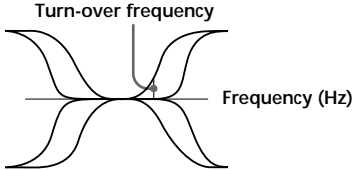

- 1 Press **(SOURCE)** to select a source (tuner, tape, CD, or MD).
- 2 Press **(SOUND)** for two seconds.
- 3 Press **(SOUND)** repeatedly until "BAS" or "TRE" appears.

Bass adjusting mode

BAS
→ 314 Hz

Treble adjusting mode

TRE
→ 3.1 kHz

- 4 Rotate the dial to select the turn-over frequency.

The turn-over frequencies change as follows:

Bass:

198 Hz → 250 Hz → 314 Hz* → 396 Hz

Treble:

2.0 kHz → 3.1 kHz* → 4.0 kHz → 5.0 kHz

* Factory-set frequency

- 5 Press **(SOUND)** for two seconds. The display returns to the normal playback mode.

Listening to each program source in its registered surround menu

— Last Sound Memory (LSM)

Each time you return to the same source, you can hear the same surround effect registered for that source, even after changing the program source or turning the unit off and then on again.

Changing the line output level

You can change the line output level if you hear distortion or other noise.

- 1 Press **(SHIFT)**, then press **(3)** (SET UP) until "L.out" appears.
- 2 Press **(5)** (→) to select the desired setting (-10 dB or -16 dB).
- 3 Press **(SHIFT)**.

TV/Video

You can connect an optional TV tuner and TV monitor to this unit.

Watching the TV

- 1 Press **(SOURCE)** repeatedly until "TV" appears.
- 2 Push the SEEK/AMS control up or down to select the desired TV band.

Watching a video

- 1 Press **(SOURCE)** repeatedly until "TV" appears.
- 2 Press **(MODE)** repeatedly to select "Video 1."
Play back the video.

Note
"Video 2" appears if the VIDEO 2 terminal of the TV monitor is selected.

Memorizing TV channels automatically

The unit selects the TV channels with the strongest signals and memorizes them in the order of their frequency.

Caution

When tuning in a station while driving, use Best Tuning Memory to prevent accidents.

- 1 Press **(SOURCE)** repeatedly until "TV" appears.
- 2 Press **(SHIFT)**, then press **(4)**(PLAY MODE) repeatedly until "Auto mem" appears.

- 3 Press **(5)** (→).
The unit stores TV channels in the order of their frequencies on the number buttons. The setting is stored with a beep sound.

- 4 Press **(SHIFT)**.

Notes

- The unit does not store TV channels with weak signals. If only a few TV channels can be received, some number buttons will remain empty.
- When a preset number is indicated in the display, the unit starts storing TV channels from the one currently displayed.

Memorizing only the desired TV channels

You can store up to 10 channels on the number buttons in the order of your choice.

- 1 Press **(SOURCE)** repeatedly until "TV" appears.
- 2 Push the SEEK/AMS control up or down to tune in the TV program you want to store on each number button.
- 3 Keep the desired number button (**(1)** to **(10)**) pressed until you hear a beep tone. The number button indication appears in the display.

Note

If you try to store another program on the same number button, the previously stored program will be erased.

EN

DSP/TV/Video

Storing the TV channel names

Follow the steps in "Storing the station names" (page 12).

Displaying the TV or radio station names

Press **(LIST)** momentarily during TV or radio reception.

Example: When receiving the FM1 band

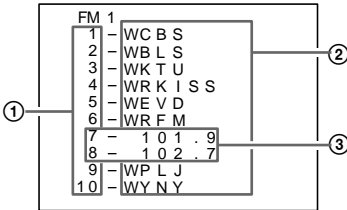

- ① Preset number
- ② Stored station names
- ③ Frequencies*

* If the name of a station is not stored, the frequency of that station will be displayed instead.

Notes

- It may take some time before all indications appear in the display.
- The TV program does not appear during list display.
- The contents of the preset memory cannot be listed when the unit is in the simultaneous play mode.

Turning off the display

During radio reception, press **(LIST)** again.

During TV reception, the list display on the TV monitor will automatically turn off after a few seconds.

Displaying the information stored on discs

Press **(LIST)** momentarily during CD/MD playback.

Example: When CD unit 1 is selected.

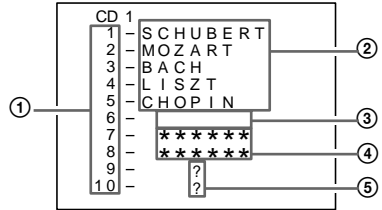

- ① Disc numbers
- ② Titles stored as custom files
- ③ No disc is loaded*¹
- ④ No stored titles*²
- ⑤ TOC information has not been identified yet*³

*¹ A blank space displayed next to a disc number represents empty slots in the disc magazine.

*² If a title is not registered in the custom file, "*****" is displayed.

*³ If the disc information has not been read yet, "?" is displayed.

Notes

- It may take some time until all indications appear in the display.
- The TV program does not appear during list display.
- The contents of the preset memory cannot be listed when the unit is in the simultaneous play mode.

Turning off the display

Press **(LIST)** again.

Watching the TV or video while listening to a tape, CD or MD — Simultaneous Play

The simultaneous play function does not work while you are listening to the radio.

- 1 Press **(SOURCE)** for two seconds.

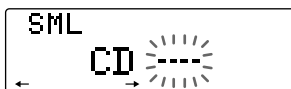

- 2 Press **(2) (←)**.



- 3 Press **(SOURCE)** repeatedly to select a tape, CD or MD.



- 4 Press **(5) (→)**.

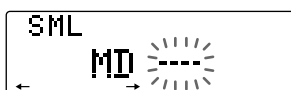

- 5 Press **(SOURCE)** repeatedly to select a TV or video.

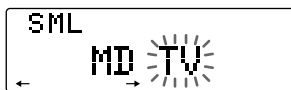

- 6 Press **(SOURCE)** for two seconds.
Simultaneous Play starts.

If you are already watching the TV or video and want to listen to a tape, CD, or MD with it, follow the same above steps except press **(5) (→)** in step 2 and press **(2) (←)** in step 4.

Returning to normal mode

To cancel the CD or MD, follow the steps above and select “- -” in step 3.

To cancel the TV or video, follow the steps above and select “- -” in step 5.

Notes

If you press the EJECT button on a CD/MD unit while the unit is in simultaneous play mode, Simultaneous Play is canceled.

Additional Information

Precautions

- If your car was parked in direct sunlight resulting in a considerable rise in temperature inside the car, allow the unit to cool off before operating it.
- If no power is being supplied to the unit, check the connections first. If everything is in order, check the fuse.
- If no sound comes from the speakers of a 2-speaker system, set the fader control to the center position.
- When the tape is played back for a long period, the cassette may become warm because of the built-in power amplifier. However, this is not a sign of malfunction.

EN

If you have any questions or problems concerning your unit that are not covered in this manual, please consult your nearest Sony dealer.

To maintain high quality sound

If you have drink holders near your audio equipment, be careful not to splash juice or other soft drinks onto the car audio. Sugary residues on this unit or cassette tapes may contaminate the playback heads, reduce the sound quality, or prevent sound reproduction altogether.

Cassette cleaning kits cannot remove sugar from the tape heads.



Notes on Cassettes

Cassette care

- Do not touch the tape surface of a cassette, as any dirt or dust will contaminate the heads.
- Keep cassettes away from equipment with built-in magnets such as speakers and amplifiers, as erasure or distortion on the recorded tape could occur.
- Do not expose cassettes to direct sunlight, extremely cold temperatures or moisture.
- Slack in the tape may cause the tape to be caught in the machine. Before you insert the tape, use a pencil or a similar object to turn the reel and take up any slack.

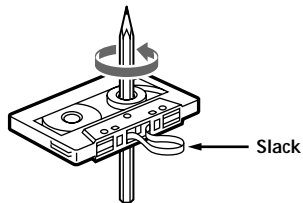

- Distorted cassettes and loose labels can cause problems when inserting or ejecting tapes. Remove or replace loose labels.



Cassettes longer than 90 minutes

The use of cassettes longer than 90 minutes is not recommended except for long continuous play. The tapes used for these cassettes are very thin and tend to be stretched easily. Frequent playing and stopping of these tapes may cause them to be pulled into the cassette deck mechanism.



Maintenance

Fuse Replacement

When replacing the fuse, be sure to use one matching the amperage rating stated on the original fuse. If the fuse blows, check the power connection and replace the fuse. If the fuse blows again after replacement, there may be an internal malfunction. In such a case, consult your nearest Sony dealer.

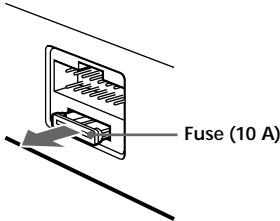

Warning

Never use a fuse with an amperage rating exceeding the one supplied with the unit as this could damage the unit.

Cleaning the Connectors

The unit may not function properly if the connectors between the unit and the front panel are not clean. In order to prevent this, open the front panel by pressing **OPEN**, then detach it and clean the connectors with a cotton swab dipped in alcohol. Do not apply too much force. Otherwise, the connectors may be damaged.

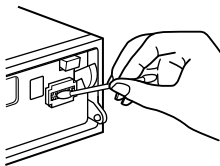

Main unit

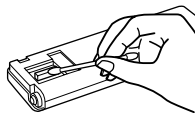

Back of the front panel

Notes

- For safety, before cleaning the connectors, turn off the engine and remove the key from the ignition switch.
- Never touch the connectors directly with your fingers or with any metal device.

Dismounting the unit

- 1 Press the clip inside the front cover with a thin screwdriver, and gently pry the front cover free.

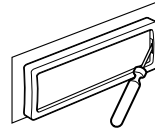

- 2 Repeat step 1 on the left side. The front cover is removed.

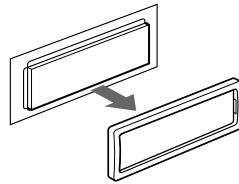

- 3 Use a thin screwdriver to push in the clip on the left side of the unit, then pull out the left side of the unit until the catch clears the mounting.

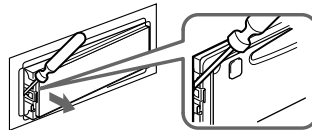

- 4 Repeat step 3 on the right side.

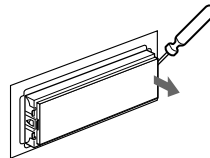

- 5 Slide the unit out of the mounting.

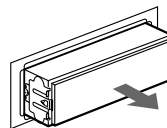

Specifications

AUDIO POWER SPECIFICATIONS

POWER OUTPUT AND TOTAL HARMONIC DISTORTION

19 watts per channel minimum continuous average power into 4 ohms, 4 channels driven from 20 Hz to 20 kHz with no more than 1 % total harmonic distortion.

Other specifications

Cassette player section

Tape track	4-track 2-channel stereo
Wow and flutter	0.08 % (WRMS)
Frequency response	30 – 20,000 Hz
Signal-to-noise ratio	

Cassette type	Dolby B NR	Dolby C NR	Dolby NR off
TYPE II, IV	67 dB	73 dB	61 dB
TYPE I	64 dB	70 dB	58 dB

Tuner section

FM

Tuning range	87.5 – 107.9 MHz
Antenna terminal	External antenna connector
Intermediate frequency	10.7 MHz
Usable sensitivity	8 dBf
Selectivity	75 dB at 400 kHz
Signal-to-noise ratio	65 dB (stereo), 68 dB (mono)
Harmonic distortion at 1 kHz	0.7 % (stereo), 0.4 % (mono)
Separation	35 dB at 1 kHz
Frequency response	30 – 15,000 Hz

AM

Tuning range	530 – 1,710 kHz
Antenna terminal	External antenna connector
Intermediate frequency	10.71 MHz/450 kHz
Sensitivity	30 μ V

Power amplifier section

Outputs	Speaker outputs (sure seal connectors)
Speaker impedance	4 – 8 ohms
Maximum power output	45 W \times 4 (at 4 ohms)

General

Outputs	Line outputs (2) Subwoofer output Power antenna relay control lead Power amplifier control lead Telephone ATT control lead Illumination control lead
Tone controls	Bass \pm 8 dB at 100 Hz Treble \pm 8 dB at 10 kHz
Power requirements	12 V DC car battery (negative ground)
Dimensions	Approx. 178 \times 50 \times 180 mm (7 ¹ / ₈ \times 2 \times 7 ¹ / ₈ in.) (w/h/d)
Mounting dimensions	Approx. 182 \times 53 \times 160 mm (7 ¹ / ₄ \times 2 ¹ / ₈ \times 6 ³ / ₈ in.) (w/h/d)
Mass	Approx. 1.5 kg
Supplied accessories	Rotary commander (1) Parts for installation and connections (1 set) Front panel case (1) BUS cable (supplied with an RCA pin cord) RC-61 (1 m), RC-62 (2 m) Wireless remote RM-X47 (1)
Optional accessories	CD changer CDX-805 (10 discs), CDX-715 (10 discs), CDX-T65 (6 discs), CDX-T62 (6 discs) MD changer MDX-62 Digital preamplifier XDP-210EQ, etc Source selector XA-C30 TV tuner XT-40V, etc
Optional equipment	

Design and specifications are subject to change without notice.

Troubleshooting guide

The following checklist will help you remedy the problems you may encounter with your unit. Before going through the checklist below, check the connection and operating procedures.

General

Problem	Cause/Solution
No sound.	<ul style="list-style-type: none">• Cancel the ATT function.• Set the fader control to the center position for two-speaker systems.• Rotate the dial in a clockwise direction to adjust the volume.
The contents of the memory have been erased.	<ul style="list-style-type: none">• The power cord or battery has been disconnected.• The reset button has been pressed. → Store again into the memory.
Indications do not appear in the display.	Remove the front panel and clean the connectors. See “Cleaning the connectors” (page 33) for details.

Tape playback

Problem	Cause/Solution
Playback sound is distorted.	Contamination of the tape head. → Clean the head.
The AMS does not operate correctly.	<ul style="list-style-type: none">• There is noise in the space between tracks.• The blank space is too short (less than four seconds).• ►► on the SEEK/AMS control is pressed immediately before the following tracks.• ◀◀ on the SEEK/AMS control is pressed immediately after the track starts.• A long pause, or a passage of low frequencies or very low sound level is treated as a blank space.

Radio reception

Problem	Cause/Solution
Preset tuning is not possible.	<ul style="list-style-type: none">• Memorize the correct frequency.• The broadcast signal is too weak.
Automatic tuning is not possible.	The broadcast signal is too weak. → Use manual tuning.
The “ST” indication flashes.	<ul style="list-style-type: none">• Tune in the frequency accurately.• The broadcast signal is too weak. → Set to MONO mode (page 11).
Interference occurs during FM reception.	The Wide mode is selected. → Set to the Narrow or IF Auto mode. (page 11)

DSP functions

Problem	Cause/Solution
No sound, or the sound is too low.	The volume of the rear speakers may have been automatically lowered in order to maximize the effect of the listening position adjustment. → Rotate the dial in a clockwise direction to adjust the balance. The speaker balance can be set separately for DSP on mode and DSP off mode (page 26).

Error displays (when an optional CD/MD unit is connected)

The following indications will flash for about five seconds, and an alarm sound will be heard.

Display	Cause	Solution
NO Mag	The disc magazine is not inserted in the CD/MD unit.	Insert the disc magazine in the CD/MD unit.
NO Disc	No disc is inserted in the CD/MD unit.	Insert discs in the CD/MD unit.
NG Discs	A CD/MD cannot play because of some problem.	Insert another CD/MD.
Error* ¹	A CD is dirty or inserted upside down.* ²	Clean or insert the CD correctly.
	An MD does not play because of some problem.* ²	Insert another MD.
Blank* ¹	No tracks have been recorded on an MD.* ²	Play an MD with tracks recorded on it.
PushReset	The CD/MD unit cannot be operated because of some problem.	Press the reset button of the unit.
Not Ready	The lid of the MD unit is open or MDs are not inserted properly.	Close the lid or insert the MDs properly.
HighTemp	The ambient temperature is more than 50°C (122°F).	Wait until the temperature goes down below 50°C (122°F).

*¹ When an error occurs during playback of a CD or MD, the disc number of the CD or MD does not appear in the display.

*² The disc number of the disc causing the error appears in the display.

If the above-mentioned solutions do not help improve the situation, consult your nearest Sony dealer.

