

SONY®

2-651-444-11(1)

CD/DVD Player

Operating Instructions



DVP-NS29

© 2005 Sony Corporation

WARNING

To reduce the risk of fire or electric shock, do not expose this apparatus to rain or moisture.

To avoid electrical shock, do not open the cabinet. Refer servicing to qualified personnel only.

The mains lead must only be changed at a qualified service shop.

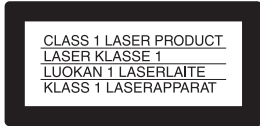

This appliance is classified as a CLASS 1 LASER product. The CLASS 1 LASER PRODUCT MARKING is located on the rear exterior.

CAUTION

The use of optical instruments with this product will increase eye hazard. As the laser beam used in this CD/DVD player is harmful to eyes, do not attempt to disassemble the cabinet.

Refer servicing to qualified personnel only.

Notice for customers in the United Kingdom and Republic of Ireland

A moulded plug complying with BS1363 is fitted to this equipment for your safety and convenience. Should the fuse in the plug supplied need to be replaced, a 5AMP fuse approved by ASTA or BSI to BS1362, (i.e., marked with ⚡ or ⚡ mark) must be used. If the plug supplied with this equipment has a detachable fuse cover, be sure to attach the fuse cover after you change the fuse. Never use the plug without the fuse cover. If you should lose the fuse cover, please contact your nearest Sony service station.



Disposal of Old Electrical & Electronic Equipment (Applicable in the European Union and other European countries with separate collection systems)

This symbol on the product or on its packaging indicates that this product shall not be treated as household waste. Instead it shall be handed over to the applicable collection point for the recycling of electrical and electronic equipment. By ensuring this product is disposed of correctly, you will help prevent potential negative consequences for the environment and human health, which could otherwise be caused by inappropriate waste handling of this product. The recycling of materials will help to conserve natural resources. For more detailed information about recycling of this product, please contact your local Civic Office, your household waste disposal service or the shop where you purchased the product.

Precautions

Safety

- This unit operates on 220 – 240 V AC, 50/60 Hz. Check that the unit's operating voltage is identical with your local power supply.
- To prevent fire or shock hazard, do not place objects filled with liquids, such as vases, on the apparatus.

Installing

- Do not install the unit in an inclined position. It is designed to be operated in a horizontal position only.
- Keep the unit and discs away from equipment with strong magnet, such as microwave ovens, or large loudspeakers.
- Do not place heavy objects on the unit.

Notes About the Discs

- To keep the disc clean, handle the disc by its edge. Do not touch the surface.



- Do not expose the disc to direct sunlight or heat sources such as hot air ducts, or leave it in a car parked in direct sunlight as the temperature may rise considerably inside the car.
- After playing, store the disc in its case.
- Clean the disc with a cleaning cloth. Wipe the disc from the centre out.



- Do not use solvents such as benzene, thinner, commercially available disc/lens cleaners, or anti-static spray intended for vinyl LPs.
- If you have printed the disc's label, dry the label before playing.

Precautions

On safety

Should any solid object or liquid fall into the cabinet, unplug the player and have it checked by qualified personnel before operating it any further.

On power sources

- The player is not disconnected from the AC power source (mains) as long as it is connected to the wall outlet, even if the player itself has been turned off.
- If you are not going to use the player for a long time, be sure to disconnect the player from the wall outlet. To disconnect the AC power cord (mains lead), grasp the plug itself; never pull the cord.

On placement

- Place the player in a location with adequate ventilation to prevent heat build-up in the player.
- Do not place the player on a soft surface such as a rug.
- Do not place the player in a location near heat sources, or in a place subject to direct sunlight, excessive dust, or mechanical shock.

On operation

- If the player is brought directly from a cold to a warm location, or is placed in a very damp room, moisture may condense on the lenses inside the player. Should this occur, the player may not operate properly. In this case, remove the disc and leave the player turned on for about half an hour until the moisture evaporates.
- When you move the player, take out any discs. If you don't, the disc may be damaged.

On adjusting volume

Do not turn up the volume while listening to a section with very low level inputs or no audio signals. If you do, the speakers may be damaged when a peak level section is played.

On cleaning

Clean the cabinet, panel, and controls with a soft cloth slightly moistened with a mild detergent solution. Do not use any type of abrasive pad, scouring powder or solvent such as alcohol or benzine.

On cleaning discs, disc/lens cleaners

Do not use a commercially available cleaning disc or disc/lens cleaner (wet or spray type). These may cause the apparatus to malfunction.

IMPORTANT NOTICE

Caution: This player is capable of holding a still video image or on-screen display image on your television screen indefinitely. If you leave the still video image or on-screen display image displayed on your TV for an extended period of time you risk permanent damage to your television screen. Plasma display panel televisions and projection televisions are susceptible to this.

If you have any questions or problems concerning your player, please consult your nearest Sony dealer.

Table of Contents

WARNING	2
Notes About the Discs	2
Precautions	3
About This Manual	5
This Player Can Play the Following Discs	6
Index to Parts and Controls	8
Guide to the Control Menu Display (Magic Pad)	11
<hr/>	
Hookups	14
Hooking Up the Player	14
Step 1: Unpacking	14
Step 2: Inserting Batteries Into the Remote	14
Step 3: Connecting the Video Cords	15
Step 4: Connecting the Audio Cords	17
Step 5: Connecting the Mains Lead	19
Step 6: Quick Setup	19
<hr/>	
Playing Discs	21
Playing Discs	21
Resuming Playback from the Point Where You Stopped the Disc (Resume Play)	23
Using the DVD's Menu	24
Selecting "ORIGINAL" or "PLAY LIST" on a DVD-RW	24
Playing VIDEO CDs With PBC Functions (PBC Playback)	25
Various Play Mode Functions (Programme Play, Shuffle Play, Repeat Play, A-B Repeat Play)	26
<hr/>	
Searching for a Scene	30
Searching for a Particular Point on a Disc (Search, Scan, Slow-motion Play, Freeze Frame)	30
Searching for a Title/Chapter/Track/Scene, etc.	31
Searching by Scene (PICTURE NAVIGATION)	33
<hr/>	
Viewing Information About the Disc	34
Checking the Playing Time and Remaining Time	34
<hr/>	
Sound Adjustments	37
Changing the Sound	37
TV Virtual Surround Settings (TVS)	38
<hr/>	
Enjoying Movies	40
Changing the Angles	40
Displaying the Subtitles	40
Adjusting the Playback Picture (CUSTOM PICTURE MODE)	41
Sharpening the Pictures (SHARPNESS)	43

Enjoying MP3 Audio and JPEG Images	44
About MP3 Audio Tracks and JPEG Image Files	44
Playing MP3 Audio Tracks or JPEG Image Files	45
Enjoying JPEG Images as a Slide Show	48
Using Various Additional Functions	51
Locking Discs (CUSTOM PARENTAL CONTROL, PARENTAL CONTROL)	51
Controlling Your TV With the Supplied Remote	54
Settings and Adjustments	55
Using the Setup Display	55
Setting the Display or Sound Track Language (LANGUAGE SETUP)	56
Settings for the Display (SCREEN SETUP)	57
Custom Settings (CUSTOM SETUP)	58
Settings for the Sound (AUDIO SETUP)	59
Additional Information	61
Troubleshooting	61
Self-diagnosis Function (When letters/numbers appear in the display)	64
Glossary	64
Specifications	66
Language Code List	67
Index	68

About This Manual

- Instructions in this manual describe the controls on the remote. You can also use the controls on the player if they have the same or similar names as those on the remote.
- “DVD” may be used as a general term for DVD VIDEOS, DVD+RWs/DVD+Rs and DVD-RWs/DVD-Rs.
- The meaning of the icons used in this manual is described below:

Icons	Meanings
DVD-V	Functions available for DVD VIDEOS and DVD+RWs/DVD+Rs in +VR mode or DVD-RWs/DVD-Rs in video mode
DVD-RW	Functions available for DVD-RWs in VR (Video Recording) mode
VCD	Functions available for VIDEO CDs (including Super VCDs or CD-Rs/CD-RWs in video CD format or Super VCD format)
CD	Functions available for music CDs or CD-Rs/CD-RWs in music CD format
DATA CD	Functions available for DATA CDs (CD-ROMs/CD-Rs/CD-RWs containing MP3*1 audio tracks and JPEG image files)
DATA DVD	Functions available for DATA DVDs (DVD-ROMs/DVD+RWs/DVD+Rs/DVD-RWs/DVD-Rs) containing MP3*1 audio tracks and JPEG image files.

*1 MP3 (MPEG-1 Audio Layer III) is a standard format defined by ISO (International Organization for Standardization)/IEC (International Electrotechnical Commission) MPEG which compresses audio data.

This Player Can Play the Following Discs

Format of discs	
DVD VIDEO	
DVD-RW/-R	
DVD+RW/+R	
VIDEO CD Music CD	
CD-RW/-R	

“DVD+RW,” “DVD-RW,” “DVD+R,” “DVD-Video” and the “CD” logo are trademarks.

Note about CDs/DVDs

The player can play CD-ROMs/CD-Rs/CD-RWs recorded in the following formats:

- music CD format
- video CD format
- MP3 audio tracks and JPEG image files of format conforming to ISO 9660* Level 1/ Level 2, or its extended format, Joliet
- KODAK Picture CD format

* A logical format of files and folders on CD-ROMs, defined by ISO (International Organization for Standardization).

The player can play DVD-ROMs/ DVD+RWs/DVD-RWs/DVD+Rs/DVD-Rs recorded in the following formats:

- MP3 audio tracks and JPEG image files of format conforming to UDF (Universal Disk Format).

Example of discs that the player cannot play

The player cannot play the following discs:

- CD-ROMs/CD-Rs/CD-RWs other than those recorded in the formats listed on this page.
- CD-ROMs recorded in PHOTO CD format.
- Data part of CD-Extras.
- DVD Audios.
- HD layer on Super Audio CDs.

Also, the player cannot play the following discs:

- A DVD VIDEO with a different region code.
- A disc that has a non-standard shape (e.g., card, heart).
- A disc with paper or stickers on it.
- A disc that has the adhesive of cellophane tape or a sticker still left on it.

Region code

Your player has a region code printed on the back of the unit and only will play DVD VIDEOS (playback only) labelled with identical region codes. This system is used to protect copyrights.

DVD VIDEOS labelled  will also play on this player.

If you try to play any other DVD VIDEO, the message “Playback prohibited by area limitations.” will appear on the TV screen. Depending on the DVD VIDEO, there may be no region code indication, even though playing the DVD VIDEO is prohibited by area restrictions.

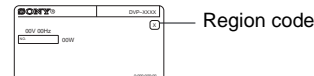

Notes

- **Notes about DVD+RWs/DVD+Rs, DVD-RWs/DVD-Rs or CD-Rs/CD-RWs**

Some DVD+RWs/DVD+Rs, DVD-RWs/DVD-Rs, or CD-Rs/CD-RWs cannot be played on this player due to the recording quality or physical condition of the disc, or the characteristics of the recording device and authoring software.

The disc will not play if it has not been correctly finalized. For more information, refer to the operating instructions for the recording device. Note that some playback functions may not work with some DVD+RWs/DVD+Rs, even if they have been correctly finalized. In this case, view the disc by normal playback. Also some DATA CDs/DATA DVDs created in Packet Write format cannot be played.

- **Music discs encoded with copyright protection technologies**

This product is designed to playback discs that conform to the Compact Disc (CD) standard. Recently, various music discs encoded with copyright protection technologies are marketed by some record companies. Please be aware that among those discs, there are some that do not conform to the CD standard and may not be playable by this product.

- **Note on DualDiscs**

A DualDisc is a two sided disc product which mates DVD recorded material on one side with digital audio material on the other side.

However, since the audio material side does not conform to the Compact Disc (CD) standard, playback on this product is not guaranteed.

Copyrights

This product incorporates copyright protection technology that is protected by U.S. patents and other intellectual property rights. Use of this copyright protection technology must be authorized by Macrovision, and is intended for home and other limited viewing uses only unless otherwise authorized by Macrovision. Reverse engineering or disassembly is prohibited.

Note on playback operations of DVDs and VIDEO CDs



Some playback operations of DVDs and VIDEO CDs may be intentionally set by software producers. Since this player plays DVDs and VIDEO CDs according to the disc contents the software producers designed, some playback features may not be available. Also, refer to the instructions supplied with the DVDs or VIDEO CDs.

Index to Parts and Controls

For more information, see the pages indicated in parentheses.

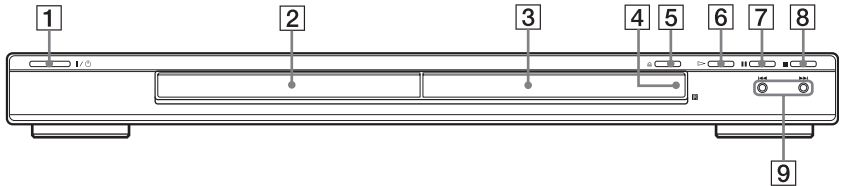
Front panel



- | | |
|---|--|
| 1 I/O (on/standby) button (21) | 6 ▷ (play) button (21) |
| 2 Disc tray (21) | 7 (pause) button (22) |
| 3 Front panel display (9) | 8 ■ (stop) button (22) |
| 4  (remote sensor) (14) | 9 ◀▶ (previous/next) buttons (30) |
| 5  (open/close) button (21) | |

Rear panel

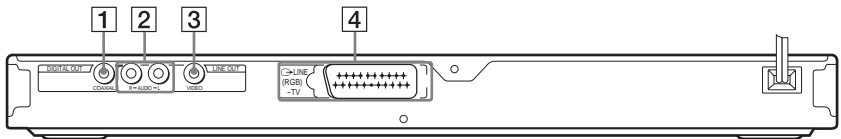

- | | |
|--|-------------------------------------|
| 1 DIGITAL OUT (COAXIAL) jack (17) | 3 LINE OUT (VIDEO) jack (15) |
| 2 LINE OUT L/R (AUDIO) jacks (17) | 4 LINE (RGB) - TV jack (15) |

Front panel display

When playing back a DVD VIDEO/DVD-RW

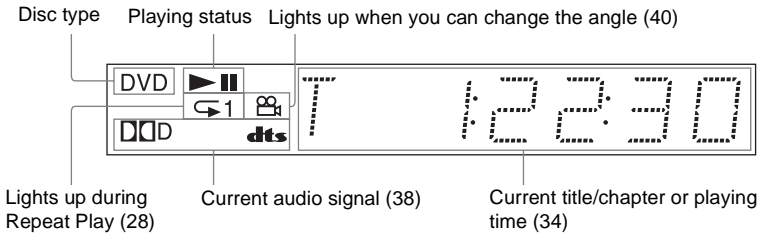

When playing back a VIDEO CD with Playback Control (PBC) (25)

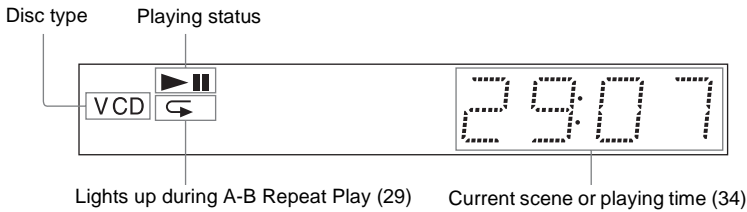

When playing back a CD, DATA DVD (MP3 audio), DATA CD (MP3 audio), or VIDEO CD (without PBC)

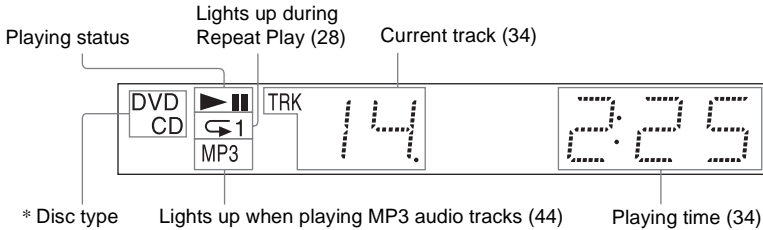

* When playing DATA DVDs, the DVD indicator is displayed.

Remote

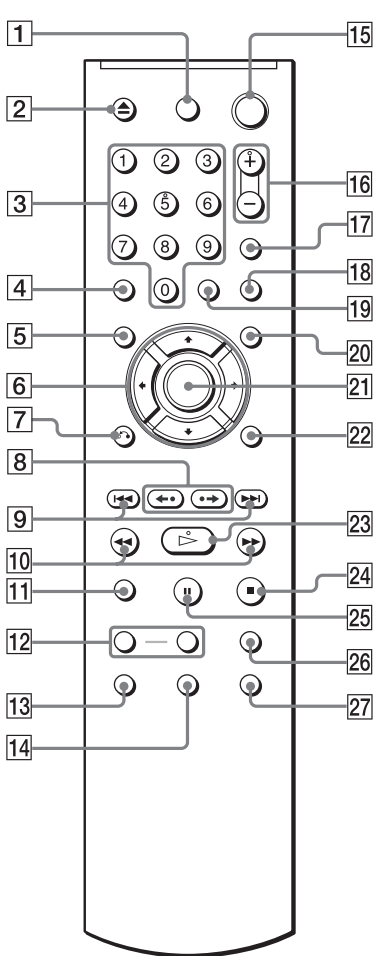

- 10** ⏮/⏭ (scan/slow) buttons (31)
- 11** ZOOM button (22, 47)
- 12** SLOW PLAY/FAST PLAY buttons (22)
- 13** 🔊 (audio) button (37)
- 14** ⋮ (subtitle) button (40)
- 15** I/⏻ (on/standby) button (21)
- 16** ▲/▼ (volume) +/- buttons (54)
The + button has a tactile dot.*
- 17** ↶ (TV/video) button (54)
- 18** PICTURE NAVI (picture navigation) button (33, 47)
- 19** TIME/TEXT button (34)
- 20** MENU button (24)
- 21** ENTER button (19)
- 22** DISPLAY button (11)
- 23** ▷ (play) button (21)
The ▷ button has a tactile dot.*
- 24** ■ (stop) button (22)
- 25** ⏸ (pause) button (22)
- 26** SUR (surround) button (38)
- 27** 🔊 (angle) button (40)

* Use the tactile dot as a reference when operating the player.

- 1** TV I/⏻ (on/standby) button (54)
- 2** ▲ (open/close) button (22)
- 3** Number buttons (24)
The number 5 button has a tactile dot.*
- 4** CLEAR button (26)
- 5** TOP MENU button (24)
- 6** ←/↑/↓/→ buttons (24)
- 7** ↶ RETURN (return) button (22)
- 8** ◀/▶/⏮/⏭ (replay/step/advance/step) buttons (22, 31)
- 9** ⏮/⏭ (previous/next) buttons (22)

Guide to the Control Menu Display (Magic Pad)

Use the Control Menu to select a function and to view related information. Press DISPLAY repeatedly to turn on or change the Control Menu display as follows:

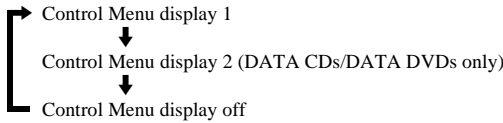

Control Menu display

The Control Menu display 1 and 2 will show different items depending on the disc type. For details about each item, see the pages in parentheses.

Example: Control Menu display 1 when playing a DVD VIDEO.

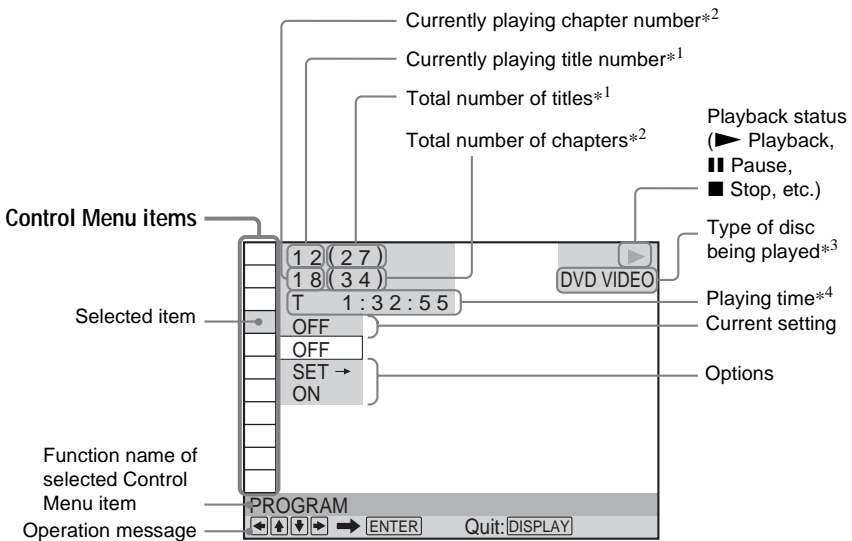

*1 Displays the scene number for VIDEO CDs (PBC is on), track number for VIDEO CDs/CDs, album number for DATA DVDs/DATA CDs.

*2 Displays the index number for VIDEO CDs, MP3 audio track number or JPEG image file number for DATA CDs/DATA DVDs.



















*3 Displays Super VCD as "SVCD."

*4 Displays the date for JPEG files.

To turn off the display

Press DISPLAY.

List of Control Menu items

Item	Item Name, Function
	TITLE (page 31)/SCENE (page 32)/TRACK (page 31) Selects the title, scene, or track to be played.
	CHAPTER (page 31)/INDEX (page 31) Selects the chapter or index to be played.
	TRACK (page 32) Selects the track to be played.
	ORIGINAL/PLAY LIST (page 24) Selects the type of titles (DVD-RW) to be played, the ORIGINAL one, or an edited PLAY LIST.
	TIME/TEXT (page 31) Checks the elapsed time and the remaining playback time. Input the time code for picture and music searching. Displays the DVD/CD text, or the DATA CD/DATA DVD track/file name.
	PROGRAM (page 26) Selects the title, chapter, or track to play in the order you want.
	SHUFFLE (page 27) Plays the title, chapter, or track in random order.
	REPEAT (page 28) Plays the entire disc (all titles/all tracks/all albums) repeatedly or one title/chapter/track/album repeatedly.
	A-B REPEAT (page 29) Specifies the parts you want to play repeatedly.
	CUSTOM PICTURE MODE (page 41) Adjusts the video signal from the player. You can select the picture quality that best suits the program you are watching.
	SHARPNESS (page 43) Exaggerates the outline of the image to produce a sharper picture.
	PARENTAL CONTROL (page 51) Set to prohibit playback on this player.
	SETUP (page 55) QUICK Setup (page 19) Use Quick Setup to choose the desired language of the on-screen display, the aspect ratio of the TV, and the audio output signal. CUSTOM Setup In addition to the Quick Setup setting, you can adjust various other settings. RESET Returns the settings in "SETUP" to the default setting.
	ALBUM (page 32) Selects the album that contain JPEG image file to be played.
	FILE (page 32) Selects the JPEG image file to be played.
	DATE (page 47) Displays the date the picture was taken by a digital camera.
	INTERVAL (page 49) Specifies the duration for which the slides are displayed on the screen.
	EFFECT (page 50) Selects the effects to be used for changing slides during a slide show.





MODE (MP3, JPEG) (page 48)

Selects the data type; MP3 audio track (AUDIO), JPEG image file (IMAGE) or both (AUTO) to be played when playing a DATA CD/DATA DVD.

Hint

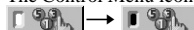
The Control Menu icon indicator lights up in green



→  when you select any item except "OFF." ("PROGRAM," "SHUFFLE," "REPEAT," "A-B REPEAT," "SHARPNESS," "CUSTOM PICTURE MODE" only). The "ORIGINAL/PLAY LIST" indicator lights up in green when you select "PLAY LIST" (default setting).

Hooking Up the Player

Follow steps 1 to 6 to hook up and adjust the settings of the player.

Notes

- Plug cords securely to prevent unwanted noise.
- Refer to the instructions supplied with the components to be connected.
- You cannot connect this player to a TV that does not have a SCART or video input jack.
- Be sure to disconnect the mains lead of each component before connecting.

Step 1: Unpacking

Check that you have the following items:

- Remote commander (remote) (1)
- R6 (size AA) batteries (2)

Step 2: Inserting Batteries Into the Remote

You can control the player using the supplied remote. Insert two R6 (size AA) batteries by matching the ⊕ and ⊖ ends on the batteries to the markings inside the compartment. When using the remote, point it at the remote sensor  on the player.

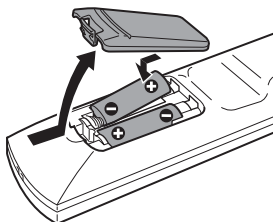

Notes

- Do not leave the remote in an extremely hot or humid place.
- Do not drop any foreign object into the remote casing, particularly when replacing the batteries.
- Do not expose the remote sensor to direct light from the sun or a lighting apparatus. Doing so may cause a malfunction.
- If you do not use the remote for an extended period of time, remove the batteries to avoid possible damage from battery leakage and corrosion.

Step 3: Connecting the Video Cords

Connect this player to your TV monitor, projector, or AV amplifier (receiver) using a video cord. Select one of the patterns **A** or **B**, according to the input jack on your TV monitor, projector, or AV amplifier (receiver).

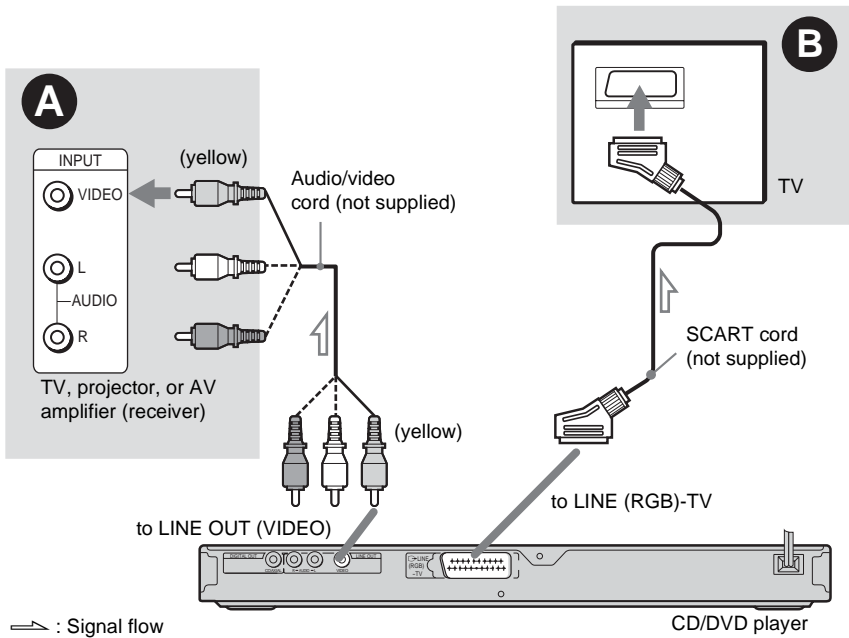

A If you are connecting to a video input jack

Connect the yellow plug of an audio/video cord (not supplied) to the yellow (video) jack. You will enjoy standard quality images.



B If you are connecting to a SCART input jack

Connect a SCART cord (not supplied). Be sure to make the connections firmly to avoid hum and noise. When you connect using the SCART cord, check that the TV conforms to S video or RGB signals. Refer to the operating instructions supplied with the TV to be connected. Also, when you set "LINE" to "S VIDEO" or "RGB" under "SCREEN SETUP" in the Setup Display (page 57), use a SCART cord that conforms to each signal.





When connecting to a wide screen TV

Depending on the disc, the image may not fit your TV screen. To change the aspect ratio, see page 57.

Notes

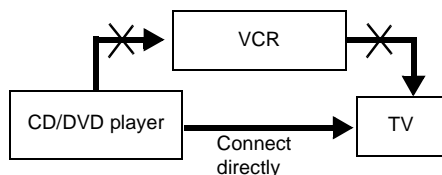
- Do not connect a VCR, etc., between your TV and the player. If you pass the player signals via the VCR, you may not receive a clear image on the TV screen. If your TV has only one audio/video input jack, connect the player to this jack.



- When you connect the player to your TV via the SCART jacks, the TV's input source is set to the player automatically when you start playback. In this case, press  (TV/video) on the remote to return the input to the TV.

When you play a disc recorded in the NTSC colour system, the player outputs the video signal or the Setup Display etc. in the NTSC colour system and the picture may not appear on the PAL colour system televisions. In this case, open the tray and remove the disc.

Step 4: Connecting the Audio Cords

Select one of the following patterns **A** or **B**, according to the input jack on your TV monitor, projector, or AV amplifier (receiver). This will enable you to listen to sound.

A

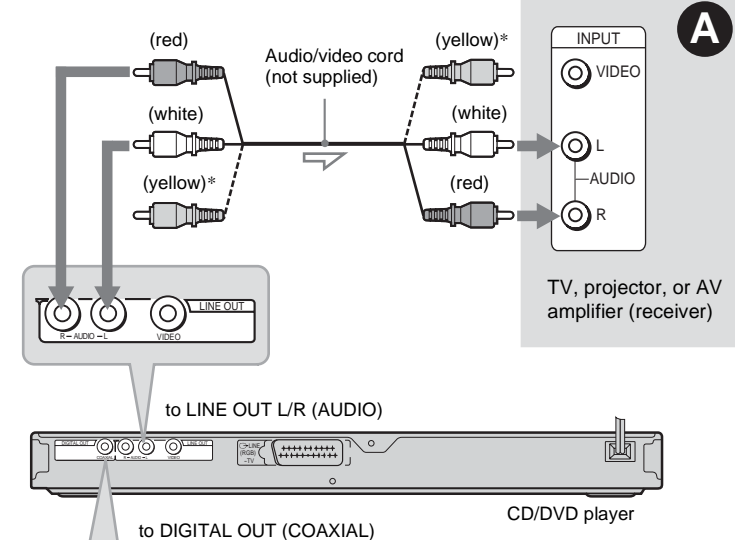

B

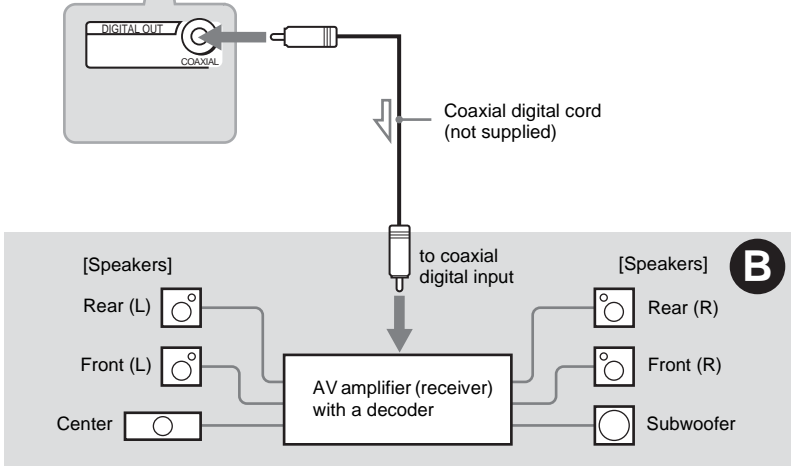

: Signal flow

* The yellow plug is used for video signals (page 15).

Hint

For correct speaker location, see the operating instructions supplied with the connected components.

A Connecting to audio L/R input jacks

This connection will use your TV's or stereo amplifier's (receiver's) two speakers for sound. Connect using the audio/video cord (not supplied).

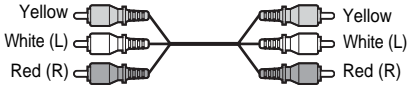

- Surround effect (page 38)
TV: Dynamic Theatre, Dynamic, Wide, Night



Stereo amplifier (receiver): Standard, Night

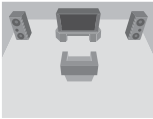

B Connecting to a digital audio input jack

If your AV amplifier (receiver) has a Dolby^{*1} Digital, DTS^{*2} or MPEG audio decoder and a digital input jack, use this connection. Connect using a coaxial digital cord (not supplied).



- Surround effect
Dolby Digital (5.1ch), DTS (5.1ch), MPEG audio (5.1ch)

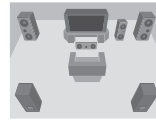

^{*1} Manufactured under license from Dolby Laboratories.

"Dolby," "Pro Logic," and the double-D symbol are trademarks of Dolby Laboratories.

^{*2} "DTS" and "DTS Digital Out" are trademarks of Digital Theater Systems, Inc.

Notes

- After you have completed the connection, make the appropriate settings in Quick Setup (page 19). If your AV amplifier (receiver) has an MPEG audio decoder function, set "MPEG" to "MPEG" in Audio Setup (page 60). Otherwise, no sound or a loud noise will come from your speakers.
- The surround sound effects of this player cannot be used with this connection.
- In order to listen to DTS sound tracks, you must use this connection. DTS sound tracks are not output through the LINE OUT L/R (AUDIO) jacks, even if you set "DTS" to "ON" in Quick Setup (page 19).

Step 5: Connecting the Mains Lead

Plug the player and TV mains lead (power cord) into a mains.

Step 6: Quick Setup

Follow the steps below to make the minimum number of basic adjustments for using the player. To skip an adjustment, press ►►. To return to the previous adjustment, press ◀◀.

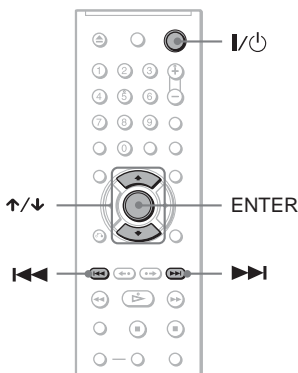

- 1 Turn on the TV.
- 2 Press I/O.
- 3 Switch the input selector on your TV so that the signal from the player appears on the TV screen.

“Press [ENTER] to run QUICK SETUP” (press enter to run Quick Setup) appears at the bottom of the screen. If this message does not appear, select “QUICK” (quick) under “SETUP” (setup) in the Control Menu to run Quick Setup (page 56).

- 4 Press ENTER without inserting a disc.

The Setup Display for selecting the language used in the on-screen display appears.

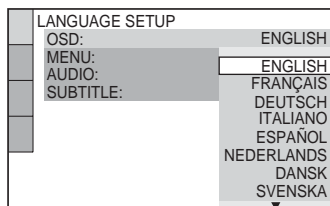

- 5 Press ↑/↓ to select a language.

The player displays the menu and subtitles in the selected language.

- 6 Press ENTER.

The Setup Display for selecting the aspect ratio of the TV to be connected appears.

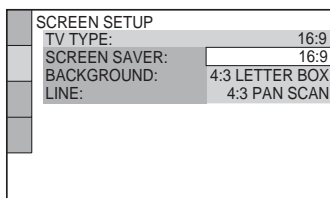

7 Press \uparrow/\downarrow to select the setting that matches your TV type.

- ◆ If you have a wide-screen TV or a 4:3 standard TV with a wide-screen mode
 - 16:9 (page 57)
- ◆ If you have a 4:3 standard TV
 - 4:3 LETTER BOX or 4:3 PAN SCAN (page 57)

8 Press ENTER.

The Setup Display for selecting the type of video signal output from the LINE (RGB)-TV jack appears.

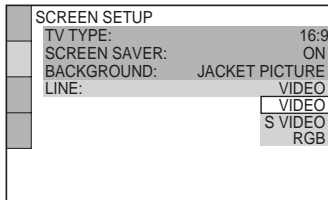

9 Press \uparrow/\downarrow to select the type of signal you want to output from the LINE (RGB)-TV jack.

- ◆ Video signals
 - VIDEO (page 57)
- ◆ S video signals
 - S VIDEO (page 57)
- ◆ RGB signals
 - RGB (page 57)

10 Press ENTER.

The Setup Display for selecting the type of jack used to connect your amplifier (receiver) appears.

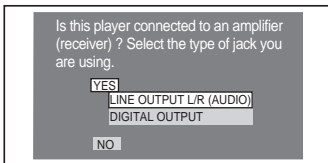

11 Press \uparrow/\downarrow to select the type of jack (if any) you are using to connect to an amplifier (receiver), then press ENTER.

If you did not connect an AV amplifier (receiver), select “NO,” then go to step 15.

If you connected an AV amplifier (receiver) using just an audio cord, select “YES: LINE OUTPUT L/R (AUDIO),” then go to step 15.

If you connected an AV amplifier (receiver) using a coaxial digital cord, select “YES: DIGITAL OUTPUT.”

12 Press \uparrow/\downarrow to select the type of Dolby Digital signal you wish to send to your amplifier (receiver).

If your AV amplifier (receiver) has a Dolby Digital decoder, select “DOLBY DIGITAL.” Otherwise, select “D-PCM.”

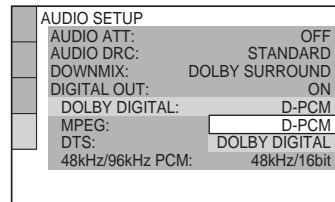

13 Press ENTER.

“DTS” is selected.

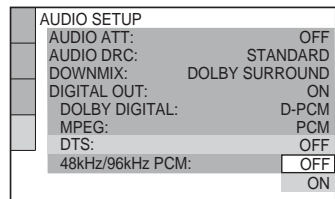

14 Press \uparrow/\downarrow to select whether or not you wish to send a DTS signal to your amplifier (receiver).

If your AV amplifier (receiver) has a DTS decoder, select “ON.” Otherwise, select “OFF.”

15 Press ENTER.

Quick Setup is finished. All connections and setup operations are complete.

If your AV amplifier (receiver) has an MPEG audio decoder, set “MPEG” to “MPEG” (page 60).

Playing Discs

Playing Discs DVD-V

DVD-RW VCD CD DATA CD

DATA DVD

Depending on the DVD or VIDEO CD, some operations may be different or restricted. Refer to the operating instructions supplied with your disc.

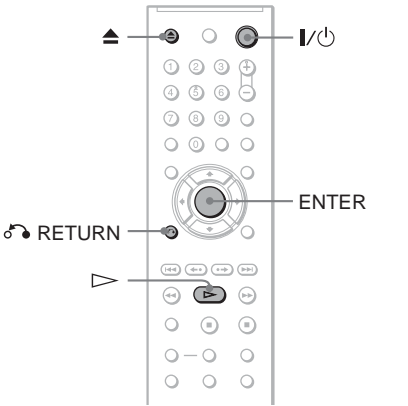

1 Turn on your TV.

2 Press .

The player turns on.

3 Switch the input selector on your TV so that the signal from the player appears on the TV screen.

◆ **When using an amplifier (receiver)**
Turn on the amplifier (receiver) and select the appropriate channel so that you can hear sound from the player.

4 Press on the player, and place a disc on the disc tray.

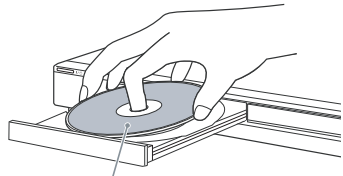

Playback side facing down

5 Press .

The disc tray closes. The player starts playback (continuous play). Adjust the volume on the TV or the amplifier (receiver).

Depending on the disc, a menu may appear on the TV screen. For DVD VIDEOS, see page 24. For VIDEO CDs, see page 25.

To turn off the player

Press . The player enters standby mode.

Hint

You can have the player turn off automatically whenever you leave it in stop mode for more than 30 minutes. To turn this function on or off, set "AUTO POWER OFF" in "CUSTOM SETUP" to "ON" or "OFF" (page 58).

Notes on playing DTS sound tracks on a DVD VIDEO

- DTS audio signals are output only through the DIGITAL OUT (COAXIAL) jack.
- When you play a DVD VIDEO with DTS sound tracks, set "DTS" to "ON" in "AUDIO SETUP" (page 60).
- If you connect the player to audio equipment without a DTS decoder, do not set "DTS" to "ON" in "AUDIO SETUP" (page 60). A loud noise may come out from the speakers, affecting your ears or causing the speakers to be damaged.

Note

Discs created on DVD recorders must be correctly finalized before they can be played. For more information about finalizing, refer to the operating instructions supplied with the DVD recorder.

Additional operations

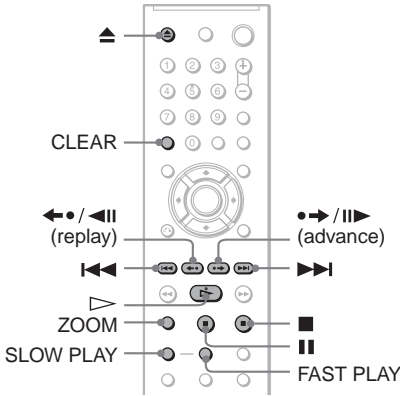

To	Operation
Stop	Press ■
Pause	Press
Resume play after pause	Press or ▷
Go to the next chapter, track, or scene in continuous play mode	Press ▶▶
Go back to the previous chapter, track, or scene in continuous play mode	Press ◀◀
Stop play and remove the disc	Press ▲
Replay the previous scene* ¹	Press ←•/◀◀ (replay) during playback
Briefly fast forward the current scene* ²	Press ▶▶/▶ (advance) during playback
Magnify the image* ³	Press ZOOM repeatedly. Press CLEAR to cancel.

*¹ DVD VIDEOS/DVD-RWs/DVD-Rs only.

*² DVD VIDEOS/DVD-RWs/DVD-Rs/DVD+RWs/DVD+Rs only.

*³ Video and JPEG pictures only (except BACKGROUND pictures). You can move the enlarged picture using ←/↑/↓/→. Depending upon the contents of the disc, the zoom function may be cancelled automatically when the picture is moved.

Note

You may not be able to use the Replay or Advance function with some scenes.

Playback quickly or slowly with sound

You can listen to dialogue or sound while playing the current scene quickly or slowly.

During playback, press FAST PLAY or SLOW PLAY.

The speed changes when you press either FAST PLAY or SLOW PLAY.

To return to normal playback

Press ▷.

Notes

- You can only use this function with DVDs/VIDEO CDs/Super VCDs and DVD-RWs in VR mode only.
- “Operation not possible” will appear when maximum or minimum speed is reached.
- During FAST PLAY and SLOW PLAY mode, you cannot change angle (page 40), subtitle (page 40), and the sound (page 37). The sound can only be changed for VIDEO CDs/Super VCDs.
- Fast Play and Slow Play functions do not work when playing DTS sound tracks.
- You cannot use Fast Play and Slow Play function when playing a still picture on DVD-RW in VR mode.

Locking the disc tray (Child Lock)

You can lock the disc tray to prevent children from opening it.

When the player is in standby mode, press ⏮ RETURN, ENTER, and then ||⏻ on the remote.

The player turns on and “LOCKED” appears on the front panel display. The ▲ and ▲ buttons on the player or the remote do not work while the Child Lock is set.

To unlock the disc tray

When the player is in standby mode, press ⏮ RETURN, ENTER, and then ||⏻ again.

Note

Even if you select “RESET” under “SETUP” in the Control Menu (page 56), the disc tray remains locked.

Resuming Playback from the Point Where You Stopped the Disc (Resume Play)

Play) DVD-V DVD-RW VCD CD DATA CD

The player remembers the point where you stopped the disc even if the player enters standby mode by pressing **I/O**.

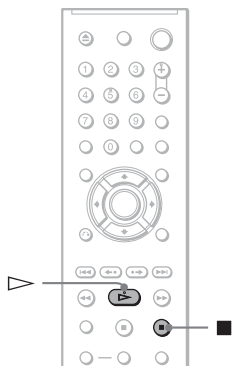

1 While playing a disc, press ■ to stop playback.

“RESUME” appears on the front panel display.

2 Press ▷.

The player starts playback from the point where you stopped the disc in Step 1.

Hint

To play from the beginning of the disc, press ■ twice, then press ▷.

Notes

- The resume playback point for the current disc is cleared when:
 - you change the play mode.
 - you change the settings on the Setup Display.
 - you disconnect the mains lead (CD or DATA CD/DATA DVD only).
- When playing a DVD-RW in VR mode, the point where you stopped is cleared when the disc tray is opened or the mains lead is disconnected.
- When playing a CD, the point where you stopped is cleared when the disc tray is opened or the mains lead is disconnected.

- When playing a DATA CD, the point where you stopped is cleared when the player enters standby mode, the disc tray is opened, or the mains lead is disconnected.
- This function may not work with some discs.
- Resume Play does not work during Shuffle Play and Programme Play.

Using the DVD's Menu

DVD-V

A DVD is divided into long sections of a picture or a music feature called "titles." When you play a DVD which contains several titles, you can select the title you want using the TOP MENU button. When you play DVDs that allow you to select items such as language for the sound and subtitles, select these items using the MENU button.

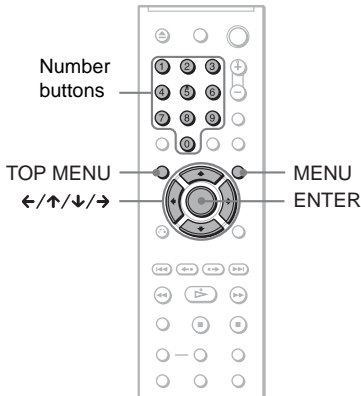

1 Press TOP MENU or MENU.

The disc's menu appears on the TV screen. The contents of the menu vary from disc to disc.

2 Press ←/↑/↓/→ or the number buttons to select the item you want to play or change.

If you press the number buttons, the following display appears. Press the number buttons to select the item you want.



3 Press ENTER.

Selecting "ORIGINAL" or "PLAY LIST" on a DVD-RW

DVD-RW

Some DVD-RWs in VR (Video Recording) mode have two types of titles for playback: originally recorded titles (ORIGINAL) and titles that can be created on recordable DVD players for editing (PLAY LIST). You can select the type of title to be played.

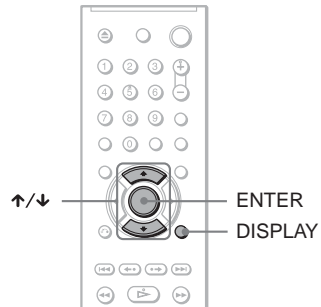

1 Press DISPLAY when the player is in stop mode.

The Control Menu appears.

2 Press ↑/↓ to select (ORIGINAL/PLAY LIST), then press ENTER.

The options for "ORIGINAL/PLAY LIST" appear.

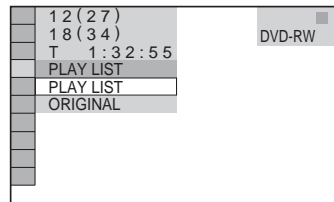

3 Press ↑/↓ to select a setting.

- PLAY LIST: plays the titles created from "ORIGINAL" for editing.
- ORIGINAL: plays the titles originally recorded.

4 Press ENTER.

Playing VIDEO CDs With PBC Functions (PBC Playback)

VCD

PBC (Playback Control) allows you to play VIDEO CDs interactively by following the menu on the TV screen.

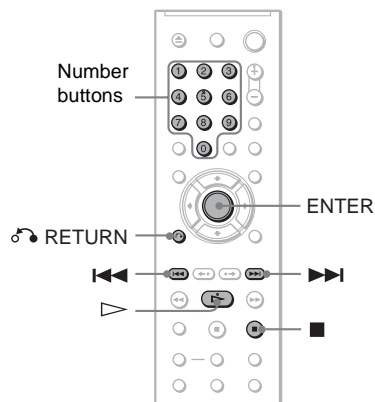

1 Start playing a VIDEO CD with PBC functions.

The menu for your selection appears.

2 Press the number buttons to select the item number you want.

3 Press ENTER.

4 Follow the instructions in the menu for interactive operations.

Refer to the instructions supplied with the disc, as the operating procedure may differ depending on the VIDEO CD.

Hint

To play without using PBC, press **⏮/⏭** or the number buttons while the player is stopped to select a track, then press **▷** or ENTER.

“Play without PBC” appears on the TV screen and the player starts continuous play. You cannot play still pictures such as a menu.

To return to PBC playback, press **■** twice then press **▷**.

Note

Depending on the VIDEO CD, “Press ENTER” in step 3 may appear as “Press SELECT” in the instructions supplied with the disc. In this case, press **▷**.

To return to the menu

Press **↶** RETURN.

Various Play Mode Functions (Programme Play, Shuffle Play, Repeat Play, A-B Repeat Play)

You can set the following play modes:

- Programme Play (page 26)
- Shuffle Play (page 27)
- Repeat Play (page 28)
- A-B Repeat Play (page 29)

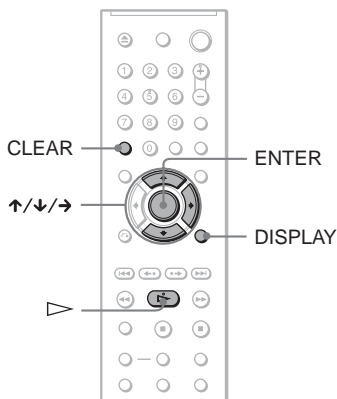

Note

The play mode is cancelled when:

- you eject the disc.
- the player enters standby mode by pressing **I/⏻**.

Creating your own programme (Programme Play) **DVD-V VCD CD**

You can play the contents of a disc in the order you want by arranging the order of the titles, chapters, or tracks on the disc to create your own programme. You can programme up to 99 titles, chapters, and tracks.

- 1 Press **DISPLAY**.
The Control Menu appears.
- 2 Press **↑/↓** to select **PROGRAM**, then press **ENTER**.
The options for "PROGRAM" appear.

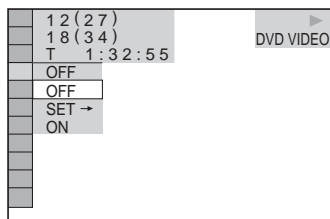

- 3 Press **↑/↓** to select "SET →," then press **ENTER**.

"TRACK" is displayed when you play a VIDEO CD or CD.

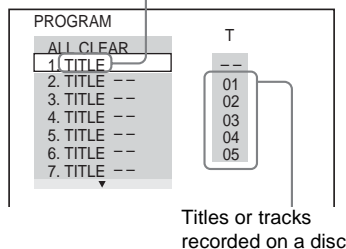

- 4 Press **→**.

The cursor moves to the title or track row "T" (in this case, "01").

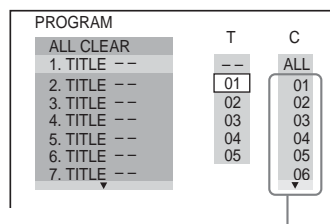

- 5 Select the title, chapter, or track you want to programme.

◆ When playing a DVD VIDEO

For example, select chapter "03" of title "02."

Press **↑/↓** to select "02" under "T," then press **ENTER**.

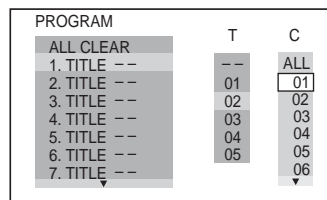

Next, press \uparrow/\downarrow to select "03" under "C," then press ENTER.

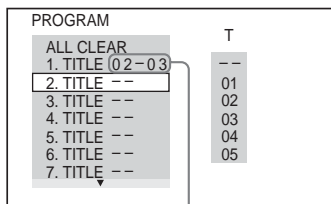

Selected title and chapter

◆ **When playing a VIDEO CD or CD**

For example, select track "02." Press \uparrow/\downarrow to select "02" under "T," then press ENTER.

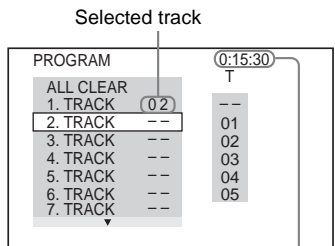

Total time of the programmed tracks

6 To programme other titles, chapters, or tracks, repeat steps 4 to 5.

The programmed titles, chapters, and tracks are displayed in the selected order.

7 Press \triangleright to start Programme Play.

Programme Play begins. When the programme ends, you can restart the same programme again by pressing \triangleright .

To return to normal play

Press CLEAR, or select "OFF" in step 3. To play the same programme again, select "ON" in step 3 and press ENTER.

To change or cancel a programme

- Follow steps 1 to 3 of "Creating your own programme (Programme Play)."
- Select the programme number of the title, chapter, or track you want to change or cancel using \uparrow/\downarrow and press \rightarrow . If you want to delete the title, chapter, or track from the programme, press CLEAR.

- Follow step 5 for new programming. To cancel a programme, select "--" under "T," then press ENTER.

To cancel all of the titles, chapters, or tracks in the programmed order

- Follow steps 1 to 3 of "Creating your own programme (Programme Play)."
- Press \uparrow and select "ALL CLEAR."
- Press ENTER.

Hint

You can perform Repeat Play or Shuffle Play of programmed titles, chapters, or tracks. During Programme Play, follow the steps of Repeat Play (page 28) or Shuffle Play (page 27).

Notes

- When you programme tracks on a Super VCD, the total playing time is not displayed.
- You cannot use this function with VIDEO CDs or Super VCDs with PBC playback.

Playing in random order (Shuffle Play) **DVD-V VCD CD**

You can have the player "shuffle" titles, chapters, or tracks. Subsequent "shuffling" may produce a different playing order.

- Press DISPLAY during playback. The Control Menu appears.
- Press \uparrow/\downarrow to select  (SHUFFLE), then press ENTER. The options for "SHUFFLE" appear.

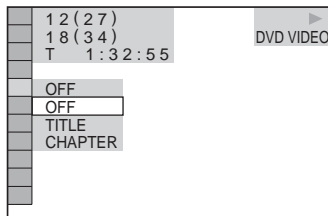

- Press \uparrow/\downarrow to select the item to be shuffled.

◆ **When playing a DVD VIDEO**

- TITLE
- CHAPTER

◆ **When playing a VIDEO CD or CD**

- TRACK

- ◆ **When Programme Play is activated**
- ON: shuffles titles, chapters, or tracks selected in Programme Play.

4 Press **ENTER**.
 Shuffle Play starts.

To return to normal play

Press **CLEAR**, or select “OFF” in step 3.

Hints

- You can set Shuffle Play while the player is stopped. After selecting the “SHUFFLE” option, press \triangleright . Shuffle Play starts.
- Up to 200 chapters in a disc can be played in random order when “CHAPTER” is selected.

Note

You cannot use this function with VIDEO CDs or Super VCDs with PBC playback.

Playing repeatedly (Repeat Play)

DVD-V **DVD-RW** **VCD** **CD** **DATA CD** **DATA DVD**

You can play all of the titles or tracks on a disc, or a single title, chapter, or track repeatedly.

You can use a combination of Shuffle or Programme Play modes.

1 Press **DISPLAY** during playback.
 The Control Menu appears.

2 Press \uparrow/\downarrow to select  (REPEAT), then press **ENTER**.
 The options for “REPEAT” appear.

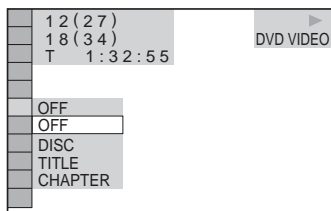

- ◆ **When playing a DVD VIDEO**
- DISC: repeats all of the titles.
- TITLE: repeats the current title on a disc.
- CHAPTER: repeats the current chapter.

- ◆ **When playing a DVD-RW**
- DISC: repeats all of the titles of the selected type.
- TITLE: repeats the current title on a disc.
- CHAPTER: repeats the current chapter.

- ◆ **When playing a VIDEO CD or CD**
- DISC: repeats all of the tracks.
- TRACK: repeats the current track.

- ◆ **When playing a DATA CD/DATA DVD with MP3 audio tracks or JPEG image files**

- DISC: repeats all of the albums.
- ALBUM: repeats the current album.
- TRACK (MP3 audio tracks only): repeats the current track.

- ◆ **When Programme Play or Shuffle Play is activated**

- ON: repeats Programme Play or Shuffle Play.

3 Press \uparrow/\downarrow to select a setting, and press **ENTER**.

To return to normal play

Press **CLEAR**, or select “OFF” in step 2.

Hint

You can set Repeat Play while the player is stopped. After selecting the “REPEAT” option, press \triangleright . Repeat Play starts.

Notes

- You cannot use this function with VIDEO CDs or Super VCDs with PBC playback.
- When repeating a DATA CD/DATA DVD which contains MP3 audio tracks and JPEG image files, and their playing times are not the same, the sound will not match the image.
- When “MODE (MP3, JPEG)” is set to “IMAGE (JPEG)” (page 48), you cannot select “TRACK.”

Repeating a specific portion (A-B Repeat Play)

DVD-V DVD-RW VCD CD

You can play a specific portion of a title, chapter or track repeatedly. (This function is useful when you want to memorize lyrics, etc.)

1 Press DISPLAY during playback.

The Control Menu appears.

2 Press \uparrow/\downarrow to select (A-B REPEAT), then press ENTER.

The options for “A-B REPEAT” appear.

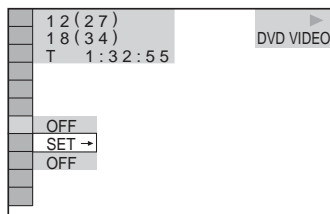

3 Press \uparrow/\downarrow to select “SET →,” then press ENTER.

The “A-B REPEAT” setting bar appears.

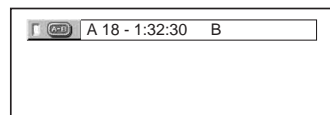

4 During playback, when you find the starting point (point A) of the portion to be played repeatedly, press ENTER.

The starting point (point A) is set.

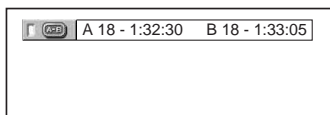

5 When you reach the ending point (point B), press ENTER again.

The set points are displayed and the player starts repeating this specific portion.

Notes

- When you set A-B Repeat Play, the settings for Shuffle Play, Repeat Play, and Programme Play are cancelled.
- A-B Repeat Play does not work across multiple titles.
- You may not set A-B Repeat Play for contents on a DVD-RW (VR mode) that contains still pictures.

To return to normal play

Press CLEAR, or select “OFF” in step 3.

Searching for a Scene

Searching for a Particular Point on a Disc (Search, Scan, Slow-motion Play, Freeze Frame)

You can quickly locate a particular point on a disc by monitoring the picture or playing back slowly.

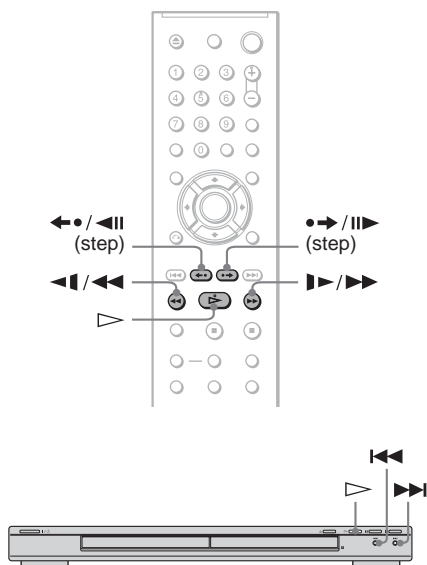

Notes

- Depending on the disc, you may not be able to do some of the operations described.
- For DATA CDs/DATA DVDs, you can search for a particular point only on MP3 audio track.

Locating a point quickly using the previous/next buttons (Search)

DVD-V DVD-RW VCD CD DATA CD DATA DVD

You can search for the next or previous chapter, track, or scene using **◀◀/▶▶** on the player.

During playback, press **▶▶** or **◀◀** once briefly to go to the next or previous chapter/track/scene. Or, press and hold **▶▶** or **◀◀** to search forward or backwards, and release the button when you find the point you want to return to normal playback. (Search)

Locating a point quickly by playing a disc in fast forward or fast reverse (Scan)

DVD-V DVD-RW VCD CD DATA CD DATA DVD

Press **◀◀◀◀** or **▶▶▶▶** while playing a disc. When you find the point you want, press **▷** to return to normal speed. Each time you press **◀◀◀◀** or **▶▶▶▶** during scan, the scan speed changes. With each press the indication changes as shown below. Actual speeds may differ between discs.

Playback direction



Opposite direction



The “×2▶”/“×2◀” playback speed is about twice the normal speed.

The “3▶▶▶”/“3◀◀◀” playback speed is faster than “2▶▶▶”/“2◀◀◀” and the “2▶▶▶”/“2◀◀◀” playback speed is faster than “1▶▶▶”/“1◀◀◀”.

Watching frame by frame (Slow-motion Play)

DVD-V DVD-RW VCD

Press ◀◀ or ▶▶ when the player is in pause mode. To return to normal speed, press ▷.

Each time you press ◀◀ or ▶▶ during Slow-motion Play, the playback speed changes. Two speeds are available. With each press the indication changes as follows:

Playback direction

2 ▶▶ ↔ 1 ▶▶

Opposite direction (DVD VIDEO/DVD-RW only)

2 ◀◀ ↔ 1 ◀◀

The “2 ▶▶”/“2 ◀◀” playback speed is slower than “1 ▶▶”/“1 ◀◀.”

Playing one frame at a time (Freeze Frame)

DVD-V DVD-RW VCD

When the player is in the pause mode, press ●→/III▶ (step) to go to the next frame. Press ◀●/◀III (step) to go to the preceding frame (DVD VIDEO/DVD-RW only). To return to normal playback, press ▷.

Note

You cannot search for a still picture on a DVD-RW in VR mode.

Searching for a Title/Chapter/Track/Scene, etc.

DVD-V DVD-RW VCD CD

DATA CD DATA DVD

You can search a DVD by title or chapter, and you can search a VIDEO CD/CD/DATA CD/DATA DVD by track, index, or scene. As titles and tracks are assigned unique numbers on the disc, you can select the desired one by entering its number. You can also search for a scene using the time code.

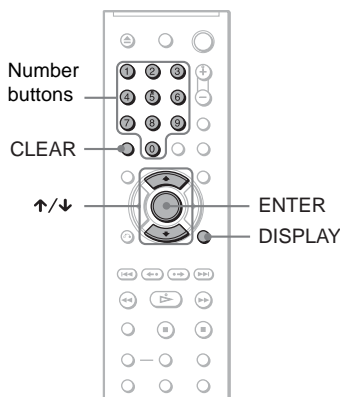

- 1 Press DISPLAY (When playing a DATA CD/DATA DVDs with JPEG image files, press twice).

The Control Menu appears.

- 2 Press ↑/↓ to select the search method.

- ◆ When playing a DVD VIDEO/DVD-RW



TITLE



CHAPTER



TIME/TEXT

Select “TIME/TEXT” to search for a starting point by inputting the time code.

- ◆ When playing a VIDEO CD or Super VCD without PBC playback



TRACK



INDEX

- ◆ When playing a VIDEO CD or Super VCD with PBC Playback



- ◆ When playing a CD



- ◆ When playing a DATA CD/DATA DVD

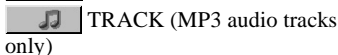

Example: when you select CHAPTER

“** (**)” is selected (** refers to a number).

The number in parentheses indicates the total number of titles, chapters, tracks, indexes, scenes, albums or files.

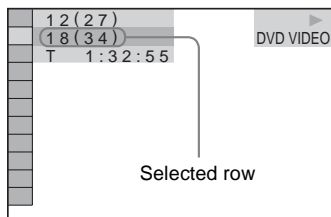

3 Press ENTER.

“** (**)” changes to “-- (**).”

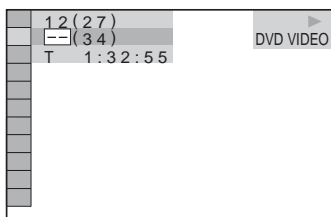

4 Press the number buttons to select the title, chapter, track, index, or scene, etc. number you want to search.

- ◆ If you make a mistake
Cancel the number by pressing CLEAR, then select another number.

5 Press ENTER.

The player starts playback from the selected number.

To search for a scene using the time code (DVD VIDEO/DVD-RW only)

- 1 In step 2, select TIME/TEXT. “T **:**:**” (playing time of the current title) is selected.
- 2 Press ENTER. “T **:**:**” changes to “T --:--:--.”
- 3 Input the time code using the number buttons, then press ENTER. For example, to find the scene at 2 hours, 10 minutes, and 20 seconds after the beginning, just enter “2:10:20.”

💡 Hints

- When the Control Menu display is turned off, you can search for a chapter (DVD VIDEO/DVD-RW) or track (CD/DATA CD/DATA DVD) by pressing the number buttons and ENTER.
- You can display the first scene of titles, chapters, or tracks recorded on the disc on a screen divided into 9 sections. You can start playback directly by selecting one of the scenes. For details, see “Searching by Scene (PICTURE NAVIGATION)” (page 33).

Notes

- The title, chapter, or track number displayed is the same number recorded on the disc.
- You cannot search for a scene on a DVD+RW/DVD+R using the time code.

Searching by Scene

(PICTURE NAVIGATION) **DVD-V VCD**

You can divide the screen into 9 subscreens and find the desired scene quickly.

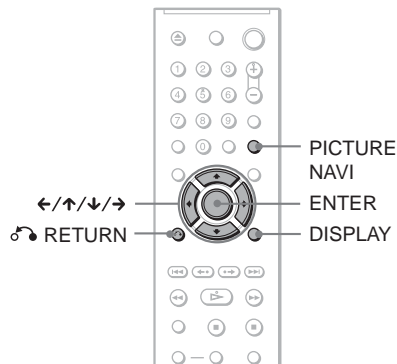

1 Press PICTURE NAVI during playback.

The following display appears.

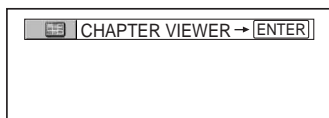

2 Press PICTURE NAVI repeatedly to select an item.

- CHAPTER VIEWER (DVD VIDEO only): displays the first scene of each chapter.
- TITLE VIEWER (DVD VIDEO only): displays the first scene of each title.
- TRACK VIEWER (VIDEO CD/ Super VCD only): displays the first scene of each track.

3 Press ENTER.

The first scene of each chapter, title, or track appears as follows.

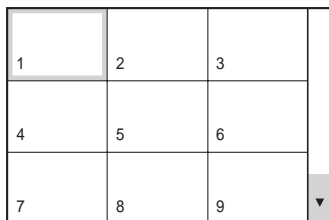

4 Press $\leftarrow/\uparrow/\downarrow/\rightarrow$ to select a chapter, title, or track, and press ENTER.

Playback starts from the selected scene.

To return to normal play during setting Press \curvearrowright RETURN or DISPLAY.

Hint

If there are more than 9 chapters, titles, or tracks, ▼ is displayed at the bottom right of the screen. To display the additional chapters, titles, or tracks, select the bottom scenes and press \downarrow . To return to the previous scene, select the top scenes and press \uparrow .

Note

Depending on the disc, you may not be able to select some items.

Viewing Information About the Disc

Checking the Playing Time and Remaining Time

Time **DVD-V** **DVD-RW** **VCD** **CD**

DATA CD **DATA DVD**

You can check the playing time and remaining time of the current title, chapter, or track. Also, you can check the DVD/CD text or track name (MP3 audio) recorded on the disc.

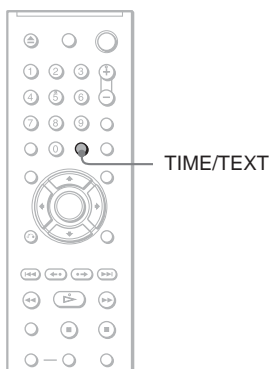

1 Press TIME/TEXT during playback.

The following display appears.

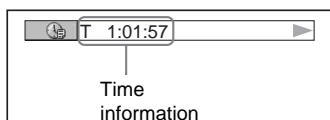

2 Press TIME/TEXT repeatedly to change the time information.

The available time information depends upon the type of disc you are playing.

◆ When playing a DVD VIDEO or DVD-RW

- T *:*: (hours: minutes: seconds)
Playing time of the current title
- T- *:*:
Remaining time of the current title
- C *:*:
Playing time of the current chapter
- C- *:*:
Remaining time of the current chapter

◆ When playing a VIDEO CD or Super VCD (with PBC functions)

- *:*: (minutes: seconds)
Playing time of the current scene

◆ When playing a VIDEO CD (without PBC functions) or CD

- T *:*: (minutes: seconds)
Playing time of the current track
- T- *:*:
Remaining time of the current track
- D *:*:
Playing time of the current disc
- D- *:*:
Remaining time of the current disc

◆ When playing a Super VCD (without PBC functions)

- T *:*: (minutes: seconds)
Playing time of the current track

◆ When playing a DATA CD or DATA DVD (MP3 audio)

- T *:*: (minutes: seconds)
Playing time of the current track

Checking the play information of the disc

To check the DVD/CD text

Press TIME/TEXT repeatedly in step 2 to display text recorded on the DVD/CD. The DVD/CD text appears only when text is recorded in the disc. You cannot change the text. If the disc does not contain text, "NO TEXT" appears.

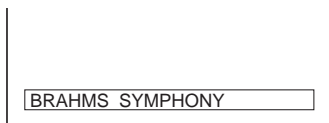

To check DATA CD/DATA DVD (MP3 audio) album name, etc.

By pressing TIME/TEXT while playing MP3 audio tracks on a DATA CD/DATA DVD, you can display the name of the album/track and the audio bit rate (the amount of data per second of the current audio track) on your TV screen.

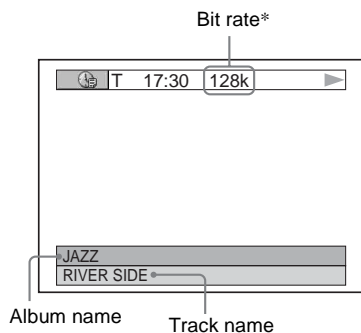

* Appears when:
– playing an MP3 audio track on a DATA CD/
DATA DVD.

Checking the information on the front panel display

You can view the time information and text displayed on the TV screen also on the front panel display. The information on the front panel display changes as follows when you change the time information on your TV screen.

When playing a DVD VIDEO or DVD-RW

Playing time of the current title

T 103:24



Remaining time of the current title

T - 1:15:36



Playing time of the current chapter

C 0:22:30



Remaining time of the current chapter

C - 0:13:20



Text

SONY HI



Current title and chapter number

T 16 8

(returns to top automatically)

When playing a DATA CD/DATA DVD (MP3 audio)

Playing time and number of the current track

6 2:25

Track name

01HAPPY

Current album and track number

1 6

(returns to top automatically)

When playing a VIDEO CD (without PBC functions), or CD

Playing time and number of the current track

3 2:25

Remaining time of the current track

3 - 1:50

Playing time of the disc

32:12

Remaining time of the disc

-20:18

Text

SONY HI

Current track and index number*

3 1

(returns to top automatically)

Hints

- When playing VIDEO CDs without PBC functions, the track number and the index number are displayed after the text.
- When playing VIDEO CDs with PBC functions, the scene number or the playing time are displayed.
- Long text that does not fit in a single line will scroll across the front panel display.
- You can also check the time information and text using the Control Menu (page 11).

Notes

- Depending on the type of disc being played, the DVD/CD discs text or track name may not be displayed.
- The player can only display the first level of the DVD/CD text, such as the disc name or title.
- Playing time of MP3 audio tracks files may not be displayed correctly.
- If you play a disc containing JPEG image files only, "NO AUDIO DATA" appears when "MODE (MP3, JPEG)" is set to "AUTO," "JPEG" appears when "MODE (MP3, JPEG)" is set to "IMAGE (JPEG)" in the front panel display.

* The current track and index number appear only when playing a VIDEO CD.

Sound Adjustments

Changing the Sound **DVD-V****DVD-RW** **VCD** **CD** **DATA CD****DATA DVD**

When playing a DVD VIDEO recorded in multiple audio formats (PCM, Dolby Digital, MPEG audio, or DTS), you can change the audio format. If the DVD VIDEO is recorded with multilingual tracks, you can also change the language.

With CDs, DATA CDs, DATA DVDs or VIDEO CDs, you can select the sound from either the right or left channel and listen to the sound of the selected channel through both the right and left speakers. For example, when playing a disc containing a song with the vocals on the right channel and the instruments on the left channel, you can hear the instruments from both speakers by selecting the left channel.

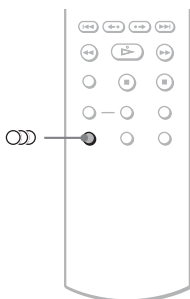

1 Press (audio) during playback.

The following display appears.

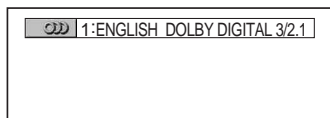

2 Press (audio) repeatedly to select the desired audio signal.

◆ When playing a DVD VIDEO

Depending on the DVD VIDEO, the choice of language varies.

When 4 digits are displayed, they indicate a language code. See “Language Code List” on page 67 to see which language the code represents. When the same language is displayed two or more times, the DVD VIDEO is recorded in multiple audio formats.

◆ When playing a DVD-RW

The types of sound tracks recorded on a disc are displayed. The default setting is underlined.

Example:

- 1: MAIN (main sound)
- 1: SUB (sub sound)
- 1: MAIN+SUB (main and sub sound)

◆ When playing a VIDEO CD, CD, DATA CD or DATA DVD (MP3 audio)

The default setting is underlined.

- STEREO: the standard stereo sound
- 1/L: the sound of the left channel (monaural)
- 2/R: the sound of the right channel (monaural)

◆ When playing a Super VCD

The default setting is underlined.

- 1:STEREO: the stereo sound of the audio track 1
- 1:1/L: the sound of the left channel of the audio track 1 (monaural)
- 1:2/R: the sound of the right channel of the audio track 1 (monaural)
- 2:STEREO: the stereo sound of the audio track 2
- 2:1/L: the sound of the left channel of the audio track 2 (monaural)
- 2:2/R: the sound of the right channel of the audio track 2 (monaural)

Note

While playing a Super VCD on which the audio track 2 is not recorded, no sound will come out when you select “2:STEREO,” “2:1/L,” or “2:2/R.”

Checking the audio signal format **DVD-V**

You can check the audio signal format by pressing  (audio) repeatedly during playback. The format of the current audio signal (Dolby Digital, DTS, PCM, etc.) appears as shown below.

◆When playing a DVD VIDEO

Example:

Dolby Digital 5.1 ch

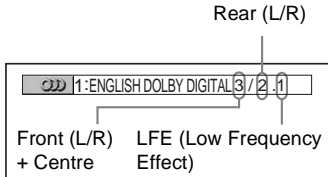

Example:

Dolby Digital 3 ch

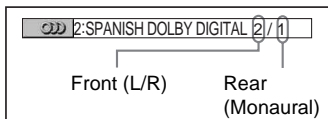

About audio signals

Audio signals recorded in a disc contain the sound elements (channels) shown below. Each channel is output from a separate speaker.

- Front (L)
- Front (R)
- Centre
- Rear (L)
- Rear (R)
- Rear (Monaural): This signal can be either the Dolby Surround Sound processed signals or the Dolby Digital sound's monaural rear audio signals.
- LFE (Low Frequency Effect) signal

Notes

- If "DTS" in "AUDIO SETUP" is set to "OFF," the DTS track selection option will not appear on the screen even if the disc contains DTS tracks (page 60).
- MPEG audio signals with more than two channels will appear as shown above (3/2.1, 2/1), but only the Front (L) and Front (R) signals will be output from your two front speakers.

TV Virtual Surround Settings (TVS) **DVD-V**

When you connect a stereo TV or 2 front speakers, TVS (TV Virtual Surround) lets you enjoy surround sound effects by using sound imaging to create virtual rear speakers from the sound of the front speakers (L: left, R: right) without using actual rear speakers. TVS was developed by Sony to produce surround sound for home use using just a stereo TV.

If the player is set up to output the signal from the DIGITAL OUT (COAXIAL) jack, the surround effect will only be heard when "DOLBY DIGITAL" is set to "D-PCM" and "MPEG" is set to "PCM" in "AUDIO SETUP" (page 60).

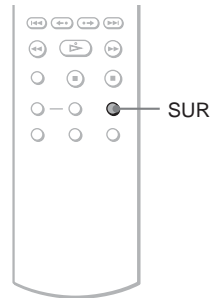

1 Press SUR during playback.

The following display appears.

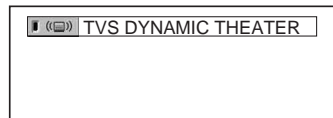

2 Press SUR repeatedly to select one of the TVS sounds.

See the explanations given for each item in the following section.

- TVS DYNAMIC THEATER
- TVS DYNAMIC
- TVS WIDE
- TVS NIGHT
- TVS STANDARD

To cancel the setting

Select "OFF" in step 2.

◆TVS DYNAMIC THEATER

Creates one set of LARGE virtual rear speakers and virtual subwoofer from the sound of the front speakers (L, R) without using actual rear speakers and subwoofer (shown below).

This mode is effective when the distance between the front L and R speakers is short, such as with built-in speakers on a stereo TV.

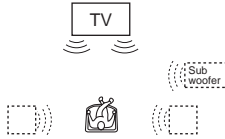

◆TVS DYNAMIC

Creates one set of virtual rear speakers from the sound of the front speakers (L, R) without using actual rear speakers (shown below).

This mode is effective when the distance between the front L and R speakers is short, such as with built-in speakers on a stereo TV.

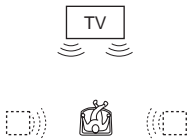

◆TVS WIDE

Creates five sets of virtual rear speakers from the sound of the front speakers (L, R) without using actual rear speakers (shown below).

This mode is effective when the distance between the front L and R speakers is short, such as with built-in speakers on a stereo TV.

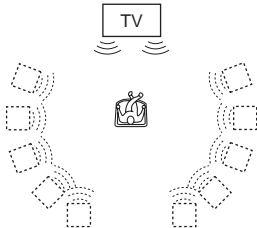

◆TVS NIGHT

Large sounds, such as explosions, are suppressed, but quieter sounds are unaffected. This feature is useful when you want to hear the dialogue and enjoy the surround sound effects of "TVS WIDE" at low volume.

◆TVS STANDARD

Creates three sets of virtual rear speakers from the sound of the front speakers (L, R) without using actual rear speakers (shown below). Use this setting when you want to use TVS with 2 separate speakers.

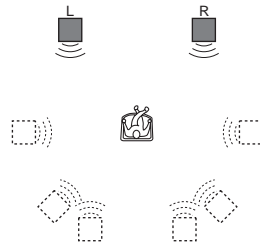

L: Front speaker (left)
R: Front speaker (right)
□: Virtual speaker

Notes

- When the playing signal does not contain a signal for the rear speakers, you cannot hear the surround effects.
- When you select one of the TVS modes, turn off the surround setting of the connected TV or amplifier (receiver).
- Make sure that your listening position is between and at an equal distance from your speakers, and that the speakers are located in similar surroundings.
- Not all discs will respond to the "TVS NIGHT" function in the same way.
- The TVS effects do not work when using the Fast Play or Slow Play functions, even though you can change the TVS modes.

Changing the Angles

DVD-V

If various angles (multi-angles) for a scene are recorded on the DVD VIDEO, “” appears in the front panel display. This means that you can change the viewing angle.

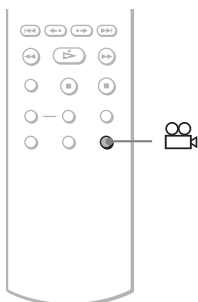

1 Press (angle) during playback.

The number of the angle appears on the display.

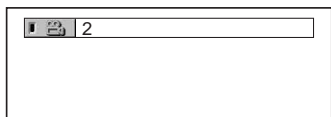

2 Press (angle) repeatedly to select an angle number.

The scene changes to the selected angle.

Note

Depending on the DVD VIDEO, you may not be able to change the angles even if multi-angles are recorded on the DVD VIDEO.

Displaying the Subtitles

DVD-V DVD-RW

If subtitles are recorded on the discs, you can change the subtitles or turn them on and off whenever you want while playing the disc.

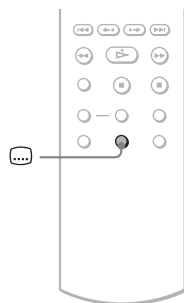

1 Press (subtitle) during playback.

The following display appears.

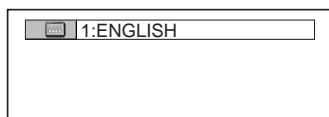

2 Press (subtitle) repeatedly to select a setting.

◆ **When playing a DVD VIDEO**
 Select the language.
 Depending on the DVD VIDEO, the choice of language varies.
 When 4 digits are displayed, they indicate a language code. See “Language Code List” on page 67 to see which language the code represents.

◆ **When playing a DVD-RW**
 Select “ON.”

To turn off the subtitles
Select "OFF" in step 2.

Notes

- Depending on the DVD VIDEO, you may not be able to change the subtitles even if multilingual subtitles are recorded on it. You also may not be able to turn them off.
- While playing a disc with subtitles, the subtitle may disappear when you press FAST PLAY or SLOW PLAY button.

Adjusting the Playback Picture (CUSTOM PICTURE MODE)

DVD-V DVD-RW VCD DATA CD

DATA DVD

You can adjust the video signal of the DVD, VIDEO CD or DATA CD/DATA DVD in JPEG format from the player to obtain the picture quality you want. Choose the setting that best suits the programme you are watching. When you select "MEMORY," you can make further adjustments to each element of the picture (colour, brightness, etc.).

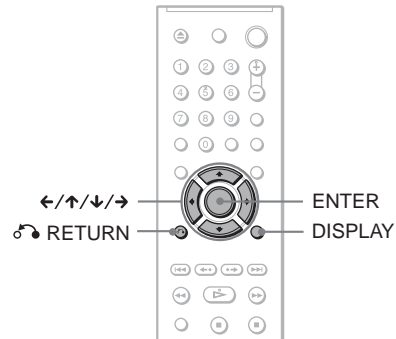

- 1** Press DISPLAY during playback.
(When playing a DATA CD/DATA DVD press twice)

The Control Menu appears.

- 2** Press ↑/↓ to select  (CUSTOM PICTURE MODE), then press ENTER.

The options for "CUSTOM PICTURE MODE" appear.

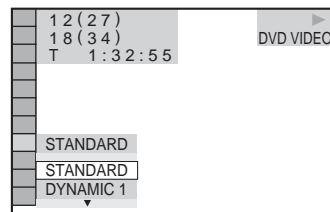

3 Press \uparrow/\downarrow to select the setting you want.

The default setting is underlined.

- STANDARD: displays a standard picture.
- DYNAMIC 1: produces a bold dynamic picture by increasing the picture contrast and the colour intensity.
- DYNAMIC 2: produces a more dynamic picture than DYNAMIC 1 by further increasing the picture contrast and colour intensity.
- CINEMA 1: enhances details in dark areas by increasing the black level.
- CINEMA 2: white colours become brighter and black colours become richer, and the colour contrast is increased.
- MEMORY: adjusts the picture in greater detail.

4 Press ENTER.

The selected setting takes effect.

Hint

When you watch a movie, "CINEMA 1" or "CINEMA 2" is recommended.

Adjusting the picture items in "MEMORY"

You can adjust each element of the picture individually.

- PICTURE: changes the contrast
- BRIGHTNESS: changes the overall brightness
- COLOR: makes the colours deeper or lighter
- HUE: changes the colour balance

1 In step 3 of "Adjusting the Playback Picture," select "MEMORY" and press ENTER.

The "PICTURE" adjustment bar appears.



2 Press \leftarrow/\rightarrow to adjust the picture contrast.

To go to the next or previous picture item without saving the current setting, press \uparrow/\downarrow .

3 Press ENTER.

The adjustment is saved, and "BRIGHTNESS" adjustment bar appears.

4 Repeat step 2 and 3 to adjust "BRIGHTNESS," "COLOR," and "HUE."

To turn off the display

Press  RETURN, or DISPLAY.

Sharpening the Pictures (SHARPNESS)

DVD-V DVD-RW VCD DATA CD

DATA DVD

You can enhance the outlines of images to produce a sharper picture.

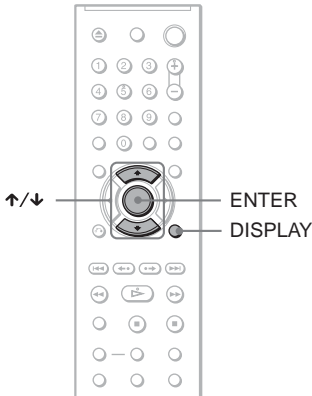

1 Press **DISPLAY** during playback (when playing a DATA CD/DATA DVD, press twice).

The Control Menu appears.

2 Press **↑/↓** to select  (**SHARPNESS**), then press **ENTER**.

The options for “SHARPNESS” appear.

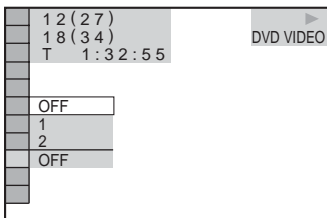

3 Press **↑/↓** to select a level.

- 1: enhances the outline.
- 2: enhances the outline more than 1.

4 Press **ENTER**.

The selected setting takes effect.

To cancel the “SHARPNESS” setting
Select “OFF” in step 3.

Enjoying MP3 Audio and JPEG Images

About MP3 Audio Tracks and JPEG Image Files

MP3 is audio compression technology that satisfies the ISO/IEC MPEG regulations. JPEG is image compression technology. You can play DATA CDs/DATA DVD that contain MP3 audio tracks or JPEG image files.

DATA CDs/DATA DVDs that the player can play

You can play back DATA CDs (CD-ROMs/CD-Rs/CD-RWs) or DATA DVDs (DVD-ROMs/DVD+RWs/DVD+Rs/DVD-RWs/DVD-Rs) recorded in MP3 (MPEG-1 Audio Layer III) and JPEG format. However, the discs must be recorded according to ISO9660 Level 1/ Level 2 or Joliet format and DATA DVDs of Universal Disk Format (UDF) for the player to recognize the tracks (or files). Refer to the instructions supplied with the CD-R/CD-RW drives and the recording software (not supplied) for details on the recording format.

Note

The player may not be able to play some DATA CDs/DATA DVDs created in the Packet Write format.

MP3 audio track or JPEG image file that the player can play

The player can play the following tracks and files:

- MP3 audio tracks with the extension “.MP3.”
- JPEG image files with the extension “.JPEG” or “.JPG.”
- JPEG image files that conform to the DCF* image file format.

* “Design rule for Camera File system”: Image standards for digital cameras regulated by JEITA (Japan Electronics and Information Technology Industries Association).

Notes

- The player will play any data with the extension “.MP3,” “.JPG,” or “.JPEG,” even if they are not in MP3 or JPEG format. Playing these data may generate a loud noise which could damage your speaker system.
- The player does not conform to audio tracks in mp3PRO format.
- Some JPEG files cannot be played.

About playback order of albums, tracks, and files

Albums play in the following order:

◆Structure of disc contents

Tree 1 Tree 2 Tree 3 Tree 4 Tree 5

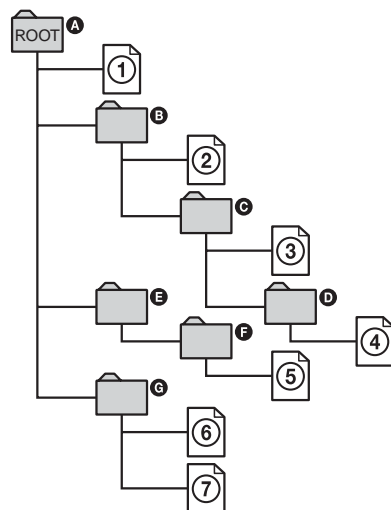

When you insert a DATA CD/DATA DVD and press \triangleright , the numbered tracks (or files) are played sequentially, from ① through ⑦. Any sub-albums/tracks (or files) contained within a currently selected album take priority over the next album in the same tree. (Example: ③ contains ④ so ④ is played before ⑤.)

When you press MENU and the list of album names appears (page 46), the album names are arranged in the following order: ① → ② → ③ → ④ → ⑤ → ⑥ → ⑦. Albums that do not contain tracks (or files) (such as album ⑤) do not appear in the list.

Hints

- If you add numbers (01, 02, 03, etc.) to the front of the track/file names when you store the tracks (or files) in a disc, the tracks and files will be played in that order.
- Since a disc with many trees takes longer to start playback, it is recommended that you create albums with no more than two trees.

Notes

- Depending on the software you use to create the DATA CD/DATA DVD, the playback order may differ from the above illustration.
- The playback order above may not be applicable if there are more than 200 albums and 300 tracks/files in each album.
- The player can recognize up to 200 albums (the player will count just albums, including albums that do not contain MP3 audio tracks and JPEG image files). The player will not play any albums beyond the 200th album.
- Proceeding to the next or another album may take some time.

Playing MP3 Audio Tracks or JPEG Image Files **DATA CD** **DATA DVD**

You can play MP3 audio tracks and JPEG image files on DATA CDs (CD-ROMs/CD-Rs/CD-RWs) or DATA DVDs (DVD-ROMs/DVD+RWs/DVD+Rs/DVD-RWs/DVD-Rs).

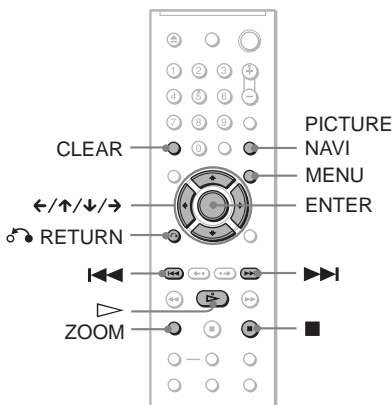

Hint

You can view the disc information while playing MP3 audio tracks (page 34).

Notes

- DATA CDs recorded in KODAK Picture CD format automatically start playing when inserted.
- If no MP3 audio track or JPEG image file is recorded on the DATA CD/DATA DVD, “No audio data” or “No image data” appears on the screen.

Selecting an album

- 1 Press **MENU**.
The list of albums on the disc appears.
When an album is being played, its title is shaded.



- 2 Press **↑/↓** to select the album you want to play.
- 3 Press **▷**.
Playback starts from the selected album.
To select MP3 audio tracks, see “Selecting an MP3 audio track” (page 46).
To select JPEG image files, see “Selecting a JPEG image file” (page 47).

To stop playback

Press **■**.

To go to the next or previous page

Press **→** or **←**.

To turn on or off the display

Press **MENU** repeatedly.

Hint

Of the selected album, you can select to play only the MP3 audio tracks, JPEG image files, or both, by setting “MODE (MP3, JPEG)” (page 48).

Selecting an MP3 audio track

- 1 After step 2 of “Selecting an album,” press **ENTER**.
The list of tracks in the album appears.

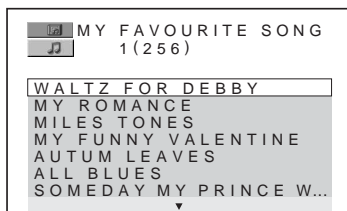

- 2 Press **↑/↓** to select a track, and press **ENTER**.
Playback starts from the selected track.

To stop playback

Press **■**.

To go to the next or previous page

Press **→** or **←**.

To return to the previous display

Press **↶** RETURN.

To go to the next or previous MP3 audio track

Press **▶▶** or **◀◀** during playback. You can select the first track of the next album by pressing **▶▶** during playback of the last track of the current album.

Note that you cannot return to the previous album by using **◀◀**, and that you need to select the previous album from the album list.

Selecting a JPEG image file

1 After step 2 of "Selecting an album," press PICTURE NAVI.

The image files in the album appear in 16 subscreens. A scroll box is displayed on the right.

1	2	3	4
5	6	7	8
9	10	11	12
13	14	15	16

To display the additional image, select the bottom images and press \downarrow . To return to the previous image, select the top images and press \uparrow .

2 Press $\leftarrow/\uparrow/\downarrow/\rightarrow$ to select the image you want to view, and press ENTER.

The selected image appears.
Example

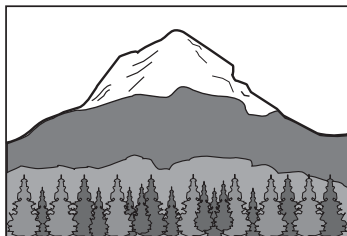

To go to the next or previous JPEG image file

Press \leftarrow or \rightarrow during playback. You can select the first file of the next album by pressing \rightarrow during playback of the last file of the current album.

Note that you cannot return to the previous album by using \leftarrow , and that you need to select the previous album from the album list.

To rotate a JPEG image

Press \uparrow/\downarrow while viewing the image. Each time you press \uparrow , the image rotates counterclockwise by 90 degrees.

To return to normal view, press CLEAR.

Note that the view also returns to normal if you press \leftarrow/\rightarrow to go to the next or previous image.

Example: when \uparrow is pressed once.

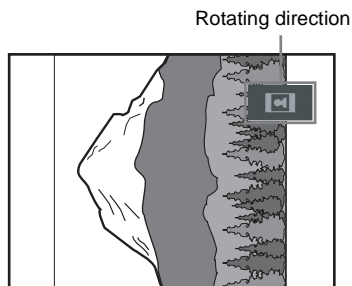

To magnify a JPEG image (ZOOM)

Press ZOOM while viewing the image. You can enlarge the image up to four times the original size, and scroll using $\leftarrow/\uparrow/\downarrow/\rightarrow$.

To return to normal view, press CLEAR.

◆When pressed once (x2)

The image enlarges twice the original size.

◆When pressed twice (x4)

The image enlarges four times the original size.

To stop viewing the JPEG image

Press ■.

💡 Hints

- While viewing JPEG image files, you can set options such as "INTERVAL" (page 49), "EFFECT" (page 50), and "SHARPNESS" (page 43).
- You can view JPEG images files without MP3 audio by setting "MODE (MP3, JPEG)" to "IMAGE (JPEG)" (page 48).
- The date the picture was taken is displayed beside "DATE" in the Control Menu (page 11). Note that no date may appear depending on the digital camera.

Note

PICTURE NAVI does not work if "AUDIO (MP3)" is selected in "MODE (MP3, JPEG)" (page 48).

Enjoying JPEG Images as a Slide Show

DATA CD DATA DVD

You can play JPEG image files on a DATA CD or DATA DVD successively as a slide show.

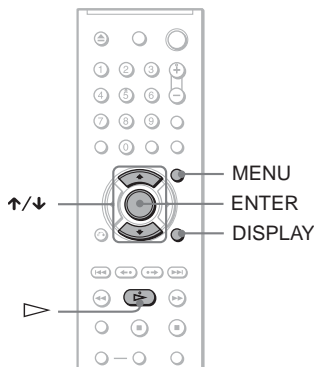

1 Press MENU.

The list of albums on the DATA CD/DATA DVD appears.



2 Press \uparrow/\downarrow to select an album.

3 Press \triangleright .

The JPEG images in the selected album start playing as a slide show.

To stop playback

Press \blacksquare .

Notes

- The slide show stops when \uparrow/\downarrow or ZOOM is pressed. To resume the slide show, press \triangleright .
- This function does not work if "MODE (MP3, JPEG)" is set to "AUDIO (MP3)" (page 48).

Viewing a slide show with sound (MODE (MP3, JPEG))

When JPEG image files and MP3 audio tracks are placed in the same album, you can enjoy a slide show with sound.

1 Press DISPLAY during stop mode.

The Control Menu appears.

2 Press \uparrow/\downarrow to select MODE (MODE (MP3, JPEG)), and press ENTER.

The options for "MODE (MP3, JPEG)" appear.

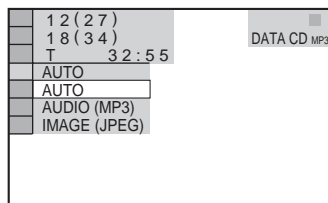

3 Press \uparrow/\downarrow to select "AUTO" (default), and press ENTER.

- AUTO: plays both the JPEG image files and MP3 audio tracks in the same album as a slide show.
- AUDIO (MP3): plays only MP3 audio tracks continuously.
- IMAGE (JPEG): plays only JPEG image files continuously.

4 Press MENU.

The list of albums on the DATA CD/DATA DVD appears.



5 Press \uparrow/\downarrow to select the album that contains both the MP3 audio tracks and JPEG images you want to play.

6 Press \triangleright .

A slide show starts with sound.

Hints

- To repeat both MP3 audio tracks and JPEG image files in a single album, repeat the same MP3 audio track or album when “MODE (MP3, JPEG)” is set to “AUTO.” See “Playing repeatedly (Repeat Play)” (page 28) to repeat the track or album.
- The player recognizes a maximum of 200 albums regardless of the selected mode. Of each album, the player recognizes up to 300 MP3 audio tracks and 300 JPEG image files when “AUTO” is selected, 600 MP3 audio tracks when “AUDIO (MP3)” is selected, 600 JPEG image files when “IMAGE (JPEG)” is selected.

Notes

- This function does not work if the MP3 audio tracks and JPEG image files are not placed in the same album.
- If playing time of JPEG image or MP3 audio is longer than the other, the longer one continues without sound or image.
- If you play large MP3 track data and JPEG image data at the same time, the sound may skip. It is recommended that you set the MP3 bit rate to 128 kbps or lower when creating the file. If the sound still skips, then reduce the size of the JPEG file.

Setting the pace for a slide show (INTERVAL)

You can set the time the slides are displayed on the screen.

- 1 Press **DISPLAY** twice while viewing a JPEG image or when the player is in stop mode.

The Control Menu appears.

- 2 Press **↑/↓** to select  (INTERVAL), then press **ENTER**.

The options for “INTERVAL” appear.

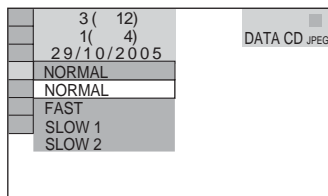

- 3 Press **↑/↓** to select a setting.

The default setting is underlined.

- **NORMAL**: sets the duration to between 6 to 9 seconds.
- **FAST**: sets a duration shorter than NORMAL.
- **SLOW 1**: sets a duration longer than NORMAL.
- **SLOW 2**: sets a duration longer than SLOW 1.

- 4 Press **ENTER**.

Note

Some JPEG files, especially progressive JPEG files or JPEG files of 3,000,000 pixels or more, may take longer to display than others, which may make the duration seem longer than the setting you selected.

Selecting the slides' appearance (EFFECT)

You can select the way the slides are displayed during a slide show.

1 Press **DISPLAY** twice while viewing a JPEG image or when the player is in stop mode.

2 Press **↑/↓** to select  (EFFECT), then press **ENTER**.

The options for “EFFECT” appear.

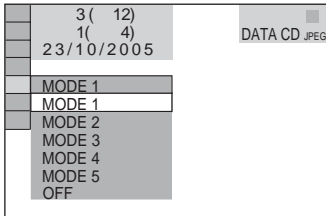

3 Press **↑/↓** to select a setting.

The default setting is underlined.

- MODE 1: the image sweeps in from top to bottom.
- MODE 2: the image sweeps in from left to right.
- MODE 3: the image stretches out from the centre of the screen.
- MODE 4: the images randomly cycle through the effects.
- MODE 5: the next image slides over the previous image.
- OFF: turns off this function.

4 Press **ENTER**.

Using Various Additional Functions

Locking Discs (CUSTOM PARENTAL CONTROL, PARENTAL CONTROL)

You can set two kinds of playback restrictions for a disc.

- Custom Parental Control
You can set playback restrictions so that the player will not play inappropriate discs.
- Parental Control
Playback of some DVD VIDEOS can be limited according to a predetermined level such as the age of the users. Scenes may be blocked or replaced with different scenes. The same password is used for both Parental Control and Custom Parental Control.

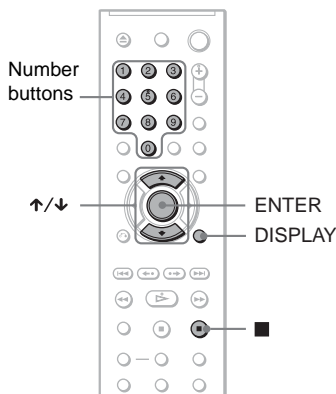

Custom Parental Control DVD-V

VCD CD

You can set the same Custom Parental Control password for up to 40 discs. When you set the 41st-disc, the first disc is cancelled.

- 1 Insert the disc you want to lock.
If the disc is playing, press ■ to stop playback.
- 2 Press DISPLAY while the player is in stop mode.
The Control Menu appears.

- 3 Press ↑/↓ to select  (PARENTAL CONTROL), then press ENTER.

The options for “PARENTAL CONTROL” appear.

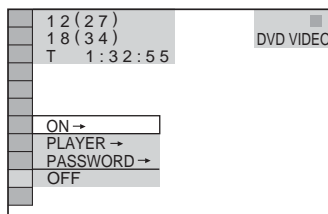

- 4 Press ↑/↓ to select “ON →,” then press ENTER.

◆ If you have not entered a password
The display for registering a new password appears.

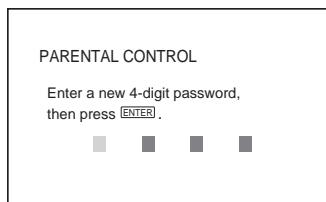

Enter a 4-digit password using the number buttons, then press ENTER. The display for confirming the password appears.

◆ When you have already registered a password
The display for entering the password appears.

- 5 Enter or re-enter your 4-digit password using the number buttons, then press ENTER.

“Custom parental control is set.” appears and then the screen returns to the Control Menu.

To turn off the Custom Parental Control function

- 1 Follow steps 1 to 3 of “Custom Parental Control.”
- 2 Press ↑/↓ to select “OFF →,” then press ENTER.
- 3 Enter your 4-digit password using the number buttons, then press ENTER.

To play a disc for which Custom Parental Control is set

- 1 Insert the disc for which Custom Parental Control is set.
The "CUSTOM PARENTAL CONTROL" display appears.

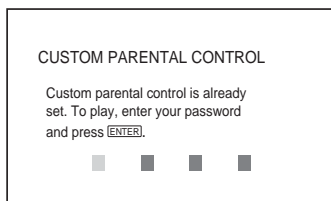

- 2 Enter your 4-digit password using the number buttons, then press ENTER.
The player is ready for playback.

Hint

If you forget your password, enter the 6-digit number "199703" using the number buttons when the "CUSTOM PARENTAL CONTROL" display asks you for your password, then press ENTER. The display will ask you to enter a new 4-digit password.

Parental Control (limited playback) **DVD-V**

Playback of some DVD VIDEOS can be limited according to a predetermined level such as the age of the users. The "PARENTAL CONTROL" function allows you to set a playback limitation level.

- 1 Press DISPLAY while the player is in stop mode.
The Control Menu appears.
- 2 Press \uparrow/\downarrow to select  (PARENTAL CONTROL), then press ENTER.

The options for "PARENTAL CONTROL" appear.

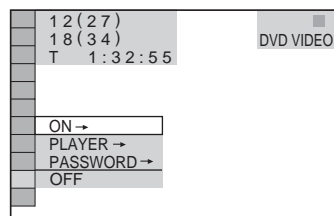

- 3 Press \uparrow/\downarrow to select "PLAYER →," then press ENTER.

◆ If you have not entered a password
The display for registering a new password appears.

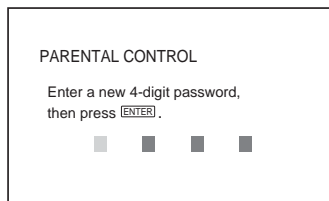

Enter a 4-digit password using the number buttons, then press ENTER.
The display for confirming the password appears.

◆ When you have already registered a password
The display for entering the password appears.

- 4 Enter or re-enter your 4-digit password using the number buttons, then press ENTER.

The display for setting the playback limitation level appears.

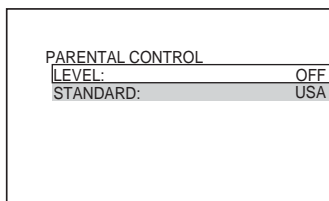

- 5 Press \uparrow/\downarrow to select "STANDARD," then press ENTER.
The selection items for "STANDARD" are displayed.

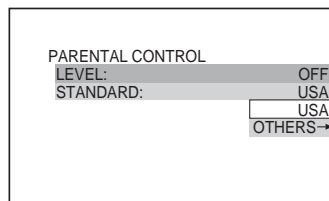

- 6 Press \uparrow/\downarrow to select a geographic area as the playback limitation level, then press ENTER.

The area is selected.

When you select "OTHERS →," select and enter a standard code in the table on page 67 using the number buttons.

7 Press \uparrow/\downarrow to select "LEVEL," then press ENTER.

The selection items for "LEVEL" are displayed.

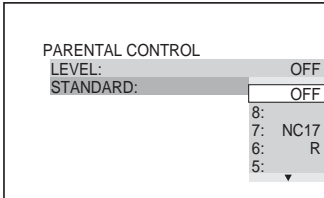

8 Select the level you want using \uparrow/\downarrow , then press ENTER.

Parental Control setting is complete.

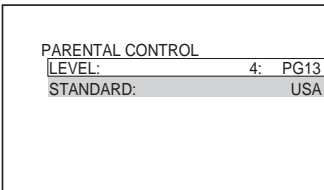

The lower the value, the stricter the limitation.

To turn off the Parental Control function

Set "LEVEL" to "OFF" in step 8.

To play a disc for which Parental Control is set

- 1 Insert the disc and press \triangleright .
The display for entering your password appears.
- 2 Enter your 4-digit password using the number buttons, then press ENTER.
The player starts playback.

Hint

If you forget your password, remove the disc and repeat steps 1 to 3 of "Parental Control (limited playback)." When you are asked to enter your password, enter "199703" using the number buttons, then press ENTER. The display will ask you to enter a new 4-digit password. After you enter a new 4-digit password, replace the disc in the player and press \triangleright . When the display for entering your password appears, enter your new password.

Notes

- When you play discs which do not have the Parental Control function, playback cannot be limited on this player.
- Depending on the disc, you may be asked to change the parental control level while playing the disc. In this case, enter your password, then change the level. If the Resume Play mode is cancelled, the level returns to the previous level.

Changing the password

- 1 Press DISPLAY while the player is in stop mode.
The Control Menu appears.
- 2 Press \uparrow/\downarrow to select (PARENTAL CONTROL), then press ENTER.
The options for "PARENTAL CONTROL" appear.
- 3 Press \uparrow/\downarrow to select "PASSWORD →," then press ENTER.
The display for entering the password appears.
- 4 Enter your 4-digit password using the number buttons, then press ENTER.
- 5 Enter a new 4-digit password using the number buttons, then press ENTER.
- 6 To confirm your password, re-enter it using the number buttons, then press ENTER.

If you make a mistake entering your password

Press \leftarrow before you press ENTER and input the correct number.

Controlling Your TV With the Supplied Remote

You can control the sound level, input source, and power switch of your Sony TV with the supplied remote.

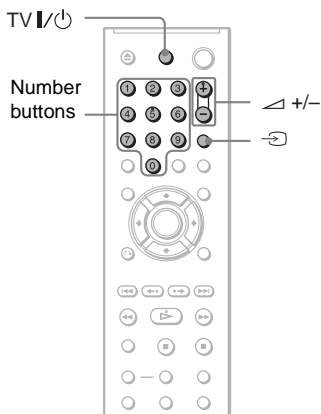

You can control your TV using the buttons below.

By pressing	You can
TV I/O	Turn the TV on or off
△ (volume) +/-	Adjust the volume of the TV
Ⓜ (TV/video)	Switch the TV's input source between the TV and other input sources

Note

Depending on the connected unit, you may not be able to control your TV using all or some of the buttons on the supplied remote.

Using the Setup Display

By using the Setup Display, you can make various adjustments to items such as picture and sound. You can also set a language for the subtitles and the Setup Display, among other things.

For details on each Setup Display item, see pages from 56 to 60.

Note

Playback settings stored in the disc take priority over the Setup Display settings and not all of the functions described may work.

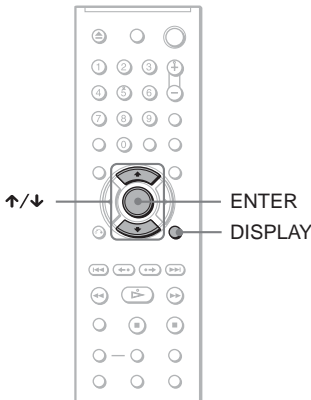

- 1 Press **DISPLAY** when the player is in stop mode.

The Control Menu appears.

- 2 Press **↑/↓** to select  (**SETUP**), then press **ENTER**.

The options for “SETUP” appear.

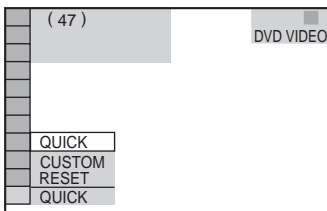

- 3 Press **↑/↓** to select “CUSTOM,” then press **ENTER**.

The Setup Display appears.

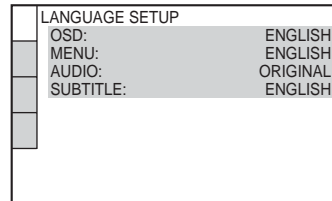

- 4 Press **↑/↓** to select the setup item from the displayed list: “LANGUAGE SETUP,” “SCREEN SETUP,” “CUSTOM SETUP,” or “AUDIO SETUP.” Then press **ENTER**.

The Setup item is selected.

Example: “SCREEN SETUP”

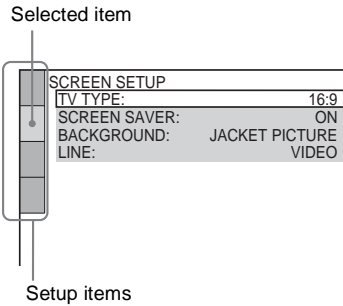

- 5 Press **↑/↓** to select an item, then press **ENTER**.

The options for the selected item appear.

Example: “TV TYPE”

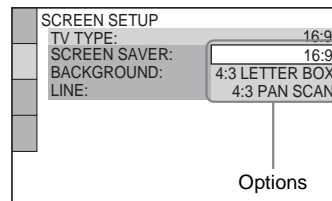

6 Press \uparrow/\downarrow to select a setting, then press ENTER.

The setting is selected and setup is complete.

Example: "4:3 PAN SCAN"

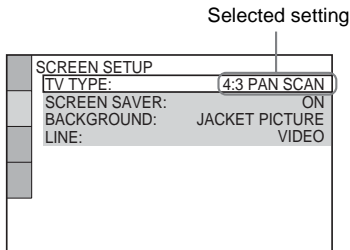

To enter the Quick Setup mode

Select "QUICK" in step 3. Follow from step 5 of the Quick Setup explanation to make basic adjustments (page 19).

To reset all of the "SETUP" settings

- 1 Select "RESET" in step 3 and press ENTER.
- 2 Select "YES" using \uparrow/\downarrow .
You can also quit the process and return to the Control Menu by selecting "NO" here.
- 3 Press ENTER.
All the settings explained on pages 56 to 59 return to the default settings. Do not press I/Power while resetting the player, which takes a few seconds to complete.

Setting the Display or Sound Track Language (LANGUAGE SETUP)

"LANGUAGE SETUP" allows you to set various languages for the on-screen display or sound track.

Select "LANGUAGE SETUP" in the Setup Display. To use the display, see "Using the Setup Display" (page 55).

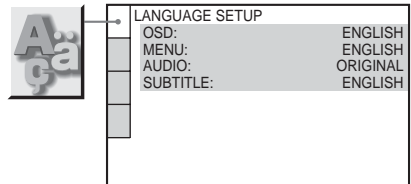

◆ OSD (On-Screen Display)

Switches the display language on the screen.

◆ MENU (DVD VIDEO only)

You can select the desired language for the disc's menu.

◆ AUDIO (DVD VIDEO only)

Switches the language of the sound track. When you select "ORIGINAL," the language given priority in the disc is selected.

◆ SUBTITLE (DVD VIDEO only)

Switches the language of the subtitle recorded on the DVD VIDEO.

When you select "AUDIO FOLLOW," the language for the subtitles changes according to the language you selected for the sound track.

💡 Hint

If you select "OTHERS \rightarrow " in "MENU," "SUBTITLE," or "AUDIO," select and enter a language code from "Language Code List" on page 67 using the number buttons.

Note

If you select a language in "MENU," "SUBTITLE," or "AUDIO" that is not recorded on a DVD VIDEO, one of the recorded languages will be automatically selected.

Settings for the Display

(SCREEN SETUP)

Choose settings according to the TV to be connected.

Select "SCREEN SETUP" in the Setup Display. To use the display, see "Using the Setup Display" (page 55).

The default settings are underlined.

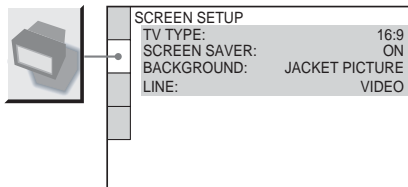

◆ TV TYPE

Selects the aspect ratio of the connected TV (4:3 standard or wide).

<u>16:9</u>	Select this when you connect a wide-screen TV or a TV with a wide mode function.
4:3 LETTER BOX	Select this when you connect a 4:3 screen TV. Displays a wide picture with bands on the upper and lower portions of the screen.
4:3 PAN SCAN	Select this when you connect a 4:3 screen TV. Automatically displays the wide picture on the entire screen and cuts off the portions that do not fit.

16:9



4:3 LETTER BOX



4:3 PAN SCAN

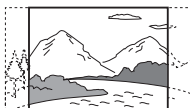

Note

Depending on the DVD, "4:3 LETTER BOX" may be selected automatically instead of "4:3 PAN SCAN" or vice versa.

◆ SCREEN SAVER

The screen saver image appears when you leave the player in pause or stop mode for 15 minutes, or when you play a CD or DATA CD/DATA DVD (MP3 audio) for more than 15 minutes. The screen saver will help prevent your display device from becoming damaged (ghosting). Press \triangleright to turn off the screen saver.

<u>ON</u>	Turns on the screen saver.
OFF	Turns off the screen saver.

◆ BACKGROUND

Selects the background colour or picture on the TV screen when the player is in stop mode or while playing a CD or DATA CD/DATA DVD (MP3 audio).

<u>JACKET PICTURE</u>	The jacket picture (still picture) appears, but only when the jacket picture is already recorded on the disc (CD-EXTRA, etc.). If the disc does not contain a jacket picture, the "GRAPHICS" picture appears.
GRAPHICS	A preset picture stored in the player appears.
BLUE	The background colour is blue.
BLACK	The background colour is black.

◆ LINE

Selects video signals output from the LINE (RGB)-TV jack on the rear panel of the player.

<u>VIDEO</u>	Outputs video signals.
S VIDEO	Outputs S video signals.
RGB	Outputs RGB signals.

Notes

- If your TV does not accept S video or the RGB signals, no picture will appear on the TV screen, even if you select "S VIDEO" or "RGB." Refer to the instructions supplied with your TV.
- If your TV has only one SCART (EURO AV) jack, do not select "S VIDEO."

Custom Settings (CUSTOM SETUP)

Use this to set up playback related and other settings.

Select "CUSTOM SETUP" in the Setup Display. To use the display, see "Using the Setup Display" (page 55).

The default settings are underlined.

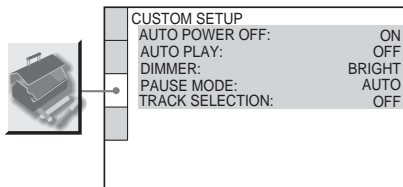

◆ AUTO POWER OFF

Switches the Auto Power Off setting on or off.

<u>ON</u>	The player enters standby mode when left in stop mode for more than 30 minutes.
OFF	Switches this function off.

◆ AUTO PLAY

Switches the Auto Play setting on or off. This function is useful when the player is connected to a timer (not supplied).

<u>OFF</u>	Switches this function off.
ON	Automatically starts playback when the player is turned on by a timer (not supplied).

◆ DIMMER

Adjusts the lighting of the front panel display.

<u>BRIGHT</u>	Makes the lighting bright.
DARK	Makes the lighting dark.

◆ PAUSE MODE (DVD VIDEO/DVD-RW only)

Selects the picture in pause mode.

<u>AUTO</u>	The picture, including subjects that move dynamically, is output with no jitter. Normally select this position.
FRAME	The picture, including subjects that do not move dynamically, is output in high resolution.

◆ TRACK SELECTION (DVD VIDEO only)

Gives the sound track which contains the highest number of channels priority when you play a DVD VIDEO on which multiple audio formats (PCM, MPEG audio, DTS, or Dolby Digital format) are recorded.

<u>OFF</u>	No priority given.
AUTO	Priority given.

Notes

- When you set the item to "AUTO," the language may change. The "TRACK SELECTION" setting has higher priority than the "AUDIO" settings in "LANGUAGE SETUP" (page 56).
- If you set "DTS" to "OFF" (page 60), the DTS sound track is not played even if you set "TRACK SELECTION" to "AUTO."
- If PCM, DTS, MPEG audio, and Dolby Digital sound tracks have the same number of channels, the player selects PCM, DTS, MPEG, and Dolby Digital audio sound tracks in this order.

Settings for the Sound

(AUDIO SETUP)

“AUDIO SETUP” allows you to set the sound according to the playback and connection conditions.

Select “AUDIO SETUP” in the Setup Display. To use the display, see “Using the Setup Display” (page 55).
The default settings are underlined.

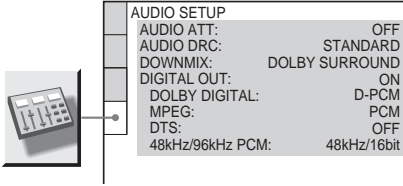

◆ AUDIO ATT (attenuation)

If the playback sound is distorted, set this item to “ON.” The player reduces the audio output level.

This function affects the output of the following jacks:

- LINE OUT L/R (AUDIO) jacks
- LINE (RGB)-TV jack

<u>OFF</u>	Normally, select this position.
ON	Select this when the playback sound from the speakers is distorted.

◆ AUDIO DRC (Dynamic Range Control) (DVD VIDEO/DVD-RW only)

Makes the sound clear when the volume is turned down when playing a DVD that conforms to “AUDIO DRC.”

This function affects the output from the following jacks:

- LINE OUT L/R (AUDIO) jacks
- LINE (RGB)-TV jack
- DIGITAL OUT (COAXIAL) jack only when “DOLBY DIGITAL” is set to “D-PCM” (page 60).

<u>STANDARD</u>	Normally select this position.
TV MODE	Makes low sounds clear even if you turn the volume down.
WIDE RANGE	Gives you the feeling of being at a live performance.

◆ DOWNMIX (DVD VIDEO/DVD-RW only)

Switches the method for mixing down to 2 channels when you play a DVD which has rear sound elements (channels) or is recorded in Dolby Digital format. For details on the rear signal components, see “Checking the audio signal format” (page 38). This function affects the output of the following jacks:

- LINE OUT L/R (AUDIO) jacks
- LINE (RGB)-TV jack
- DIGITAL OUT (COAXIAL) jack when “DOLBY DIGITAL” is set to “D-PCM” (page 60).

<u>DOLBY SURROUND</u>	Normally, select this position. Multi-channel audio signals are output to 2 channels for enjoying surround sounds.
NORMAL	Multi-channel audio signals are downmixed to 2 channels for use with your stereo.

◆ DIGITAL OUT

Selects if audio signals are output via the DIGITAL OUT (COAXIAL) jack.

<u>ON</u>	Normally select this position. When you select “ON,” see “Setting the digital output signal” for further settings.
OFF	The influence of the digital circuit upon the analog circuit is minimal.

Setting the digital output signal

Switches the method of outputting audio signals when you connect a component such as an amplifier (receiver) or MD deck with a digital input jack.

For connection details, see page 17.

Select “DOLBY DIGITAL,” “MPEG,” “DTS,” and “48kHz/96kHz PCM” after setting “DIGITAL OUT” to “ON.”

If you connect a component that is incompatible with the selected audio signal, a loud noise (or no sound) may be heard from the speakers, risking damage to your ears or speakers.

◆ DOLBY DIGITAL (DVD VIDEO/DVD-RW only)

Selects the type of Dolby Digital signal.

<u>D-PCM</u>	Select this when the player is connected to an audio component without a built-in Dolby Digital decoder. You can select whether the signals conform to Dolby Surround (Pro Logic) or not by making adjustments to the “DOWNMIX” item in “AUDIO SETUP” (page 59).
DOLBY DIGITAL	Select this when the player is connected to an audio component with a built-in Dolby Digital decoder.

◆ MPEG (DVD VIDEO/DVD-RW only)

Selects the type of MPEG audio signal.

<u>PCM</u>	Select this when the player is connected to an audio component without a built-in MPEG decoder. If you play MPEG audio sound tracks, the player outputs stereo signals via the DIGITAL OUT (COAXIAL) jack.
MPEG	Select this when the player is connected to an audio component with a built-in MPEG decoder.

◆ DTS

Selects whether or not to output DTS signals.

<u>OFF</u>	Select this when the player is connected to an audio component without a built-in DTS decoder.
ON	Select this when the player is connected to an audio component with a built-in DTS decoder.

◆ 48kHz/96kHz PCM (DVD VIDEO only)

Selects the sampling frequency of the audio signal.

<u>48kHz/16bit</u>	The audio signals of DVD VIDEOS are always converted to 48kHz/16bit.
96kHz/24bit	All types of signals including 96kHz/24bit are output in their original format. However, if the signal is encrypted for copyright protection purposes, the signal is only output as 48kHz/16bit.

Note

The analogue audio signals from the LINE OUT L/R (AUDIO) jacks are not affected by this setting and keep their original sampling frequency level.

Troubleshooting

If you experience any of the following difficulties while using the player, use this troubleshooting guide to help remedy the problem before requesting repairs. Should any problem persist, consult your nearest Sony dealer.

Power

The power is not turned on.

- ➔ Check that the mains lead is connected securely.

Picture

There is no picture/picture noise appears.

- ➔ Re-connect the connecting cord securely.
- ➔ The connecting cords are damaged.
- ➔ Check the connection to your TV (page 15) and switch the input selector on your TV so that the signal from the player appears on the TV screen.
- ➔ Set "LINE" in "SCREEN SETUP" to an item appropriate for your system (page 57).
- ➔ The disc is dirty or flawed.
- ➔ If the picture output from your player goes through your VCR to get to your TV or if you are connected to a combination TV/VIDEO player, the copy-protection signal applied to some DVD programmes could affect picture quality. If you still experience problems even when you connect your player directly to your TV, try connecting your player to your TV's S VIDEO input (page 15).
- ➔ The disc is recorded in a colour system that is different from your TV.

The picture does not fill the screen, even though the aspect ratio is set in "TV TYPE" under "SCREEN SETUP."

- ➔ The aspect ratio of the disc is fixed on your DVD.

The picture is black and white.

- ➔ Set "LINE" in "SCREEN SETUP" to an item appropriate for your TV (page 57).
- ➔ Depending on the TV, the picture on the screen becomes black and white when you play a disc recorded in the NTSC colour system.
- ➔ If you are using a SCART cord, be sure to use one that is fully wired (21-pins).

Sound

There is no sound.

- ➔ Re-connect the connecting cord securely.
- ➔ The connecting cord is damaged.
- ➔ The player is connected to the wrong input jack on the amplifier (receiver) (page 17).
- ➔ The amplifier (receiver) input is not correctly set.
- ➔ The player is in pause mode or in Slow-motion Play mode.
- ➔ The player is in fast forward or fast reverse mode.
- ➔ If the audio signal does not come through the DIGITAL OUT (COAXIAL) jack, check the audio settings (page 59).
- ➔ While playing a Super VCD on which the audio track 2 is not recorded, no sound will come out when you select "2:STEREO," "2:1/L," or "2:2/R."
- ➔ When playing multichannel MPEG audio soundtracks, only the Front (L) and Front (R) signal will be output from your two front speakers.

Sound distortion occurs.

- ➔ Set "AUDIO ATT" in "AUDIO SETUP" to "ON" (page 59).

The sound volume is low.

- ➔ The sound volume is low on some DVDs. The sound volume may improve if you set "AUDIO DRC" in "AUDIO SETUP" to "TV MODE" (page 59).
- ➔ Set "AUDIO ATT" in "AUDIO SETUP" to "OFF" (page 59).

Operation

The remote does not function.

- ➔ The batteries in the remote are weak.
- ➔ There are obstacles between the remote and the player.
- ➔ The distance between the remote and the player is too far.
- ➔ The remote is not pointed at the remote sensor on the player.

The disc does not play.

- ➔ The disc is turned over.
Insert the disc with the playback side facing down.
- ➔ The disc is skewed.
- ➔ The player cannot play certain discs (page 6).
- ➔ The region code on the DVD does not match the player.
- ➔ Moisture has condensed inside the player (page 3).
- ➔ The player cannot play a recorded disc that is not correctly finalized (page 6).

The MP3 audio track cannot be played (page 45).

- ➔ The DATA CD is not recorded in an MP3 format that conforms to ISO 9660 Level 1/Level 2 or Joliet.
- ➔ The DATA DVD is not recorded in MP3 format that conform to UDF (Universal Disk Format).
- ➔ The MP3 audio track does not have the extension “.MP3.”
- ➔ The data is not formatted in MP3 even though it has the extension “.MP3.”
- ➔ The data is not MPEG-1 Audio Layer III data.
- ➔ The player cannot play audio tracks in mp3PRO format.
- ➔ “MODE (MP3, JPEG)” is set to “IMAGE (JPEG)” (page 48).

The JPEG image file cannot be played (page 45).

- ➔ The DATA CD is not recorded in a JPEG format that conforms to ISO 9660 Level 1/Level 2, or Joliet.
- ➔ The DATA DVD is not recorded in JPEG format that conforms to UDF (Universal Disk Format).
- ➔ The file has an extension other than “.JPEG” or “.JPG.”

- ➔ The image is larger than 3072 (width) × 2048 (height) in normal mode, or more than 3,300,000 pixels in progressive JPEG. (Some progressive JPEG files cannot be displayed even if the file size is within this specified capacity.)
- ➔ The image does not fit the screen (the image is reduced).
- ➔ “MODE (MP3, JPEG)” is set to “AUDIO (MP3)” (page 48).

The MP3 audio tracks and JPEG image files start playing simultaneously.

- ➔ “MODE (MP3, JPEG)” is set to “AUTO” (page 48).

The album/track/file names are not displayed correctly.

- ➔ The player can only display numbers and alphabet. Other characters are displayed as “*”.

The disc does not start playing from the beginning.

- ➔ Programme Play, Shuffle Play, Repeat Play, or A-B Repeat Play is selected (page 26).
- ➔ Resume play has taken effect (page 23).

The player starts playing the disc automatically.

- ➔ The disc features an auto playback function.
- ➔ “AUTO PLAY” in “CUSTOM SETUP” is set to “ON” (page 58).

Playback stops automatically.

- ➔ While playing discs with an auto pause signal, the player stops playback at the auto pause signal.

Some functions such as Stop, Search, Fast Play and Slow Play, Slow-motion Play, Repeat Play, Shuffle Play, or Programme Play cannot be performed.

- ➔ Depending on the disc, you may not be able to do some of the operations above. Refer to the operating manual that comes with the disc.

The language for the sound track cannot be changed.

- ➔ Try using the DVD's menu instead of the direct selection button on the remote (page 24).
- ➔ Multilingual tracks are not recorded on the DVD being played.
- ➔ The DVD prohibits the changing of the language for the sound track.

The subtitle language cannot be changed or turned off.

- ➔ Try using the DVD's menu instead of the direct selection button on the remote (page 24).
- ➔ Multilingual subtitles are not recorded on the DVD being played.
- ➔ The DVD prohibits the changing of subtitles.

The angles cannot be changed.

- ➔ Try using the DVD's menu instead of the direct selection button on the remote (page 24).
- ➔ Multi-angles are not recorded on the DVD being played.
- ➔ The angle can only be changed when the "⏏" indicator lights up on the front panel display (page 9).
- ➔ The DVD prohibits changing of the angles.

The player does not operate properly.

- ➔ When static electricity, etc., causes the player to operate abnormally, unplug the player.

5 numbers or letters are displayed on the screen and on the front panel display.

- ➔ The self-diagnosis function was activated. (See the table on page 64.)

The disc tray does not open and "LOCKED" appears on the front panel display.

- ➔ Child Lock is set (page 22).

The disc tray does not open and "TRAY LOCKED" appears on the front panel display.

- ➔ Contact your Sony dealer or local authorized Sony service facility.

"Data error" appears on the TV screen when playing a DATA CD or DATA DVD.

- ➔ The MP3 audio track/JPEG image file you want to play is broken.
 - ➔ The data is not MPEG-1 Audio Layer III data.
 - ➔ The JPEG image file format does not conform to DCF (page 44).
 - ➔ The JPEG image file has the extension ".JPG" or ".JPEG," but is not in JPEG format.
-

Self-diagnosis Function

(When letters/numbers appear in the display)

When the self-diagnosis function is activated to prevent the player from malfunctioning, a five-character service number (e.g., C 13 50) with a combination of a letter and four digits appears on the screen and the front panel display. In this case, check the following table.

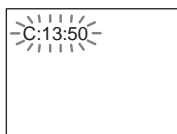

First three characters of the service number	Cause and/or corrective action
C 13	The disc is dirty or recorded in a format that this player cannot play (page 6). ➔ Clean the disc with a soft cloth or check its format (page 2).
C 31	The disc is not inserted correctly. ➔ Re-insert the disc correctly.
E XX (xx is a number)	To prevent a malfunction, the player has performed the self-diagnosis function. ➔ Contact your nearest Sony dealer or local authorized Sony service facility and give the 5-character service number. Example: E 61 10

Glossary

Album (page 44, 46)

A unit in which to store JPEG image files or MP3 audio tracks on a DATA CD/DATA DVD. ("Album" is an exclusive definition for this player.)

Chapter (page 9)

Sections of a picture or a music feature that are smaller than titles. A title is composed of several chapters. Depending on the disc, no chapters may be recorded.

Dolby Digital (page 18, 60)

Digital audio compression technology developed by Dolby Laboratories. This technology conforms to multi-channel surround sound. The rear channel is stereo and there is a discrete subwoofer channel in this format. Dolby Digital provides the same discrete channels of high quality digital audio found in "Dolby Digital" theatre surround sound systems. Good channel separation is realized because all of the channel data is recorded discretely and little deterioration is realized because all channel data processing is digital.

DTS (page 18, 60)

Digital audio compression technology that Digital Theater Systems, Inc. developed. This technology conforms to multi-channel surround sound. The rear channel is stereo and there is a discrete subwoofer channel in this format. DTS provides the same discrete channels of high quality digital audio. Good channel separation is realized because all of the channel data is recorded discretely and little deterioration is realized because all channel data processing is digital.

DVD VIDEO (page 5)

A disc that contains up to 8 hours of moving pictures even though its diameter is the same as a CD.

The data capacity of a single-layer and single-sided DVD is 4.7 GB (Giga Byte), which is 7 times that of a CD. The data capacity of a double-layer and single-sided DVD is 8.5 GB, a single-layer and double-sided DVD is 9.4 GB, and double-layer and double-sided DVD is 17 GB.

The picture data uses the MPEG 2 format, a worldwide standard of digital compression technology. The picture data is compressed to about 1/40 (average) of its original size. The DVD also uses a variable rate coding technology that changes the data to be allocated according to the status of the picture. Audio information is recorded in a multi-channel format, such as Dolby Digital, allowing you to enjoy a more realistic audio presence.

Furthermore, various advanced functions such as the multi-angle, multilingual, and Parental Control functions are provided with the DVD.

DVD-RW (page 5)

A DVD-RW is a recordable and rewritable disc that is the same size as a DVD VIDEO. The DVD-RW has two different modes: VR mode and Video mode. DVD-RWs created in Video mode have the same format as a DVD VIDEO, while discs created in VR (Video Recording) mode allow the contents to be programmed or edited.

DVD+RW (page 5)

A DVD+RW (plus RW) is a recordable and rewritable disc. DVD+RWs use a recording format that is comparable to the DVD VIDEO format.

File (page 44, 47)

A JPEG image recorded on a DATA CD/ DATA DVD ("File" is an exclusive definition for this player). A single file consist of a single image or video.

MPEG audio (page 18, 60)

International standard coding system used to compress audio digital signals authorized by ISO/IEC. MPEG 1 conforms to up to 2-channel stereo. MPEG 2, used on DVDs, conforms to up to 7.1-channel surround.

Title (page 9)

The longest section of a picture or music feature on a DVD, movie, etc., in video software, or the entire album in audio software.

Specifications

System

Laser: Semiconductor laser

Signal format system: PAL/(NTSC)

Audio characteristics

Frequency response: DVD VIDEO (PCM 96 kHz): 2 Hz to 44 kHz (± 1.0 dB)/DVD VIDEO (PCM 48 kHz): 2 Hz to 22 kHz (± 0.5 dB)/CD: 2 Hz to 20 kHz (± 0.5 dB)

Signal-to-noise ratio (S/N ratio): 115 dB (LINE OUT L/R (AUDIO) jacks only)

Harmonic distortion: 0.003 %

Dynamic range: DVD VIDEO: 103 dB/CD: 99 dB

Wow and flutter: Less than detected value ($\pm 0.001\%$ W PEAK)

Outputs

(Jack name): Jack type/Output level/Load impedance)

LINE OUT (AUDIO): Phono jack/2 Vrms/10 kilohms

DIGITAL OUT (COAXIAL): Phono jack/0.5 Vp-p/75 ohms

LINE OUT (VIDEO): Phono jack/1.0 Vp-p/75 ohms

General

Power requirements:

220 – 240 V AC, 50/60 Hz

Power consumption: 10 W

Dimensions (approx.): 430 × 43 × 237.2 mm (width/height/depth) incl. projecting parts

Mass (approx.): 1.92 kg

Operating temperature: 5 °C to 35 °C

Operating humidity: 25 % to 80 %

Supplied accessories

See page 14.

Specifications and design are subject to change without notice.

Language Code List

For details, see pages 37, 40, 56.

The language spellings conform to the ISO 639: 1988 (E/F) standard.

Code Language	Code Language	Code Language	Code Language
1027 Afar	1183 Irish	1347 Maori	1507 Samoan
1028 Abkhazian	1186 Scots Gaelic	1349 Macedonian	1508 Shona
1032 Afrikaans	1194 Galician	1350 Malayalam	1509 Somali
1039 Amharic	1196 Guarani	1352 Mongolian	1511 Albanian
1044 Arabic	1203 Gujarati	1353 Moldavian	1512 Serbian
1045 Assamese	1209 Hausa	1356 Marathi	1513 Siswati
1051 Aymara	1217 Hindi	1357 Malay	1514 Sesotho
1052 Azerbaijani	1226 Croatian	1358 Maltese	1515 Sundanese
1053 Bashkir	1229 Hungarian	1363 Burmese	1516 Swedish
1057 Byelorussian	1233 Armenian	1365 Nauru	1517 Swahili
1059 Bulgarian	1235 Interlingua	1369 Nepali	1521 Tamil
1060 Bihari	1239 Interlingue	1376 Dutch	1525 Telugu
1061 Bislama	1245 Inupiak	1379 Norwegian	1527 Tajik
1066 Bengali;	1248 Indonesian	1393 Occitan	1528 Thai
Bangla	1253 Icelandic	1403 (Afan)Oromo	1529 Tigrinya
1067 Tibetan	1254 Italian	1408 Oriya	1531 Turkmen
1070 Breton	1257 Hebrew	1417 Punjabi	1532 Tagalog
1079 Catalan	1261 Japanese	1428 Polish	1534 Setswana
1093 Corsican	1269 Yiddish	1435 Pashto;	1535 Tonga
1097 Czech	1283 Javanese	Pushto	1538 Turkish
1103 Welsh	1287 Georgian	1436 Portuguese	1539 Tsonga
1105 Danish	1297 Kazakh	1463 Quechua	1540 Tatar
1109 German	1298 Greenlandic	1481 Rhaeto-	1543 Twi
1130 Bhutani	1299 Cambodian	Romance	1557 Ukrainian
1142 Greek	1300 Kannada	1482 Kirundi	1564 Urdu
1144 English	1301 Korean	1483 Romanian	1572 Uzbek
1145 Esperanto	1305 Kashmiri	1489 Russian	1581 Vietnamese
1149 Spanish	1307 Kurdish	1491 Kinyarwanda	1587 Volapük
1150 Estonian	1311 Kirghiz	1495 Sanskrit	1613 Wolof
1151 Basque	1313 Latin	1498 Sindhi	1632 Xhosa
1157 Persian	1326 Lingala	1501 Sangho	1665 Yoruba
1165 Finnish	1327 Laothian	1502 Serbo-	1684 Chinese
1166 Fiji	1332 Lithuanian	Croatian	1697 Zulu
1171 Faroese	1334 Latvian;	1503 Singhalese	
1174 French	Lettish	1505 Slovak	
1181 Frisian	1345 Malagasy	1506 Slovenian	1703 Not specified

Additional Information

Parental Control Area Code List

For details, see page 52.

Code Area	Code Area	Code Area	Code Area
2044 Argentina	2165 Finland	2362 Mexico	2149 Spain
2047 Australia	2174 France	2376 Netherlands	2499 Sweden
2046 Austria	2109 Germany	2390 New Zealand	2086 Switzerland
2057 Belgium	2248 India	2379 Norway	2528 Thailand
2070 Brazil	2238 Indonesia	2427 Pakistan	2184 United Kingdom
2079 Canada	2254 Italy	2424 Philippines	
2090 Chile	2276 Japan	2436 Portugal	
2092 China	2304 Korea	2489 Russia	
2115 Denmark	2363 Malaysia	2501 Singapore	

Index

Numerics

- 16:9 57
- 4:3 LETTER BOX 57
- 4:3 PAN SCAN 57
- 48kHz/96kHz PCM 60
- 5.1 Channel Surround 38

A

- A-B REPEAT 29
- ADVANCE 22
- ALBUM 32
- Album 44, 64
- ANGLE 40
- AUDIO 37, 56
- AUDIO ATT 59
- AUDIO DRC 59
- AUDIO SETUP 59
- AUTO PLAY 58
- AUTO POWER OFF 58

B

- BACKGROUND 57
- Batteries 14

C

- CD 6, 21
- CHAPTER 31
- Chapter 64
- CHAPTER VIEWER 33
- Child Lock 22
- Connecting 15
- Continuous play
 - CD/VIDEO CD 21
 - DVD 21
- Control Menu 11
- CUSTOM 55
- CUSTOM PARENTAL CONTROL 51
- CUSTOM PICTURE MODE 41
- CUSTOM SETUP 58

D

- DATA CD 5, 44
- DATA DVD 5
- DATE 47
- DIGITAL OUT 59
- Digital output 60
- DIMMER 58
- Display
 - Control Menu Display 11
 - Front panel display 9
 - Setup Display 55
- DOLBY DIGITAL 37, 60, 64
- DOWNMIX 59
- DTS 37, 60, 64

- DVD 5, 21, 65
- DVD+RW 22, 65
- DVD's menu 24
- DVD-RW 5, 24, 65

E

- EFFECT 50

F

- Fast forward 30
- FAST PLAY 22
- Fast reverse 30
- FILE 32
- File 65
- Freeze Frame 31
- Front panel display 9

H

- Handling discs 2
- Hooking up 14

I

- INDEX 31
- INTERVAL 49

J

- JPEG 44

L

- LANGUAGE SETUP 56
- LINE 57
- Locating
 - a specific point by watching the TV screen 30

M

- MEMORY 42
- MENU 56
- MODE (MP3, JPEG) 48
- MP3 5, 44
- MPEG 37, 60, 65

O

- On-screen display
 - Control Menu Display 11
 - Setup Display 55
- ORIGINAL 24
- ORIGINAL/PLAY LIST 24
- OSD 56

P

- PARENTAL CONTROL 51
- PAUSE MODE 58
- PBC Playback 25
- PICTURE NAVIGATION 33, 47
- PLAY LIST 24
- PROGRAMME 26
- Programme Play 26

Q

- QUICK 56
- Quick Setup 19, 56

R

- Remote 10, 14, 54
- REPEAT 28
- Repeat Play 28
- REPLAY 22
- RESET 56
- Resume Play 23

S

- Scan 30
- SCENE 31
- SCREEN SAVER 57
- SCREEN SETUP 57
- Searching 30
- SETUP 55
- Setup Display 55
- SHARPNESS 43
- SHUFFLE 27
- Shuffle Play 27
- Slide Show 48
- SLOW PLAY 22
- Slow-motion Play 31
- Speakers
 - Hooking up 17
- SUBTITLE 56
- SURROUND 38

T

- TIME/TEXT 31, 34
- TITLE 31
- Title 65
- TITLE VIEWER 33
- TOP MENU 24
- TRACK 31
- TRACK SELECTION 58
- TRACK VIEWER 33
- Troubleshooting 61
- TV TYPE 57
- TVS (TV Virtual Surround) 38

U

- Usable discs 6

V

- VIDEO CD 5, 21

Z

- ZOOM 22, 47



Printed on 100% recycled paper.



2-651-444-11(1)