

Trinitron Color TV

Operating Instructions _____ **GB**

- Before operating the unit, please read this manual thoroughly and retain it for future reference.

使用説明書 _____ **CT**

- 使用本電視機之前請先詳細閱讀此手冊，並妥善保存以備日後用作參考。

Panduan Pengendalian _____ **MY**

- Sebelum mengendalikan unit, sila baca buku panduan ini dengan teliti dan simpan untuk rujukan masa depan.

KV-XA29
KV-XA25

WARNING

- Dangerously high voltages are present inside the TV.
- TV operating voltage: 220 – 240 V AC.

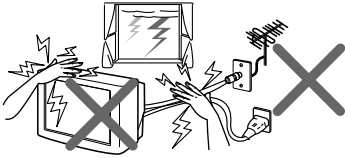

For your own safety, do not touch any part of the TV, the power cord and the antenna cable during lightning storms.



For children's safety, do not leave children alone with the TV. Do not allow children to climb onto it.

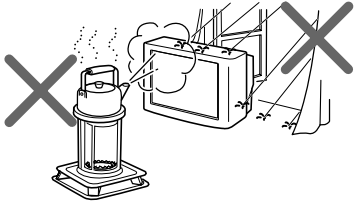

To prevent fire or shock hazard, do not expose the TV to rain or moisture.

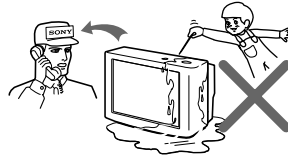

Do not operate the TV if any liquid or solid object falls into it. Have it checked immediately by qualified personnel only.

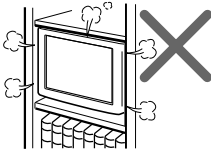

Do not block the ventilation openings of the TV. Do not install the TV in a confined space, such as a bookcase or built-in cabinet.

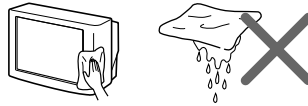

Clean the TV with a dry and soft cloth. Do not use benzine, thinner, or any other chemicals to clean the TV. Do not scratch the picture tube.

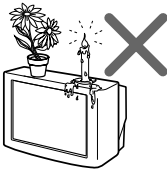

Do not place any objects on the TV.

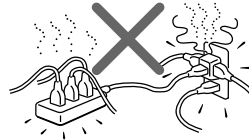

Do not plug in too many appliances to the same power socket. Do not damage the power cord.

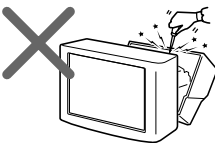

Do not open the cabinet and the rear cover of the TV as high voltages and other hazards are present inside the TV. Refer servicing and disposal of the TV to qualified personnel.

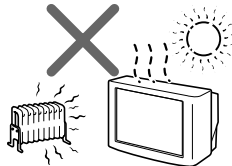

Your TV is recommended for home use only. Do not use the TV in any vehicle or where it may be subject to excessive dust, heat, moisture or vibrations.

Table of Contents

Using Your New TV



Getting Started	4
Step 1: Connect the antenna	4
Step 2: Insert the batteries into the remote	5
Step 3: Preset the channels automatically	5
Connecting optional components	6
Securing the TV	8
Watching the TV	9

Advanced Operations

Selecting the picture and sound modes	12
Viewing your favorite channels	13
Listening with surround sound	14
Enjoying stereo or bilingual programs (KV-XA29M61/XA25M61 only)	15
Viewing Teletext (KV-XA29M61/XA25M61 only)	17

Adjusting Your Setup (MENU)

Introducing the menu system	19
Changing the "PICTURE" setting 	21

Changing the "SOUND" setting 	23
Changing the "SETUP" setting 	25
Changing the Channel Preset ("CH PRESET") setting 	27

Additional Information

Self-diagnosis function	30
Troubleshooting	31
Troubleshooting Shortcuts	34
Overview of controls	36
Specifications	Back cover

WARNING (continued)

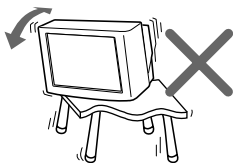

Install the TV on a stable TV stand and floor which can support the TV set weight. Ensure that the TV stand surface is flat and its area is larger than the bottom area of the TV.

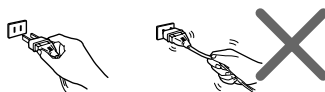

Pull the power cord out by the plug. Do not pull the power cord itself. Even if your TV is turned off, it is still connected to the AC power source (mains) as long as the power cord is plugged in. Unplug the TV before moving it or if you are not going to use it for several days.

Getting Started

CAUTION

- Do not plug in the power cord until you have completed making all other connections; otherwise a minimum leakage current might flow through the antenna and other terminals to ground.
- To avoid battery leakage and damage to the remote, remove the batteries from the remote if you are not going to use it for several days. If any liquid that leaks from the batteries touches you, immediately wash it away with water.

Step 1

Connect the antenna

If you wish to connect a VCR, see the **Connecting a VCR** diagram below.

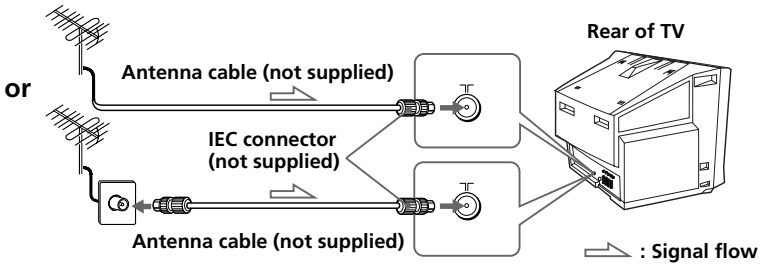





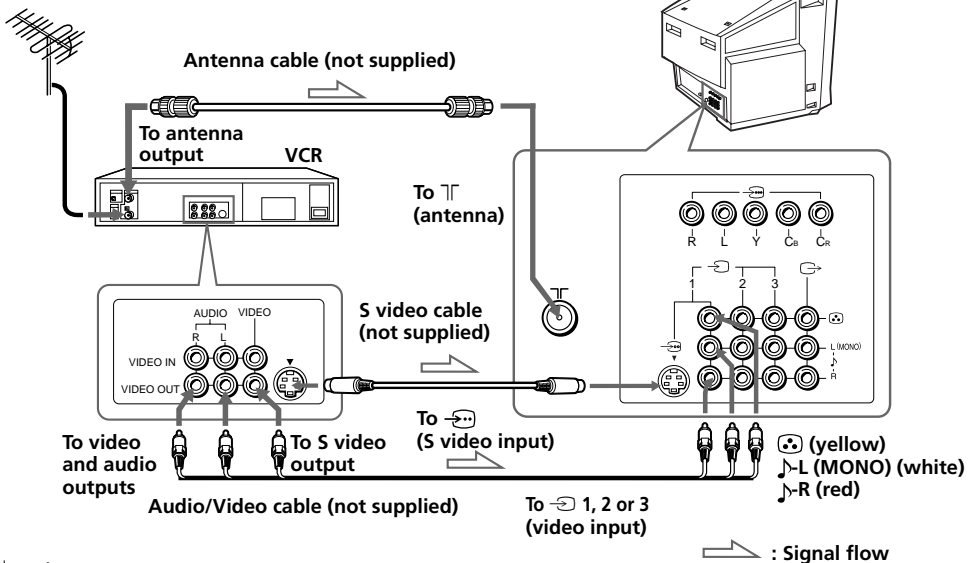



Connecting a VCR

To watch the video input, press (see page 10).



Notes

- If you connect a monaural VCR, connect the yellow plug to  (the yellow jack) and the black plug to -L (MONO) (the white jack).
- If you connect a VCR to the  (antenna) terminal, preset the signal output from the VCR to the program number 0 on the TV.
- If both  (S video input) and  1 (video input) at the rear of your TV are input at the same time, the  (S video input) is automatically selected. To view the video input to  1 (video input), disconnect the S video cable.
- Do not connect video equipment to the  3 (video input) jacks at the front and the rear of your TV at the same time; otherwise the picture will not be displayed properly on the screen.
- When no signal is input from the connected video equipment, the TV screen becomes blue.

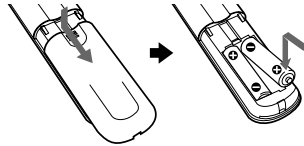
Step 2**Insert the batteries into the remote****Note**

- Do not use old batteries nor use different types of batteries together.

Step 3**Preset the channels automatically**

Front of TV

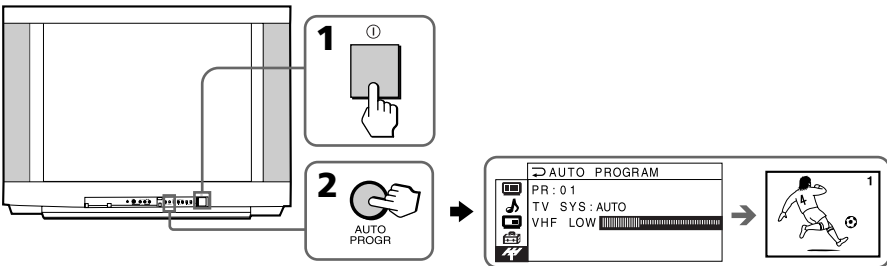
**Tips**

- If you want to stop the automatic channel presetting, press MENU.
- If your TV has preset an unwanted channel or cannot preset a particular channel, then preset your TV manually (see page 28).

Note (KV-XA29M50/XA25M50 only)

- During automatic channel presetting, your TV screen will indicate "B/G", "I", "D/K" or "M" for the TV system ("TV SYS").

Connecting optional components

You can connect optional audio/video components, such as a VCR, multi disc player, DVD, camcorder, video game or stereo system.

To watch the video input of the connected equipment, press \rightarrow (see page 10).

Connecting a camcorder/video game equipment using the \rightarrow (video input) jacks

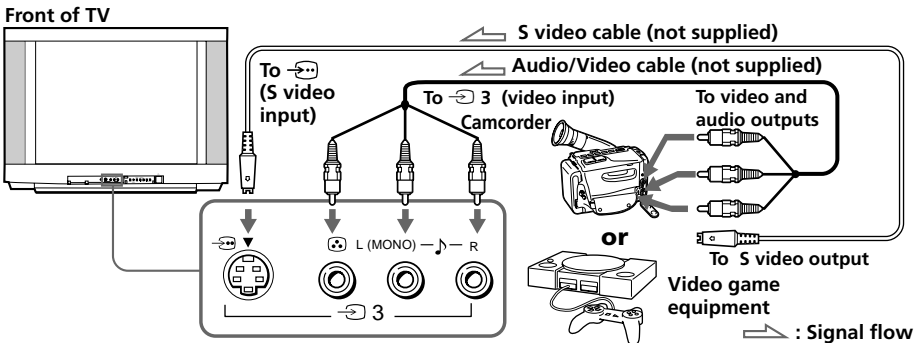

Notes

- You can also connect video equipment to the \rightarrow 1, 2 or 3 (video input) jacks at the rear of your TV.
- If both \rightarrow (S video input) and \rightarrow 3 (video input) at the front of your TV are input at the same time, the \rightarrow (S video input) is automatically selected. To view the video input to \rightarrow 3 (video input), disconnect the S video cable.
- Do not connect video equipment to the \rightarrow 3 (video input) jacks at the front and the rear of your TV at the same time; otherwise the picture will not be displayed properly on the screen.

Connecting audio/video equipment using the \rightarrow (monitor output) jacks

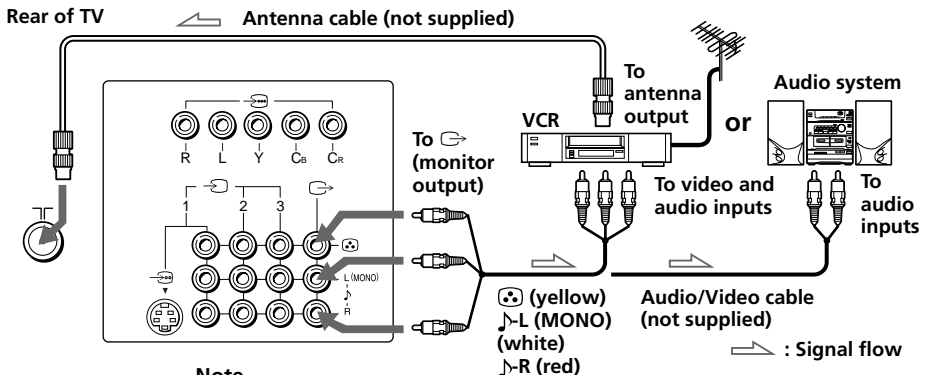



Note

- If you select "DVD" on your TV screen, no signal will be output at the \rightarrow (monitor output) jacks (see page 10).

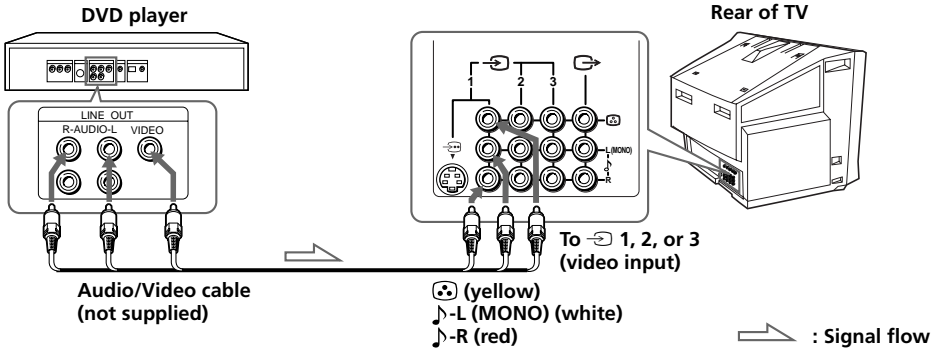
Connecting a DVD player using the (video input) jacks



Connecting a DVD player using the (component video input) jacks

- 1 Connect R and L under  (component video input) on your TV to the LINE OUT, AUDIO R and L output connectors on your DVD player.
- 2 Using a component video cable, connect Y, C_B, and C_R under  (component video input) on your TV to the COMPONENT VIDEO OUT Y, C_B, and C_R output connectors on your DVD player.

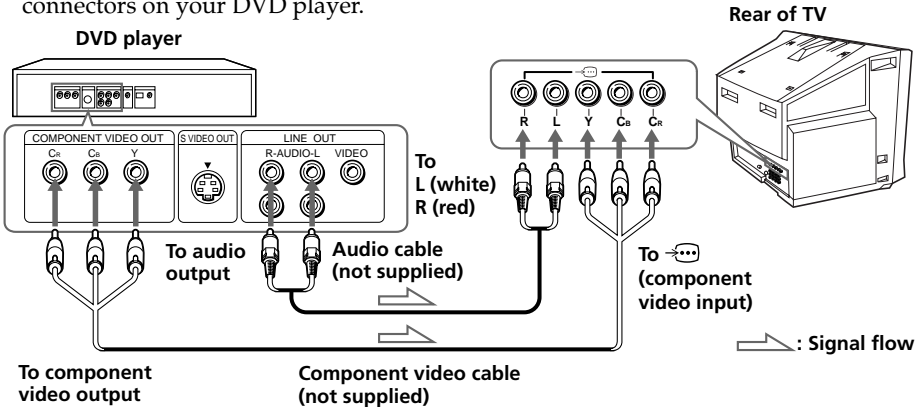

Notes

- If your DVD player can output interlace and progressive mode signals, select the interlace output when connecting to  (component video input) on your TV. Your TV can receive either 525i/60Hz or 625i/50Hz interlace signals.
- Some DVD player terminals may be labeled differently:

Connect	To (on the DVD player)
Y (green)	Y
C _B (blue)	C _B , B-Y or P _B
C _R (red)	C _R , R-Y or P _R

- Since the high quality pictures on a DVD disc contain a lot of information, picture noise may appear. In this case, adjust the sharpness ("SHARP") in the "ADJUST" menu of the "PICTURE MODE" menu (see page 22).

Securing the TV

To prevent the TV from falling, secure the TV using one of the following methods:

A With the supplied screws, attach the band to the TV stand and to the rear of the TV using the provided hole.

or

B Put the cord or chain through the clamps to secure the TV against a wall or pillar.

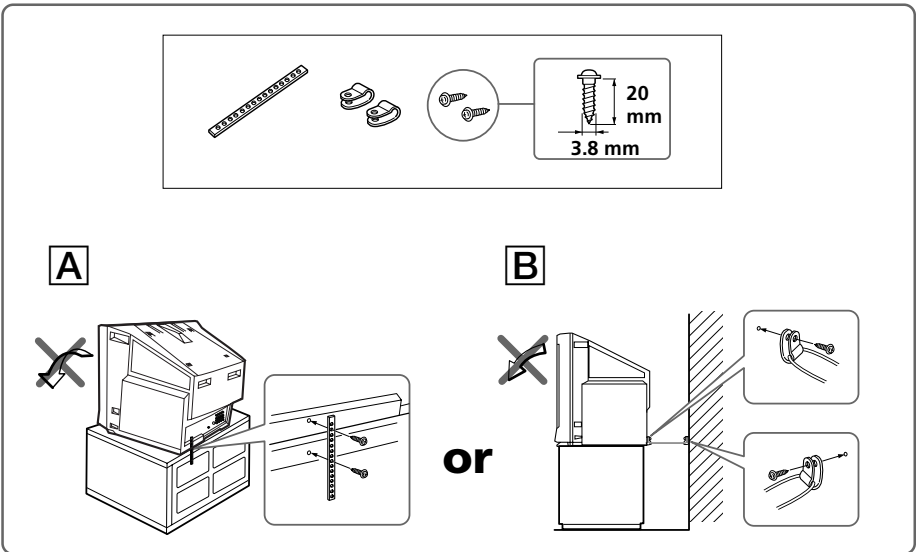

Watching the TV

This section explains various functions and operations available while watching the TV. Most operations can be done using the remote.

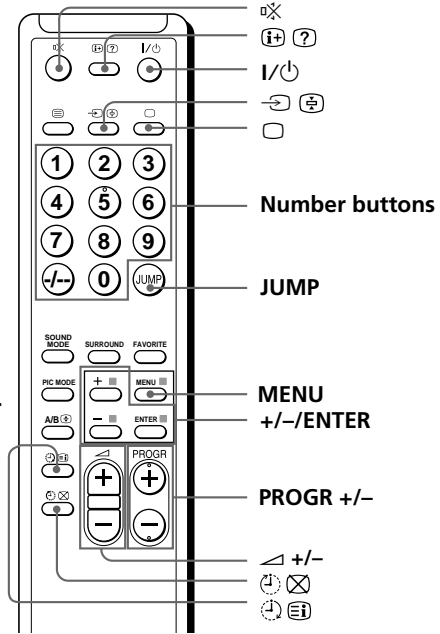
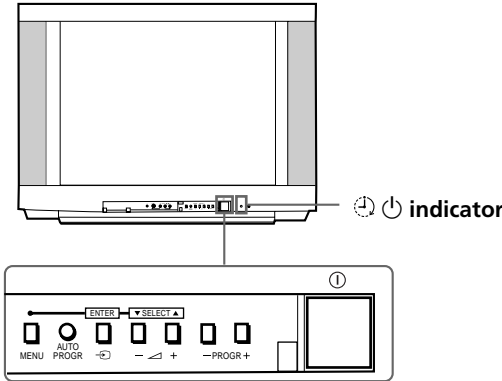

1 Press ① to turn on the TV.

When the TV is in the standby mode (the  indicator on the TV is lit red), press I/⏻ on the remote or PROGR +/- on the TV.



2 Press PROGR +/- or number buttons to select the program number.

For double digit numbers, press -/-, then the number (e.g., for 25, press -/-, then 2 and 5).

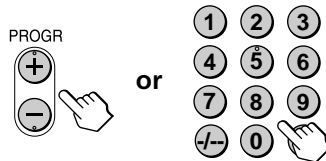

To select a program number quickly

- (1) Press and hold PROGR +/-.
- (2) Release PROGR +/- when the desired program number appears.

Note

- When you select a program number quickly, the picture may be disrupted. This does not indicate a malfunction.

continued

Watching the TV (continued)

Additional tasks

To	Press
Turn off temporarily	I/⏻. The ⏻ indicator on the TV lights up red.
Turn off completely	Ⓛ on the TV.
Adjust the volume	⏮ + / -.
Mute the sound	⏸.
Watch the video input (VCR, camcorder, etc.)	⏮ to select "VIDEO 1", "VIDEO 2", "VIDEO 3" or "DVD". To return to the TV program, press Ⓛ (or ⏮ on the TV).
Jump back to the previous program number	JUMP.
Display the on-screen information*	ⓘ.

* The picture, sound, and either the program number or video input are displayed. The on-screen display for the picture and sound information disappears after about three seconds.

Changing the menu language

You can change the menu language as well as the on-screen language.

For details on how to use the menu, see **Introducing the menu system** on page 19.

1 Press MENU.

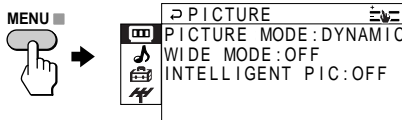

2 Press + or - to select the "SETUP" icon (⚙️), then press ENTER.

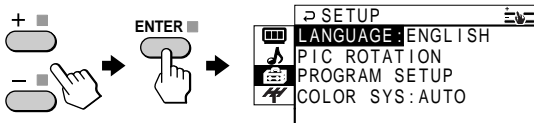

3 Make sure "LANGUAGE" is selected, then press ENTER.

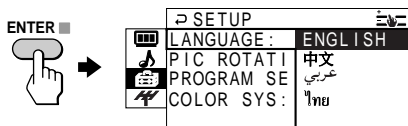

4 Press + or - to select the desired language (e.g., "中文"), then press ENTER.

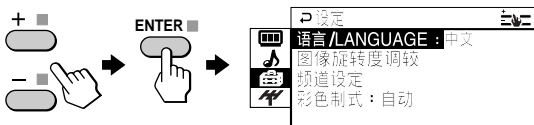

The selected menu language appears.



To return to the normal screen

Press MENU.

Setting the Wake Up timer

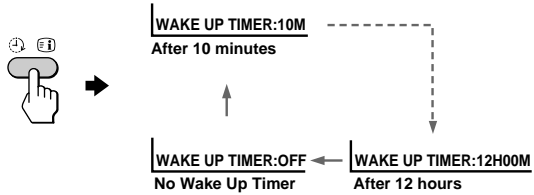
- 1** Press  until the desired period of time appears.
The Wake Up timer starts immediately after you have set it.



- 2** Select the program number or video input you want to display when you wake up.
- 3** Press  or set the Sleep timer if you want the TV to turn off automatically.
The  indicator on the TV lights up orange.

To cancel the Wake Up timer

Press  until "WAKE UP TIMER: OFF" appears or turn off the TV's main power.

Note

- If no buttons or controls are pressed for more than two hours after the TV is turned on using the Wake Up timer, the TV automatically goes into the standby mode. To continue watching the TV, press any button or control on the TV or the remote.

Setting the Sleep timer

Press  until the desired period of time appears.
The Sleep timer starts immediately after you have set it.

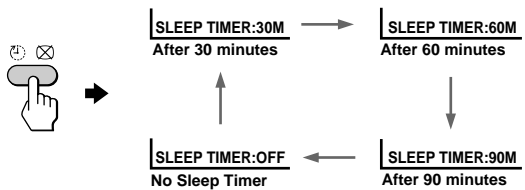

To cancel the Sleep timer

Press  until "SLEEP TIMER: OFF" appears or turn the TV off.

Selecting the picture and sound modes

You can select picture and sound modes and adjust the setting to your preference in "PERSONAL" option.

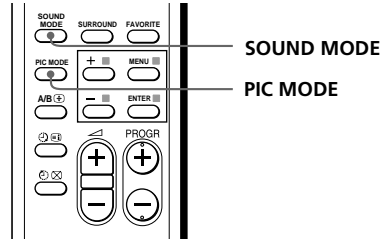

Selecting the picture mode

Press PIC MODE repeatedly until you get the desired picture mode.

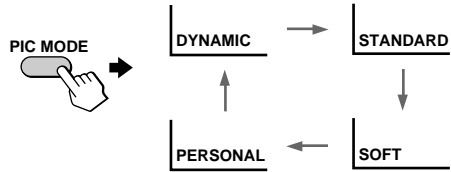

Select	To
"DYNAMIC"	view high contrast pictures.
"STANDARD"	view normal contrast pictures.
"SOFT"	view mild pictures.
"PERSONAL"	receive the last adjusted picture setting from the "ADJUST" option in the "PICTURE" menu (see page 21).

Selecting the sound mode

Press SOUND MODE repeatedly until you get the desired sound mode.

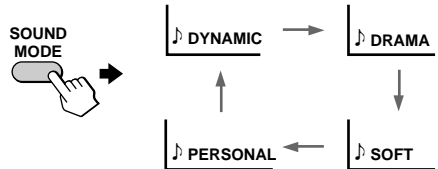

Select	To
"DYNAMIC"	listen to dynamic and clear sound that emphasizes the low and high tones.
"DRAMA"	listen to sound that emphasizes voice and high tones.
"SOFT"	listen to soft sound.
"PERSONAL"	receive the last adjusted sound setting from the "ADJUST" option in the "SOUND" menu (see page 23).

Tip

- You can also set the picture and sound modes using the menu (see **Changing the "PICTURE" setting** on page 21 and **Changing the "SOUND" setting** on page 23).

Viewing your favorite channels

You can display and select six of your favorite channels directly from your TV screen.

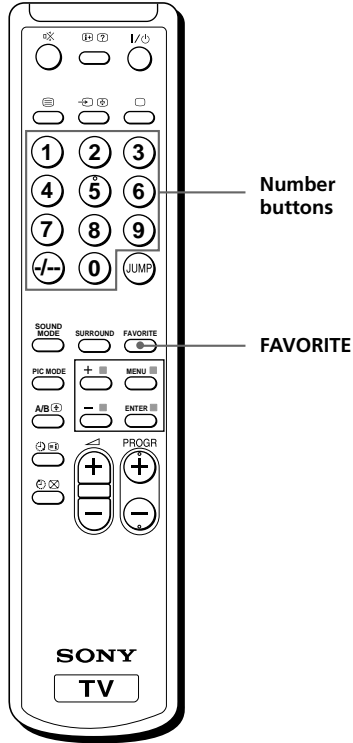

1 Press FAVORITE.

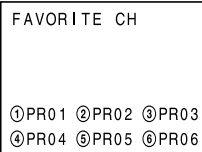

2 Press the number button from 1 to 6 to select the desired favorite channel.

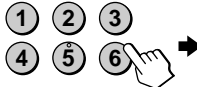

Tip

- To program your favorite channels, see **Adjusting each program number settings (PROGRAM SETUP)** on page 26.

Listening with surround sound

The surround feature enables you to enjoy the sound effects of a concert hall or movie theater.

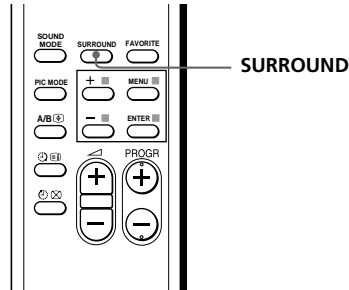

Press SURROUND repeatedly until you receive the desired surround sound.

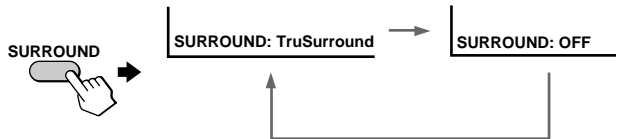

Select	To
"TruSurround"	listen to the surround sound that spreads out to the rear of a room.
"OFF"	turn off the surround sound.

Tip

- You can also select the surround option using the menu (see **Changing the "SOUND" setting** on page 23).

The surround of your TV is categorized as TruSurround.

TruSurround™ is a trademark of SRS Labs, Inc. SRS and the SRS symbol are registered trademarks of SRS Labs, Inc. in the United States and selected foreign countries. SRS and TruSurround are incorporated under license from SRS Labs, Inc. and are protected under United States Patent Nos. 4,748,669 and 4,841,572 with numerous additional issued and pending foreign patents.

Enjoying stereo or bilingual programs

(KV-XA29M61/XA25M61 only)

You can enjoy stereo sound or bilingual programs of NICAM and A2 stereo systems.

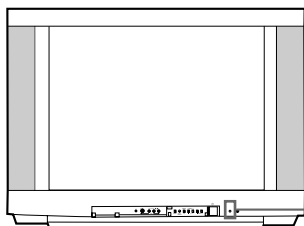

○ indicator

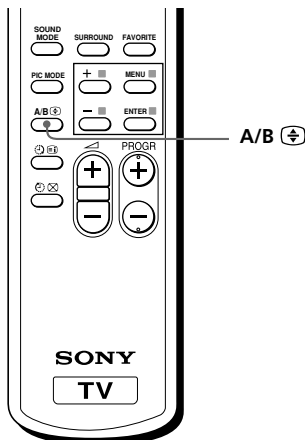

Press A/B repeatedly until you receive the sound you want.

The on-screen display changes to show the selected sound. The ○ indicator on the TV lights up red when receiving any stereo or bilingual program.

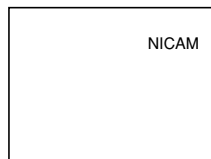

When receiving a NICAM program

Broadcasting	On-screen display (Selected sound)
NICAM stereo	
NICAM bilingual	
NICAM monaural	

continued

Enjoying stereo or bilingual programs (continued)

When receiving an A2 program

Broadcasting	On-screen display (Selected sound)
A2 stereo	
A2 bilingual	

Receiving area for NICAM and A2 programs

System	Receiving area
NICAM	Hong Kong, Singapore, New Zealand, Malaysia, Thailand, etc.
A2	Australia, Malaysia, Thailand, etc.

Notes

- If the signal is very weak, the sound becomes monaural automatically.
- If the stereo sound is noisy when receiving a NICAM program, select "MONO". The sound becomes monaural, but the noise is reduced.

If the sound is distorted when receiving a monaural program through the \square (antenna) terminal

Press A/B repeatedly until "MONO" appears on the screen.

To cancel the monaural sound setting, press A/B again until "AUTO" appears on the screen.



Notes

- The "MONO" or "AUTO" setting is memorized for each program number.
- You cannot receive stereo broadcast signal when the TV is in the "MONO" setting. Normally set the TV to "AUTO".

Viewing Teletext

(KV-XA29M61/XA25M61 only)

TV stations broadcast an information service called Teletext via some TV channels. Teletext allows you to receive various information, such as shares market or news.

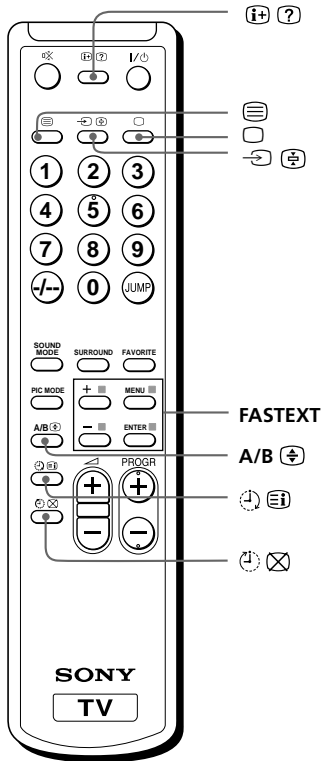

Displaying Teletext

- 1 Select a TV channel that carries the Teletext broadcast you want to watch.
- 2 Press to display the text.

A Teletext page (normally the index page) is displayed. If there is no Teletext broadcast, "100" is displayed at the top left corner of the screen.

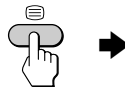

P166 SECTEXT 166 FR1 MAR 03:59:00			
TRAVEL			
From Singapore	Day	Dep/Arr	Flight Aircraft
To PARIS	1 4	2200/0958	SG28 747
	2	2130/1225	PA115 115
	3	2115/1530	SG56 747
To OSAKA	2 5	1000/1715	SG6 747
	4 8	0930/2015	CR522 L16
To ROMA	2 7	2130/0745	SG24 747
	4	2300/0915	AZ487 747
To SYDNEY	1	2210/0610	SG21A 747
	2	2100/0835	SG21A 747













To turn off Teletext

Press .

continued

Viewing Teletext (continued)

Additional Teletext tasks

To	Do this
display a Teletext page on the TV picture	Press  . Each time you press  , the screen changes as follows: Teletext → Teletext and TV → TV.
check the contents of a Teletext service	Press  . An overview of the Teletext contents and page numbers appear on the screen.
select a Teletext page	Press the number buttons to enter the three-digit page number of the desired Teletext page.* If you make a mistake, reenter the correct page number. To access the next or previous page, press PROGR +/- .
hold (pause) a Teletext display	Press  to display the symbol "  " at the top left corner of the screen. To resume normal Teletext operation, press  or  .
reveal concealed information (e.g., an answer to a quiz)	Press  . To conceal the information, press the button again.
enlarge the Teletext display	Press  . Each time you press  , the Teletext display changes as follows: Enlarge upper half → Enlarge lower half → Normal size.
wait for a Teletext page while watching a TV program	<ol style="list-style-type: none">1 Enter the Teletext page number that you want to refer to, then press .2 When the page number is displayed, press  to show the text.

* You can also select a Teletext page that appears in the colored columns at the bottom of the screen using the corresponding color-coded buttons on the remote.

Using FASTEXT

This feature allows you to quickly access a Teletext page that uses FASTEXT. When a FASTEXT program is broadcasted, the colored menus appear at the bottom of the screen. The colors of the menus correspond to the red, green, yellow, and blue color-coded buttons on the remote.





To access a FASTEXT menu

Press the color-coded button on the remote corresponding to the menu you want. The menu page appears on the screen after several seconds.

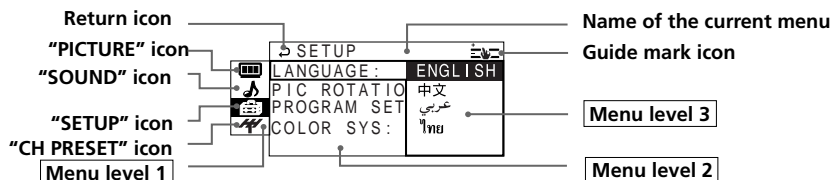
Introducing the menu system

The MENU button lets you open a menu and change the settings of your TV. Here's an overview of the menu system.



Level 1	Level 2	Level 3/Function
	"PICTURE MODE"	Select the picture mode: "DYNAMIC" → "STANDARD" → "SOFT" → "PERSONAL" → "ADJUST"
	"ADJUST"	Adjust the "PERSONAL" option: "PICTURE" → "COLOR" → "BRIGHT" → "HUE" → "SHARP"
	"WIDE MODE"	Change the picture size.
	"INTELLIGENT PIC"	Optimize picture quality.
	"SOUND MODE"	Select the sound mode: "DYNAMIC" → "DRAMA" → "SOFT" → "PERSONAL" → "ADJUST"
	"ADJUST"	Adjust the "PERSONAL" option: "BASS" → "TREBLE" → "BALANCE" → "BBE"*
	"SURROUND"	Select the surround mode: "TruSurround" → "OFF"
	"INTELLIGENT VOL"	Adjust volume automatically.
	"LANGUAGE"	Change the menu language: "ENGLISH" → "中文"(Chinese) → "عربي"(Arabic) → "ไทย"(Thai)
	"PIC ROTATION"	Rotate the picture.
	"PROGRAM SETUP"	Adjust each program number settings.
	"COLOR SYS"	Change the color system: "AUTO" → "PAL" → "SECAM" → "NTSC3.58" → "NTSC4.43"
	"AUTO PROGRAM"	Preset channels automatically.
	"MANUAL PROGRAM"	Preset channels manually.
	"TV SYS"	Change the TV system: "B/G" → "I" → "D/K" → "M"

* The BBE is manufactured by Sony Corporation under license from BBE Sound, Inc. It is covered by U.S. Patent No. 4,638,258 and No. 4,482,866. The word "BBE" and the BBE symbol are the trademarks of BBE Sound, Inc.

continued

Introducing the menu system (continued)

How to use the menu

You can use the buttons on the remote and on the TV as well to display the menu and adjust the settings.

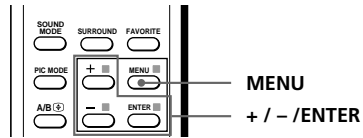

- 1 Press MENU to display the menu.

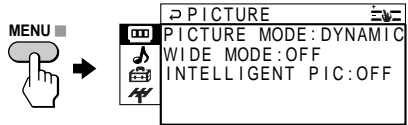

- 2 Press + or - to select the desired item.



- 3 Press ENTER to confirm your selection and go to the next menu level.

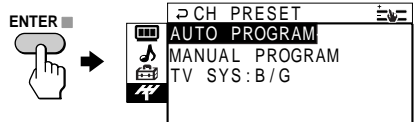

Other menu operations

To	Press
Adjust the setting value	+/-
Return to the previous menu level	ENTER
Cancel the menu	MENU

Tips

- To return from Menu Level 2 to Menu Level 1, press +/- to select the return icon (↩), then press ENTER.
- Some of the menu items can be operated directly using the remote buttons.
- The MENU, ENTER, and SELECT ▼/▲ buttons on the TV can also be used for the operations above.

Front of TV

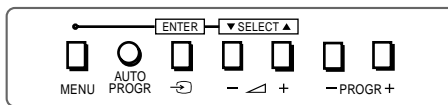

Note

- If more than 60 seconds elapse between entries, the menu screen automatically disappears.

Changing the “PICTURE” setting

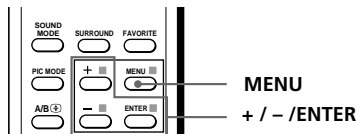

The “PICTURE” menu allows you to change the picture settings.

1 Press MENU.

2 Make sure the “PICTURE” icon () is selected, then press ENTER.

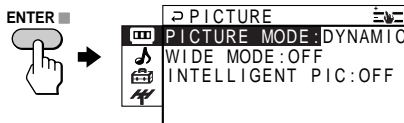

3 Press + or – to select the desired item (e.g., “PICTURE MODE”), then press ENTER.

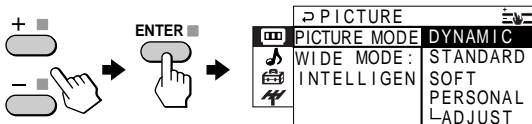

Select	To
“PICTURE MODE”	choose either “DYNAMIC”, “STANDARD”, “SOFT”, “PERSONAL”*, or “ADJUST”.
“WIDE MODE”	change the picture size when receiving wide-mode (16:9) picture signal. Press + or – to select “ON”, then press ENTER. To cancel, select “OFF”, then press ENTER.
“INTELLIGENT PIC”	optimize picture quality. Press + or – to select “ON”, then press ENTER. To cancel, select “OFF”, then press ENTER.

* When the “PERSONAL” mode is selected, you can receive the last adjusted picture settings from the “ADJUST” option (see page 22).

Note

- For details on the options under “PICTURE MODE”, see page 12.

To return to the normal screen

Press MENU.

continued

Changing the "PICTURE setting" (continued)

Adjusting the "ADJUST" items under "PICTURE MODE"

- 1** Press + or – to select the desired item (e.g., "COLOR"), then press ENTER.

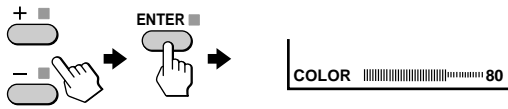

- 2** Adjust the value according to the following table, then press ENTER.

For	Press – to	Press + to
"PICTURE"	decrease picture contrast	increase picture contrast
"COLOR"	decrease color intensity	increase color intensity
"BRIGHT"	darken the picture	brighten the picture
"HUE"*	increase red picture tones	increase green picture tones
"SHARP"	soften the picture	sharpen the picture

* You can adjust "HUE" for the NTSC color system only.

- 3** Repeat the above steps to adjust other items.
The adjusted settings will be received when you select "PERSONAL".
-

Tip

- For details on the menu system and how to use the menu, refer to **Introducing the menu system** on page 19.

Changing the "SOUND" setting

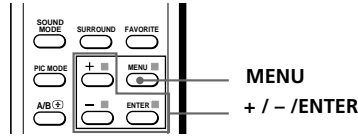

The "SOUND" menu allows you to change the sound settings.

1 Press MENU.

2 Press + or – to select the "SOUND" icon (🔊), then press ENTER.

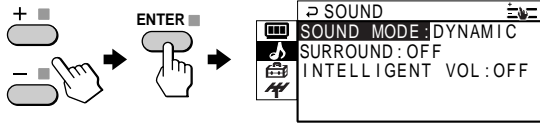

3 Press + or – to select the desired item (e.g., "SOUND MODE"), then press ENTER.

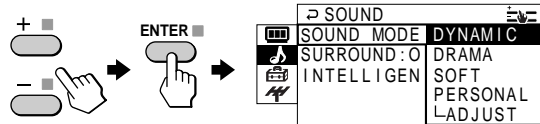

Select	To
"SOUND MODE"	choose either "DYNAMIC", "DRAMA", "SOFT", "PERSONAL"*, or "ADJUST".
"SURROUND"	choose either "TruSurround" or "OFF".
"INTELLIGENT VOL"	adjust the volume of all program numbers and video inputs automatically. Press + or – to select "ON", then press ENTER. To cancel, select "OFF", then press ENTER.

* When the "PERSONAL" mode is selected, you can receive the last adjusted sound settings from the "ADJUST" option (see page 24).

Tip

- For details on the options under "SOUND MODE" and "SURROUND", see pages 12 and 14 respectively.

To return to the normal screen

Press MENU.

continued

Changing the "SOUND" setting (continued)

Adjusting the "ADJUST" items under "SOUND MODE"

- 1** Press + or – to select the desired item (e.g., "BALANCE"), then press ENTER.



- 2** Adjust the value according to the following table, then press ENTER.

For	Press – to	Press + to
"BASS"	decrease the bass	increase the bass
"TREBLE"	decrease the treble	increase the treble
"BALANCE"	increase the left speaker's volume	increase the right speaker's volume
"BBE"	select "HIGH" for higher enhancement of sound clarity; select "LOW" for lower enhancement of sound clarity; select "OFF" to turn off the BBE sound	

- 3** Repeat the above steps to adjust other items.

The adjusted settings will be received when you select "PERSONAL".

Tip

- For details on the menu system and how to use the menu, refer to **Introducing the menu system** on page 19.

Changing the "SETUP" setting

The "SETUP" menu allows you to change the menu language, adjust the picture position, adjust the program number setting and select color system.

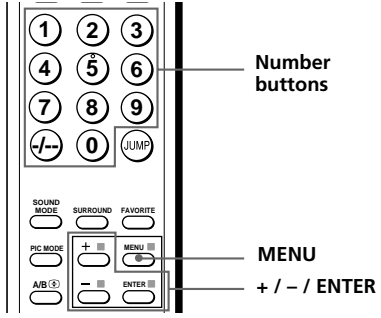

1 Press MENU.

2 Press + or - to select "SETUP" icon (), then press ENTER.

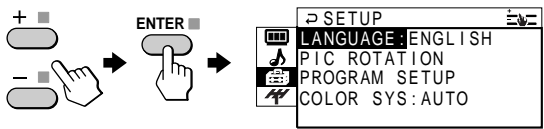

3 Press + or - to select the desired item (e.g., "COLOR SYS"), then press ENTER.

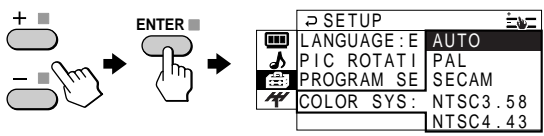

Select	To
"LANGUAGE"	change the menu language (see Changing the menu language on page 10).
"PIC ROTATION"	adjust the picture position when it is not aligned to the TV screen. Press + or - to adjust the picture position, then press ENTER.
"PROGRAM SETUP"	adjust each program number settings (see Adjusting each program number settings (PROGRAM SETUP) on page 26).
"COLOR SYS"	change the color system. Normally, set this to "AUTO".



To return to the normal screen

Press MENU.

continued

Changing the "SETUP" setting (continued)

Adjusting each program number settings (PROGRAM SETUP)

1 Select "PROGRAM SETUP" from the "SETUP" menu.

2 Select "PR" and press ENTER. Press + or - to select the desired program number you want to adjust, then press ENTER.

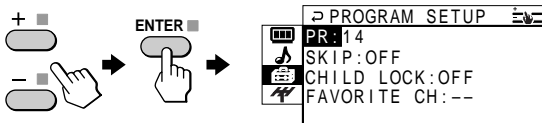

3 Press + or - to select the desired item (e.g., "CHILD LOCK"), then press ENTER.

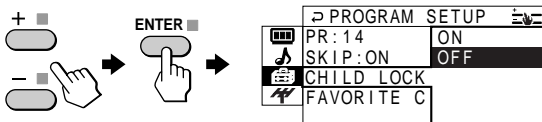

Select	To
"PR"	select the desired program number.
"SKIP"	skip unwanted or unused program number. Press + or - to select "ON", then press ENTER. To cancel, select "OFF", then press ENTER.
"CHILD LOCK"	prevent children from watching this selected program number. Press + or - to select "ON", then press ENTER. The lock symbol (🔒) appears on the screen. To cancel, select "OFF", then press ENTER. If you preset a locked program number, that particular program number will be unlocked automatically.
"FAVORITE CH"	program favorite channels for direct selection. Press + or - to select one of the six favorite channel numbers (if you decide not to make any changes, select "↶"), then press ENTER. To view the selected favorite channel, refer page 13.

4 To continue adjusting other program number, press + or - to select "PR", then repeat step 2 and 3.

To return to the normal screen

Press MENU.

Changing the Channel Preset ("CH PRESET") setting

The "CH PRESET" menu allows you to adjust the setup of your TV. For example, you can receive a channel with a weak signal that fails to be tuned in by automatic presetting.

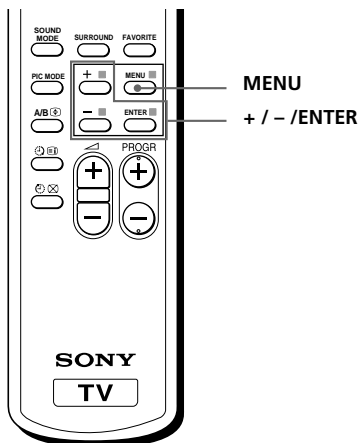

1 Press MENU.

2 Press + or - to select the "CH PRESET" icon (📺), then press ENTER.

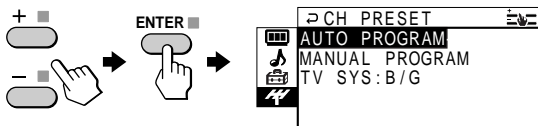

3 Press + or - to select the desired item (e.g., "AUTO PROGRAM"), then press ENTER.

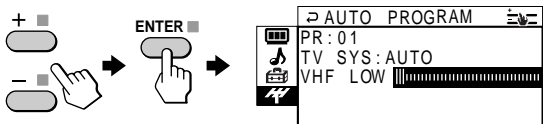

Select	To
"AUTO PROGRAM"	preset channels automatically.
"MANUAL PROGRAM"	preset channels manually (see Presetting channels manually on page 28).
"TV SYS"	change the TV system. Press + or - to select either "B/G", "I", "D/K" or "M", then press ENTER.

To return to the normal screen

Press MENU.

Tip

- For details on the menu system and how to use the menu, refer to **Introducing the menu system** on page 19.

continued

Changing the Channel Preset ("CH PRESET") setting (continued)

Presetting channels manually

1 After selecting "MANUAL PROGRAM", select the program number to which you want to preset a channel.

(1) Make sure "PR" is selected, then press ENTER.

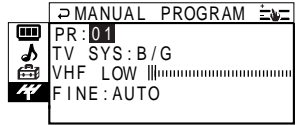

(2) Press + or - until the program number you want to preset (e.g., program number "10") appears on the menu, then press ENTER.

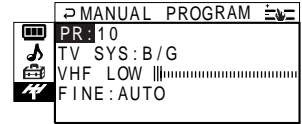
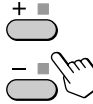

2 Select the desired channel.

(1) Make sure either "VHF LOW", "VHF HIGH" or "UHF" is selected, then press ENTER.

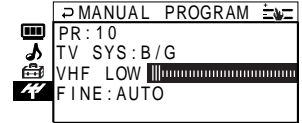
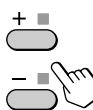

(2) Press + or - until the desired channel picture appears on the TV screen, then press ENTER.

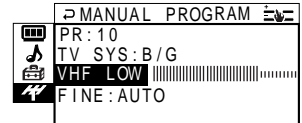
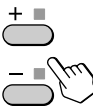

3 If the sound of the desired channel is abnormal, select the appropriate TV system.

(1) Press + or - to select "TV SYS", then press ENTER.

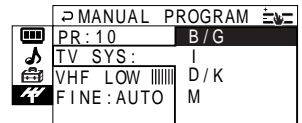
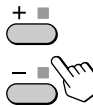

(2) Press + or - until the sound becomes normal (e.g., "M"), then press ENTER.

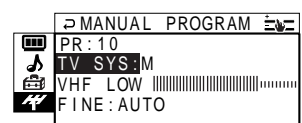
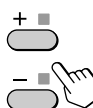

4 If you are not satisfied with the picture and sound quality, you may improve them by using fine tuning.

- (1) Press + or – to select “FINE”, then press ENTER.

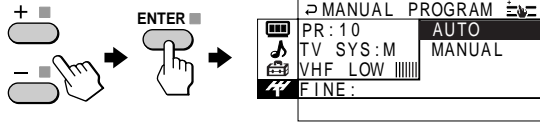

- (2) Press + or – to select “MANUAL”, then press ENTER.

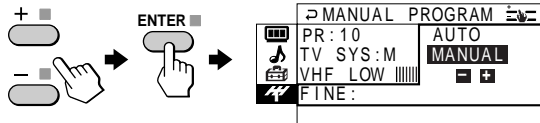

- (3) Press + or – until the picture and sound quality are optimal, then press ENTER.

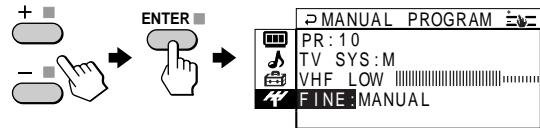

The + or – icon on the menu flashes while tuning.

To return to the normal screen

Press MENU.

Notes

- If you preset a locked program number (“CHILD LOCK”), that particular program number will be unlocked automatically (see page 26).
- The TV system (“TV SYS”) and the fine tuning (“FINE”) settings are memorized for each program number.

Self-diagnosis function



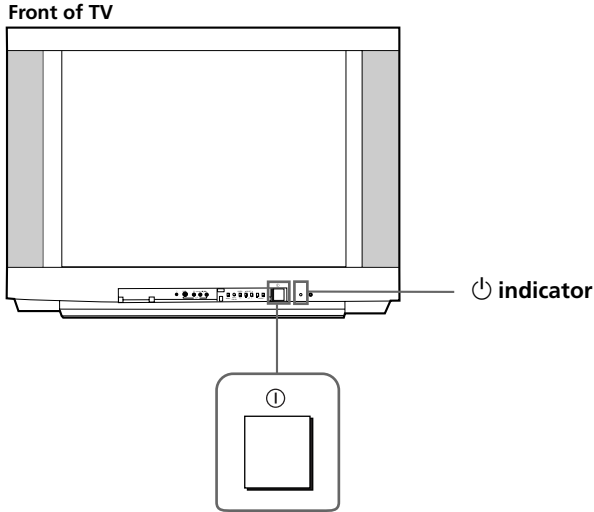





Your TV is equipped with a self-diagnosis function. If there is a problem with your TV, the ⏻ indicator flashes red. The number of times the ⏻ indicator flashes indicates the possible causes.

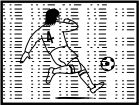

- 1** Check that the ⏻ indicator flashes red a number of times between 3-second intervals.
- 2** Count the number of times the ⏻ indicator flashes.
- 3** Press ⏻ (main power) to turn off your TV.
- 4** Inform your nearest Sony service center about the number of times the ⏻ indicator flashes.
Be sure to note the model name and serial number located on the rear of your TV.







Troubleshooting

If you find any problem while viewing your TV, please check the following guide. If any problem persists, contact your Sony dealer .

Symptom	Possible cause	Solutions	Page
Snowy picture 	<ul style="list-style-type: none"> • Connection is loose or the cable is damaged. • Channel presetting is inappropriate or incomplete. 	<ul style="list-style-type: none"> • Check the antenna cable and connection on the TV, VCR and on the wall. • Display the "CH PRESET" menu and select "MANUAL PROGRAM" to preset the channel again. 	<p>4</p> <p>28</p>
Noisy sound 	<ul style="list-style-type: none"> • The antenna type is inappropriate. • The antenna direction is inappropriate. • Signal transmission is low. 	<ul style="list-style-type: none"> • Check the antenna type ("VHF"/"UHF"). Contact a Sony dealer for advice. • Adjust the antenna direction. Contact a Sony dealer for advice. • Try using a booster. 	<p>-</p> <p>-</p> <p>-</p>
Distorted picture 	<ul style="list-style-type: none"> • Broadcast signals are too strong. 	<ul style="list-style-type: none"> • Turn off or disconnect the booster if it is in use. 	<p>-</p>
Noisy sound 			
Good picture 	<ul style="list-style-type: none"> • The TV system setting or channel presetting is inappropriate or incomplete. 	<ul style="list-style-type: none"> • If the sound of all the channels are noisy, display the "CH PRESET" menu and check the TV system ("TV SYS") setting, then select "AUTO PROGRAM" to preset the channels again. • If the sound of some channels are noisy, select the channel, then display the "CH PRESET" menu and select the appropriate TV system ("TV SYS"). 	<p>27</p> <p>27</p>
Noisy sound 			
No picture 	<ul style="list-style-type: none"> • The power cord, antenna or VCR is not connected. • The TV is not turned on. 	<ul style="list-style-type: none"> • Check the power cord, antenna and the VCR connections. • Press I/⏻ (power). • Press Ⓛ (main power) on the TV to turn off the TV for about five seconds, then turn it on again. 	<p>4</p> <p>9</p> <p>9</p>
No sound 			

continued

Troubleshooting (continued)

Symptom	Possible cause	Solutions	Page
Good picture 	<ul style="list-style-type: none"> The volume level is too low. 	<ul style="list-style-type: none"> Press \triangleleft + to increase the volume level. 	10
	<ul style="list-style-type: none"> The sound is muted. 	<ul style="list-style-type: none"> Press \otimes to cancel the muting. 	10
	<ul style="list-style-type: none"> Broadcast signal has a transmission problem. 	<ul style="list-style-type: none"> Press A/B until a good sound is heard. (KV-XA29M61/XA25M61 only) 	15
No sound 			
Dotted lines or stripes 	<ul style="list-style-type: none"> There is local interference from cars, neon signs, hair dryers, power generators, etc. 	<ul style="list-style-type: none"> Do not use a hair dryer or other equipment near the TV. Adjust the antenna direction for minimum interference. Contact a Sony dealer for advice. 	–
			–
Double images or "ghosts" 	<ul style="list-style-type: none"> Broadcast signals are reflected by nearby mountains or buildings. 	<ul style="list-style-type: none"> Use a highly directional antenna. Use the fine tuning ("FINE") function. 	–
	<ul style="list-style-type: none"> The antenna direction is inappropriate. 	<ul style="list-style-type: none"> Adjust the antenna direction. Contact a Sony dealer for advice. 	–
	<ul style="list-style-type: none"> Use of a booster is inappropriate. 	<ul style="list-style-type: none"> Turn off or disconnect the booster if it is in use. 	–
No color 	<ul style="list-style-type: none"> The color level setting is too low. 	<ul style="list-style-type: none"> Display the "PICTURE" menu and select "ADJUST" of "PICTURE MODE", then adjust the "COLOR" level. 	22
	<ul style="list-style-type: none"> The color system setting is inappropriate. 	<ul style="list-style-type: none"> Display the "SETUP" menu and check the color system ("COLOR SYS") setting (usually set this to "AUTO"). 	25
	<ul style="list-style-type: none"> The antenna direction is inappropriate. 	<ul style="list-style-type: none"> Adjust the antenna direction. Contact a Sony dealer for advice. 	–
Abnormal color patches 	<ul style="list-style-type: none"> The magnetic disturbance from external speakers or other equipment, or the direction of the earth's magnetic field may affect the TV. 	<ul style="list-style-type: none"> Keep external speakers or other electrical equipment away from the TV. Do not move the TV while the TV is turned on. Press $\text{\textcircled{1}}$ (main power) on the TV to turn off the TV for about five minutes, then turn it on again. 	–
TV cannot receive stereo broadcast signal. (KV-XA29M61/XA25M61 only)	<ul style="list-style-type: none"> The stereo reception setting is inappropriate. 	<ul style="list-style-type: none"> Press A/B until "AUTO" appears on the screen. 	15

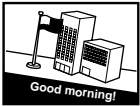
Symptom	Possible cause	Solutions	Page
Stereo broadcast sound switches on and off or is distorted. OR The sound switches between monaural and stereo frequently. (KV-XA29M61/XA25M61 only)	<ul style="list-style-type: none"> • Connection is loose or the cable is damaged. 	<ul style="list-style-type: none"> • Check the antenna cable and connection on the TV, VCR and on the wall. 	4
	<ul style="list-style-type: none"> • The antenna direction is inappropriate. 	<ul style="list-style-type: none"> • Adjust the antenna direction. Contact a Sony dealer for advice. 	–
	<ul style="list-style-type: none"> • Broadcast signal has a transmission problem. 	<ul style="list-style-type: none"> • Press A/B until a good sound is heard. 	15
“100” appears on the top of the screen and no Teletext display. (KV-XA29M61/XA25M61 only)	<ul style="list-style-type: none"> • The channel carries no Teletext broadcast. 	—	17
Teletext display is incomplete (picture snowy or double images). (KV-XA29M61/XA25M61 only)	<ul style="list-style-type: none"> • Connection is loose or the cable is damaged. 	<ul style="list-style-type: none"> • Check the antenna cable and connection on the TV, VCR and on the wall. 	4
	<ul style="list-style-type: none"> • The antenna direction is inappropriate. 	<ul style="list-style-type: none"> • Adjust the antenna direction. Contact a Sony dealer for advice. 	–
	<ul style="list-style-type: none"> • Signal transmission is too low. 	<ul style="list-style-type: none"> • Try using a booster. 	–
Picture slant 	<ul style="list-style-type: none"> • The magnetic disturbance from external speakers or other equipment, or the direction of the earth's magnetic field may affect the TV. 	<ul style="list-style-type: none"> • Keep external speakers or other electrical equipment away from the TV. 	–
		<ul style="list-style-type: none"> • Display the “SETUP” menu and adjust “PIC ROTATION” until the picture position is optimal. 	25
Lines moving across the TV screen.	<ul style="list-style-type: none"> • There is interference from external sources, e.g., heavy machineries, nearby broadcast station. 	<ul style="list-style-type: none"> • Use the fine tuning (“FINE”) function. 	29
The ⏻ indicator on your TV flashes red a number of times between 3-second intervals.	<ul style="list-style-type: none"> • Your TV may need service. 	<ul style="list-style-type: none"> • Contact your nearest Sony service center. 	30
TV cabinet creaks.	<ul style="list-style-type: none"> • Changes in room temperature sometimes make the TV cabinet expand or contract, making a noise. This does not indicate a malfunction. 	—	–
A “boom” sound is heard when the TV is turned on.	<ul style="list-style-type: none"> • The TV's demagnetizing function is working. This does not indicate a malfunction. 	—	–

Troubleshooting Shortcuts

For better viewing, please check the following connections.

Antenna connection

UHF

VHF

Check the antenna direction.

Incorrect antenna direction may cause:

- Snowy picture
- Distorted picture
- Noisy/distorted sound



Wall antenna terminal

Booster

VCR

Check the antenna type.

Wrong type of antenna may cause:

- No picture



- Snowy picture



Check connection on the wall antenna terminal.

Loose connection may cause:

- Snowy picture



- Distorted sound



Check if you need booster to increase signal level.

Too strong signal level may cause:

- Distorted picture



- Noisy sound



- Double image picture



- Missing Teletext characters



(KV-XA29M61/
XA25M61 only)

Connection to TV

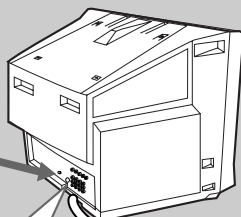

Check connection on the VCR and on the TV.

Loose connection may cause:

- Snowy picture

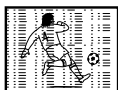

- Distorted sound



- No picture

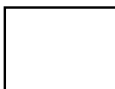

AC Connection

Check connection on the AC socket.

Loose connection may cause:

- no power
- no picture with no sound



For more information, see **Troubleshooting** on page 31 or consult your dealer for guidance.

Overview of controls

TV front panel

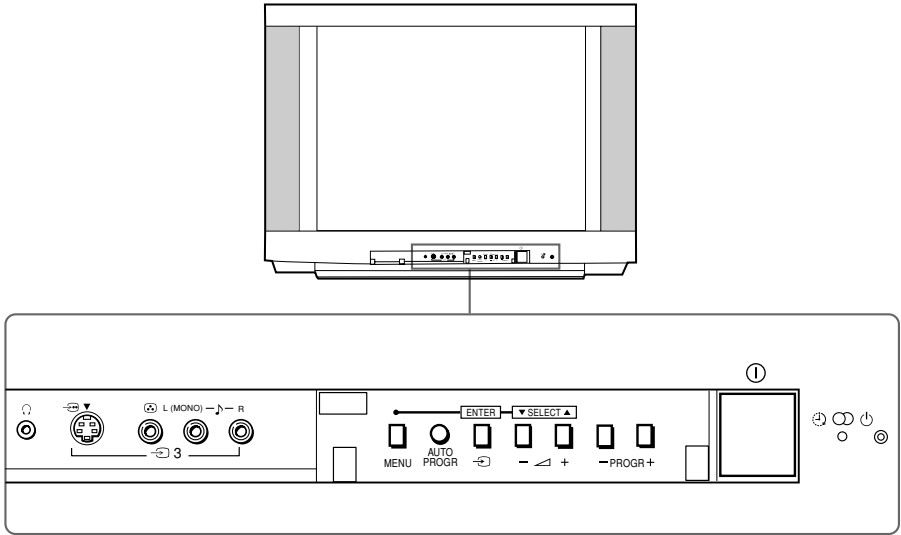

Button	Function	Page
AUTO PROGR	Preset channels automatically.	5
①	Turn off completely or turn on the TV.	9
PROGR +/-	Select program number.	9
⏻	Standby indicator	9
🔊 +/-	Adjust volume.	10
📺	Select TV or video input.	10
🕒	Wake Up indicator	11
🔊	Stereo/bilingual indicator.	15
(KV-XA29M61/XA25M61 only)		
Menu operations		
MENU	Display the menu.	20
SELECT ▼/▲	Select and adjust item.	20
ENTER	Confirm selected item.	20
🎧	Headphones jack.	-

Remote control

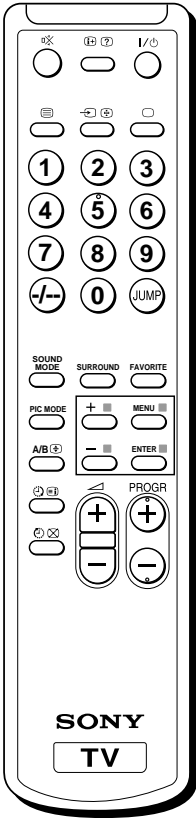





Names/symbols of buttons on the remote are indicated in different colors to represent the available functions.

Label color	Button function
White	For general TV operations
Green	For Teletext operations

Button	Function	Page
I/⏻	Turn off temporarily or turn on the TV.	9
PROGR +/-	Select program number.	9
0 - 9, +/-	Input numbers.	9
⏮ +/-	Adjust volume.	10
↺	Select TV or video input.	10
□	Display the TV program.	10
⏸	Mute the sound.	10
ⓘ+	Display on-screen information.	10
JUMP	Jump to previous program number.	10
Timer operations		
⌚	Set TV to turn on automatically.	11
⌚	Set TV to turn off automatically.	11
PIC MODE	Select picture mode.	12
SOUND MODE	Select sound mode.	12
FAVORITE	Display favorite channels.	13
SURROUND	Select surround mode.	14
Stereo/bilingual operations (KV-XA29M61/XA25M61 only)		
A/B	Select stereo/bilingual mode.	15
Teletext operations (KV-XA29M61/XA25M61 only)		
☰	Display Teletext broadcast.	17
⊕	Enlarge the Teletext display.	18
?	Reveal concealed information.	18
⊞	Stop Teletext display from scrolling.	18
☰	Display Teletext service contents.	18
⊗	Show TV screen while waiting for Teletext page.	18
0 - 9	Input Teletext page number.	18
PROGR +/-	Display the next or previous page.	18
■ (red, green, yellow, blue)	Access a Fastext menu	18
Menu operations		
MENU	Display the menu.	20
+ or -	Select and adjust item.	20
ENTER	Confirm selected item.	20

Specifications

	KV-XA25M61 KV-XA25M50	KV-XA29M61 KV-XA29M50	Note
Power requirements	220 – 240 V AC, 50/60 Hz		
Power consumption (W)	Indicated on the rear of the TV		
Television system	B/G, I, D/K, M		
Color system	PAL, PAL 60, SECAM, NTSC4.43, NTSC3.58		
Stereo/Bilingual system	NICAM Stereo/Bilingual B/G, I, D/K; A2 Stereo/Bilingual B/G		KV-XA29M61/ XA25M61 only
Teletext language	English, Arabic, French		KV-XA29M61/ XA25M61 only
Channel coverage			
B/G	VHF : E2 to E12 UHF : E21 to E69 CATV : S01 to S03, S1 to S41		
I	UHF : B21 to B68 CATV : S01 to S03, S1 to S41		
D/K	VHF : C1 to C12, R1 to R12 UHF : C13 to C57, R21 to R60 CATV : S01 to S03, S1 to S41, Z1 to Z39		
M	VHF : A2 to A13 UHF : A14 to A79 CATV : A-8 to A-2, A to W+4, W+6 to W+84		
⌚ (Antenna)	75-ohm external terminal		
Audio output (Speaker)	8W + 8W		
Number of terminal			
 (Video)	Input: 4* Output: 1 Phono jacks; 1 Vp-p, 75 ohms		* Three input lines available
 (Audio)	Input: 4* Output: 1 Phono jacks; 500mVrms		* Three input lines available
 (S Video)	Input: 2 Y: 1 Vp-p, 75 ohms unbalanced, sync negative C: 0.286 Vp-p, 75 ohms		
 (Component Video)	Input: 1 Phono jacks; 1 Vp-p, 75 ohms, Y: 1 Vp-p, 75ohms, sync negative CB: 0.7 Vp-p, 75 ohms CR: 0.7 Vp-p, 75 ohms		
 (Headphones)	Output: 1 Stereo minijack		
Picture tube	25 in.	29 in.	
Tube size (cm)	64	72	Measured diagonally
Screen size (cm)	60	68	Measured diagonally
Dimensions (w/h/d, mm)	696 × 513 × 500		772 × 576 × 516
Mass (kg)	38		51

Design and specifications are subject to change without notice.