

SONY[®]

4-204-616-67



Trinitron Colour Television

Instruction Manual



GB

KV-28DS60U
KV-28DS65U
KV-32DS60U
KV-32DS65U

©1999 by Sony Corporation Printed in UK

NOTICE FOR CUSTOMERS IN THE UNITED KINGDOM

A molded plug complying with BS1363 is fitted to this equipment for your safety and convenience.

Should the fuse in the plug supplied need to be replaced, a 5 AMP fuse approved by ASTA or BSI to BS 1362 (i.e. marked with  or ) must be used.

When an alternative type of plug is used it should be fitted with a 5 AMP FUSE, otherwise the circuit should be protected by a 5 AMP FUSE at the distribution board.

If the plug supplied with this equipment has a detachable fuse cover, be sure to attach the fuse cover after you change the fuse. Never use the plug without the fuse cover. If you should lose the fuse cover, please contact your nearest Sony service station.

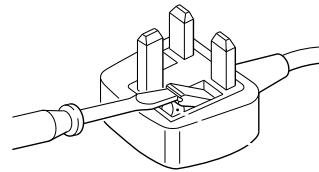

How to replace the Fuse

Open the fuse compartment with a blade screwdriver, and replace the fuse.

- **IMPORTANT**

If the plug supplied is not suitable for the socket outlet in your home, it should be cut off and an appropriate plug fitted in accordance with the following instructions:

The wires in this mains lead are coloured in accordance with the following code:

Blue Neutral

Brown Live

As the colours of the wires in the mains lead of this apparatus may not correspond with the coloured markings identifying the terminals in your plug, proceed as follows:

The wire which is coloured blue must be connected to the terminal which is marked with the letter N or coloured black. The wire which is coloured brown must be connected to the terminal which is marked with the letter L or coloured red. Do not connect either wire to the earth terminal in the plug which is marked by the letter E or by the safety earth symbol  or coloured green or green and yellow.

WARNING

- To prevent shock hazard, do not insert the plug cut off from the mains lead into a socket outlet. This plug cannot be used and should be destroyed.
- To prevent fire or shock hazard, do not expose the unit to rain or moisture.
- Dangerously high voltages are present inside the set. Do not open the cabinet. Refer servicing to qualified personnel only.

General operation of your remote control

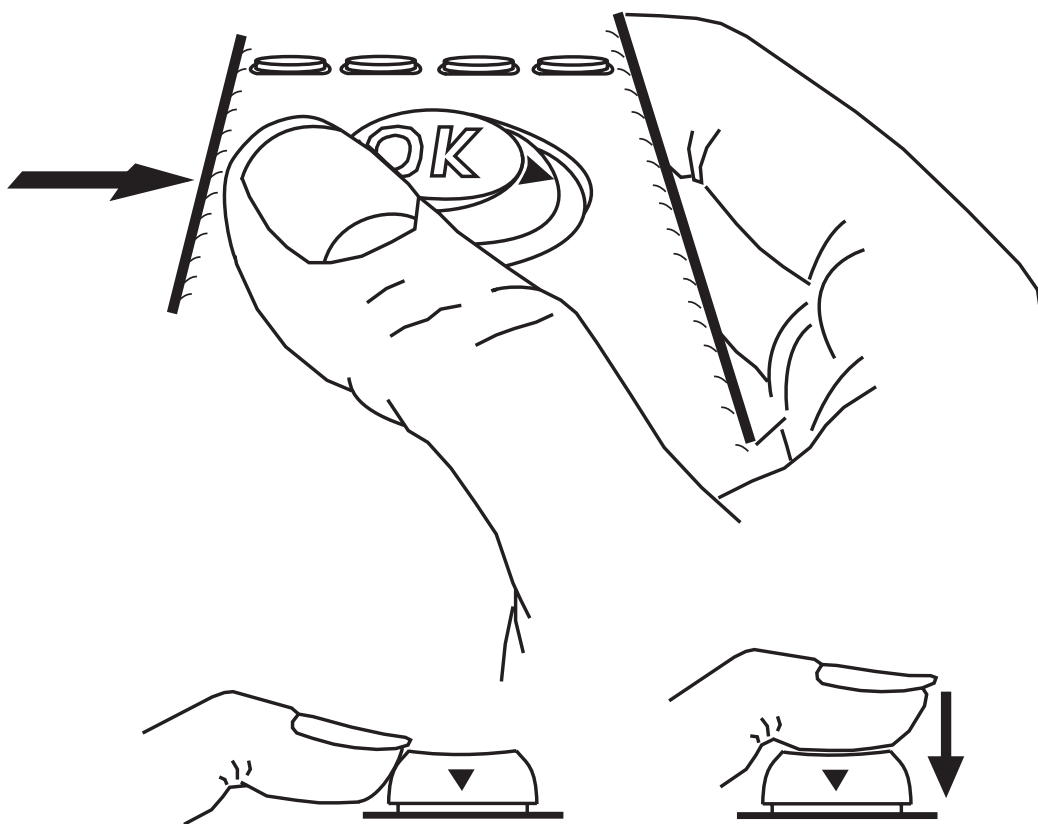

HOW TO MOVE
THE 'OK' BUTTON

HOW TO PRESS
THE 'OK' BUTTON

Table of contents

Safety First	4
Quick Start Guide	5
Checking the accessories supplied	5
Inserting batteries into the remote control	5
Connecting the speakers	6
Connecting the aerial	8
Switching on the TV	8
Automatically tuning the TV	9
Viewing digital or analogue channels	10
Overview	11
Overview of the TV set buttons	11
Overview of the remote control buttons	12
Additional TV Features	13
Adjusting the picture	13
Changing picture and sound modes quickly	13
Adjusting the sound	14
Setting up Dolby ProLogic	15
Changing the screen mode	16
Exchanging programme positions	17
Using the parental lock	18
Using Further Programme Preset	19
Adjusting the picture rotation	20
Displaying subtitles for digital channels	21
Using the sleep timer	22
Manually tuning the TV	23
Skipping programme positions	24
Adjusting the TV picture for an RGB source	25
Teletext	26
Viewing standard teletext	26
Viewing digital teletext	28
Electronic Programme Guide (EPG)	29
Displaying the EPG	29
Viewing information on the EPG	29
Recording programmes	30
Setting the manual timer	31
Optional Equipment	32
Connecting equipment to the TV	32
Additional information when connecting equipment	33
Selecting the output source for the scart socket F	33
Using Smartlink	34
Additional Information	35
Specifications	35
Troubleshooting	36

Safety First

Safety Information

Televisions operate on extremely high voltages. To prevent fire or electric shock, please follow the safety procedures indicated below. For your own safety, never open the cabinet. Refer servicing to qualified personnel only.

For General Safety

- Do not expose the TV set to rain or moisture.
- Do not remove the rear cover.

For Safe Installation

- Do not install the TV in hot, humid or excessively dusty places.
- Do not block or cover the ventilation openings. For ventilation, leave a space of at least 10 cm all around the set.
- Do not install the TV where it may be exposed to mechanical vibrations.

For Safe Operation

- Do not operate the TV set on anything other than a 220-240V AC, 50Hz supply.
- Unplug the TV if any liquid or solid objects fall in through the ventilation slots. Have it checked immediately.
- Do not disconnect the TV by pulling on the power cable. Disconnect by removing the mains plug.

Caution

Do not knock or rub on the tube face with sharp or hard objects. Remove finger prints only with a soft cloth dampened with glass cleaner. Do not use any abrasive cleaners!

Quick Start Guide

Follow steps 1-7 to:

- Check the accessories supplied
- Insert batteries into your remote control
- Connect the speakers to your TV
- Connect the aerial to your TV
- Plug in and switch on the TV
- View programmes on your TV

1. Checking the accessories supplied

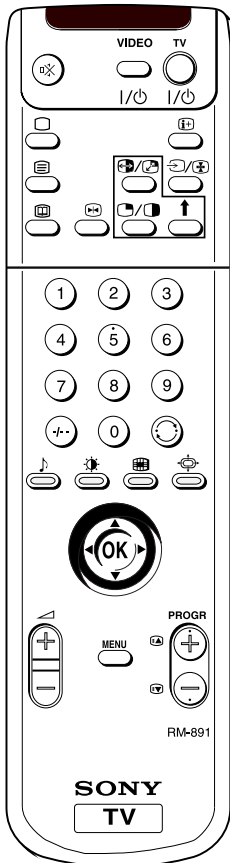

Remote Control

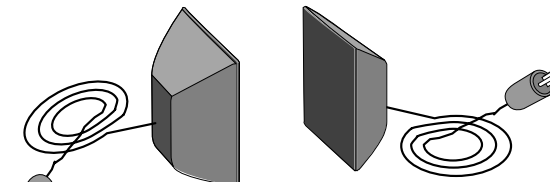

Surround Speakers

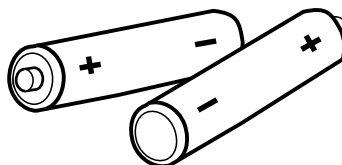

Batteries

Note: The remote control supplied may be type RM-892.
However, the operating function of each button will be the same.

2. Inserting batteries into the remote control

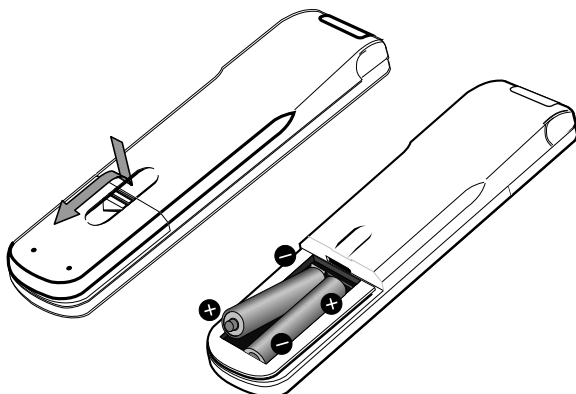

Always remember to dispose of used batteries in an environmental friendly way.

3.1. Connecting the speakers

- ! Before switching on the TV, you need to connect the speakers to the TV using the leads provided. The striped lead is for the red terminal of the speaker; the black lead for the black terminal.

Dolby* ProLogic Surround normally requires 5 speakers:

Centre Speaker (incorporated in the TV) - to anchor the stable sound image, like dialogues, to the TV screen.

Left and Right Front Speakers (incorporated in the TV) - for the normal two channel stereo or bilingual broadcasts.

Surround Speakers - for the special effects created by the surround channels.

a) To connect the speakers provided:

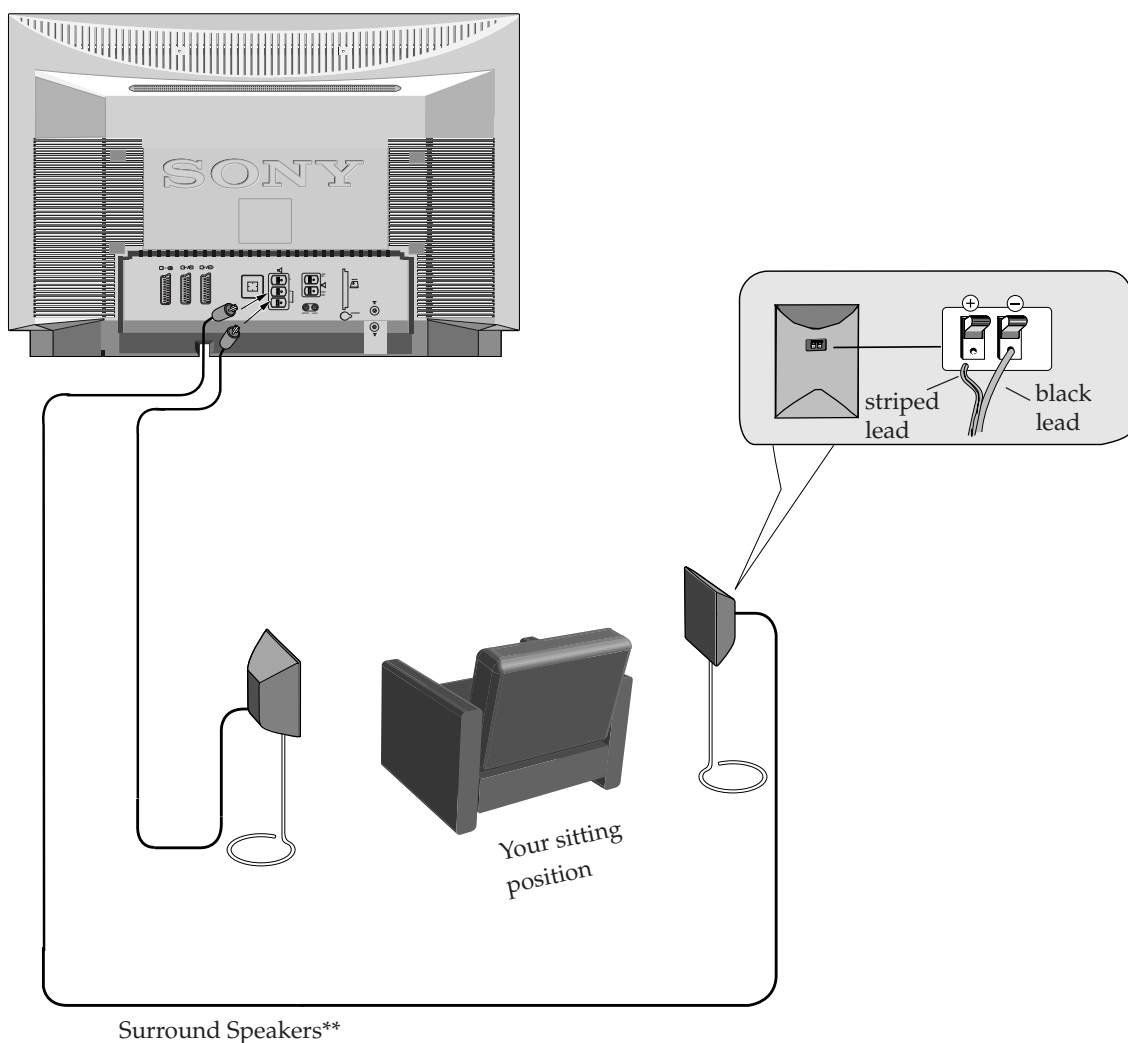

* Manufactured under licence from Dolby Laboratories Licensing Corporation. "Dolby", "ProLogic" and the double-D symbol are trademarks of Dolby Laboratories Licensing Corporation.

** For the best sound effect place the surround speakers one meter above your listening position.

3.2. Connecting the speakers

- b) To connect your own speakers (when using your own speakers, make sure they are at least 4 ohms impedance and magnetically shielded):

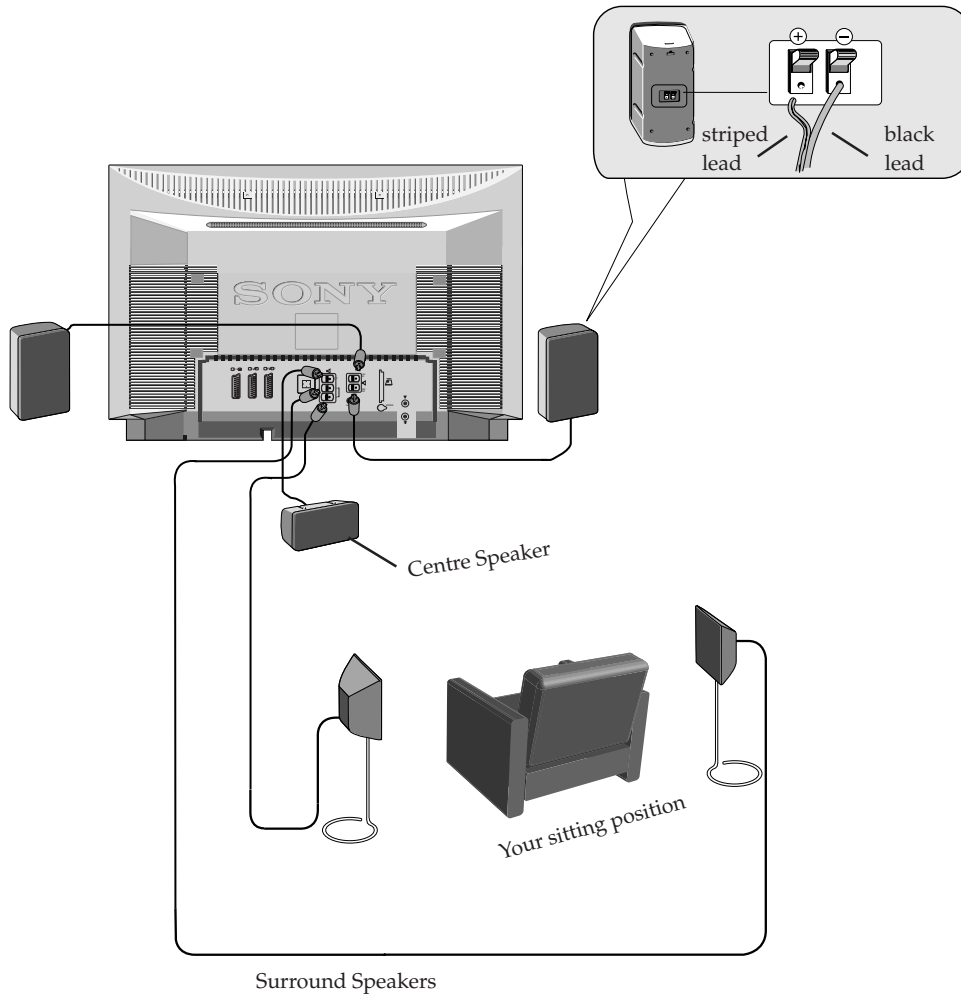

4. Connecting the aerial

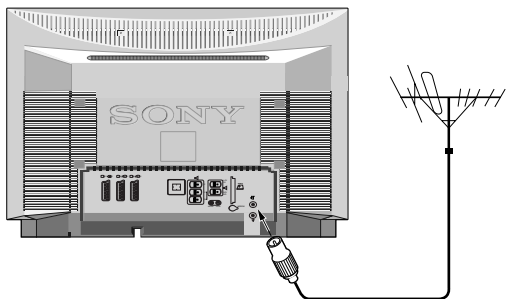

Connect a conventional aerial to the socket marked  on the rear of the TV.

5. Switching on the TV

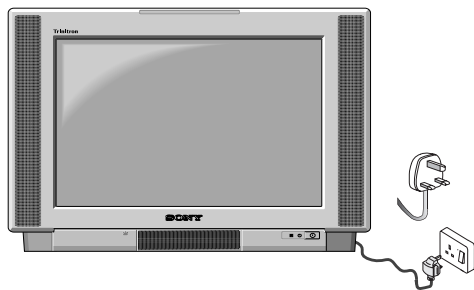

Connect the TV plug to the mains socket (220-240V AC, 50Hz) and switch on.

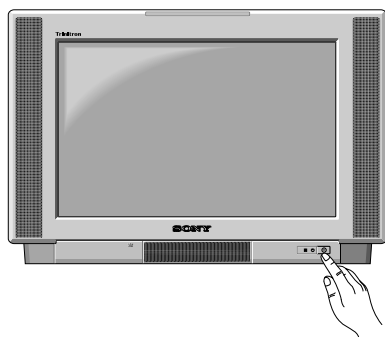

Push in the **on/off** switch on the front of the TV.

6. Automatically tuning the TV

You can tune the TV to receive the new digital channels and/or the traditional analogue channels. If at any time during this procedure you want to return to the normal TV picture, press the MENU button.

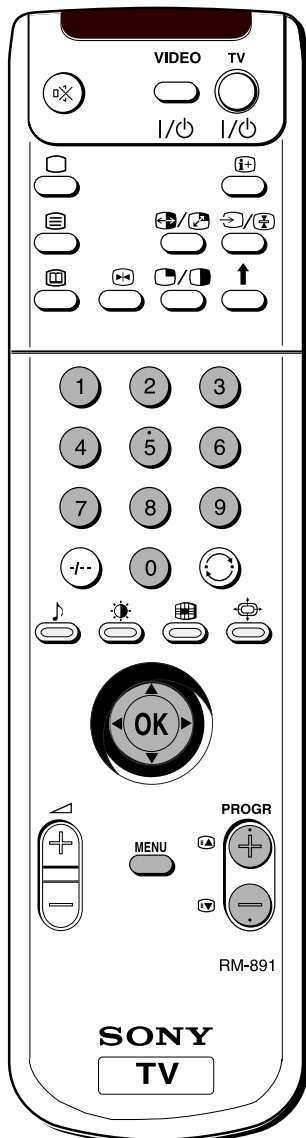
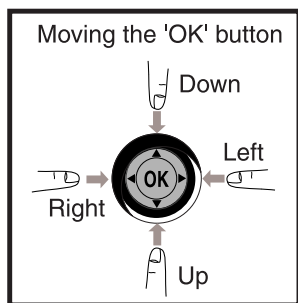

- 1 Press the MENU button on the remote control to display the menu on the TV screen.
- 2 Move the OK button on the remote control DOWN to select the  symbol on the menu screen then move RIGHT to enter the 'PRESET' menu.
- 3 Move the OK button DOWN to select "Programme Setup" then move RIGHT to enter the 'PROGRAMME SETUP' menu.
- 4 Move the OK button RIGHT to highlight the brackets then move repeatedly DOWN to select 'Digital' if you wish to view digital channels or 'Analogue' if you wish to view analogue channels.
- 5 Press the OK button to confirm then move LEFT to display the PRESET menu.
- 6 Move the OK button UP to select 'Auto Programme' then move the OK button RIGHT to display the "AUTO PROGRAMME" menu.
- 7 Press the OK button to start the automatic tuning process. The word 'searching' now flashes on the menu screen and the TV starts to store all available channels. When tuning digital channels, please be patient and do not press any buttons as the tuning process takes approximately twenty minutes depending on the number of channels.
- 8 When the autotune procedure is complete, the PRESET menu appears on the screen and the channel currently being broadcast on programme 1 is displayed.
- 9 If you wish to tune in both the digital channels and the analogue channels, repeat steps 3-8, remembering to change your selection in step 4.
- 10 Press the MENU button to remove the 'PRESET' menu from the TV screen.

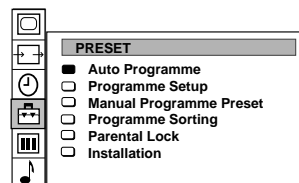
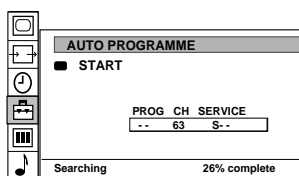
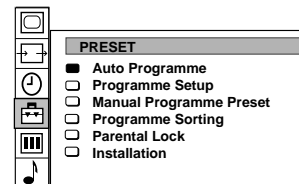
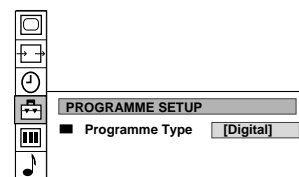
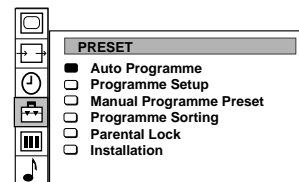
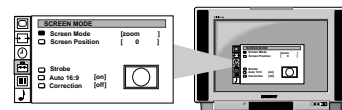

- Notes:**
- If you wish to stop the "autotune" procedure, press the OK button then the MENU button on the remote control.
 - If, after tuning is complete, no digital programme is displayed on the TV, repeat steps 1-10 but select 'Analogue' in the Programme Setup menu screen. When digital programmes become available in your area, repeat steps 1-10 above and select 'Digital' in the Programme Setup menu screen.

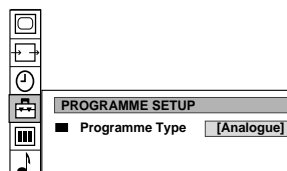

7. Viewing digital or analogue channels

Once you have tuned in the new digital channels and/or the traditional analogue channels, you have the option to view the digital or analogue channels using the TV menu system or the channel table.

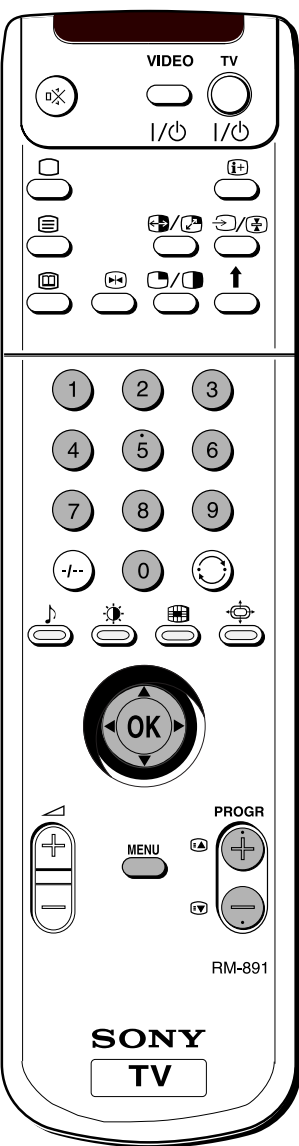
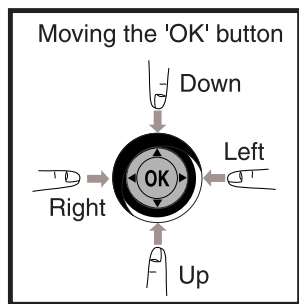

Using the TV menu system

- 1 Press the MENU button on the remote control to display the menu on the TV screen.
- 2 Move the OK button on the remote control DOWN to select the symbol on the menu screen then move RIGHT to enter the 'PRESET' menu.
- 3 Move the OK button DOWN to select 'Programme Setup' then move RIGHT to enter the 'PROGRAMME SETUP' menu.
- 4 Move the OK button RIGHT to highlight the brackets then move repeatedly DOWN to select 'Digital' if you wish to view digital channels or 'Analogue' if you wish to view analogue channels.
- 5 Press the OK button to confirm your selection.
- 6 Press the MENU button to remove the menu from the TV screen.
- 7 You can now change channel using one of the following methods:
 - a) **Using the PROGR+/- button**
Press the PROGR+/- buttons on your remote control to change channels up or down, one at a time.
 - b) **Using the channel number**
If you know the channel number, you can use the numbered buttons on your remote control to key in the number.

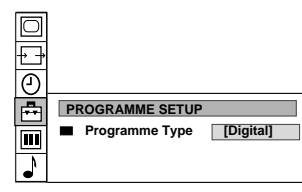
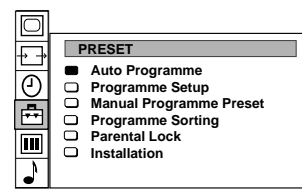
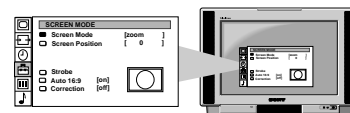

Using the channel table

- 1 Press the OK button on the remote control to display the channel table on the TV screen.
- 2 Move the joystick UP or DOWN to select 'View' then move RIGHT to highlight the brackets.
- 3 Move the OK button UP or DOWN to select 'Analogue' if you wish to view analogue channels or 'Digital' if you wish to view digital channels.
- 4 Press the OK button to confirm your choice.
- 5 Move the OK button UP to select 'Programme Index' then move RIGHT to enter the channel table.
- 6 Move the OK button UP or DOWN to select the channel you wish to view then press the OK button. The channel you selected appears on screen.

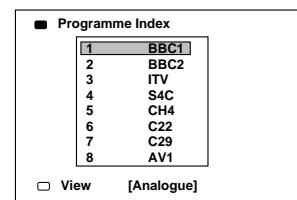

Overview of the TV set buttons

You must press the control button to activate and illuminate the control panel before you can use the other buttons on the top of the TV set.

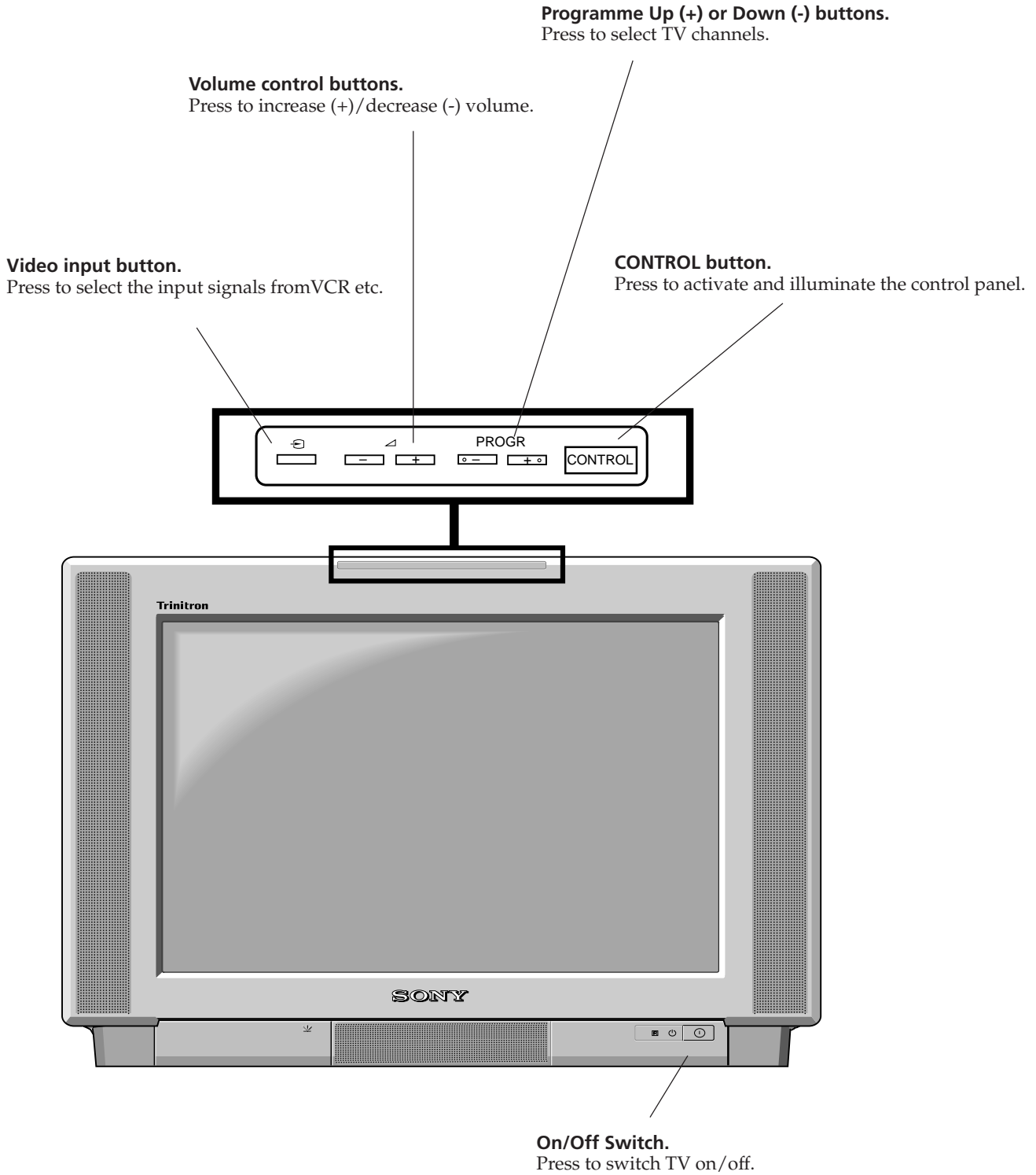

Overview of the remote control buttons

VCR on/off button

Press to temporarily switch off VCR (if Sony VCR connected). Press again to switch on VCR.

To mute sound

Press to mute TV sound. Press again to restore the sound.

To return to TV mode

Press to return to the normal operation from teletext mode or standby mode.

These buttons have no function.

To select teletext

Press to select Teletext mode.

To select EPG

Press to display the Electronic Programme Guide. Press again to remove display.

To freeze the picture

Press to freeze the picture. Press again to cancel freeze.

To select channels

Press numbered buttons to select channels.

For double-digit programme numbers, e.g. 23, press **-/--** first, then the buttons 2 and 3. If you enter an incorrect first digit, this should be corrected by entering another digit (0 - 9) and then selecting **-/--** button again to enter the programme number of your choice.

To display sound menu

Press to change the sound settings. Press again to remove the display.

To display picture menu

Press to change the picture settings. Press again to remove the display.

To adjust TV volume

Press to adjust the volume of the TV.

To temporarily switch off TV

Press to temporarily switch off TV. Press again to switch on TV from standby mode. **NOTE:** After 15 -30 minutes without a TV signal and without any button being pressed, the TV switches automatically into standby mode.

To reveal channel information

Press to reveal information on the channel you are currently watching. Move the OK button on the remote control **RIGHT** if you wish to change the audio language then press the OK button to confirm. Press the **+** button again to remove the display.

To select input signal or freeze teletext

Press to select inputs from the TV sockets (see Using Optional Equipment section). In teletext mode, press to freeze the displayed page. Press once again to cancel.

To return to previous channel

Press to return to the previous channel you were watching. **Note:** This can be done only after watching the present channel for 5 seconds.

To change screen format

Press to change the size of the screen.

This button can be used in Teletext mode only. Please see Teletext section of manual for details.

To select menu items

Use this OK button to select options available in the menu system of the TV.

To select channels

Press to select channels.

To display the menu

Press if you wish to use the TV menu system. Press again to remove the menu from the TV screen.

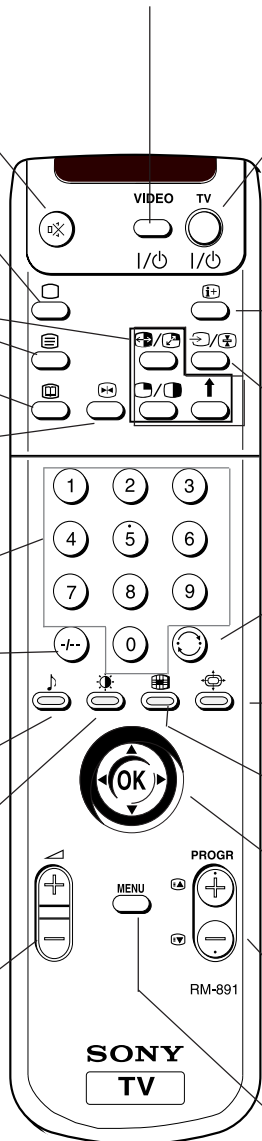

To control other Sony equipment

With this selector you can control other Sony equipment. Open the remote control lid and set the selector according to the type of equipment you want to control then use the buttons on the remote control to operate the equipment:

- VTR1 : Sony Beta VCR
- VTR2 : Sony 8mm VCR
- VTR3 : Sony VHS VCR
- VTR4 : Sony Digital VCR
- MDP : Sony Multi Disc Player

To reset to factory-set levels

Open the remote control lid and press to return picture and sound settings to factory-set levels.

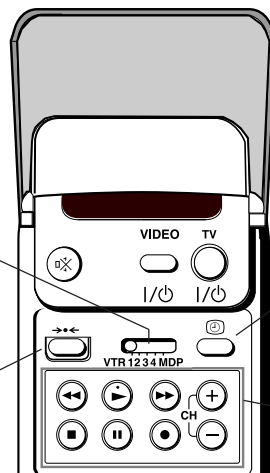

To display the time

Open the remote control lid and press to display the time on screen.

To operate video equipment

Open the remote control lid and press these buttons to operate your video equipment (please refer to your VCR manual).

Adjusting the picture

Although the picture is adjusted at the factory, you can modify it to suit your own taste.

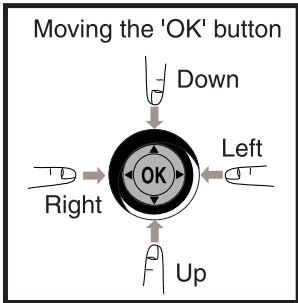

- 1 Press the MENU button on the remote control to display the menu on the TV screen.
- 2 Move the OK button on the remote control DOWN to select the symbol on the menu screen then move RIGHT to enter the 'PICTURE CONTROL' menu on the TV screen.
- 3 Move the OK button UP or DOWN to select the item on the screen you wish to adjust. For a description of the menu items and their effects, see the following table.
- 4 Move the OK button RIGHT to highlight the settings.
- 5 Adjust the setting by moving the OK button UP, DOWN, LEFT or RIGHT.
- 6 As soon as you have adjusted the item, press the OK button to store the new setting.
- 7 Repeat steps 3-6 to adjust the other items.
- 8 Press the MENU button to remove the display from the TV screen.

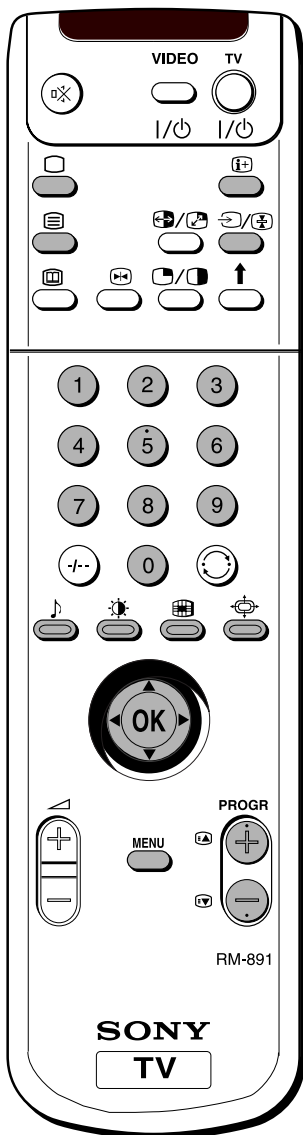
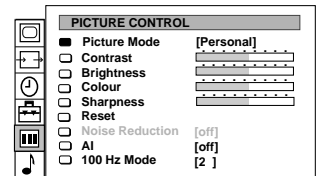
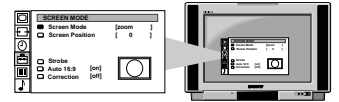

Item	Operation/Effect
Picture Mode	▼ Personal (for individual settings) Movie (for films) ▲ Live (for live broadcasts)
Contrast	◀ Less ▶ More
Brightness*	◀ Darker ▶ Brighter
Colour*	◀ Less ▶ More
Hue**	◀ Greenish ▶ Reddish
Sharpness*	◀ Softer ▶ Sharper
Reset	Resets picture to factory preset levels
AI (Artificial Intelligence)	▼ Off: normal ▲ On: automatic optimization of contrast level according to the TV signal.
Noise Reduction***	▼ Off: normal ▲ On: reduces picture noise in case of a weak broadcast signal.
100 Hz Mode	▼ 1: normal ▲ 2: Line Flicker Reduction off.

* Only if you select 'Personal' in 'Picture Mode'.

** Available for NTSC colour system only.

*** Available when viewing analogue channels only.

Changing Picture and Sound Modes Quickly

You can quickly change the Picture Mode or the Equalizer Mode without entering the 'PICTURE CONTROL' or the 'SOUND CONTROL' menu screens.

- 1 Press the symbol on the remote control for picture modes or the symbol for equalizer modes.
- 2 Move the OK button on the remote control UP or DOWN to select the desired mode.
- 3 Press or again to remove the display from the TV screen.

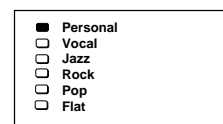
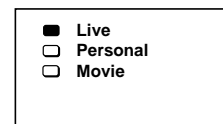

Adjusting the sound

Although the sound is adjusted at the factory, you can modify it to suit your own taste.

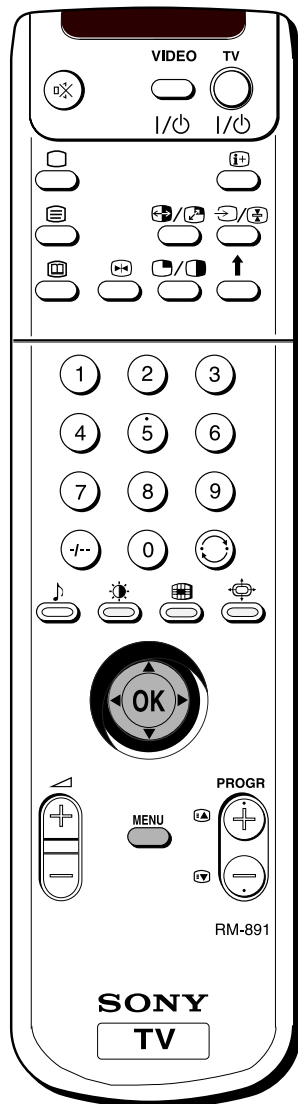
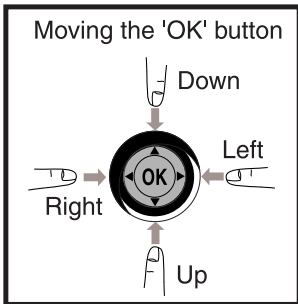

- 1 Press the MENU button on the remote control to display the menu on the TV screen.
- 2 Move the OK button on the remote control DOWN to select the symbol on the menu screen then move RIGHT to enter the 'SOUND CONTROL' menu on the TV screen.
- 3 Move the OK button UP or DOWN to select the item on the screen you wish to adjust. For a description of the menu items and their effects, see the following table.
- 4 Move the OK button RIGHT to highlight the settings.
- 5 Adjust the setting by moving the OK button UP, DOWN, LEFT or RIGHT.
- 6 As soon as you have adjusted the item, press the OK button to store the new setting.
- 7 Repeat steps 3 to 6 to adjust the other items.
- 8 Press the MENU button to remove the display from the TV screen.

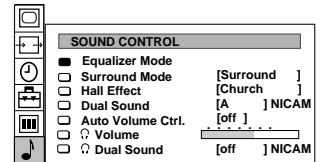
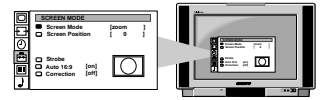

Item	Effect/Operation
Equalizer Mode	<ul style="list-style-type: none"> ▲ Personal Vocal Jazz Rock Pop ▼ Flat (fixed setting, cannot be adjusted)
Equalizer adjustment	You can adjust the mode selected in Equalizer mode by cutting and boosting the 5 selected frequency bands. Only the changes made in Personal can be stored, the others return to factory setting. Select the desired bar by moving the OK button LEFT or RIGHT then make the appropriate adjustment by moving the OK button UP or DOWN. Press the OK button to store.
Surround Mode	<ul style="list-style-type: none"> ▲ Off Pro Logic ▼ Hall
*Hall Effect	<ul style="list-style-type: none"> ▲ Stadium Disco Church ▼ Hall
Dual Sound	<ul style="list-style-type: none"> • For a bilingual broadcast: A for channel 1▲ ▼B for channel 2 • For a stereo broadcast: Stereo▲ ▼Mono
**Auto Volume Control	<ul style="list-style-type: none"> ▼ On: volume level of the channels will stay the same independent of the broadcast signal (e.g. in case of advertisements) ▲ Off: volume level changes according to the broadcast signal

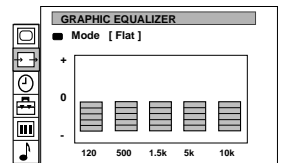

Headphones
 ⏪ Volume ⏩ More
 ⏪ Dual Sound ⏩
 • For a bilingual broadcast:
 A for channel 1▲ ▼B for channel 2

Note: To set headphones to Stereo or Mono select the speaker "Dual Sound" in the display and set to Stereo or Mono (the headphones will be set the same as the speakers). For bilingual broadcasts, if the speakers are set to Mono then the headphones will also be Mono.

* Only if "HallC is selected in Surround Mode.
 ** Only if Surround Mode is switched to "off"

Setting up Dolby ProLogic

Before listening to Dolby Surround sound, you can adapt the Dolby features to suit your own taste. It is normal to set up the levels and modes of the speakers only when installing the TV and the speakers or when changing the position of the speakers.

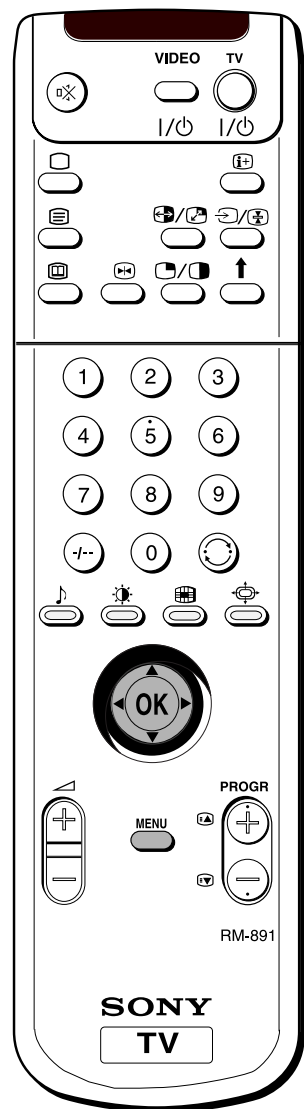
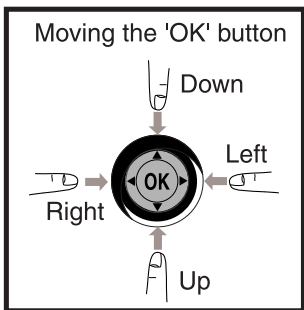

- 1 Press the MENU button on the remote control to display the menu on the TV screen.
- 2 Move the OK button on the remote control DOWN to select the  symbol on the TV screen then move to RIGHT to enter the 'PRESET' menu.
- 3 Move the OK button DOWN to select 'Installation' then move the OK button RIGHT to enter the 'INSTALLATION' menu.
- 4 Move the OK button DOWN to select 'Dolby ProLogic Setup' then move RIGHT to enter the 'DOLBY PROLOGIC SETUP' menu.
- 5 Move the OK button UP or DOWN to select 'Level Settings' then move RIGHT to confirm.
- 6 Select Left (left speaker), Centre (centre speaker), Right (right speaker) or Surround (surround speakers) by moving the OK button UP or DOWN then move the OK button RIGHT to store.
- 7 Adjust the level by moving the OK button RIGHT or LEFT.
- 8 After you have adjusted the level, press the OK button to store the new level.
- 9 Repeat steps 6 to 8 if you wish to adjust the sound levels of the other speakers (from your sitting position the sound output from all speakers should balance).
- 10 Move the OK button LEFT.
- 11 Select 'Speaker mode' by moving the OK button DOWN then move the OK button RIGHT to enter.
- 12 Push the OK button repeatedly DOWN to select:
 - Normal - all speakers are activated
 - 3 Wide - surround speakers are not used, centre speaker carries full frequency response
 - 3 Normal - surround speakers are not used
 - Wide - wider bandwidth for centre speaker
 - Phantom - centre speaker is not used

Press the OK button to store your choice.
- 13 Select 'Delay Time' by moving the OK button DOWN then move RIGHT to enter. Adjust the delay time of the surround speakers by moving the OK button UP or DOWN (e.g 20 ms for standard rooms, 30 ms for small rooms) 15 ms → 20 ms → 25 ms → 30 ms

Press the OK button to store your choice.
- 14 Select 'Auto Surround' by moving the OK button DOWN then move RIGHT to enter. Move the OK button DOWN to select:
 - On - When receiving a Dolby Surround encoded programme, the TV switches automatically to Dolby Surround sound (depending on availability of service by broadcaster).
 - Off - normal

Press the OK button to store your choice.
- 15 Press the MENU button on the remote control to remove the menu from the TV screen.

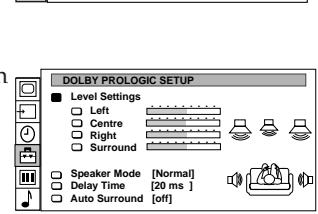
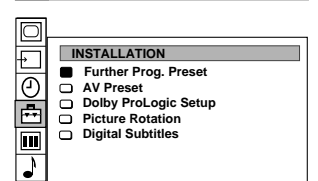
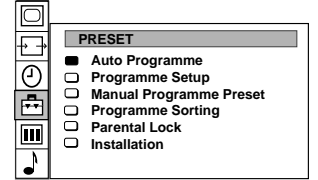
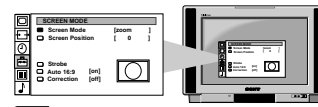

Changing the screen mode

Using this Screen Mode feature you can change the aspect ratio of the screen or reproduce the main picture image by image (Strobe function).

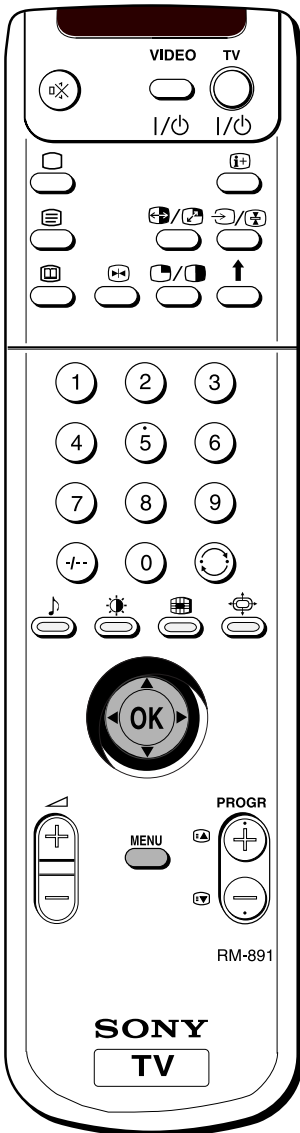
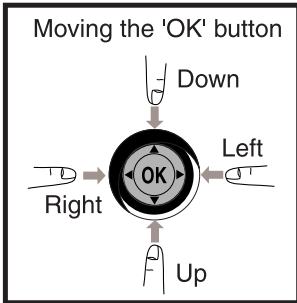

- 1 Press the MENU button on the remote control to display the menu on the TV screen.
- 2 Move the OK button on the remote control RIGHT to select 'Screen Mode', then move RIGHT again to select the brackets. Move the OK button repeatedly UP or DOWN to select one of the following modes:

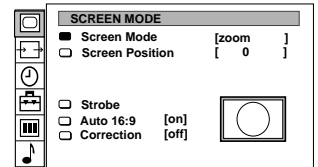
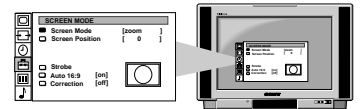

- smart - imitation of wide screen effect (16:9) for 4:3 broadcasts.
 - wide - for 16:9 broadcasts
 - zoom - imitation of wide screen effect (16:9) for movies broadcast in cinemascopic format.
- In zoom mode and 14:9 mode you can use 'Screen position' to move the screen up- or downwards in order to see the cut-off parts (e.g. to read subtitles). Move the OK button DOWN to select 'Screen Position' then move RIGHT to enter. Move the OK button UP or DOWN to adjust the screen position over a range of -4 to +4 if in 14:9 mode or -10 to +10 if in Zoom mode. Press the OK button to store.
- 14:9 - compromise between 4:3 and 16:9 format - for conventional 14:9 picture.
 - 4:3 - conventional 4:3 picture

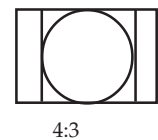
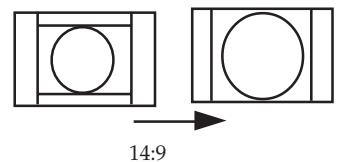
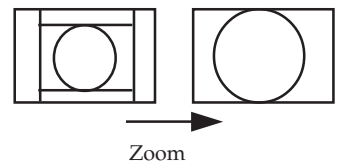
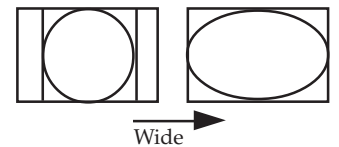
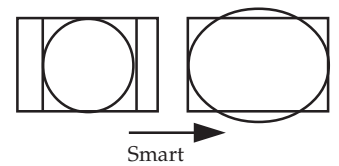

- 3 Press the OK button to store the selection.
- 4 Strobe Mode
Move the OK button DOWN to select 'Strobe'. Press the OK button to confirm. The TV picture is now displayed image by image, creating a slow motion effect. Move the OK button UP or DOWN to select the speed of the motion. Press the OK button to cancel the strobe mode.
- 5 Auto 16:9
Move the OK button DOWN to select 'Auto 16:9' then move RIGHT to enter. Move the OK button DOWN to select 'On' if you wish the TV set to switch automatically to wide format if a 16:9 broadcast is detected or 'Off' for normal mode. Press the OK button to store.
- 6 Correction (only for Auto 16:9)
In case of automatic format detection there are two possibilities for 4:3/14:9 signals: Set Correction to 'on' if you wish Smart mode to appear on the screen or set it to 'off' if you prefer 4:3/14:9 mode. Move the OK button DOWN to select 'Correction' then move RIGHT to enter. Move the OK button DOWN to select 'On' or 'Off'. Press OK button to store.
- 7 Press the MENU button to remove the menu from the TV screen.

Exchanging programme positions

After tuning you may wish to change the channel order on the TV. You may wish for example to exchange the channel on programme number 8 with the channel on programme number 10.

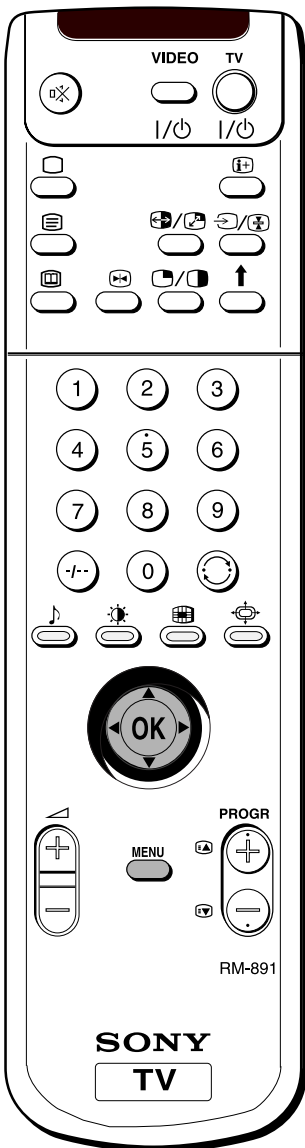
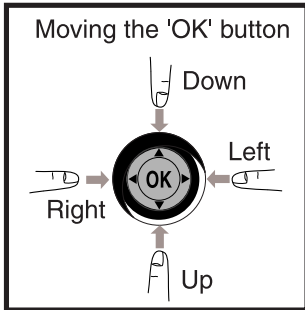



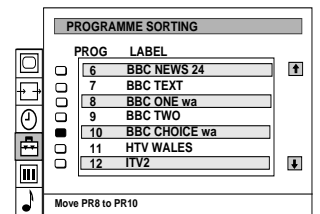
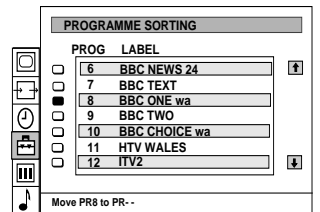
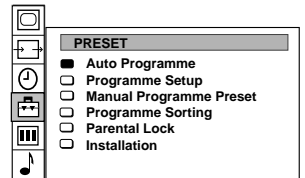
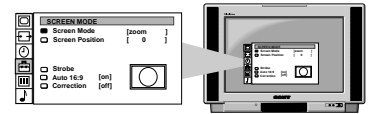

- 1 Press the MENU button on the remote control to display the menu on the TV screen.
- 2 Move the OK button on the remote control DOWN to select the symbol  on the menu screen then move RIGHT to enter the 'PRESET' menu.
- 3 Move the OK button DOWN to select 'Programme Sorting' then move RIGHT to enter the 'PROGRAMME SORTING' menu.
- 4 Move the OK button UP or DOWN to select the programme position of the channel you want to move (e.g. PROG 8). Press the OK button to enter.
- 5 Move the OK button UP or DOWN to select the new programme position for your chosen channel then press the OK button to exchange the channels.
- 6 Repeat steps 4 and 5 if you wish to change the order of the other channels on your TV, then press the MENU button to remove the menu from the TV screen.
- 7 Press the PROGR+/- button to view your selected channels on their new programme numbers.

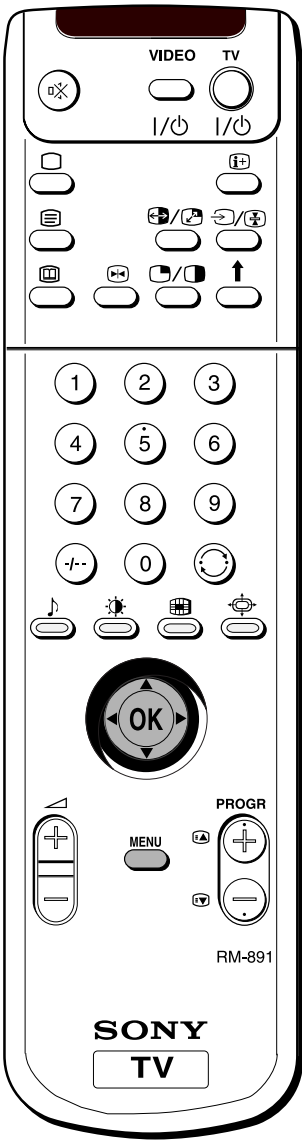
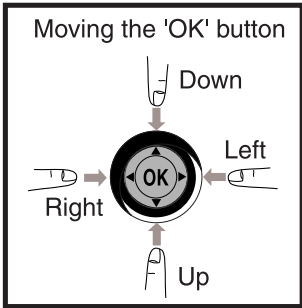

Using the parental lock

This function enables you to prevent children watching undesirable broadcasts.



- 1 Press the MENU button on the remote control to display the menu on the TV screen.
- 2 Move the OK button on the remote control DOWN to select the symbol  on the menu screen then move RIGHT to enter the 'PRESET' menu.
- 3 Move the OK button DOWN to select 'Parental Lock' then move RIGHT to enter the 'PARENTAL LOCK' menu.
- 4 Move the OK button DOWN to select the channel you want to block. Press the OK button to confirm. The symbol  appears before the programme position to indicate that this channel is now blocked. To unblock the channel, press the OK button again. The symbol  disappears.
- 5 Repeat step 4 to block other channels.
- 6 Press the MENU button to remove the menu from the TV screen.

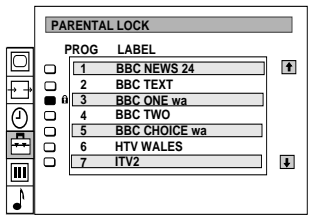
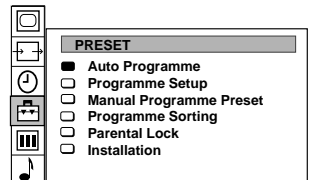
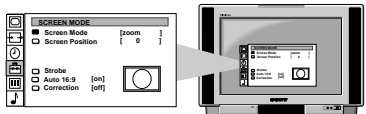

Using Further Programme Preset

With this feature you can

- a) individually adjust and store the volume level of each channel (Volume Offset).
- b) preset the AV output for the programme positions of channels with scrambled signals (e.g. from a Pay TV decoder). In this way a connected VCR records the unscrambled signal.

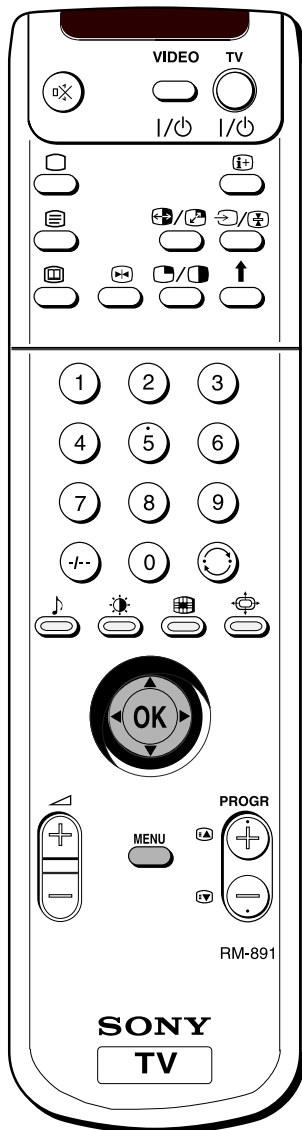
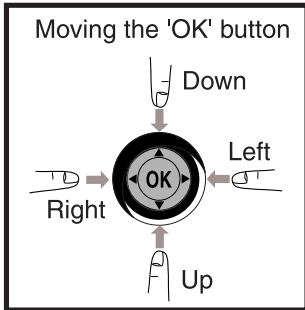

1 Press the MENU button on the remote control to display the menu on the TV screen.

2 Move the OK button on the remote control DOWN to select the symbol  on the menu screen then move RIGHT to enter the 'PRESET' menu.

3 Move the OK button DOWN to select 'Installation' then move RIGHT to enter the 'INSTALLATION' menu.

4 Move the OK button DOWN to select 'Further Prog. Preset' then move RIGHT to enter the 'FURTHER PROGRAMME PRESET' menu.

5 Move the OK button UP or DOWN to select the programme position you want then move repeatedly RIGHT to select:
a) VOL (Volume Offset), b) AFT, c) DECODER. The selected item changes colour.

6a) VOL

Move the OK button UP or DOWN to adjust the volume for the selected programme position within a range of -7 to +7. Press the OK button to confirm. Repeat steps 5 and 6 to set the volume level for other programme positions.

6b) AFT

In case of picture or sound distortions, use this AFT (fine tuning) function to improve the overall quality. Move the OK button UP or DOWN to adjust the fine tuning for the selected programme position within a range of -15 to +15. The factory setting for AFT is "on". Press the OK button to confirm. Repeat steps 5 and 6 to set the AFT level for other programme positions.

6c) DECODER

Move the OK button repeatedly DOWN to select AV1 or AV2 for the programme position and press the OK button to confirm. You can now attach a decoder to the AV1 or the AV2 socket on the back of the TV and the picture from that decoder will appear on this programme number. Repeat steps 5 and 6b to preset the AV output for other programme positions.

7 Press the MENU button to remove the menu from the TV screen.

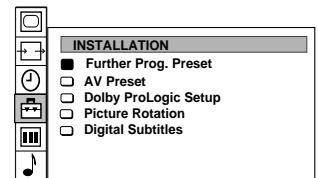
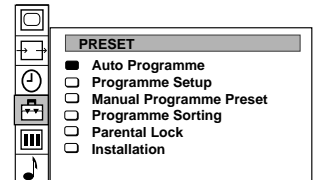
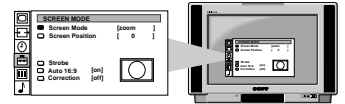



PROG	VOL	AFT	DECODER
1	0	on	off
2	-1	on	AV2
3	-3	on	off
4	0	on	off
5	0	on	off
6	0	on	off
7	0	on	off

*the AFT and DECODER columns appear only when viewing analogue channels.

Adjusting the picture rotation

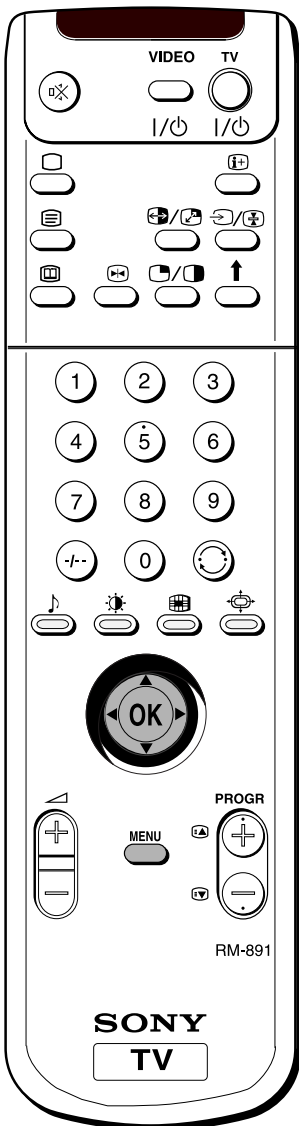
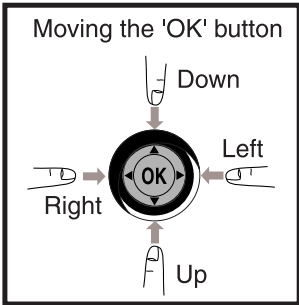
If, due to the earth's magnetic field, the picture slants, you can use this function to readjust the picture.



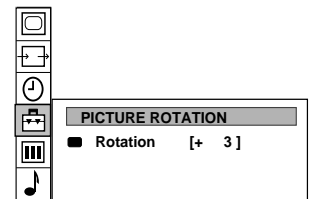
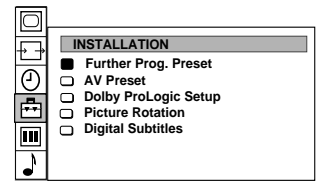
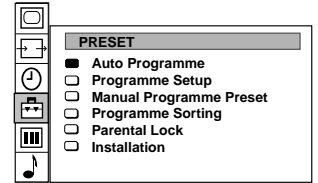
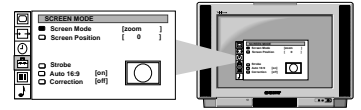

- 1 Press the MENU button on the remote control to display the menu on the TV screen.
- 2 Move the OK button on the remote control DOWN to select the symbol  on the menu screen then move to RIGHT to enter the 'PRESET' menu.
- 3 Move the OK button DOWN to select 'Installation' then move RIGHT to enter the 'INSTALLATION' menu.
- 4 Move the OK button DOWN to select 'Picture Rotation' then move RIGHT to enter the 'PICTURE ROTATION' menu.
- 5 Move the OK button RIGHT then move UP or DOWN to adjust the picture rotation. The adjusting range is - 4 to +4. Press the OK button to store the new range.
- 6 Press the MENU button to remove the menu from the TV screen.

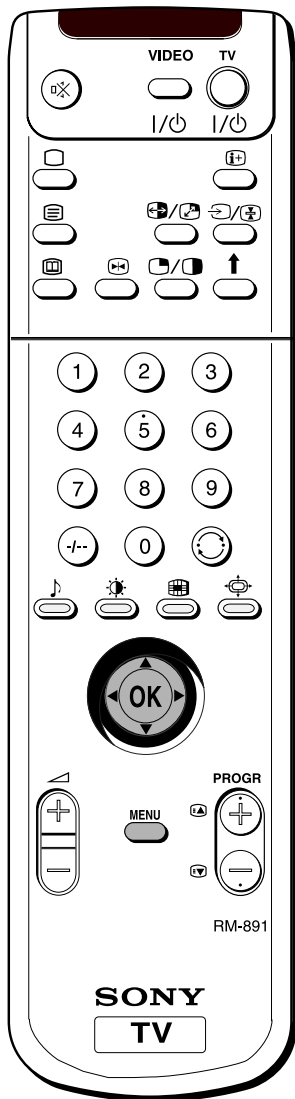
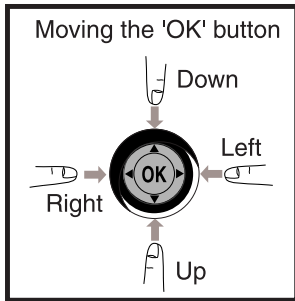

Displaying subtitles for digital channels

With this feature you can view subtitles on the TV screen when watching digital channels. When watching analogue channels you can view subtitles via the teletext menu screen (see the Teletext section of this instruction manual).



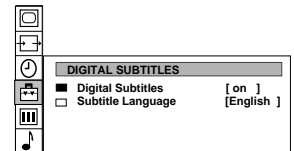
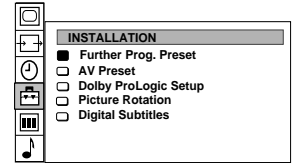
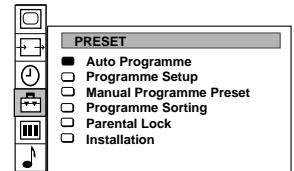
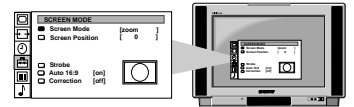

- 1 Press the MENU button on the remote control to display the menu on the TV screen.
- 2 Move the OK button on the remote control DOWN to select the symbol  on the menu screen then move RIGHT to enter the 'PRESET' menu.
- 3 Move the OK button DOWN to select 'Installation' then move RIGHT to enter the 'INSTALLATION' menu.
- 4 Move the OK button DOWN to select 'Digital Subtitles' then move RIGHT to enter the 'DIGITAL SUBTITLES' menu.
- 5 Move the OK button RIGHT to select 'Digital Subtitles' then move DOWN to switch on/off digital subtitles.
- 6 Press the OK button to store.
- 7 If you have switched on the subtitles and wish to change the subtitle language, move the OK button DOWN to select 'Subtitle Language' then move RIGHT to highlight the language options.
- 8 Move the OK button repeatedly DOWN to select your chosen language then press the OK button to confirm your choice.
- 9 Press the MENU button to remove the menu from the TV screen.



Using the sleep timer

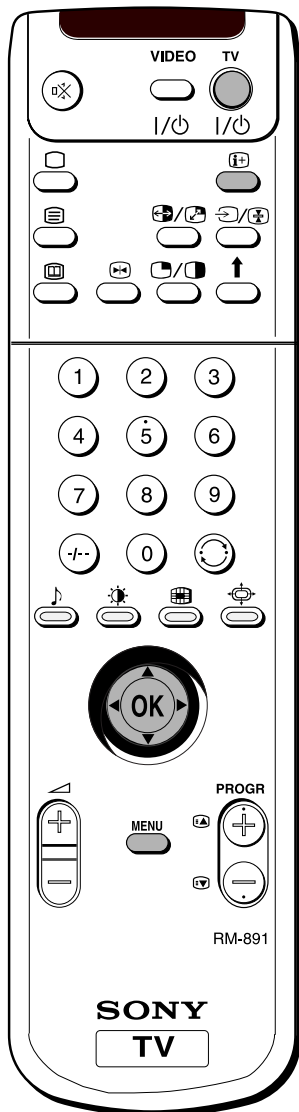
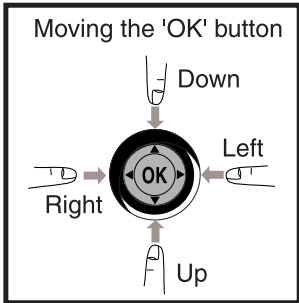

The TV can be set to switch automatically to standby mode after a length of time chosen by you. You may set the time in 15 minute steps up to 4 hours.

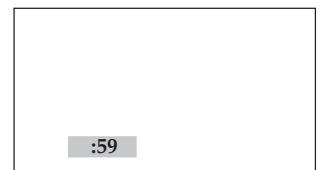
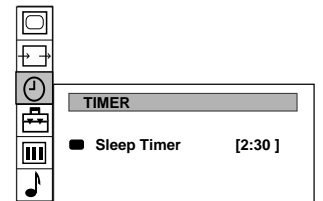
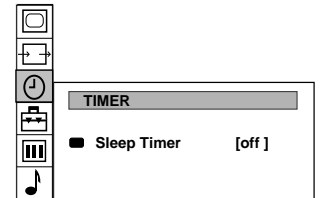
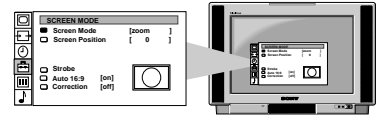

- 1 Press the MENU button on the remote control to display the menu on the TV screen.
- 2 Move the OK button on the remote control DOWN to select the  symbol on the TV screen, then move RIGHT twice.
- 3 Move the OK button UP or DOWN repeatedly until the required amount of time delay appears on the screen.
- 4 Once the time delay has been selected, press the OK button to enter.
- 5 Press the MENU button to remove the menu from the TV screen.
One minute before standby, the display shown appears on the screen.





Notes:

- When watching TV, press the  button to display time remaining.
- To return to normal operation from standby mode, press the  button.

Manually tuning the TV

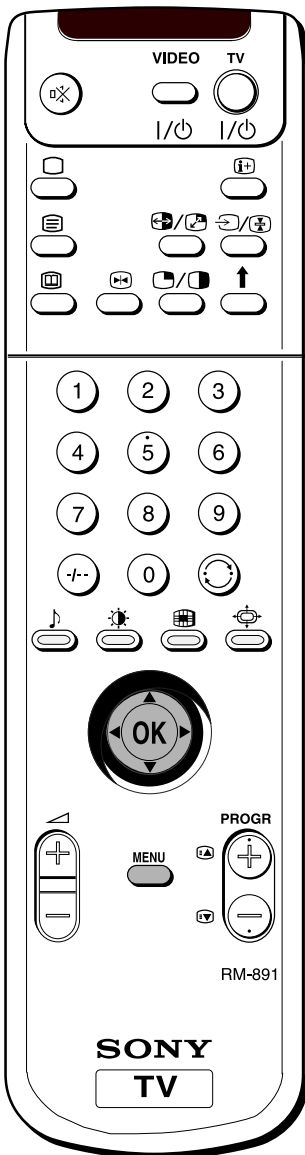
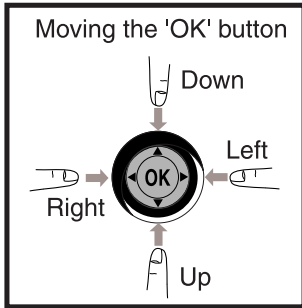
You have already tuned the TV to receive all available channels using the 'Automatically Tuning the TV' procedure at the start of this manual. You can however carry out this operation manually using the following instructions.



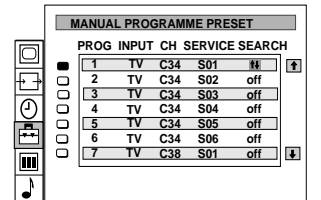
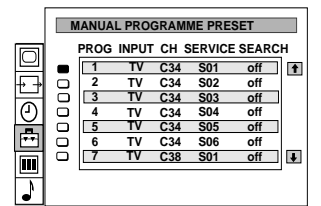
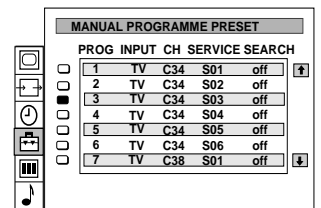
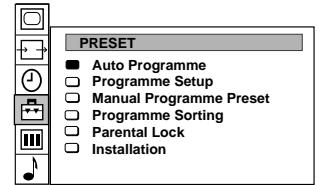
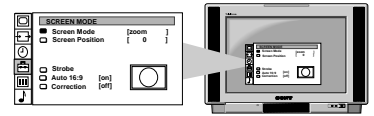

- 1 Press the MENU button on the remote control to display the menu on the TV screen.
- 2 Move the OK button on the remote control DOWN to select the  symbol on the menu screen then move RIGHT to enter the 'PRESET' menu.
- 3 Move the OK button DOWN to select 'Manual Programme Preset' then move RIGHT to enter the 'MANUAL PROGRAMME PRESET' menu.
- 4 Move the OK button UP or DOWN to select a programme number for your channel (eg PROGR 1 for BBC1) then move RIGHT to enter.
- 5 Move the OK button repeatedly RIGHT until  appears in the SEARCH column.
- 6 Move the OK button UP or DOWN to search for a channel.
- 7 If you do not wish to store this channel on the programme number you selected, move the OK button UP or DOWN to continue searching for the desired channel.
- 8 If this is the channel you wish to store, press the OK button.
- 9 Repeat steps 4 to 8 if you wish to store more channels then press the MENU button to remove the menu from the TV screen.

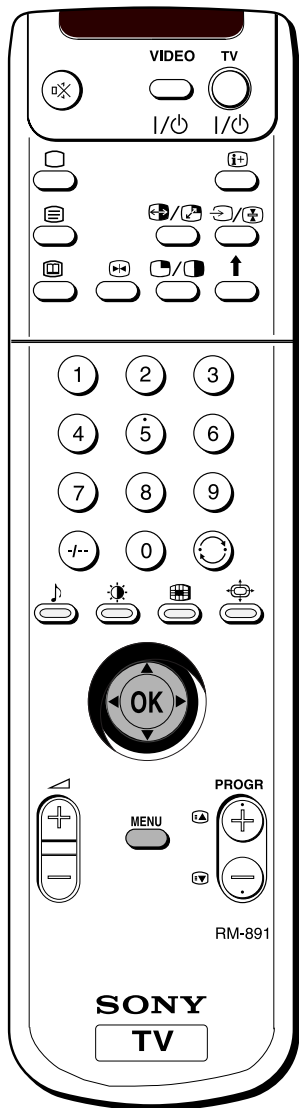
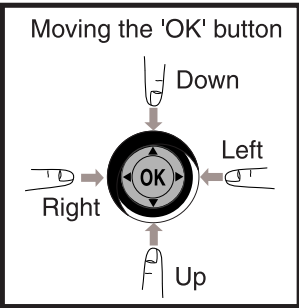

Skipping programme positions

This function enables you to skip unused programme positions when selecting them with the **PROGR +/-** buttons. However, by using the number buttons you can still select the skipped programme position.



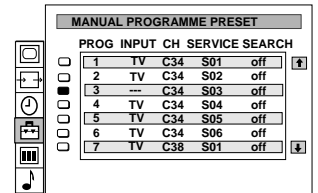
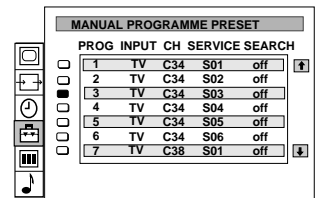
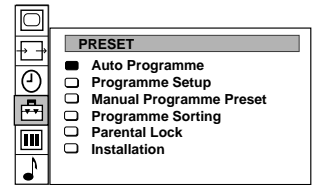
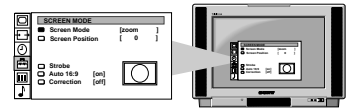

- 1 Press the **MENU** button on the remote control to display the menu on the TV screen.
- 2 Move the **OK** button on the remote control **DOWN** to select the symbol  on the menu screen then move **RIGHT** to enter the 'PRESET' menu.
- 3 Move the **OK** button **DOWN** to select 'Manual Programme Preset' then move **RIGHT** to enter the 'MANUAL PROGRAMME PRESET' menu.
- 4 Move the **OK** button **UP** or **DOWN** to select the programme position you want to skip then move **RIGHT** to enter the 'INPUT' column.
- 5 Move the **OK** button **DOWN** to select '---' then press the **OK** button to store.
- 6 Repeat steps 4 and 5 to skip other programme positions.
- 7 Press the **MENU** button to remove the menu from the TV screen.

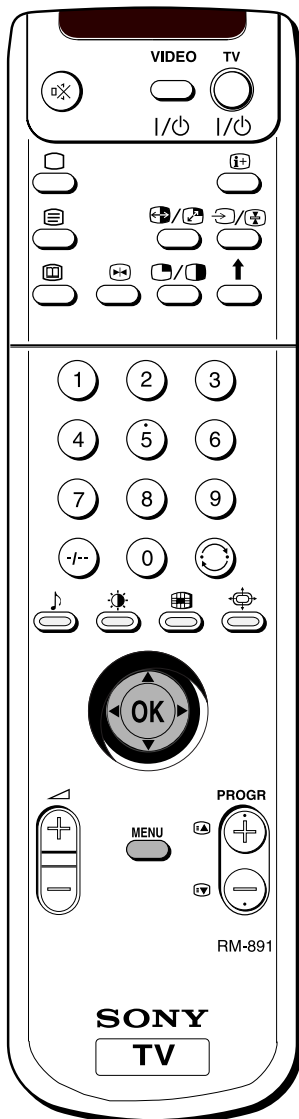
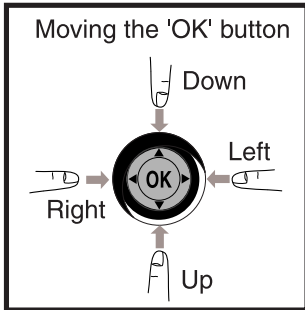

Adjusting the TV picture for an RGB source

After connecting an RGB source such as a playstation to the TV, you may need to adjust your TV picture.



- 1 Press the MENU button on your remote control to display the menu on the TV screen.
- 2 Move the OK button DOWN to select the symbol  on the menu screen then move RIGHT to enter the 'PRESET' menu.
- 3 Move the OK button DOWN to select 'Installation' on the TV screen then move RIGHT to enter the 'INSTALLATION' menu.
- 4 Move the OK button DOWN to select 'RGB SetUp' on the TV screen then move RIGHT to enter the 'RGB SETUP' menu.
- 5 Move the OK button RIGHT to select 'Centre' adjustment on the screen then move UP or DOWN to adjust the centre of the picture vertically over the range -15 to +15 and LEFT or RIGHT to adjust the centre of the picture horizontally over the range -10 to +10.
- 6 Press the OK button to confirm the range.
- 7 Move the OK button DOWN then RIGHT to select 'Size' adjustment on the screen, then move UP or DOWN to adjust the vertical size of the picture over the range -15 to +15 and LEFT or RIGHT to adjust the horizontal size of the picture over the range -10 to +10.
- 8 Press the OK button to confirm the new size.
- 9 Press the MENU button to remove the menu from the TV screen.

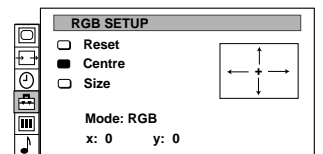
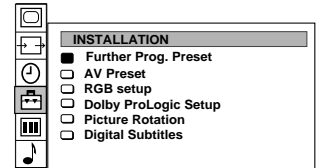
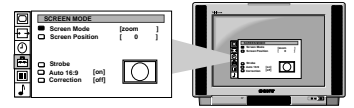

Viewing Standard Teletext

Standard Teletext is an information service transmitted by broadcasters which can be viewed on most of your traditional analogue channels.

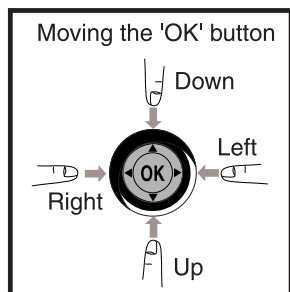

Selecting Teletext

- 1 When viewing analogue channels, press a number button on the remote control to select the channel which carries the teletext service you wish to receive.
- 2 Press the button on the remote control to switch on teletext. Press the button again to superimpose teletext on to the TV screen.
- 3 Input three digits for the page number using the numbered buttons on the control. If you make a mistake, type in any three digits then re-enter the correct page number.

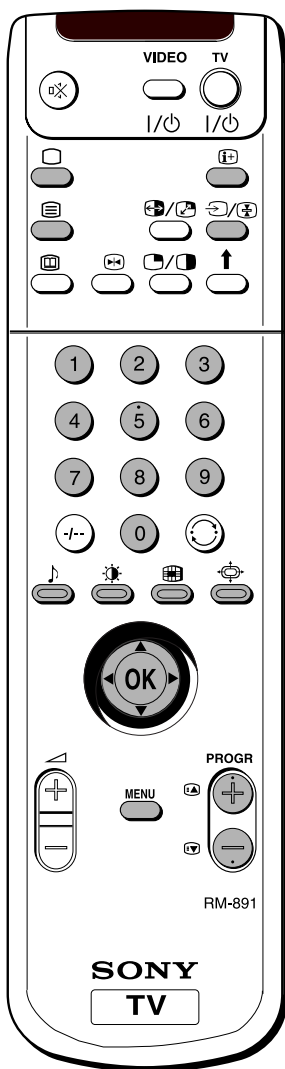
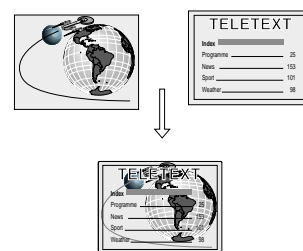
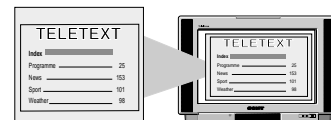

Using Other Teletext Functions

Page Catching

Input a teletext page number. Press the OK button. 'Page Catching' is displayed at the top of the page. Move the OK button UP or DOWN to select the page number you require. Press the OK button. The requested page is displayed after some seconds.

To Move to Next or Preceding Page

Press or on the control to select the previous or next page.

To Freeze a Teletext Page

Press on the control to freeze the page. Press the button to cancel the freeze.

Revealing concealed information (eg: answers to a quiz).

Press to reveal information. Press again to conceal the information.

Using colour buttons to access pages

When the colour coded menu appears at the bottom of a page, press the colour button (green, red, yellow or blue) on the control to access the corresponding page.

Displaying TOP-Text (when available)

With TOP-Text you can access pages easily by selecting blocks or groups of pages. The block is a category (for example Sports) which includes the groups (for example Football). When TOP-Text is broadcast, a colour coded menu appears at the bottom of the screen. The colours of this menu correspond to the red, green, yellow and blue buttons on the remote control. Press these coloured buttons to display the desired pages.

- 1 Press the button to display teletext.
- 2 Press the coloured buttons to search the page you desire:
 Red: to go back to the previous page
 Green: to proceed to the next page
 Yellow: to proceed to the first page of the next group
 Blue: to proceed to the first page of the next block
- 3 Press the button to return to the normal screen.

Viewing Standard Teletext

When viewing analogue channels, select further standard teletext functions as follows:

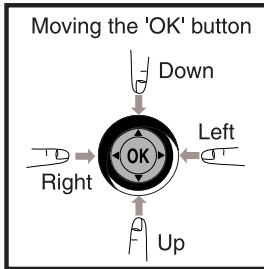

Using the Teletext Menu

- 1 With teletext on the TV screen, press the MENU button on the remote control to display the teletext menu.
- 2 Move the OK button on the remote control DOWN to select the teletext function you want then move RIGHT to enter your choice:

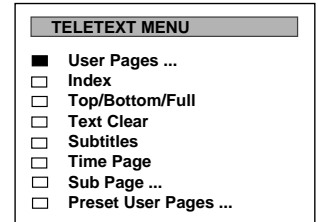

Preset User Pages...

For quick access to the pages you frequently use, you can store your favourite teletext pages.

- 1 Push to ▼ to select the bank (from A to E) in which you want to store the pages then push to ► to confirm.
- 2 Push to ▼ to select the three digits of your 6 favourite pages in columns P1 -P6. Push to ► after selecting each digit. Press the OK button to confirm your selections.
- 3 Push to ▼ to select 'Allocate Bank' then push to ► to confirm.
- 4 Push to ▼ to select the programme position which is carrying the teletext service containing your favourite pages, then push to ► to confirm.
- 5 Push to ▼ to select the bank chosen in step 1 then press the OK button to confirm.
- 6 Repeat steps 1 to 5 if you wish to store pages in the other our available banks.

PRESET USER PAGES						
BANK	P1	P2	P3	P4	P5	P6
■ A	232	102	154	---	---	160
□ B	151	100	252	---	380	---
□ C	---	---	---	---	---	---
□ D	---	---	---	---	---	---
□ E	---	120	---	---	---	---
Allocate Bank						
□	Prog	Label	Bank	Prog	Label	Bank
□ 1	BBC1	A	5	S4C	A	
□ 2	BBC2	B	6	---	---	
□ 3	ITV	-	7	---	---	
□ 4	CH4	-	8	---	---	

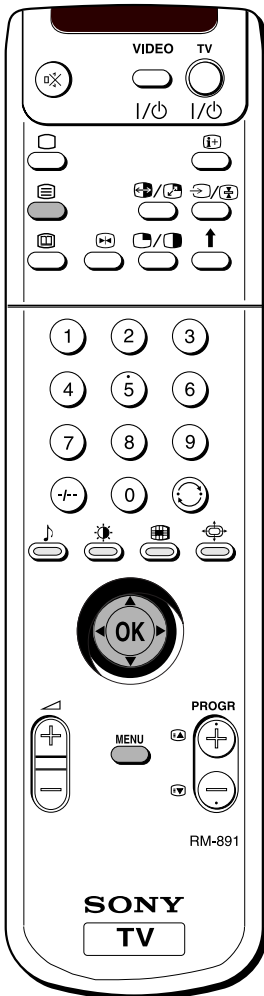

User Pages...

- 7 Push to ◀ twice to display the Teletext menu screen.
- 8 Push to ▼ to select User Pages then push to ► to confirm.
- 9 Push to ▼ to select a favourite page then press the OK button to display the page.

USER PAGES		BANK A
■	Page 102	
□	Page 200	
□	Page 354	
□	Page 100	
□	Page 380	
□	Page 124	

Index

The index gives you an overview of the teletext contents.

Top/Bottom/Full

For easier reading, you can enlarge the teletext page. Push the OK button to ▲ to enlarge the upper half, push to ▼ to enlarge the lower half. Press the OK button to resume the normal display.

Text Clear

After selecting this function, you can watch a TV programme while waiting for a requested teletext page to be captured. When the page is available, it will be displayed.

Subtitles

Check with your teletext service for information about subtitled TV programmes. After selecting the function the subtitles are displayed. Press the function again to remove the subtitles.

Time Page

Check with your teletext service about the availability of time coded pages. If available, you can call up a page at a certain time.

- 1 With the Time Page menu on the TV screen, push to ► then push to ▼ to select 'on'. Push to ► to confirm.
- 2 Push to ▼ to enter the three digits of the page you want (eg 301) and the four digits of the desired time (eg 18:54). Push to ► after each digit. Press the OK button to confirm. At the requested time, the page you selected is displayed.

TIME PAGE			
■	off	---	---:--

Subpage



Using this function you can select the subpages, if available, of a particular teletext page. After selecting the function push to ► to access the various subpages. Select the function again to cancel the request.

Viewing Digital Teletext

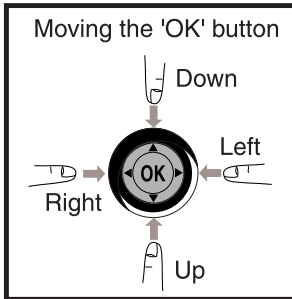
Most of the digital TV channels broadcast information via teletext. This digital service includes high quality text and graphics as well as advanced navigational options. Additionally this television set has access to a dedicated digital teletext channel.



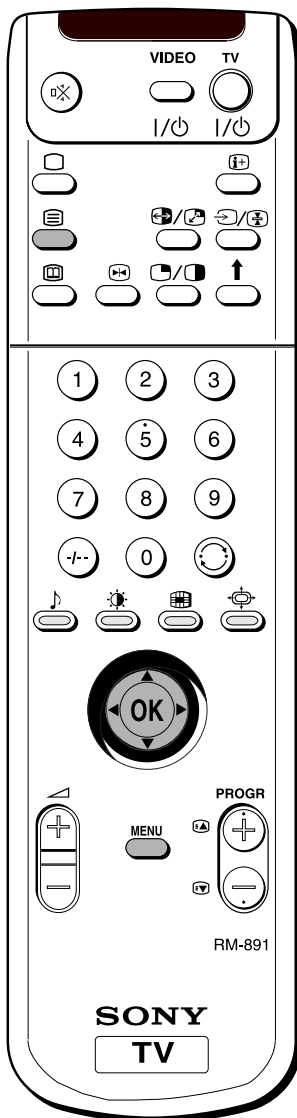

Selecting the dedicated digital teletext channel

- 1 To view the dedicated digital teletext service, press the numbered buttons on your remote control to select the relevant channel number. If you do not know the channel number, press the OK button to look for this channel in the channel table.
- 2 Once this teletext channel is displayed on screen move the OK button on the remote control UP, DOWN, LEFT or RIGHT to guide the on-screen cursor to the required area of the screen then press the OK button to display the chosen information.
- 3 Alternatively, you can use the number and colour buttons on your remote control to directly enter the number of the page you require and to display the various pages of text information.
- 4 If, when viewing the teletext pages, you are requested to select 'OK' or 'Cancel', press the OK button for 'OK' or the  button for 'Cancel'.
- 5 When you have finished viewing Teletext, press the  button and then select an alternative digital channel.





Selecting teletext from the other digital channels

Normal Teletext services may also be available on other digital channels. Sometimes this is indicated by a small symbol or text display on your TV screen, superimposed on the channel you are watching.

- 1 Press the OK button UP, DOWN, LEFT or RIGHT to select the symbol then press the OK button to display the chosen information.
- 2 Alternatively, you may be requested to use the number and colour buttons on your remote control to display the various pages of text information. If, when viewing the teletext pages, you are requested to select 'OK' or 'Cancel', press the OK button for 'OK' or the  button for 'Cancel'.
- 3 Once the text information is displayed on screen, use the UP, DOWN, LEFT, RIGHT arrows, the colour buttons and/or the number buttons to access the chosen information.
- 4 When you have finished viewing Teletext, press the  button and then select an alternative digital channel.

On other channels there may be no on-screen symbol, but you can see if there is a digital text service as follows:

- 1 When you are watching a digital TV channel, press the  button on your remote control to display any text service which may be available.
- 2 Press the number buttons to select the various pages of information available and/or the colour buttons for the functions shown on the screen.
- 3 When you have finished using the text service, press the  button to return to a normal TV picture.

Electronic Programme Guide (EPG)

The Electronic Programme Guide (EPG) is a guide which provides programme information for all digital channels supporting EPG.

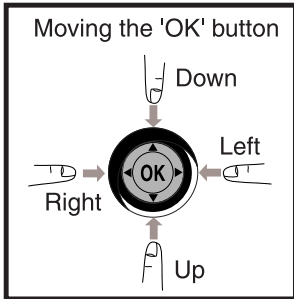

Displaying the EPG

- 1 Press the button on the remote control to display the programme guide on the TV screen. You may see the message 'EPC INFORMATION IS TEMPORARILY UNAVAILABLE' whilst waiting for the EPG to appear on screen.
- 2 Move the OK button on the remote control UP, DOWN, LEFT or RIGHT to move the on-screen cursor around the guide.
- 3 Press the button again to remove the programme guide from the TV screen.

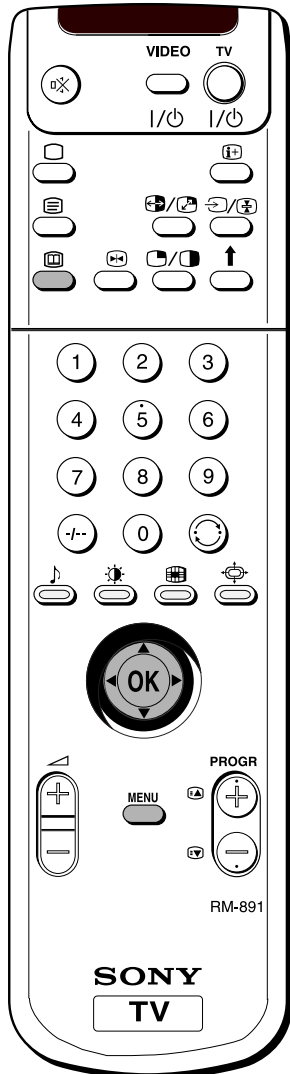

Viewing Information on the EPG

You can alter the type of information presented on the EPG by changing data in each of the EPG columns. You can for example display information for all sports programmes being shown tomorrow from 5.00pm onwards.

- 1 Press the button on the remote control to display the EPG on the TV screen.
- 2 Move the OK button on the remote control RIGHT or LEFT to highlight the 'date' column then move the OK button UP or DOWN to select your chosen date.
- 3 Move the OK button RIGHT or LEFT to highlight the 'time' column then move the OK button UP or DOWN to select your chosen time.
- 4 Move the OK button RIGHT or press the OK button. The EPG will display programme information according to the date and time you selected.
- 5 Move the OK button RIGHT to highlight the 'programme type' column then move UP or DOWN to select Films, News, Lifestyle, Sport, Children's Programmes, Entertainment or Education.
- 6 Move the OK button RIGHT or LEFT or press the OK button to update the programme information accordingly. If you selected tomorrow's date, 17:00 and Sport, you should now be able to view all the sports programmes being shown tomorrow from 5.00 pm onwards.
- 7 Press the button on the remote control to remove the EPG from the TV screen.

Tue 22 DEC 15:20:40		Press O.K. to view data for all available channels Press to return to programme list.		12	
22	9 34k	2	BBC 2 International Cricket ---- 13:35-18:20		
23	9	4	Channel 4 Racing From Epsom --- 14:00-16:30		
24	12 30k	5	C 5 Film: Rachel And The --- 15:30-17:10		
24	16:00	1	BBC 1 The Little Pet Shop --- 15:30-16:00		
25	18 40k	3	HITV Bernardo Watch --- 15:35-16:15		
26	21	1	BBC 1 Roger And Badger N --- 16:00-16:15		
27	24 10k	1	BBC 1 Raley Kippers Pw S --- 16:15-16:35		
27	3	3	HITV Subrina The Teenage --- 16:15-16:40		
28	Menu	4	BBC 1 Vets In Practice --- 16:30-17:30		

Tue 22 DEC 15:20:40		Press O.K. to view data for all available channels Press to return to programme list.		12	
22	9 34k	2	BBC 2 International Cricket ---- 13:35-18:20		
23	9	4	Channel 4 Racing From Epsom --- 14:00-16:30		
24	12 30k	5	C 5 Film: Rachel And The --- 15:30-17:10		
24	16:00	1	BBC 1 The Little Pet Shop --- 15:30-16:00		
25	18 40k	3	HITV Bernardo Watch --- 15:35-16:15		
26	21	1	BBC 1 Roger And Badger N --- 16:00-16:15		
27	24 10k	1	BBC 1 Raley Kippers Pw S --- 16:15-16:35		
27	3	3	HITV Subrina The Teenage --- 16:15-16:40		
28	Menu	4	BBC 1 Vets In Practice --- 16:30-17:30		

Electronic Programme Guide (EPG)

Before using the EPG recording facility, you will need to set up your VCR to receive the TV inputs from the scart plug (Please refer to your VCR instruction manual).

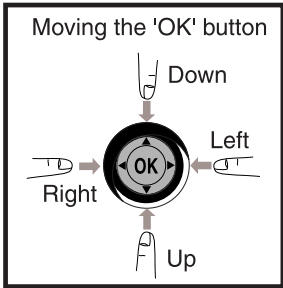

Recording Programmes

- 1 Press the button on the remote control to display the EPG on the TV screen.
- 2 Move the OK button RIGHT or LEFT to highlight the 'programme' column then move the OK button UP or DOWN to select your desired programme.
- 3 Press the OK button. If the programme is currently being broadcast, this programme will be displayed on your TV. If not, the 'TIMER' menu will be displayed on the TV screen.
- 4 At the bottom of the timer page you can see the symbols (back to EPG), (to record a programme) or (to set the programme to switch on automatically).
- 5 Move the OK button LEFT or RIGHT to select one of these symbols then press the OK button to confirm your selection. The EPG appears on screen with the relevant icon appearing next to the programme you selected in step 2.
- 6 If you wish to cancel a recording, select the relevant programme and press the OK button. A menu is displayed on screen requesting you to select 'Return' if you wish to continue to record the programme or 'Delete' if you wish to cancel the recording request.
- 7 After making your selection, press the OK button to confirm. The record icon disappears from the EPG if 'Delete' was selected in step 6.
- 8 If you have finished viewing programmes on your TV, press the I/⏻ button before the timer recording starts to leave your TV in standby mode for the timer settings to be activated. If, however, you wish to continue watching other programmes after setting a timer, you can do so by changing programmes in the normal way. If you are watching another programme when the timer is due to start a display will appear on screen advising you that, if you change channels, you automatically cancel the recording.
- 9 If you do not wish to cancel or view the recording, press the I/⏻ button whilst one of the displays are still on screen to leave your TV in standby mode. The standby indicator on the front of the TV will flash to show that the timer record operation is active. If, however, you choose to change programmes, you automatically cancel the recording.

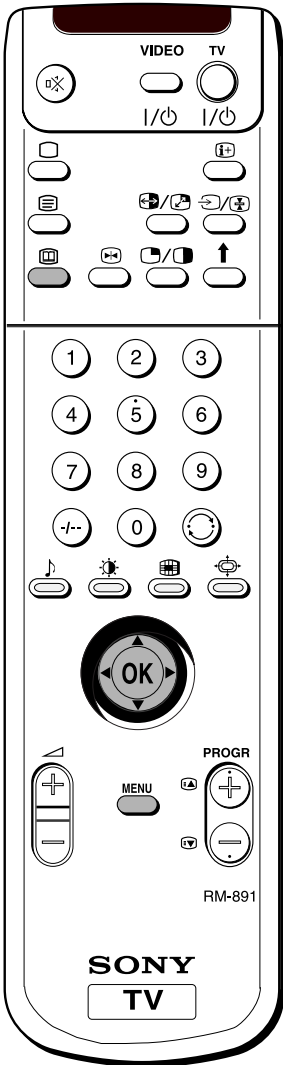

Tue 22 DEC 15:20:40		Press O.K. to view data for all available channels Press to return to programme list.		12
22	8 30	2	BBC 2 International Cricket - - - - 13:35 - 18:25	
23	9	4	Channel 4 Racing From Epsom - - - 14:00 - 16:30	
24	12 30	5	C 5 International Boxing - - - 15:30 - 17:10	
25	17:00	1	BBC 1 Tennis - - - 15:45 - 16:45	
26	18 30	3	HTV Motor Cross 15:55 - 16:25	
28	21	1	BBC 2 International Athletics - - - 19:00 - 21:15	
29	24 1	1	BBC 1 Speedway - - - 16:15 - 16:35	
27	3	3	HTV Swimming - - - 16:15 - 16:40	
28	Mon	4	BBC 1 Match of the day 16:30 - 17:30	

Tue 22 DEC 15:20:40		Press O.K. to view data for all available channels Press to return to programme list.		12
22	8 30	2	BBC 2 International Cricket - - - - 13:35 - 18:25	
23	9	4	Channel 4 Racing From Epsom - - - 14:00 - 16:30	
24	12 30	5	C 5 Film: Rachel And The ... 15:30 - 17:10	
25	16:00	1	BBC 1 The Little Pet Shop - - - 15:45 - 16:45	
26	18 30	3	HTV Bernards Watch 15:55 - 16:15	
28	21	1	BBC 1 Roger And Badger N 16:00 - 16:15	
29	24 1	1	BBC 1 Sunny Kippers For S - - - 16:15 - 16:35	
27	3	3	HTV Sabrina The Teenage - - - 16:15 - 16:40	
28	Mon	4	BBC 1 Vets In Practice 16:30 - 17:30	

Tue 22 DEC 15:20:40		Press O.K. to view data for all available channels Press to return to programme list.		12
Vets in Practice				
10 British Broadcasting Company		16:30 - 17:30	Tue 22 Dec	
Documentary series which follows veterinary graduates as they embark on their careers. Julio Richards has to deal with a terrier with behavioural problems and Steve Leonard encounters problems when he has to treat a golden labrador. Continues on Friday.				

Timer Recording Event will begin soon. During this event you cannot select the channel

Notes: Please note event recordings are dependent on broadcasters transmitting programmes to schedule.

If your video recorder (VCR) is not Smartlink-compatible, you will need to set your VCR to switch on and off automatically after setting the timer on the EPG.

If you want to change channel once a digital programme has started recording, select the channel by using the remote control buttons as normal. The message 'STOP RECORDING' will be displayed on screen. Either do nothing to allow the recording to continue or select the required channel once more while the message is still displayed on screen. The recording will then be cancelled.

Electronic Programme Guide (EPG)

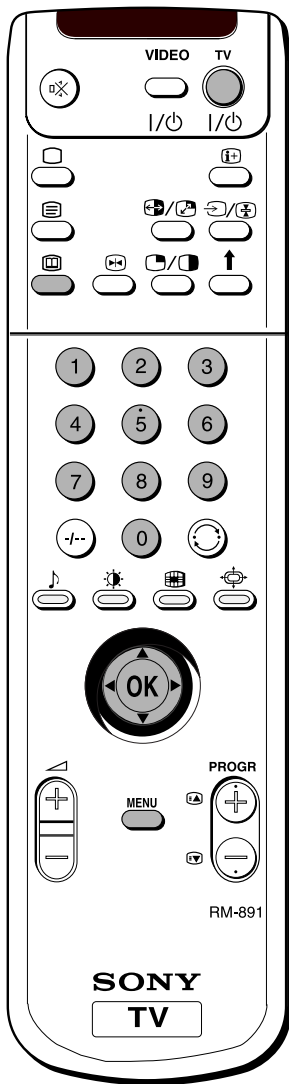
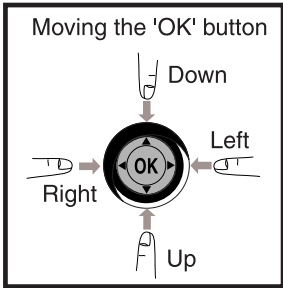

Setting The Manual Timer

- 1 Press the button on the remote control to display the EPG on the TV screen.
- 2 Move the OK button RIGHT or LEFT to highlight the 'programme type' column then move the OK button DOWN to select the timer symbol .
- 3 Press the OK button to display a screen of 9 programme slots, each one indicating that it is either free for programming, or that it has a programme already stored in it.
- 4 Move the OK button LEFT to enter the 'programme' column.
- 5 Move the OK button UP or DOWN to select a free row then press the OK button to display the Set Timer screen. This screen asks you to confirm the date, programme number, start time and stop time.
- 6 Move the OK button UP to select the date area then move the OK buttons UP or DOWN to enter the date.
- 7 Move the OK button RIGHT to confirm the date then press the OK button UP or DOWN to select the month.
- 8 Move the OK button RIGHT to confirm the month and to select the start time.
- 9 Move the OK button UP or DOWN to enter the time you wish the timer to switch on, preferably several minutes before your video recorder is due to start recording. Move the OK button RIGHT to confirm after each entry.
- 10 Move the OK button UP or DOWN to enter the time you want the timer to switch off, preferably after your video is due to stop recording.
- 11 Move the OK button RIGHT to confirm each entry, then move the OK button UP or DOWN to select the programme number.
- 12 Press the OK button to save the settings, then follow the on-screen instructions until you finally select to return to the Manual Timer Setup menu.
- 13 Select another available slot if you wish to record a further programme. Otherwise, move the OK button RIGHT to enter the 'programme type' column then press the OK button to return to the EPG.
- 14 If you have finished viewing programmes on your TV, press the button before the timer recording starts. This will leave your TV in standby mode for the timer settings to be activated. If, however, you wish to continue watching other programmes after setting the timer, you can do so by changing programmes in the normal way. If you are watching another programme when the timer is due to start, the display shown will appear on screen.
- 15 If you do not wish to view the recording, press the I/O button whilst the display is still on screen to leave your TV in standby mode. The standby indicator on the front of the TV will flash to show that the timer record operation is active. If, however, you choose to change programmes, you will automatically cancel the recording.

Tue 22 DEC 15:20:40		Press OK to view data for all available channels. Press to return to programme list.	12
22 Tue	6 36	2 BBC 2 International Cricket - - - - 13:35 - 16:25	
23 Wed	9	4 Channel 4 Racing From Epsom - - - 14:00 - 16:30	
24 Thu	12 36	5 C 5 Film: Rachel And The - - - 15:30 - 17:10	
25 Fri	16:00	1 BBC 1 The Little Pet Shop - - - 15:00 - 16:00	
26 Sat	18 36	3 ITV Bernard's Watch 15:00 - 16:15	
27 Sun	21	1 BBC 1 Bogey And Badger N 16:00 - 16:15	
28 Mon	24 36	1 BBC 1 Boxy Kippers For S - - 16:15 - 16:35	
	3	3 ITV Sabrina The Teenage - - - 16:15 - 16:40	
		4 BBC 1 Yes In Practice 16:30 - 17:30	

Tue 22 DEC 15:20:40		Timer event list. Press OK to view	2
22 Tue	6 36	Manual Timer Setup	
23 Wed	9	Manual Timer Setup	
24 Thu	12 36	Manual Timer Setup	
25 Fri	15	Manual Timer Setup	
26 Sat	18 36	Manual Timer Setup	
27 Sun	21	Manual Timer Setup	
28 Mon	24 36	Manual Timer Setup	

Tue 22 DEC 15:45:40		12	
Manual Timer Setup			
DATE	START	STOP	PROG NO
THU 24	DEC 16	00	10
Return			





Timer Recording Event will begin soon. During this event you cannot select the channel



Using Optional Equipment

Using the following instructions, you can connect a wide range of optional equipment to your TV.

Connecting Equipment to the TV

- 1 Switch off your TV at the mains.
- 2 Connect your equipment to the designated TV socket.
- 3 Plug in and switch on the TV then your additional equipment. It is important you switch on your TV first.
- 4 Press the MENU button on the remote control to display the menu on the TV screen.
- 5 Move the OK button on the remote control DOWN to select the symbol  on the menu screen then move RIGHT to enter the 'PRESET' menu.
- 6 Move the OK button DOWN to select 'Installation' then move RIGHT to enter the 'INSTALLATION' menu.
- 7 Move the OK button DOWN to select 'AV Preset' then move RIGHT to enter the 'AV PRESET' menu.
- 8 Move the OK button DOWN to select the socket that is being used to connect the optional equipment:

Socket	Symbol	Input signals
AV1		• Audio/video input signal through the Euro AV connector E
AV2		• Audio/video input signal through the Euro AV connector F
AV3		• Audio/video input signal through the sockets B , C or D
AV4		• Audio/video input signal through the Euro AV connector G

- 9 Move the OK button RIGHT to select the 'SOURCE' column.
- 10 Move the OK button DOWN to select 'AV' for this column then press the OK button to confirm.
- 11 Press the MENU button to remove the menu display from the TV screen.
- 12 Press the  button repeatedly on your remote control until the correct input symbol for your equipment appears on the TV screen (refer to the table above).
- 13 To return to normal TV picture, press the  button on the remote control.

Note: To avoid picture distortion, do not connect equipment to the **B** and **C** sockets when the scart connector **E**, **F** or **G** is in use.

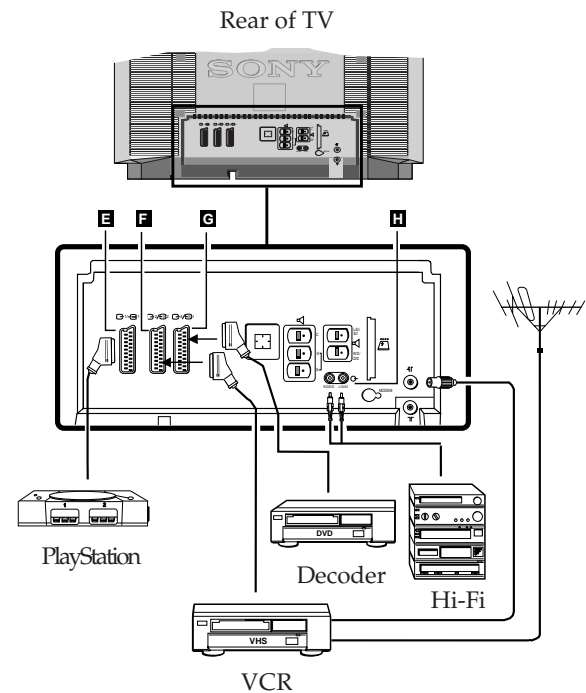
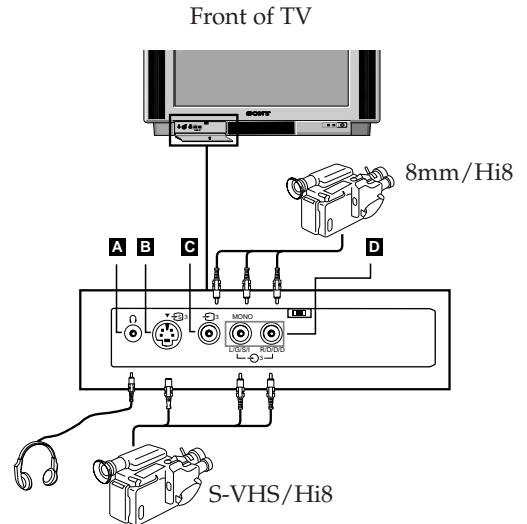

Using Optional Equipment

Additional Information When Connecting Equipment

Connecting a VCR

A. Standard connection for strong signal:

To record and playback digital programmes connect your VCR to the **F** socket using a scart lead (the VCR relies on the TV to convert the digital programmes to video and audio signals suitable for recording, which are then output from the TV through the scart connector).

To record analogue programmes on the VCR, connect your external aerial to the RF input socket on your VCR, then connect the VCR output lead to the upper aerial socket marked **3** on the TV.

B. Alternative connection for weak signal areas:

If poor reception occurs due to weak signals, then the following configuration is recommended (to avoid the possibility of the VCR affecting the TV signal quality):

To record and playback digital programmes connect your VCR to the **F** socket using a scart lead.

To record analogue programmes on the VCR, connect your external aerial to the upper aerial socket marked **3** on the TV, then connect a lead from the RF input of the VCR to the lower aerial socket marked **1** on the TV.

Note: In this configuration, the TV must be switched on or in standby for the signal to pass through the TV to the VCR.

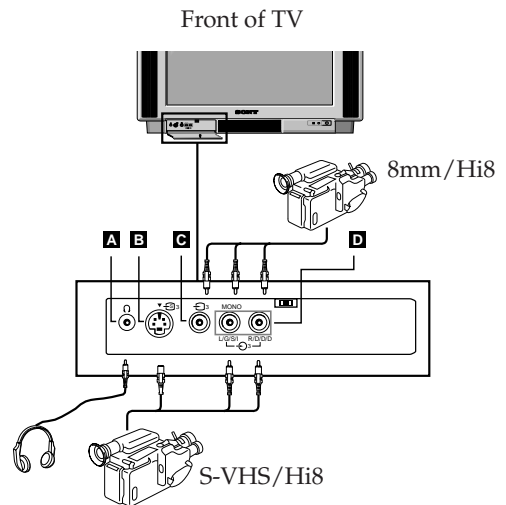

Connecting Headphones

Plug in your headphones to the **A** socket on the front of the TV set.

Connecting to External Audio Equipment

Plug in your Hi-Fi equipment to the **H** sockets on the rear of the TV if you wish to amplify the audio output from the TV.

The output level of signals from the **H** socket is adjusted by changing the headphone volume. Refer to the 'Adjusting the Sound' section of this manual.

For Mono Equipment

Connect the phono plug to the L/G/S/I socket on the front of the TV and select the **3** input signal using the instructions on the previous page.

Finally, refer to the 'Adjusting the Sound' section of this manual and select 'A' on the sound menu screen.

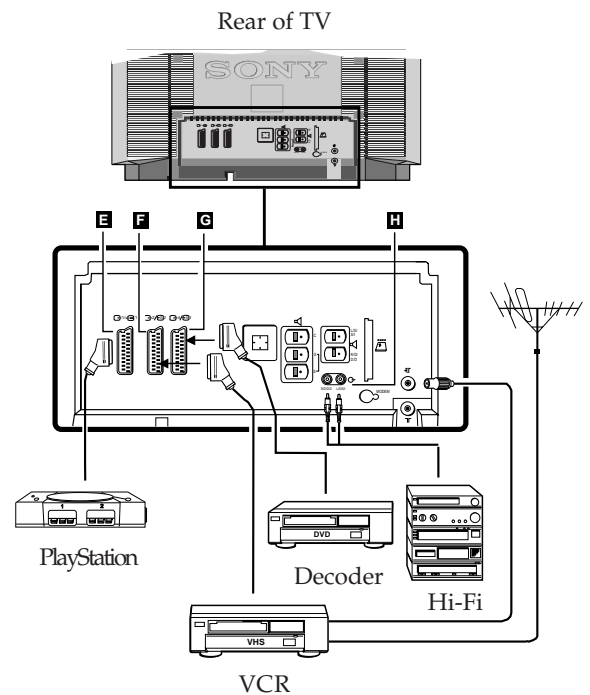

Selecting The Output Source For The Scart Socket **F**

- 1 Press the MENU button on the remote control to display the menu on the TV screen.
- 2 Move the OK button DOWN to select the **F** symbol on the menu screen then move RIGHT to enter the 'VIDEO CONNECTION' menu screen.
- 3 Move the OK button DOWN to highlight 'TV Screen' (input source for the TV screen) or 'AV2 Output' (output source for **2**/**2**) then move RIGHT to confirm.
- 4 Move the OK button DOWN to select the desired source (see below) then press the OK button to confirm:

TV Screen: TV, AV1, RGB, AV2, YC2, AV3, YC3, AV4, YC4
 Output: TV, AV1, AV2, YC2, AV3, YC3, AV4, YC4

- 5 Press the MENU button to remove the menu from the TV screen.

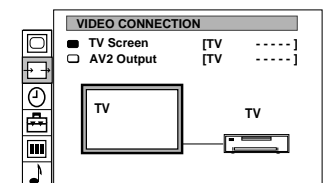
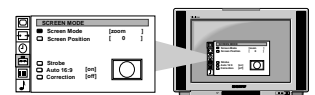

Using Optional Equipment

Before using the 'Smartlink' facility, you will need to set up your VCR to receive the TV inputs from the scart plug (Please refer to your VCR instruction manual).

Using Smartlink

With Smartlink your TV can communicate with a connected VCR. To enjoy Smartlink, connect your VCR (which supports Smartlink, NexTVView Link, Easy Link or Megalagic) to the AV2 socket **F** using a fully-wired 21-pin SCART cable.

When viewing analogue channels on the TV, you can download data such as the programme table from your TV to the VCR by following the instructions below:

1. Press the MENU button on the remote control to display the menu on the TV screen.
2. Move the OK button on the control DOWN to select the  symbol on the screen then move RIGHT to enter the 'PRESET' menu.
3. Move the OK button DOWN to select 'Installation' on the screen then move RIGHT to enter the 'INSTALLATION' menu.
4. Move the OK button DOWN to select 'Smartlink Setup' then move RIGHT to enter the SMARTLINK SETUP menu.
5. With the SMARTLINK SETUP menu on the TV screen, press the OK button to download the preset data from your TV to the VCR.
6. Once download is complete, press the MENU button to remove the menu from the TV screen.

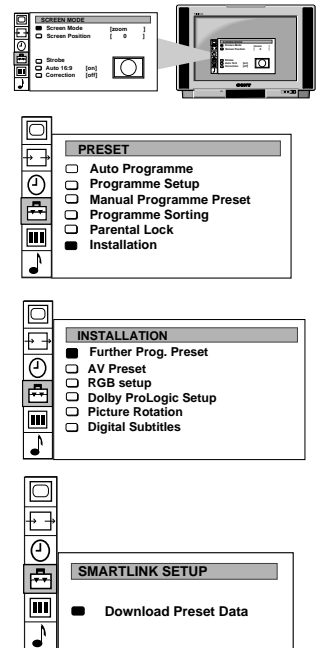

For more information on Smartlink please refer to your VCR instruction manual.

Note: If you want to change channel once a digital programme has started recording, select the channel by using the remote control buttons as normal. The message 'STOP RECORDING' will be displayed on screen. Either do nothing to allow the recording to continue or select the required channel once more while the message is still displayed on screen. The recording will then be cancelled.

Specifications

TV system

I

Colour system

PAL
NTSC 3.58, 4.43 (only Video In)







Channel coverage

UHF: B21-B69





Picture tube

KV-28DS60U/28DS65U
FD Trinitron WIDE
Approx. 71 cm (28 inches) (Approx. 66 cm picture measured diagonally),
102° deflection
KV-32DS60U/32DS65U
FD Trinitron WIDE
Approx. 82 cm (32 inches) (Approx. 76 cm picture measured diagonally),
102° deflection

Rear Terminals

-  1 /  1 21-pin Euro connector (CENELEC standard) including audio/video input, RGB input, TV audio/video output
-  2 /  2 21-pin Euro connector (CENELEC standard) including audio/video input, S-video input, Monitor audio/video output
-  4 /  4 21-pin Euro connector (CENELEC standard) including audio/video input, S-video input, Monitor audio/video output
-  Audio outputs - phono jacks
- MODEM Modem Connector

Front Terminals

-  3 video input - phono jack
-  3 audio inputs - phono jacks
-  3 S video input - 4 pin DIN
-  Headphones jack - minijack stereo

Sound output:

Left/Right	2 x 30 W (music power) 2 x 15W (RMS)
Centre	1x30W (music power) 1x15W (RMS)
Surround	2x15W (music power) 2x 7.5 (RMS)

Power consumption

KV-28DS60U/28DS65U	200 W
KV-32DS60U/32DS65U	200 W

Dimensions (wxhxd)

KV-28DS60U/28DS65U	Approx. 773 x 501 x 526 mm
KV-32DS60U/32DS65U	Approx. 867 x 564 x 558 mm

Weight

KV-28DS60U/28DS65U	Approx. 53.0 kg
KV-32DS60U/32DS65U	Approx. 71.5 kg

Accessories supplied













RM-891 or RM-892 Remote Control (1)
IEC designated size AA battery (2)
Surround speaker (2)

Other features

TELETEXT
DNR (Digital Noise Reduction)
Dolby ProLogic Surround System
Graphic Equalizer
NICAM Stereo
Smartlink

Troubleshooting

Problem	Cause
No picture, no sound.	<ul style="list-style-type: none"> • Power off. • TV in standby. • Aerial disconnected.
Poor or no picture (screen is dark), but good sound. No picture on any channel after digital tuning.	<ul style="list-style-type: none"> • Picture preset level adjustment. • No digital transmissions in your area. • No digital transmissions from the transmitter you are currently using. • Weak signal. • Unsuitable aerial. • Scrambled/subscription-only channel. • Programme used only for data (no picture or sound). • Programme not being transmitted. • Digital mode Timer Record active (regular flash). • Fault (irregular flash).
Some channels are blank.	<ul style="list-style-type: none"> • Volume control.
Standby indicator flashing.	<ul style="list-style-type: none"> • Wrong external mode selected on an RGB video source. • Colour level setting.
Good picture, no sound.	<ul style="list-style-type: none"> • Batteries low. • Inputs from external equipment not switched off.
Poor picture quality.	
No colour on colour programmes.	
Remote control does not function.	
Distorted picture when changing programmes or selecting Teletext.	

Cause	Solution
Power off. TV in Standby.	<ul style="list-style-type: none"> • Plug in the TV. • Press the  button on the front of the TV. • If the  indicator is on, press the  button or a programme number on the remote control.
Aerial disconnected. Picture level adjustment.	<ul style="list-style-type: none"> • Check the aerial connection. • Select  on the TV menu system then adjust the brightness, picture and colour balance levels. • Lift the flap of the remote control and press  to return to the preset factory levels.
No digital transmissions in your area.	<ul style="list-style-type: none"> • Switch the TV to analogue mode using the 'Automatically tuning the TV' section of this instruction manual then contact a local installer to find out when digital transmissions start in your area.
No digital transmissions from the transmitter you are currently using Unsuitable aerial.	<ul style="list-style-type: none"> • Contact a local installer to find out which transmitter you should be pointing your aerial at. • Change your aerial to cover the channels used by digital programmes (Contact a local installer).
Weak signal.	<ul style="list-style-type: none"> • Ensure aerial is plugged directly into the TV (not through other equipment). • Ensure aerial is correctly aligned to transmitter. • Upgrade to a higher gain aerial.
Scrambled/subscription-only channel. Programme information without picture or sound.	<ul style="list-style-type: none"> • Subscribe to pay-per-view broadcaster. • See "Skipping programme position" section. • See "Exchanging programme positions" section.
Fault.	<ul style="list-style-type: none"> • Do not open the cabinet, refer to qualified person. • Contact your nearest Sony Service Centre.
Volume control.	<ul style="list-style-type: none"> • Press the  + button on the remote control. • If  is displayed on the screen, press the  button on the remote control.
Wrong external mode selected.	<ul style="list-style-type: none"> • Press the  button repeatedly on the remote control until the RGB symbol  is displayed on screen.
Colour level setting.	<ul style="list-style-type: none"> • Select  in the TV menu system then adjust the colour setting. • Lift the flap of the remote control and press  to return to the preset factory level.

- If you continue to have these problems, have your TV serviced by qualified personnel.
- Never open the casing yourself.