

LCD Digital Colour TV

Operating Instructions

⚠ Before operating the TV, please read the "Safety information" section of this manual.
Retain this manual for future reference.

DVB[®]
Digital Video
Broadcasting

KDL-W40A12U

BRAVIA



NOTICE FOR CUSTOMERS

A moulded plug complying with BS1363 is fitted to this equipment for your safety and convenience.

Should the fuse in the plug supplied need to be replaced, a 13 AMP fuse approved by ASTA or BSI to BS 1362 (i.e., marked with ⚡ or ⚡) must be used.

When an alternative type of plug is used it should be fitted with a 13 AMP FUSE, otherwise the circuit should be protected by a 13 AMP FUSE at the distribution board.

If the plug supplied with this equipment has a detachable fuse cover, be sure to attach the fuse cover after you change the fuse. Never use the plug without the fuse cover. If you should lose the fuse cover, please contact your nearest Sony service station.

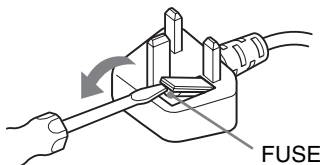

How to replace the fuse

Open the fuse compartment with a blade screwdriver, and replace the fuse.

WARNING

- To prevent the risk of electric shock, do not insert the plug cut off from the mains lead into a socket outlet. This plug cannot be used and should be destroyed.
- To prevent the risk of fire or electric shock, do not expose the TV set to rain or moisture.
- Dangerously high voltages are present inside the TV set. Do not open the cabinet. Refer servicing to qualified personnel only.

Introduction

Thank you for choosing this Sony product. Before operating the TV, please read this manual thoroughly and retain it for future reference.

Trademark information

- **DVB** is a registered trademark of the DVB project.
- “PlayStation” is a trademark of Sony Computer Entertainment, Inc.
- TruSurround technology is used as a virtualizer for Dolby Virtual Surround.
- TruSurround, SRS and  symbol are trademarks of SRS Labs, Inc. TruSurround technology is incorporated under license from SRS Labs, Inc.
- **HDMI** This TV incorporates High-Definition Multimedia Interface (HDMI™) technology. HDMI, the HDMI logo and High-Definition Multimedia Interface are trademarks or registered trademarks of HDMI Licensing LLC.

Table of Contents

Safety information	4
Precautions	7
Disposal of the TV set.....	7
Overview of the remote	8
Overview of the TV buttons and indicators	9

Getting Started

1: Checking the accessories	10
2: Inserting batteries into the remote.....	10
3: Connecting an aerial/VCR.....	11
4: Preventing the TV from toppling over....	12
5: Switching on the TV	12
6: Auto-tuning the TV	13

Watching TV **DVB** : for digital channels only

Watching TV.....	14
Checking the Digital Electronic Programme Guide (EPG) DVB	16
Using the Favourite list DVB	18
Viewing pictures from connected equipment	19

Using the Menu

Navigating through menus	19
Overview of the menus.....	20
Picture Adjustment menu	21
Mode	21
Contrast/Brightness/Colour/Hue/Sharpness/Backlight.....	21
Colour Tone	21
Noise Reduction	22
Dynamic Picture	22
Gamma Correction.....	22
Reset	22
Sound Adjustment menu	23
Effect (sound effect).....	23
Treble/Bass/Balance	23
Auto Volume	23
Dual Sound.....	24
Woofer Level.....	24
🎧 Volume (headphone volume).....	24
🎧 Dual Sound	24

Reset	24
Screen Control menu.....	25
Auto Format.....	25
Screen Format.....	25
Screen Shift.....	25
Features menu	26
Power Saving	26
Speaker	26
AV2 Output.....	26
Picture Off	27
Logo Illumination.....	27
Timer menu	28
Sleep Timer	28
Auto Shutoff.....	28
Set Up menu.....	29
Auto Start Up.....	29
Auto Tuning (Analogue mode only)	29
Programme Sorting (Analogue mode only).....	29
Programme Labels (Analogue mode only)	30
AV Preset.....	30
Manual Programme Preset (Analogue mode only).....	30
Digital Set Up DVB	32

Using Optional Equipment

Connecting optional equipment	35
Programming the remote	37

Additional Information

Specifications	39
Troubleshooting.....	40
Index.....	43

Safety information

Mains lead

- Unplug the mains lead when moving the TV set. Do not move the TV set with the mains lead plugged in. It may damage the mains lead and result in fire or electric shock.
- If you damage the mains lead, it may result in fire or electric shock.
 - Do not pinch, bend, or twist the mains lead excessively. The core conductors may be exposed or broken, causing a short-circuit, which may cause fire or electric shock.
 - Do not modify or damage the mains lead.
 - Do not put anything heavy on the mains lead. Do not pull the mains lead.
 - Keep the mains lead away from heat sources.
 - Be sure to grasp the plug when disconnecting the mains lead.
- If the mains lead is damaged, stop using it and ask your dealer or Sony service centre to exchange it.
- Do not use the supplied mains lead on any other equipment.
- Use only an original Sony mains lead, not other brands.

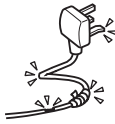
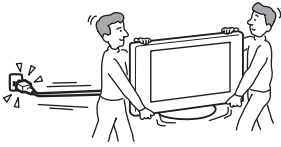

Mains lead/cable protection

Pull out the mains lead/cable by the plug. Do not pull on the mains lead/cable itself.

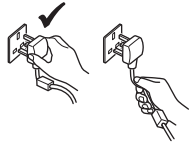

Mains

Do not use a poor fitting mains socket. Insert the plug fully into the mains socket. A poor fit may cause arcing and result in fire. Contact your electrician to have the mains socket changed.



Optional accessories

Observe the following when installing the TV set using a stand or wall-mount bracket. If you do not do so, the TV set may fall and cause serious injury.

- Use the specified wall-mount bracket or stand.
- Secure the TV set properly, following the instructions supplied with your stand or wall-mount bracket when installing the TV set.
- Be sure to attach the brackets supplied with your stand.



Installation

If the TV set is to be installed on a wall, have the installation carried out by qualified service men. Improper installation may render the TV set unsafe.

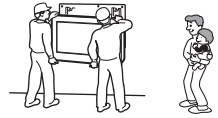

Medical institutions

Do not place this TV set in a place where medical equipment is in use. It may cause malfunction of medical instruments.

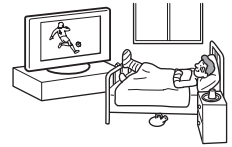

Carrying

- Before carrying the TV set, disconnect all the cables from the TV set.
- When you carry the TV set by hand, hold the TV set as illustrated on the right. If you do not do so, the TV set may fall and be damaged or cause serious injury. If the TV set has been dropped or damaged, have it checked immediately by qualified service personnel.
- When transporting it, do not subject the TV set to jolts or excessive vibration. The TV set may fall and be damaged or cause serious injury.
- When you carry the TV set in for repair or when you move it, pack it using the original carton and packing material.
- Carrying the TV set requires two or more people.

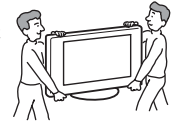

Ventilation

- Never cover the ventilation holes in the cabinet. It may cause overheating and result in fire.
- Unless proper ventilation is provided, the TV set may gather dust and get dirty. For proper ventilation, observe the following:
 - Do not install the TV set turned backwards or sideways.
 - Do not install the TV set turned over or upside down.
 - Do not install the TV set on a shelf or in a closet.
 - Do not place the TV set on a rug or bed.
 - Do not cover the TV set with cloth, such as curtains, or items such as newspapers, etc.
- Leave some space around the TV set. Otherwise, air-circulation may be inadequate and cause overheating, which may cause fire or damage to the TV set.

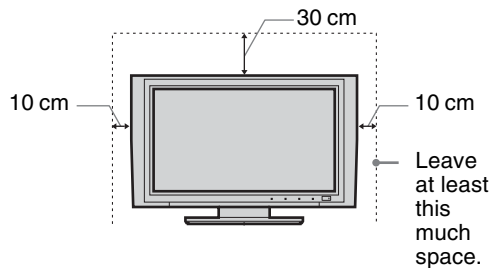

- When installing the TV set on the wall, leave at least 10 cm space from the bottom of the TV set.
- Never install the TV set as follows:

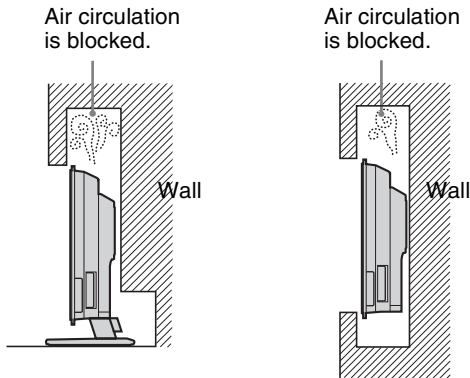

Ventilation holes

Do not insert anything in the ventilation holes. If metal or liquid is inserted in these holes, it may result in fire or electric shock.



Placement

- Never place the TV set in hot, humid or excessively dusty places.
- Do not install the TV set where insects may enter.
- Do not install the TV set where it may be exposed to mechanical vibration.
- Place the TV set on a stable, level surface. Otherwise, the TV set may fall and cause injury.
- Do not install the TV set in a location where it may protrude, such as on or behind a pillar, or where you might bump your head on it. Otherwise, it may result in injury.



Water and moisture

- Do not use this TV set near water – for example, near a bathtub or shower room. Also do not expose to rain, moisture or smoke. This may result in fire or electric shock.
- Do not touch the mains lead and the TV set with wet hands. Doing so may cause electric shock or damage to the TV set.



Moisture and flammable objects

- Do not let this TV set get wet. Never spill liquid of any kind on the TV set. If any liquid or solid object does fall through openings in the cabinet, do not operate the TV set. It may result in electric shock or damage to the TV set. Have it checked immediately by qualified service personnel.
- To prevent fire, keep flammable objects (candles, etc.) and electric bulbs away from the TV set.

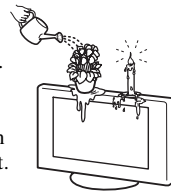

Oils

Do not install this TV set in restaurants that use oil. Dust absorbing oil may enter and damage the TV set.

Fall

Place the TV set on a secure, stable stand. Do not hang anything on the TV set. If you do, the TV set may fall from the stand or wall-mount bracket, causing damage or serious injury.

Do not allow children to climb on the TV set.



Vehicle or ceiling

Do not install this TV set in a vehicle. The motion of the vehicle may cause the TV set to fall down and cause injury. Do not hang this TV set from the ceiling.

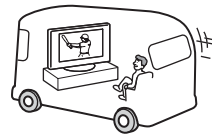

Ships and other vessels

Do not install this TV set on a ship or other vessel. If the TV set is exposed to seawater, it may cause fire or damage the TV set.

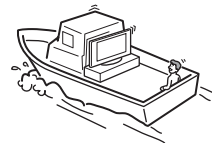

Outdoor use

- Do not expose the TV set to direct sunlight. The TV set may heat up and this may result in damage to the TV set.
- Do not install this TV set outdoors.



Wiring

- Unplug the mains lead when wiring cables. When hooking up, be sure to unplug the mains lead for your safety.
- Take care not to catch your feet on the cables. It may damage the TV set.

Cleaning

- Unplug the mains lead when cleaning the mains plug and this TV set. If you do not, it may result in electric shock.
- Clean the mains plug regularly. If the plug is covered with dust and it picks up moisture, its insulation may deteriorate and result in fire.



Lightning storms

For your own safety, do not touch any part of the TV set, mains lead, or aerial lead during lightning storms.



Continued

Damage requiring service

If the surface of the TV set cracks, do not touch it until you have unplugged the mains lead. Otherwise electric shock may result.

Servicing

Do not open the cabinet. Entrust the TV set to qualified service personnel only.



Small accessories removal and fittable

Keep accessories out of children's reach. If they are swallowed, choking or suffocation may occur. Call a doctor immediately.

Broken glass

Do not throw anything at the TV set. The screen glass may explode by the impact and cause serious injury.



When not in use

For environmental and safety reasons, it is recommended that the TV set is not left in standby when unused. Disconnect from the mains. However, some TV sets may have features which need the TV set to be left in standby to work correctly. The instructions in this manual will inform you if this applies.



Viewing the TV

- To view the TV comfortably, the recommended viewing position is from four to seven times the screen's vertical length away from the TV set.
- View the TV in moderate light, as viewing the TV in poor light strains your eyes. Watching the screen continuously for long periods of time can also strain your eyes.
- If the angle of the TV set is to be adjusted, steady the base of the stand with your hand to prevent the TV set from becoming separated from the stand. Be careful not to get your fingers caught between the TV set and the stand.

Volume adjustment

- Adjust the volume so as not to trouble your neighbours. Sound carries very easily at night time. Therefore, closing the windows or using headphones is suggested.
- When using headphones, adjust the volume so as to avoid excessive levels, as hearing damage may result.

Overloading

This TV set is designed to operate on a 220–240 V AC supply only. Take care not to connect too many appliances to the same mains socket as this could result in fire or electric shock.

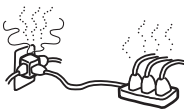

Heat

Do not touch the surface of the TV set. It remains hot, even after the TV set has been turned off for some time.

Corrosion

If you use this TV set near the seashore, salt may corrode metal parts of the TV set and cause internal damage or fire. It may also shorten the life of the TV set. Steps should be taken to reduce the humidity and moderate the temperature of the area where the TV set is located.

Precautions

LCD Screen

- Although the LCD screen is made with high-precision technology and 99.99% or more of the pixels are effective, black dots may appear or bright points of light (red, blue, or green) may appear constantly on the LCD screen. This is a structural property of the LCD panel and is not a malfunction.
- Do not expose the LCD screen surface to the sun. Doing so may damage the screen surface.
- Do not push or scratch the front filter, or place objects on top of this TV set. The image may be uneven or the LCD panel may be damaged.
- If this TV set is used in a cold place, a smear may occur in the picture or the picture may become dark. This does not indicate a failure. These phenomena disappear as the temperature rises.
- Ghosting may occur when still pictures are displayed continuously. It may disappear after a few moments.
- The screen and cabinet get warm when this TV set is in use. This is not a malfunction.
- The LCD contains a small amount of liquid crystal and mercury. The fluorescent tube used in this TV set also contains mercury. Follow your local ordinances and regulations for disposal.

Fluorescent lamp

This TV set uses a special fluorescent lamp as its light source. If the screen image becomes dark, flickers, or does not appear, the fluorescent lamp has worn out and the LCD screen should be replaced. For replacement, consult qualified service personnel.

Installing the TV set

- Do not install the TV set in places subject to extreme temperature, for example in direct sunlight, or near a radiator, or heating vent. If the TV set is exposed to extreme temperature, the TV set may overheat and cause deformation of the casing or cause the TV set to malfunction.
- The TV set is not disconnected from the mains when the TV set is switched off. To disconnect the TV set completely, pull the plug from the mains.
- To obtain a clear picture, do not expose the screen to direct illumination or direct sunlight. If possible, use spot lighting directed down from the ceiling.
- Do not install optional components too close to the TV set. Keep optional components at least 30 cm away from the TV set. If a VCR is installed in front of the TV set or beside the TV set, the picture may become distorted.

Handling and cleaning the screen surface/cabinet of the TV set

The screen surface is finished with a special coating to prevent strong light reflections.

To avoid material degradation or screen coating degradation, observe the following precautions.

- Do not push on the screen, scratch it with a hard object, or throw anything at it. The screen may be damaged.
- Do not touch the display panel after operating the TV set continuously for a long period as the display panel becomes hot.
- We recommend that the screen surface be touched as little as possible.
- To remove dust from the screen surface/cabinet, wipe gently with a soft cloth. If dust is persistent, wipe with a soft cloth slightly moistened with a diluted mild detergent solution. You can wash and repeatedly use the soft cloth.
- Never use any type of abrasive pad, alkaline/acid cleaner, scouring powder, or volatile solvent, such as alcohol, benzene, thinner or insecticide. Using such materials or maintaining prolonged contact with rubber or vinyl materials may result in damage to the screen surface and cabinet material.
- The ventilation holes can accumulate dust over time. To ensure proper ventilation, we recommend removing the dust periodically (once a month) using a vacuum cleaner.

Disposal of the TV set



Disposal of Old Electrical & Electronic Equipment (Applicable in the European Union and other European countries with separate collection systems)

This symbol on the product or on its packaging indicates that this product shall not be treated as household waste. Instead it shall be handed over to the applicable collection point for the recycling

of electrical and electronic equipment. By ensuring this product is disposed of correctly, you will help prevent potential negative consequences for the environment and human health, which could otherwise be caused by inappropriate waste handling of this product. The recycling of materials will help to conserve natural resources. For more detailed information about recycling of this product, please contact your local Civic office, your household waste disposal service or the shop where you purchased the product.

Overview of the remote

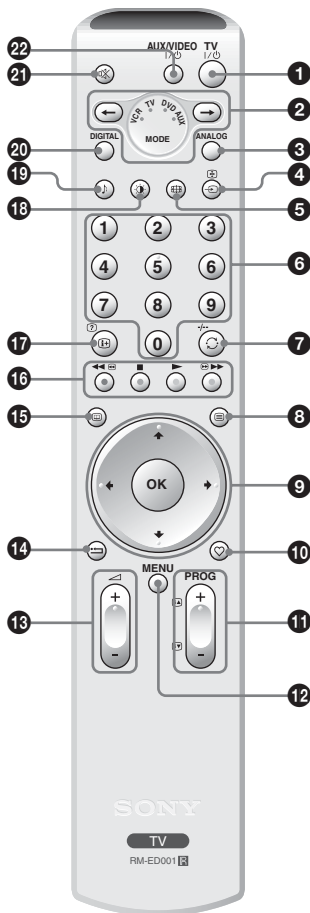

- 1 TV I/⏻ – TV standby**
Switches off the TV temporarily, and on from standby mode.
- 2 Media selector (page 37)**
Selects which equipment you want to operate. A green light will be momentarily lit to show which one you have selected.
- 3 ANALOG – Analogue mode (page 14)**
- 4 ↵/⏻ – Input select / Text hold**
 - In TV mode (page 19): Selects the input source from equipment connected to the TV sockets.
 - In Analogue Text mode (page 15): Holds the current page.
- 5 📺 – Screen mode (page 15)**
- 6 Number buttons**
 - In TV mode: Selects channels. For channel numbers 10 and above, enter the second digit within two seconds.
 - In Analogue Text mode: Enters the three digit page number to select the page.
- 7 ⏪ / - / - - – Previous channel / VCR double digit**
 - In TV mode: Returns to the previous channel watched (for more than five seconds).
 - In VCR mode: Selects the double-digit channels for Sony's VCR (e.g., for 23, press -/- and then the 2 and 3).
- 8 ☰ – Text (page 15)**
- 9 ⬆️/⬇️/⬅️/➡️/OK (page 15, 19)**
- 10 ♡ – Favourite (page 18)**
- 11 PROG +/- (page 14)**
 - In TV mode: Selects the next (+) or previous (-) channel.
 - In Analogue Text mode: Selects the next (+) or previous (-) page.
- 12 MENU (page 19)**
- 13 🔊 +/- – Volume**

- 14 📄 – Digital Text off (page 15)**
- 15 📖 – EPG (Digital Electronic Programme Guide) (page 16)**
- 16 Coloured buttons**
 - In digital mode (page 16, 18): Selects the options at the bottom of the Favourite and EPG digital menus.
 - In VCR and DVD mode (page 37): Operates the main functions of your VCR or DVD.
- 17 ⓘ/❓ – Info / Text reveal**
 - In digital mode: Displays brief details of the programme currently being watched.
 - In analogue mode: Displays information such as current channel number and screen mode.
 - In Analogue Text mode (page 15): Reveals hidden information (e.g., answers to a quiz).
- 18 🌞 – Picture mode (page 21)**
- 19 🎵 – Sound effect (page 23)**
- 20 DIGITAL – Digital mode (page 14)**
- 21 🚫 – Mute (page 14)**
- 22 AUX/VIDEO I/⏻**

Switches your equipment on/off, as programmed on the remote (page 37).

Tip

The ⬆️/⬇️/⬅️/➡️, 🔊 +/-, PROG+, and number 5 buttons have tactile dots. Use the tactile dots as references when operating the TV.

Overview of the TV buttons and indicators

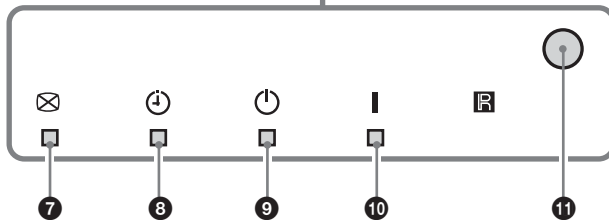
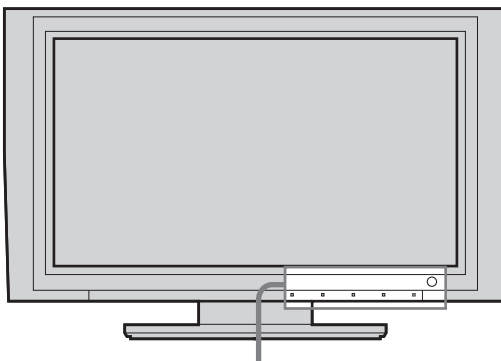
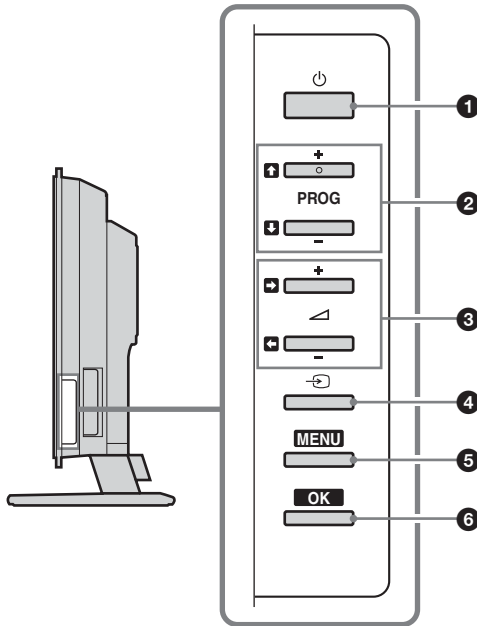

- 1** – **Power**
 Switches the TV on or off.
- 2** **PROG +/-**
 - In TV mode: Selects the next (+) or previous (-) channel.
 - In TV menu: Moves through the options up () or down ()
- 3** +/-
 - Increases (+) or decreases (-) the volume.
 - In TV menu: Moves through the options left () or right ()
- 4** – **Input select (page 19)**
 Selects the input source from equipment connected to the TV sockets.
- 5** **MENU (page 19)**
- 6** **OK (page 19)**
- 7** – **Picture Off indicator (page 27)**
 Lights up in green when the picture is switched off. Only the picture is switched off (the sound remains unchanged).
- 8** – **Timer indicator (page 28)**
 Lights up in orange when the timer is set.
- 9** – **Standby indicator**
 Lights up in red when the TV is in standby mode.
- 10** **I** – **Power indicator**
 Lights up in green when the TV is switched on.
- 11** **Remote control sensor**

1: Checking the accessories

Remote RM-ED001 (1)

Size AA batteries (R6 type) (2)

Coaxial cable (1)



Mains lead (Type BF) (1)

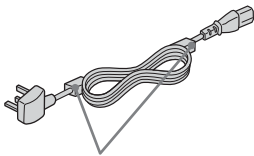

Do not remove these ferrite cores.

Bundling band (1) and screw (1)



2: Inserting batteries into the remote

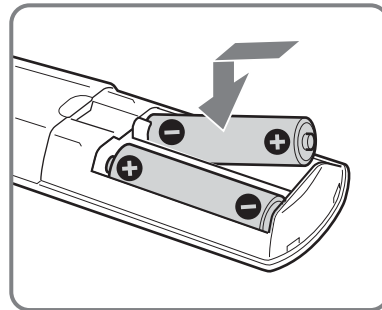
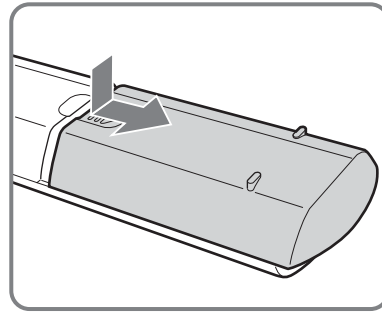

Notes

- Observe the correct polarity when inserting batteries.
- Dispose of batteries in an environmentally friendly way. Certain regions may regulate disposal of the battery. Please consult your local authority.
- Do not use different types of batteries together or mix old and new batteries.
- Handle the remote with care. Do not drop or step on it, or spill liquid of any kind onto it.
- Do not place the remote in a location near a heat source, or in a place subject to direct sunlight, or in a damp room.

3: Connecting an aerial/VCR

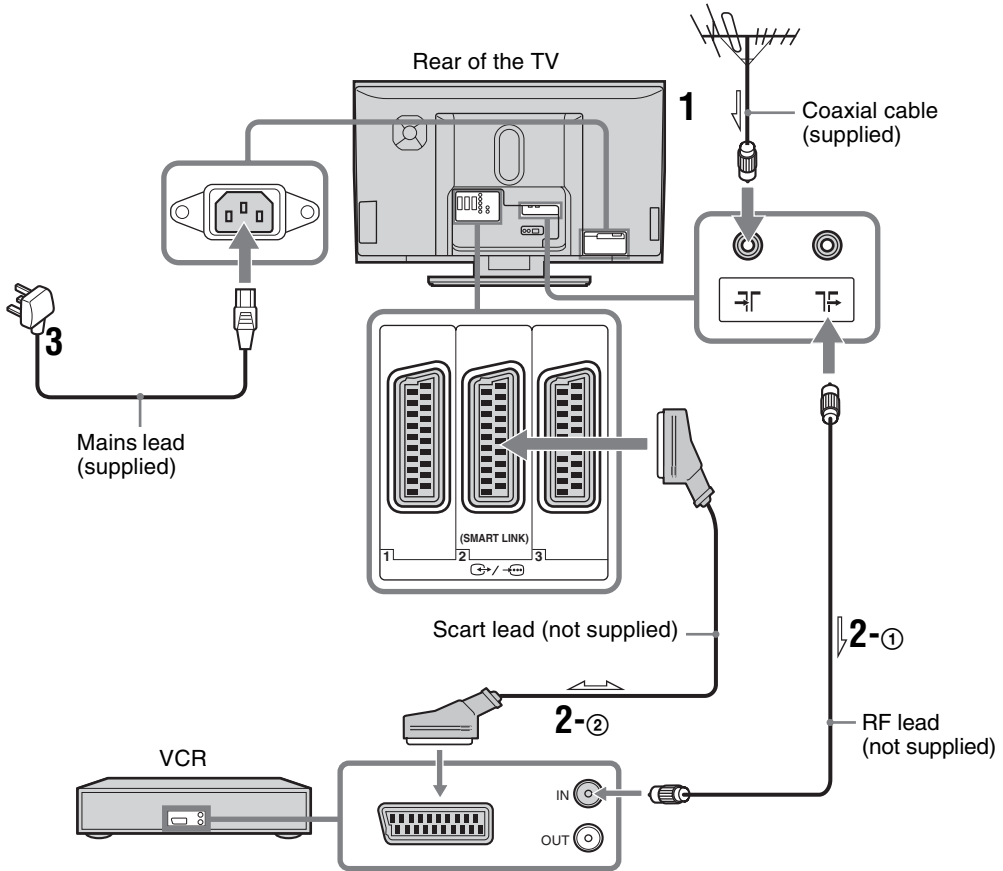

- 1** Connect your aerial to the socket on the rear of the TV.

If connecting to an aerial only

Go to step 3.

- 2** Connect your VCR.

- ① Connect the socket on the rear of the TV to the input socket on your VCR with the RF lead.
- ② Connect the scart socket on your VCR to the scart socket on the rear of the TV with a scart lead.

- 3** Connect the supplied mains lead to the AC IN socket on the rear of the TV.

Note

Do not connect the mains lead to your mains socket until all connections are complete.

- 4** Bundle the cable.

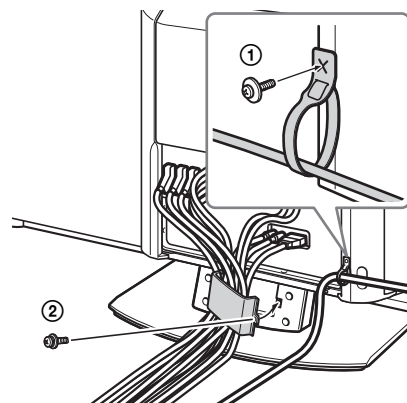

- ① Run the mains lead through the bundling band and attach to the right of the rear panel with the supplied screw.
- ② Remove the screw to open one side of the cable cover and run the cables through, then tighten the screw again.

4: Preventing the TV from toppling over

For additional stability, the anchor attachments on the back of the TV can be used to secure the TV to a wall. (Do not remove the anchor attachments.)

- 1 Run suitable cables through the holes of both anchor attachments on the back of the TV.

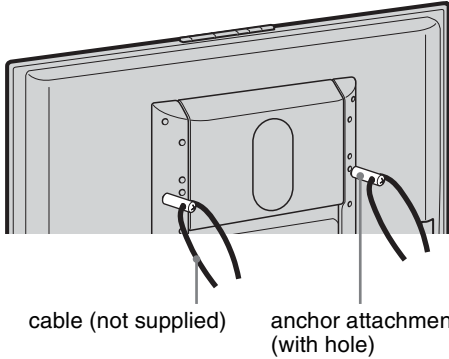

- 2 Anchor the cables to a stable surface such as a wall or pillar.

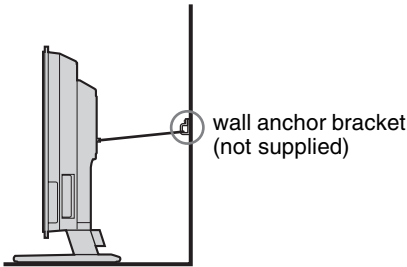

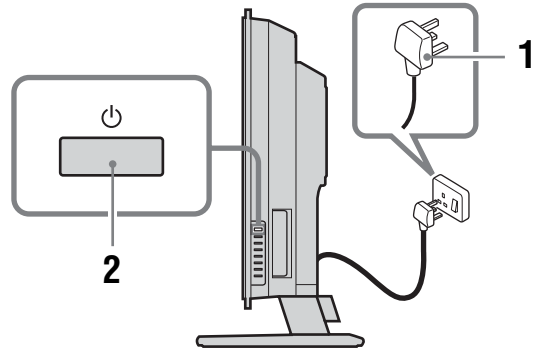

5: Switching on the TV



- 1 Connect the TV to your mains socket (220-240V AC, 50Hz).

- 2 Press  on the TV (right side).

When you switch on the TV for the first time, the message confirming the TV start auto-tuning appears on the screen, then go to “6: Auto-tuning the TV” on page 13.

When the TV is in standby mode (the  (standby) indicator on the TV (front) is red), press TV   on the remote to switch on the TV.

6: Auto-tuning the TV

When you switch on the TV for the first time, a message confirming the TV start auto-tuning appears on the screen.

You must tune the TV to receive channels (TV broadcasts). Do the following to search and store all available channels.



- 1 Press OK to select “Yes”.

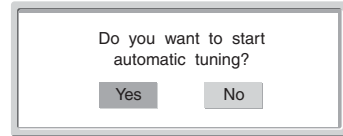

Digital auto-tune display

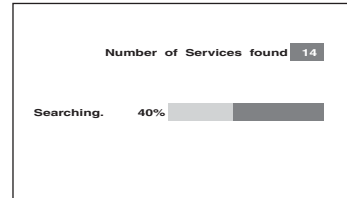

Analogue auto-tune display

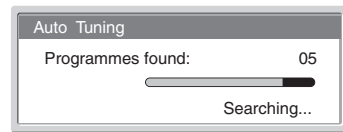

The TV starts searching for all available digital channels, followed by all available analogue channels. This may take some time, please be patient and do not press any buttons on the TV or remote.

Once all available digital and analogue channels have been stored, the TV returns to normal operation, displaying the digital channel stored on channel number 1. If no digital channels are found, the analogue channel stored on channel 1 is displayed.

When a message appears for you to confirm the aerial connections

No digital or analogue channels are found. Check all the aerial connections and press OK to start auto-tuning again.

- 2 When the Programme Sorting menu appears on the screen, follow steps 2 to 3 of “Programme Sorting (Analogue mode only)” (page 29).

If you do not change the order in which the analogue channels are stored on the TV, go to step 3.

- 3 Press MENU to exit.

The TV has now tuned in all the available channels.

Watching TV

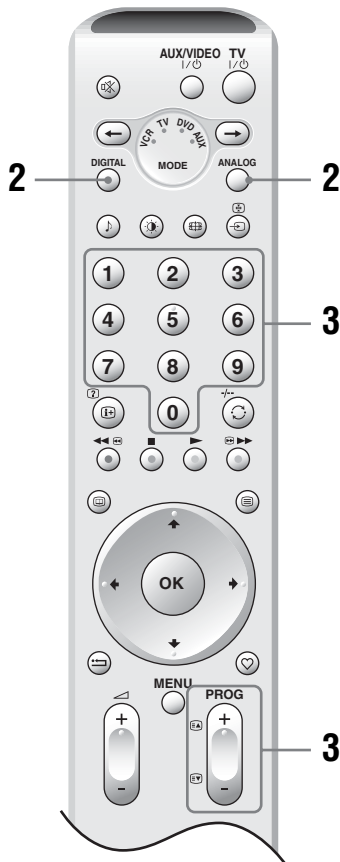
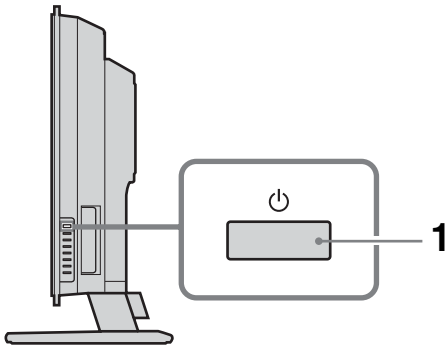

1 Press on the TV (right side) to switch on the TV.

When the TV is in standby mode (the (standby) indicator on the TV (front) is red), press TV on the remote to switch on the TV.

2 Press DIGITAL to switch to digital mode or ANALOG to switch to analogue mode.

The channels available vary depending on the mode.

3 Press the number buttons or PROG +/- to select a TV channel.

To select channel numbers 10 and above using the number buttons, enter the second and third digits within two seconds.

To select a digital channel using the Digital Electronic Programme Guide (EPG), see page 16.



In digital mode

An information banner appears briefly. The following icons may be indicated on the banner.

- : Interactive service is available (MHEG Digital Text)
- : Interactive service (MHEG Digital Text) is currently disabled
- : Radio service
- : Scrambled/Subscription service
- : Multiple audio languages available
- : Subtitles available
- : Subtitles available for the hearing impaired
- : Recommended minimum age for current programme (from 4 to 18 years)
- : Parental Lock
- : Current programme is being recorded

Additional operations

To	Do this
Turn off the TV temporarily (Standby mode)	Press TV .
Turn off the TV completely	Press on the TV (right side).
Adjust the volume	Press + (increase) /- (decrease).
Mute the sound	Press . Press again to restore.
Switch to digital mode	Press DIGITAL.
Hide interactive prompts from the screen (in digital mode only)	
Switch to analogue mode	Press ANALOG.

To	Do this
Return to the previous channel watched (for more than five seconds)	Press  .
Access the Programme index table (in analogue mode only)	Press OK. To select an analogue channel, press  , then press OK. To access the Input signal index table, see page 19.

To access Digital Text

Many broadcasters provide a Digital Text service. Digital Text offers graphically rich contents, compared to Analogue Text.

Select a digital channel which provides Digital Text, then press .

When a broadcaster provides a dedicated Digital Text channel, select this channel to access Digital Text. To navigate through Digital Text, follow the instructions on the screen.



To exit Digital Text, press .

To move around, press .

To select items, press OK and the number buttons.



To access shortcuts, press the coloured buttons.



To access Analogue Text

In analogue mode, press . Each time you press , the display changes cyclically as follows:

Text → Text over the TV picture (mix mode) → No Text (exit the Text service)

To select a page, press the number buttons or PROG +/-.

To hold a page, press / .

To reveal hidden information, press / .

Tips

- Ensure that the TV is receiving a good signal, or some text errors may occur.
- Most TV channels broadcast a Text service. For information on the use of the service, select the index page (usually page 100).
- When four coloured items appear at the bottom of the Text page, Fastext is available. Fastext allows you to access pages quickly and easily. Press the corresponding coloured button to access the page.

To change the screen mode manually to suit the broadcast

Press  repeatedly to select Wide, Smart, 4:3, 14:9, or Zoom.

Wide

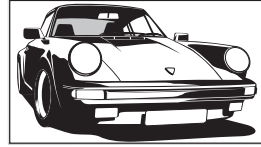

Displays wide screen (16:9) broadcasts in the correct proportions.

Smart*

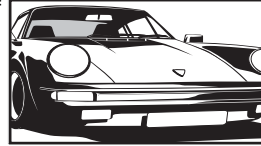

Displays conventional 4:3 broadcasts with an imitation wide screen effect. The 4:3 picture is stretched to fill the screen.

4:3

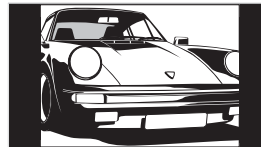

Displays conventional 4:3 broadcasts (e.g., non-wide screen TV) in the correct proportions.

14:9*

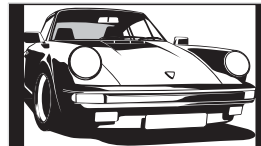

Displays 14:9 broadcasts in the correct proportions. As a result, black border areas are visible on the screen.

Zoom*

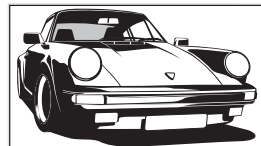

Displays cinemascopic (letter box format) broadcasts in the correct proportions.

* Parts of the top and bottom of the picture may be cut off.

Tips

- Alternatively, you can set “Auto Format” to “On”. The TV will automatically select the best mode to suit the broadcast (page 25).
- You can adjust the portion of the picture when selecting Smart, 14:9, or Zoom. Press  to move up or down (e.g., to read subtitles).

Checking the Digital Electronic Programme Guide (EPG) DV3

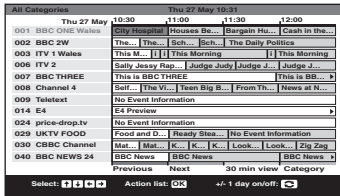

Digital Electronic Programme Guide (EPG)

- 1 In digital mode, press to display the Digital Electronic Programme Guide (EPG).
- 2 Perform the desired operation, as shown in the following table.

To	Do this
Turn off the EPG	Press .
Move through the EPG	Press .
Display the previous or next six channels	Press the red (previous) or green (next) button.
Watch a current programme	Press OK while the current programme is selected.
Sort the programme information by category – Category list	<ol style="list-style-type: none"> 1 Press the blue button. 2 Press to select a category. The category name is displayed on the side. The categories available include: Favourite Contains all the channels that have been stored in the Favourite list (page 18). All Categories Contains all available channels. News Contains all news channels. 3 Press OK. The Digital Electronic Programme Guide (EPG) now only displays the current programmes from the category selected.
Set a programme to be recorded – Timer REC	<ol style="list-style-type: none"> 1 Press to select the future programme you want to record. 2 Press OK. 3 Press to select “Timer REC”. 4 Press OK to set the TV and your VCR timers. A symbol appears by that programme’s information. The indicator on the TV (front) lights up. <p>Notes</p> <ul style="list-style-type: none"> • You can set VCR timer recording on the TV only for Smartlink compatible VCRs. If your VCR is not Smartlink compatible, a message will be displayed to remind you to set your VCR timer. • Once a recording has begun, you can switch the TV to standby mode, but do not switch off the TV completely or the recording may be cancelled.

To	Do this
Set a programme to be displayed automatically on the screen when it starts – Reminder	<ol style="list-style-type: none"> 1 Press ↑/↓/←/→ to select the future programme you want to display. 2 Press OK. 3 Press ↑/↓ to select “Reminder”. 4 Press OK to automatically display the selected programme when the programme starts. A ⌚ symbol appears by that programme’s information. <p>Note If you switch the TV to standby mode, it will automatically turn itself on when the programme is about to start.</p>
Set the time and date of a programme you want to record – Manual timer REC	<ol style="list-style-type: none"> 1 Press OK. 2 Press ↑/↓ to select “Manual timer REC”. 3 Press ↑/↓ to select the date, then press →. 4 Set the start and stop time in the same way as in step 3. 5 Press ↑/↓ to select the channel, then press OK to set the TV and your VCR timers. A 📺 symbol appears by that programme’s information. The ⌚ indicator on the TV (front) lights up. <p>Notes</p> <ul style="list-style-type: none"> • You can set VCR timer recording on the TV only for Smartlink compatible VCRs. If your VCR is not Smartlink compatible, a message will be displayed to remind you to set your VCR timer. • Once a recording has begun, you can switch the TV to standby mode, but do not switch off the TV completely or the recording may be cancelled.
Cancel a recording/reminder – Timer list	<ol style="list-style-type: none"> 1 Press OK. 2 Press ↑/↓ to select “Timer list”. 3 Press ↑/↓ to select the programme you want to cancel, then press OK. A display appears to confirm that you want to cancel the programme. 4 Press → to select “Yes”, then press OK to confirm.

Using the Favourite list DV3

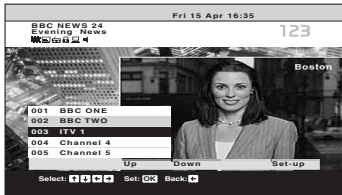

Favourite list

- 1 In digital mode, press ♥ to display the Favourite list.
A message appears asking if you want to add channels to the Favourite list when the Favourite list is blank.
- 2 Perform the desired operation, as shown in the following table.

To	Do this
Create your Favourite list for the first time	<p>A message appears asking if you want to add channels to the Favourite list when you press ♥ for the first time.</p> <ol style="list-style-type: none"> 1 Press OK to select “Yes”. 2 Press ↑/↓ to select the channel you want to add, then press OK. If there are more than five channels in the list, press the green button for the next five channels or press the red button for the previous five channels. If you know the channel number, you can use the number buttons to directly select a channel. 3 Press OK. Channels that are stored in the Favourite list are indicated by a ♥ symbol.
Turn off the Favourite list	Press ♥.
Move through in the Favourite list	Press ↑/↓.
Display the previous or next five channels	Press the red (previous) or green (next) button.
See brief details on current programmes	Press ⊕ while selecting a channel. Press again to cancel.
Watch a channel	Press OK while selecting a channel.
Add or remove channels in the Favourite list	<ol style="list-style-type: none"> 1 Press the blue button. Channels that are stored in the Favourite list are indicated by a ♥ symbol. 2 Press ↑/↓ to select the channel you want to add or remove. If there are more than five channels in the list, press the green button for the next five channels or press the red button for the previous five channels. If you know the channel number, you can use the number buttons to directly select a channel. 3 Press OK. 4 Press the blue button to return to the Favourite list.
Remove all channels from the Favourite list	<ol style="list-style-type: none"> 1 Press the blue button. 2 Press the yellow button. A display appears to confirm that you want to delete all channels from the Favourite list. 3 Press ← to select “Yes”, then press OK to confirm.

Viewing pictures from connected equipment

Switch on the connected equipment, then perform one of the following operation.

For equipment connected to the scart sockets using a fully-wired 21-pin scart lead

Start playback on the connected equipment. The picture from the connected equipment appears on the screen.

For an auto-tuned VCR (page 11)

In analogue mode, press PROG +/-, or the number buttons, to select the video channel.

For other connected equipment

Press repeatedly until the correct input symbol (see below) appears on the screen.

1/2, 2/3, 3/4:
Audio/video or RGB input signal through the scart socket 1, 2 or 3. 4 appears only if an RGB source has been connected.

4:
Component input signal through the Y, PB/CB, PR/Cr sockets 4, and audio input signal through the L/G/S/I, R/D/D/D sockets 4.

5:
Digital audio/video signal is input through the HDMI IN 5 socket. Audio input signal is analogue only if the equipment has been connected using the DVI and audio out socket.

6/S/6:
Video input signal through the video socket 6, and audio input signal through the audio socket L/G/S/I (MONO), R/D/D/D sockets 6. S appears only if the equipment is connected to the S video socket S instead of the video socket 6, and S video input signal is input through the S video socket S.

Additional operations

To	Do this
Return to the normal TV operation	Press DIGITAL or ANALOG.
Access the Input signal index table	Press OK to access the Input signal index table. (Then, only in analogue mode, press .) To select an input source, press , then press OK.

Using the Menu

Navigating through menus

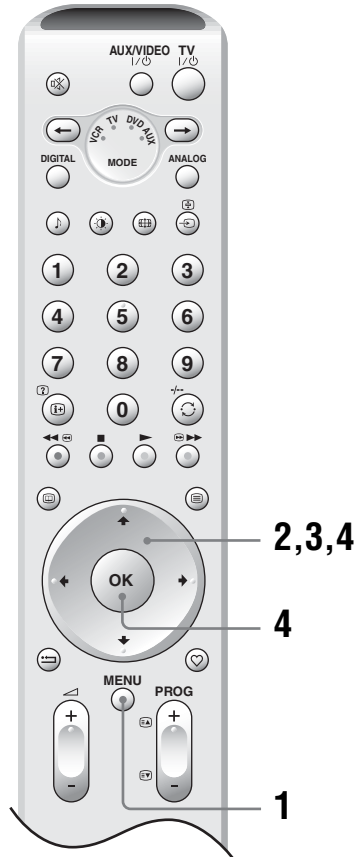

- 1 Press MENU to display the menu.
- 2 Press to select a menu icon.
- 3 Press to select an option.
- 4 Press to change/set the setting, then press OK.
To exit the menu, press MENU.
To return to the last display, press .

Continued

Overview of the menus

The following options are available in each menu. For details on navigating through menus, see page 19. Also, see page in parentheses for details of each menu.

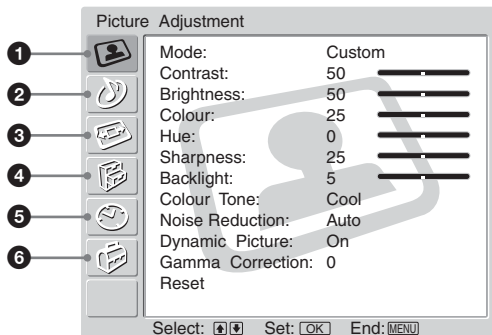

1 Picture Adjustment

- Mode (21)
- Contrast/Brightness/Colour/Hue/Sharpness/Backlight (21)
- Colour Tone (21)
- Noise Reduction (22)
- Dynamic Picture (22)
- Gamma Correction (22)
- Reset (22)

2 Sound Adjustment

- Effect (23)
- Treble/Bass/Balance (23)
- Auto Volume (23)
- Dual Sound (24)
- Woofer Level (24)
- Volume (24)
- Dual Sound (24)
- Reset (24)

3 Screen Control

- Auto Format (25)
- Screen Format (25)
- Screen Shift (25)
 - V Shift/H Shift/Reset

4 Features

- Power Saving (26)
- Speaker (26)
- AV2 Output (26)
- Picture Off (27)
- Logo Illumination (27)

5 Timer

- Sleep Timer (28)
- Auto Shutoff (28)

6 Set Up

- Auto Start Up (29)
- Auto Tuning (29)
- Programme Sorting (29)
- Programme Labels (30)
 - Equipment labels/Edit/Skip
- Manual Programme Preset (30)
 - Programme/Channel/Label/AFT/Audio Filter/Skip/ATT/Confirm
- Digital Set Up (32)
 - Digital Tuning/Digital Set-up

Note

The options you can adjust vary depending on the situation. Only the options that can be operated are displayed.

Picture Adjustment menu

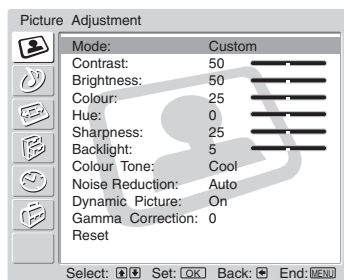

You can select the options listed below on the Picture Adjustment menu. To select options, see “Navigating through menus” (page 19).

Tip

When you set “Mode” to “Vivid” or “Standard”, you can adjust only “Mode”, “Contrast”, “Colour Tone”, “Noise Reduction”, and “Reset”.

Mode

Selects the picture mode.

- 1 Press OK to select “Mode”.
- 2 Press **↑/↓** to select one of the following picture modes, then press OK.
Vivid: For enhanced picture contrast and sharpness.
Standard: For standard picture. Recommended for home entertainment.
Custom: Allows you to store your preferred settings.

Tip

You can also change the picture mode by pressing **⊙** repeatedly.

Contrast/Brightness/Colour/Hue/Sharpness/Backlight

- 1 Press OK to select the option.
- 2 Press **←/→** to set the level, then press OK.

Tip

“Hue” can only be adjusted for an NTSC colour signal (e.g., U.S.A. video tapes).

Colour Tone

- 1 Press OK to select “Colour Tone”.
- 2 Press **↑/↓** to select one of the following, then press OK.
Cool: Gives the white colours a blue tint.
Neutral: Gives the white colours a neutral tint.
Warm: Gives the white colours a red tint.

Noise Reduction

Reduces the picture noise (snowy picture) in a weak broadcast signal.

- 1 Press OK to select “Noise Reduction”.
- 2 Press **↑/↓** to select one of the following, then press OK.

Auto: Automatically reduces the picture noise.

High/Low/Off: Modifies the effect of the noise reduction.

CNR: Reduces the picture noise when the animation image is received.

BNR: Reduces the block picture noise. This is effective for digital channels, or a connected DVD player/digital satellite receiver with MPEG playback.

Dynamic Picture

Enhances the picture contrast.

- 1 Press OK to select “Dynamic Picture”.
- 2 Press **↑/↓** to select “On”, then press OK.

Gamma Correction

Adjusts the balance between bright and dark areas of the picture.

- 1 Press OK to select “Gamma Correction”.
- 2 Press **↑/↓** to set the level, then press OK.

Reset

Reset all the picture settings to the factory settings.

- 1 Press OK to select “Reset”.
- 2 Press **↑/↓** to select “OK”, then press OK.

Sound Adjustment menu

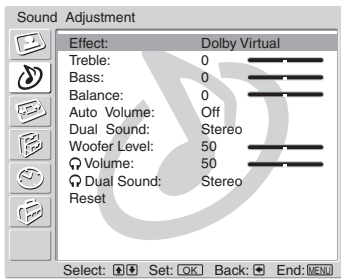

You can select the options listed below on the Sound Adjustment menu. To select options, see “Navigating through menus” (page 19).

Effect (sound effect)

- 1 Press OK to select “Effect”.
- 2 Press **↑/↓** to select one of the following sound effects, then press OK.
Off: Flat response.
Natural: Enhances clarity, detail, and sound presence by using “BBE High Definition Sound System”^{*1}.
Dynamic: Intensifies clarity and sound presence for better intelligibility and musical realism by using the “BBE High Definition Sound System”.
Dolby Virtual^{*2}: Uses the TV speakers to simulate the surround effect produced by a multi channel system.

Tips

- You can also change sound effect by pressing **♪** repeatedly.
- If you set “Auto Volume” to “On”, “Dolby Virtual” is automatically set to “Natural”.

^{*1} Manufactured under license from BBE Sound, Inc.

Licensed by BBE Sound, Inc. under USP4638258, 4482866. “BBE” and BBE symbol are trademarks of BBE Sound, Inc.

^{*2} Manufactured under licence from Dolby Laboratories. “Dolby” and the double-D **DD** are trademarks of Dolby Laboratories.

Treble/Bass/Balance

Adjusts higher-pitched sounds (Treble), adjusts lower-pitched sounds (Bass), and emphasizes left or right speaker balance (Balance).

- 1 Press OK to select the option.
- 2 Press **←/→** to set the level, then press OK.

Auto Volume

Keeps a constant volume level even when volume level gaps occur (e.g., adverts tend to be louder than programmes).

- 1 Press OK to select “Auto Volume”.
- 2 Press **↑/↓** to select “On”, then press OK.

Tip

If you set “Effect” to “Dolby Virtual”, “Auto Volume” will automatically be switched to “Off”.

Continued

Dual Sound

Selects the sound from the speaker for a stereo or bilingual broadcast.

- 1 Press OK to select “Dual Sound”.
- 2 Press **↑/↓** to select one of the following, then press OK.

Stereo, Mono: For a stereo broadcast.

A/B/Mono: For a bilingual broadcast, select “A” for sound channel 1, “B” for sound channel 2, or “Mono” for a mono channel, if available.

Tip

If you select other equipment connected to the TV, set “Dual Sound” to “Stereo”, “A” or “B”.

Woofer Level

Adjusts the output level of the built-in woofer of the TV.

- 1 Press OK to select “Woofer Level”.
- 2 Press **←/→** to set the level, then press OK.

Volume (headphone volume)

Adjusts the volume of the headphones.

- 1 Press OK to select “ Volume”.
- 2 Press **←/→** to set the level, then press OK.

Dual Sound

Selects the sound of the headphones for a stereo or bilingual broadcast.

- 1 Press OK to select “ Dual Sound”.
- 2 Press **↑/↓** to select one of the following, then press OK.

Stereo, Mono: For a stereo broadcast.

A/B/Mono: For a bilingual broadcast, select “A” for sound channel 1, “B” for sound channel 2, or “Mono” for a mono channel, if available.

Tip

If you select other equipment connected to the TV, set “ Dual Sound” to “Stereo”, “A” or “B”.

Reset

Resets the “Treble”, “Bass” and “Balance” settings to the factory settings.

- 1 Press OK to select “Reset”.
- 2 Press **↑/↓** to select “OK”, then press OK.

Screen Control menu

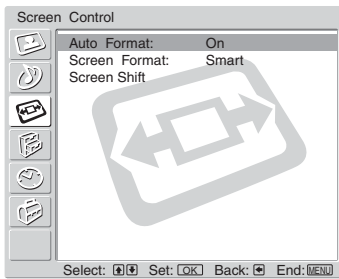

You can select the options listed below on the Screen Control menu. To select options, see “Navigating through menus” (page 19).

Auto Format

Automatically changes the screen format according to the broadcast signal.

- 1 Press OK to select “Auto Format”.
- 2 Press **↑/↓** to select “On”, then press OK.
To keep your setting, select “Off”.

Tips

- Even if you have selected “On” or “Off” in “Auto Format”, you can always modify the format of the screen by pressing **⏏** repeatedly.
- “Auto Format” is available for PAL and SECAM signals only.

Screen Format

For details about the screen format, see page 15.

- 1 Press OK to select “Screen Format”.
- 2 Press **↑/↓** to select “Smart”, “4:3”, “14:9”, “Zoom” or “Wide” (see page 15 for details), then press OK.

Screen Shift

Adjusts the position of the picture for each screen format.

- 1 Press OK to select “Screen Shift”.
- 2 Press **↑/↓** to select one of the following, then press OK.
V Shift: Adjusts the vertical picture position.
H Shift: Adjusts the horizontal picture position.
Reset: Resets to the factory settings. Instead of step 3, press **↑/↓** to select “OK”, then press OK.
- 3 Press **↑/↓** (for vertical picture position) or **←/→** (for horizontal picture position), then press OK.

Tip

When “Screen Format” is set to “4:3” or “Wide”, “V Shift” cannot be adjusted.

Features menu

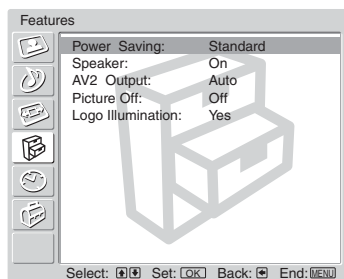

You can select the options listed below on the Features menu. To select options, see “Navigating through menus” (page 19).

Power Saving

Reduces the power consumption of the TV.

- 1 Press OK to select “Power Saving”.
- 2 Press **↑/↓** to select “Reduce”, then press OK.

Speaker



Switches on/off the TV’s internal speakers.

- 1 Press OK to select “Speaker”.
- 2 Press **↑/↓** to select “On” or “Off”, then press OK.

On: The sound of the TV is output through the TV’s speakers.

Off: The sound of the TV is output through the external audio equipment connected to the audio output sockets .

AV2 Output

Sets a signal to be output through the socket labelled 2 on the rear of the TV. If you connect a VCR or other recording equipment to the 2 socket, you can then record from the equipment connected to other sockets of the TV.

- 1 Press OK to select “AV2 Output”.
- 2 Press **↑/↓** to select one of the following, then press OK.



Auto: Outputs whatever is being viewed on the screen.

TV Analog: Outputs an analogue broadcast.

TV Digital: Outputs a digital broadcast.

AV1: Outputs signals from equipment connected to the 1 socket.

AV3: Outputs signals from equipment connected to the 3 socket.

AV6: Outputs signals from equipment connected to the 6/S-6 socket.

Picture Off

Switches off the picture. You can still listen to the sound with the picture off.

- 1 Press OK to select “Picture Off”.
- 2 Press **↑/↓** to select “On,” then press OK.

The  (Picture Off) indicator on the TV (front) lights up in green. To restore the picture, press any buttons (except **↵** +/- and **♪**).

Logo Illumination

Illuminates the SONY logo on the TV (front).

- 1 Press OK to select “Logo Illumination”.
- 2 Press **↑/↓** to select “Yes”, then press OK.

Timer menu

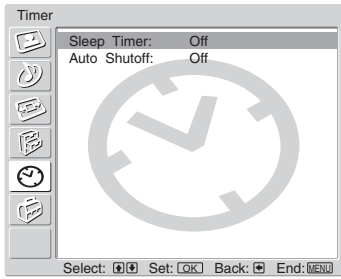

You can select the options listed below on the Timer menu. To select options, see “Navigating through menus” (page 19).

Sleep Timer

Sets a period of time after which the TV automatically switches itself into standby mode.

- 1 Press OK to select “Sleep Timer”.
- 2 Press **↑/↓** to select the desired time period (“30min”/“60min”/“90min”/“120min”), then press OK.

The **⌚** (Timer) indicator on the TV (front) lights up in orange.

Tips

- If you switch off the TV and switch it on again, “Sleep Timer” is reset to “Off”.
- “Sleep timer will end soon. Power will be turned off.” appears on the screen one minute before the TV switches to standby mode.
- If you press **⊕/?**, the remaining time in minutes before the TV switches to standby mode is displayed on the screen.

Auto Shutoff

Sets the TV to switch to standby mode automatically when you select the input source and there is no input signal from connected equipment.

In TV mode, this Auto Shutoff function is always set to “On”.

- 1 Press OK to select “Auto Shutoff”.
- 2 Press **↑/↓** to select “On”, then press OK.

Set Up menu

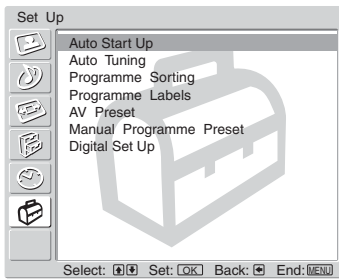

You can select the options listed below on the Set Up menu. To select options, see “Navigating through menus” (page 19).

Auto Start Up

Starts the “first time operation menu” to tune in all available digital and analogue channels. Usually, you do not need to do this operation because the channels will have been already tuned when the TV was first installed (page 13). However, this option allows you to repeat the process (e.g., to retune the TV after moving house, or to search for new channels that have been launched by broadcasters).

- 1 Press OK to select “Auto Start Up”.
- 2 Press OK to select “Yes”.
The auto-tune display appears on the screen.
- 3 Follow steps 1 to 3 of “6: Auto-tuning the TV” (page 13).

Auto Tuning (Analogue mode only)

Tunes in all the available analogue channels.

Usually you do not need to do this operation because the channels are already tuned when the TV was first installed (page 13). However, this option allows you to repeat the process (e.g., to retune the TV after moving house, or to search for new channels that have been launched by broadcasters).

- 1 Press OK to select “Auto Tuning”.
- 2 Follow step 1 of “6: Auto-tuning the TV” (page 13).
When all available analogue channels have been tuned, the TV returns to normal operation.

Programme Sorting (Analogue mode only)

Changes the order in which the analogue channels are stored on the TV.

- 1 Press OK to select “Programme Sorting”.
- 2 Press **↑/↓** to select the channel you want to move to a new position, then press OK.
- 3 Press **↑/↓** to select the new position for your channel, then press OK.
Repeat the procedure in steps 2 and 3 to move other channels if required.

Continued

Programme Labels (Analogue mode only)

Assigns a channel name of your choice up to five letters or numbers. The name will be displayed briefly on the screen when the channel is selected. (Names for channels are usually taken automatically from Analogue Text (if available).)

- 1 Press OK to select “Programme Labels”.
- 2 Press **↑/↓** to select the channel you want to name, then press OK.
- 3 Press **↑/↓/←/→** to select the desired letter or number (“□” for a blank space), then press OK.

If you input a wrong character

Press **↑/↓/←/→** to select  and press OK repeatedly until the wrong character is selected. Then, press **↑/↓/←/→** to select the correct character and press OK.

- 4 Repeat the procedure in step 3 until the name is complete.
- 5 Press **↑/↓/←/→** to select “End”, then press OK.

AV Preset

Assigns a name to any equipment connected to the side and rear sockets. The name will be displayed briefly on the screen when the equipment is selected. You can skip an input source that is not connected to any equipment.

- 1 Press OK to select “AV Preset”.
- 2 Press **↑/↓** to select the desired input source, then press OK.
- 3 Press **↑/↓** to select the desired option below, then press OK.

Option	Description
Equipment labels	Uses one of the preset labels to assign a name to connected equipment.
Edit	Creates your own label. Follow steps 3 to 5 of “Programme Labels” (page 30).
Skip	Skips an input source that is not connected to any equipment when you press ↑/↓ to select the input source.

Manual Programme Preset (Analogue mode only)

Before selecting “Label”/“AFT”/“Audio Filter”/“Skip”/“ATT”, press PROG +/- to select the programme number with the channel. You cannot select a programme number that is set to skip (page 32).

- 1 Press OK to select “Manual Programme Preset”.
- 2 Press **↑/↓** to select one of the following options, then press OK.

Option	Description
Programme Channel	<p>Presets programme channels manually.</p> <ol style="list-style-type: none"> 1 Press ↑/↓ to select “Programme”, then press OK. 2 Press ↑/↓ to select the programme number you want to manually tune (if tuning a VCR, select channel 0), then press ←. 3 Press ↑/↓ to select “Channel”, then press OK. 4 Press →. 5 Tune the channels as follows: <ul style="list-style-type: none"> If you do not know the channel number (frequency) Press ↑/↓ to search for the next available channel. When a channel has been found, the search will stop. To continue searching, press ↑/↓. If you know the channel number (frequency) Press the number buttons to enter the channel number of the broadcast you want or your VCR channel number. 6 Press OK. 7 Press ↓ to select “Confirm”, then press OK. 8 Press ↓ to select “OK”, then press OK. <p>Repeat the procedure above to preset other channels manually.</p>
Label	<p>Assigns a name of your choice, up to five letters or numbers, to the selected channel. This name will be displayed briefly on the screen when the channel is selected.</p> <ol style="list-style-type: none"> 1 Follow steps 3 to 5 of “Programme Labels” (page 30). 2 Press ↓ to select “Confirm”, then press OK. 3 Press ↓ to select “OK”, then press OK.
AFT	<p>Fine-tunes the selected programme number manually if you feel that a slight tuning adjustment will improve the picture quality. (Normally, fine tuning is performed automatically.)</p> <ol style="list-style-type: none"> 1 Press ↑/↓ to adjust the fine tuning over a range of -15 to +15, then press OK. 2 Press ↓ to select “Confirm”, then press OK. 3 Press ↓ to select “OK”, then press OK. <p>To restore automatic fine tuning, select “On” in step 1.</p>
Audio Filter	<p>Improves the sound for individual channels in the case of distortion in mono broadcasts. Sometimes a non-standard broadcast signal can cause sound distortion or intermittent sound muting when watching mono programmes.</p> <ol style="list-style-type: none"> 1 Press ↑/↓ to select “Low” or “High”, then press OK. If you do not experience any sound distortion, we recommend that you leave this option set to the factory setting “Off”. 2 Press ↓ to select “Confirm”, then press OK. 3 Press ↓ to select “OK”, then press OK. <p>Note You cannot receive stereo or dual sound when “Low” or “High” is selected.</p>

Continued

Option	Description
Skip	<p>Skips unused analogue channels when you press PROG +/- to select channels. (You can still select a skipped channel using the number buttons.)</p> <ol style="list-style-type: none"> 1 Press ↑/↓ to select “Yes”, then press OK. 2 Press ↓ to select “Confirm”, then press OK. 3 Press ↓ to select “OK”, then press OK. <p>To restore a skipped channel, select “No” in step 1.</p>
ATT	<p>Attenuates the RF signal. In case of a strong RF signal, some video interference may be displayed.</p> <ol style="list-style-type: none"> 1 Press ↑/↓ to select “On”, then press OK. 2 Press ↓ to select “Confirm”, then press OK. 3 Press ↓ to select “OK”, then press OK. <p>Note When “ATT” is set to “On”, picture noise may occur during VCR recording when turning on/off the TV or selecting a TV channel. In this case, connect your aerial to the input socket on your VCR, then connect the output socket on your VCR to the  socket on the rear of the TV. Confirm that the VCR can record the digital channels.</p>

Digital Set Up

Displays the “Digital Set Up” menu. You can change/set the digital settings using this menu.

- 1 Press OK to select “Digital Set Up”.
- 2 Press **↑/↓** to select the desired icon below, then press OK.

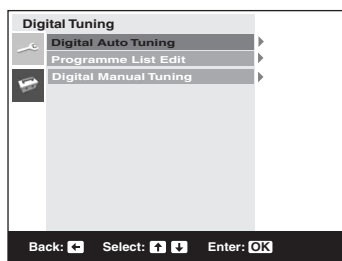

Digital Tuning menu

- 3 Press **↑/↓** to select one of the following options, then press OK.

Option	Description
Digital Tuning	Tunes in all the available digital channels.
Digital Auto Tuning	<p>Usually you do not need to do this operation because the channels are already tuned when the TV was first installed (page 13). However, this option allows you to repeat the process (e.g., to retune the TV after moving house, or to search for new channels that have been launched by broadcasters).</p> <ol style="list-style-type: none"> 1 Press OK to start digital auto-tuning. When all available digital channels have been tuned, a message stating that the auto-tuning process is finished appears. 2 Press ←.

Option	Description
Programme List Edit	<p>Removes any unwanted digital channels stored on the TV, and changes the order of the digital channels stored on the TV.</p> <ol style="list-style-type: none"> Press ↑/↓ to select the channel you want to remove or move to a new position. <ul style="list-style-type: none"> If you know the channel number (frequency) Press the number buttons to enter the three-digit programme number of the broadcast you want. To display the previous or next five channels Press the red button (previous) or the green button (next). Remove or change the order of the digital channels as follows: <ul style="list-style-type: none"> To remove the digital channel Press OK. A message that confirms whether the selected digital channel is to be deleted appears. Press → to select “Yes”, then press OK. To change the order of the digital channels Press →, then press ↑/↓ to select the new position for the channel and press OK. Repeat the procedure in steps 1 and 2 to move other channels if required. Press ←.
Digital Manual Tuning	<p>Tunes the digital channels manually.</p> <ol style="list-style-type: none"> Press the number button to select the channel number you want to manually tune, then press ↑/↓ to tune the channel. When the available channels are found, press ↑/↓ to select the channel you want to store, then press OK. <ul style="list-style-type: none"> To display the previous or next five channels Press the red button (previous) or the green button (next). Press ↑/↓ to select the programme number where you want to store the new channel, then press OK. Repeat the procedure above to tune other channels manually.
Digital Set-up	Displays digital subtitles on the screen.
Subtitle Setting	<p>Press ↑/↓ to select “Off”, “Basic”, or “For Hard Of Hearing”, then press OK.</p> <p>When “For Hard Of Hearing” is selected, some visual aids may also be displayed with the subtitles (if TV channels broadcast such information).</p>
Subtitle Language	<p>Selects which language subtitles are displayed in.</p> <p>Press ↑/↓ to select the language, then press OK.</p>
Audio Language	<p>Selects the language used for a programme. Some digital channels may broadcast several audio languages for a programme.</p> <p>Press ↑/↓ to select the audio language, then press OK.</p>
Audio Type	<p>Increases the sound level.</p> <p>Press ↑/↓ to select “Basic” or “For Hard Of Hearing”, then press OK.</p>

Continued

Option	Description
Parental Lock	<p>Sets an age restriction for programmes. Any programme that exceeds the age restriction can only be watched after a PIN Code is entered correctly.</p> <ol style="list-style-type: none"> 1 Press the number buttons to enter your existing PIN code. If you have not previously set a PIN, a message appears to inform you. Press OK, then follow the instruction of “PIN Code” below. 2 Press ↑/↓ to select the age restriction or “None” (for unrestricted watching), then press OK. 3 Press ←.
PIN Code	<p>Sets a PIN code for the first time, or to change your PIN code.</p> <ol style="list-style-type: none"> 1 Enter a PIN as follows: If you have previously set a PIN Press the number buttons to enter your existing PIN. If you have not set a PIN: Press the number buttons to enter the factory setting PIN of 9999. 2 Press the number buttons to enter the new PIN code. 3 When requested, press the number buttons to enter the new PIN again for confirmation. A message appears to inform you that the new PIN has been accepted. 4 Press ←. <p>Tip PIN code 9999 is always accepted.</p>
Technical Set-up	<p>Displays the Technical Set-up menu. Do the following options.</p> <ol style="list-style-type: none"> 1 Press ↑/↓ to select the desired option, then press OK. Auto Service Update: Enables the TV to detect and store new digital services as they become available. Software Download: Enables the TV to automatically receive software updates, free through your existing aerial (when issued). Sony recommends that this option is set to “On” at all times. If you do not want your software to be updated, set this option to “Off”. System Information: Displays the current software version and the signal level. Instead of step 2, Press ←. 2 Press ↑/↓ to select the “On”, then press OK.
CA Module Set-up	<p>This option will allow you to access a Pay Per View service once you obtain a Conditional Access Module (CAM) and a view card. See page 35 for the location of the MODEM and  (PCMCIA) sockets.</p>

Connecting optional equipment

You can connect a wide range of optional equipment to your TV. Connecting cables are not supplied.

Connecting to the TV (side)

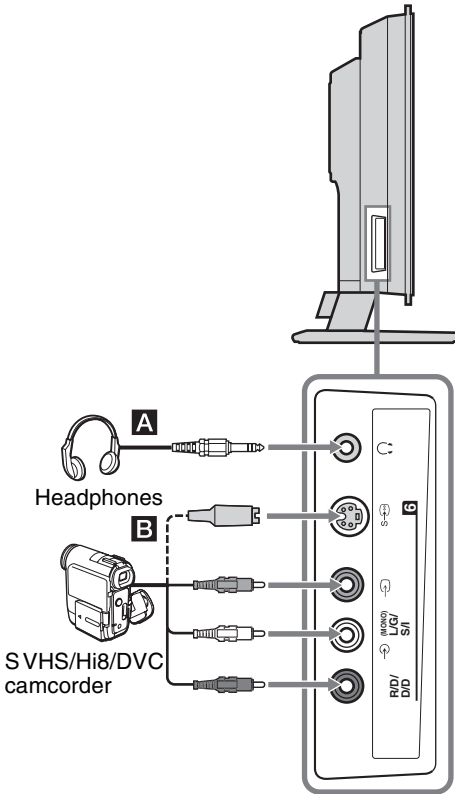

To connect	Do this
Headphones A	Connect to the socket to listen to sound from the TV on headphones.
S VHS/Hi8/DVC camcorder B	Connect to the S video socket 6 or the video socket 6, and the audio sockets 6. To avoid picture noise, do not connect the camcorder to the video socket 6 and the S video socket 6 at the same time. If you connect mono equipment, connect to the L/G/S/I socket 6, and set "Dual Sound" to "A" (page 24).

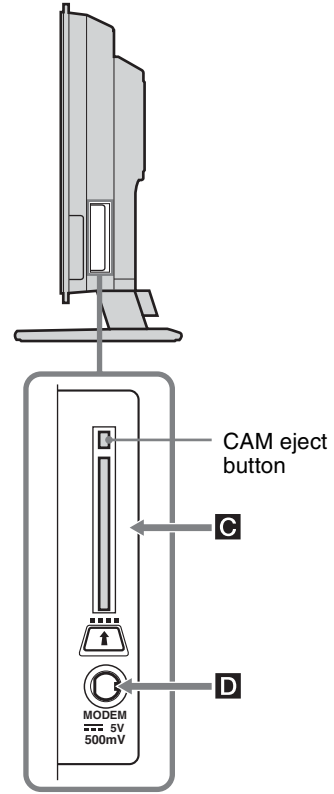

To connect	Do this
Conditional Access Module (CAM) C	To use Pay Per View services. For details, refer to the instruction manual supplied with your CAM. To use the CAM, press the eject button and remove the "dummy" card. Switch off the TV when inserting your CAM into the CAM slot. When you do not use the CAM, we recommend that the "dummy" card be inserted and kept in the CAM slot.
Modem connector D	For future use only.

Continued

Connecting to the TV (rear)

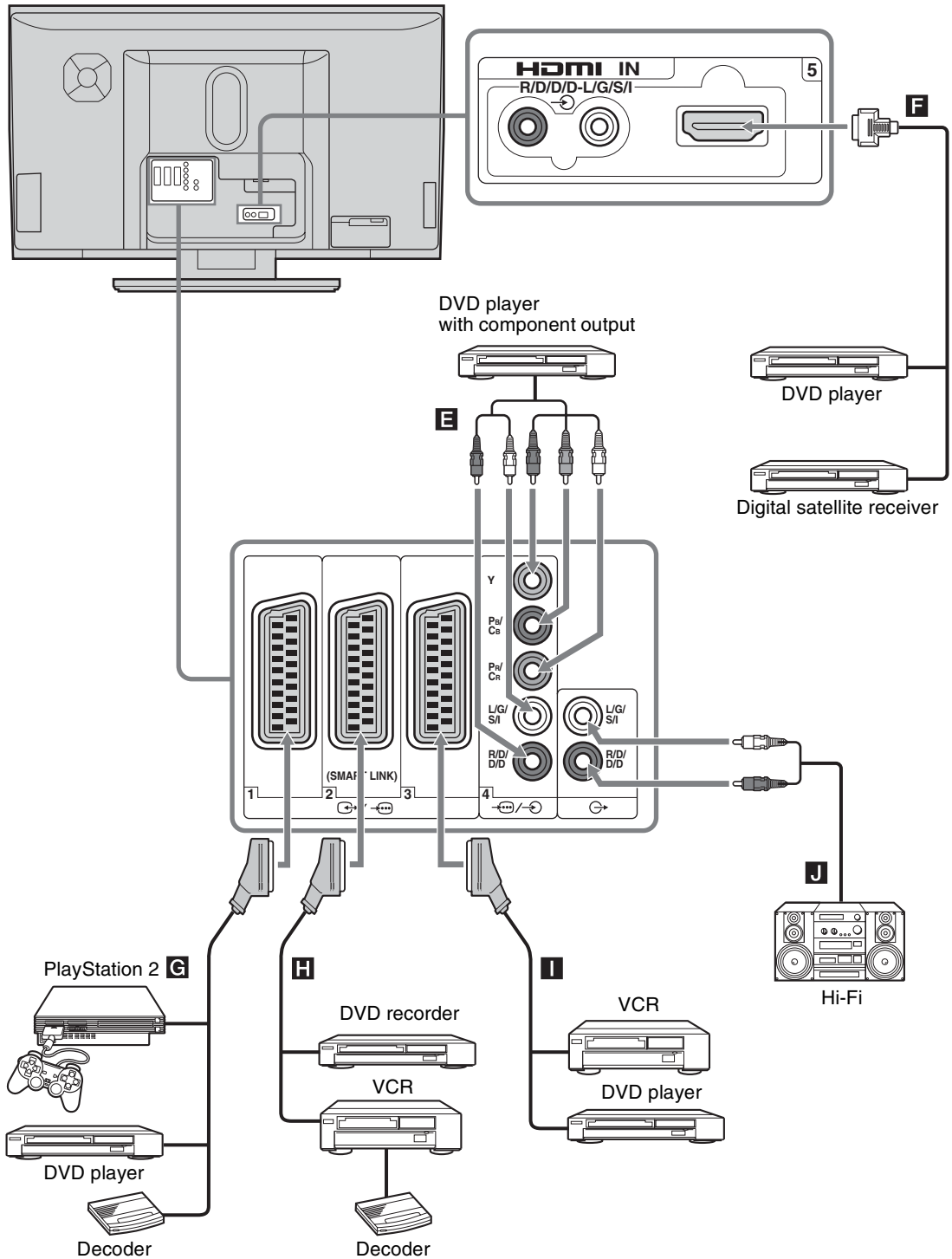

To connect	Do this
DVD player with component output E	Connect to the component sockets and the audio sockets /4. The component signal containing 576p signal format and audio signal are input from the DVD player.
Digital satellite receiver or DVD player F	Connect to the HDMI IN 5 socket if the equipment has a HDMI socket. The digital video and audio signals are input from the digital satellite receiver. If the equipment has a DVI socket but not an HDMI socket, connect the DVI socket to the HDMI IN 5 socket through a DVI - HDMI adaptor interface (not supplied), and connect the equipment's audio out sockets to the audio in HDMI IN 5 sockets. The digital video and analogue audio signals are input from the equipment.
"PlayStation 2", DVD player or decoder G	Connect to the scart socket /1. When you connect the decoder, the scrambled signal from the TV tuner is output to the decoder, then the unscrambled signal is output from the decoder. In this case, it will be properly unscrambled if you set "AV2 Output" to "TV Analog" (page 26).
DVD recorder or VCR that supports SmartLink H	Connect to the scart socket /2. SmartLink is a direct link between the TV and a VCR/DVD recorder. For more information on SmartLink, refer to the instruction manual supplied with your VCR or DVD recorder.
VCR I	For details, see page 11.
Hi-Fi audio equipment J	Connect to the audio output sockets to listen to the sound from the TV on Hi-Fi audio equipment. To turn off the sound of the TV speakers, set "Speaker" to "Off" (page 26).

Programming the remote

This remote is preset to operate Sony TVs, most Sony DVDs, VCRs and AUX systems (DAV, DTT Receiver, Home Theatre, etc.). To control VCRs and DVDs of other manufactures (and some other Sony VCR, DVD and AUX models), do the following procedure to programme the remote.

Note

Before you start, look up the three-digit code for your brand of DVD, VCR or AUX system from the "Manufacturer's codes" on page 38.

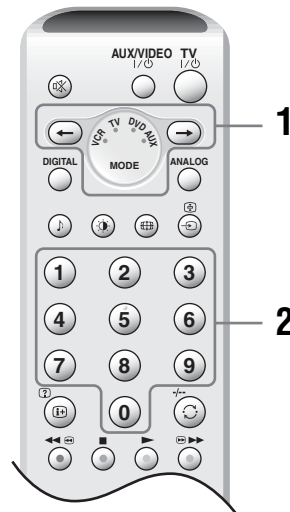

1 To programme VCR or DVD:

Press and hold for about six seconds until the green VCR and DVD lights flash.

To programme Sony AUX systems:

Press and hold for about six seconds until the green AUX light flashes.

2 While the relevant lights are flashing, press the number buttons to enter all three-digits of the code for your brand of equipment (page 38).

The green light is lit momentarily.

3 Turn on your equipment and check that the following main functions work.

(playback), (stop), (rewind), (fast forward), channel selection for both VCR and DVDs, MENU and buttons only for DVDs.

Continued

If your equipment is not working, or some of the functions do not work

Enter the correct code or try the next code listed for the brand. However, not all brands are covered and not all models of every brand may be covered.

Tip

A small label is provided inside the battery door to allow you to record your brand codes.

Manufacturer's codes

Not all brands are covered and not all models of every brand may be covered.

VCR brand list

Brand	Code
SONY (VHS)	301, 302, 303, 308, 309, 362
SONY (BETA)	303, 307, 310
SONY (DV)	304, 305, 306
AIWA	325, 331, 351
AKAI	326, 329, 330
DAEWOO	342, 343
GRUNDIG	358, 355, 360, 361, 320, 351, 366
HITACHI	327, 333, 334
JVC	314, 315, 322, 344, 352, 353, 354, 348, 349
LG	332, 338
LOEWE	358, 355, 360, 361, 320, 351
MATSUI	356, 357
ORION	328
PANASONIC	321, 323
PHILIPS	311, 312, 313, 316, 317, 318, 358, 359, 363, 364
SAMSUNG	339, 340, 341, 345
SANYO	335, 336
SHARP	324
THOMSON	319, 350, 365
TOSHIBA	337

DVD brand list

Brand	Code
SONY	001, 029, 030, 036, 037, 038, 039, 040, 041, 042, 043, 044, 053, 054, 055
AIWA	021
AKAI	032

Brand	Code
DENON	018, 027, 020, 002
GRUNDIG	009, 028, 023, 024, 016, 003
HITACHI	025, 026, 015, 004, 035
JVC	006, 017
KENWOOD	008
LG	015, 014, 034
LOEWE	009, 028, 023, 024, 016, 003
MATSUI	013, 016
ONKYO	022, 033
PANASONIC	018, 027, 020, 002, 045, 046, 047
PHILIPS	009, 028, 023, 024, 016, 003, 031
PIONEER	004, 050, 051, 052
SAMSUNG	011, 014
SANYO	007
SHARP	019, 027
THOMSON	012
TOSHIBA	003, 048, 049
YAMAHA	018, 027, 020, 002

AUX Sony systems brand list

DVD Home Theatre System

Brand	Code
SONY (DAV)	500, 501, 502

Home Theatre System

Brand	Code
SONY	504, 505

AV receiver

Brand	Code
SONY	505, 506, 507, 508

Digital terrestrial receiver

Brand	Code
SONY	503

Specifications

Display Unit

Power Requirements:

220–240 V AC, 50 Hz

Screen Size:

40 inches

Approx. 101.5 cm measured diagonally

Display Resolution:

1,366 dots (horizontal) × 768 lines (vertical)

Power Consumption:

228 W

Standby Power Consumption:

0.5 W or less

Dimensions (w × h × d):

Approx. 1,114.0 × 729.0 × 360.0 mm (with stand)

Approx. 1,114.0 × 647.0 × 114.5 mm (without stand)

Mass:

Approx. 45.0 kg (with stand)

Approx. 29.5 kg (without stand)

Panel System

LCD (Liquid Crystal Display) Panel

TV System

I

Colour System

PAL, SECAM

NTSC 3.58, 4.43 (only Video In)

MPEG-2 MP@ML

Aerial

75 ohm external terminal for VHF/UHF

Channel Coverage

I: UHF B21–B69

Terminals

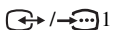
 1

21-pin Scart connector (CENELEC standard) including audio/video input, RGB input, and TV audio/video output.

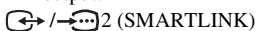
 2 (SMARTLINK)

21-pin Scart connector (CENELEC standard) including audio/video input, RGB input, selectable audio/video output, and SmartLink interface.

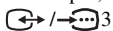
 3

21-pin Scart connector (CENELEC standard) including audio/video input, RGB input, and audio/video output which currently appears on the screen.

 4

Supported formats: 1080i, 720p, 576p, 576i, 480p, 480i

Y: 1 Vp-p, 75 ohms, 0.3V negative sync

P_B/C_B: 0.7 Vp-p, 75 ohms

P_R/C_R: 0.7 Vp-p, 75 ohms

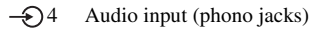
 4 Audio input (phono jacks)

500 mVrms

Impedance: 47 kilo ohms

HDMI IN 5

Video: 1080i, 720p, 576p, 576i, 480p, 480i

Audio: Two channel linear PCM

32, 44.1 and 48kHz, 16,20 and 24 bits,

or analogue audio input (phono jacks)

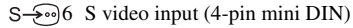
 6 S video input (4-pin mini DIN)

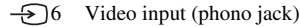
 6 Video input (phono jack)

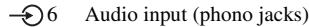
 6 Audio input (phono jacks)

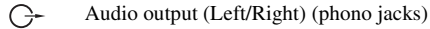
 Audio output (Left/Right) (phono jacks)

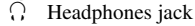
 Headphones jack

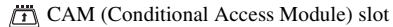
 CAM (Conditional Access Module) slot

MODEM

Modem jack (for future use only)

Sound Output

25 W + 25 W + 50 W (Sub-woofer)

Supplied Accessories

- Remote RM-ED001 (1)
- Size AA batteries (R6 type) (2)
- Coaxial cable (1)
- Mains lead (Type BF) (1)
- Bundling band (1) and screw (1)

Optional Accessories

- Wall-Mount Bracket SU-PW3M
- TV stand SU-PF3M

Design and specifications are subject to change without notice.

Troubleshooting

Check whether the ⏻ (standby) indicator is flashing in red.

When it is flashing

The self-diagnosis function is activated.



- 1 Count how many ⏻ (standby) indicator flashes between each two second break.
For example, the indicator flashes three times, then there is a two second break, followed by another three flashes, etc.
- 2 Press ⏻ on the TV (right side) to switch it off, disconnect the mains lead, and inform your dealer or Sony service centre of how the indicator flashes (number of flashes).

When it is not flashing



- 1 Check the items in the tables below.
- 2 If the problem still persists, have your TV serviced by qualified service personnel.

Picture

Problem	Cause/Remedy
No picture (screen is dark) and no sound	<ul style="list-style-type: none"> • Check the aerial connection. • Connect the TV to the mains, and press ⏻ on the TV (right side). • If the ⏻ (standby) indicator lights up in red, press TV I/⏻.
No picture or no menu information from equipment connected to the scart connector	<ul style="list-style-type: none"> • Check that the optional equipment is on and press /Ⓜ repeatedly until the correct input symbol is displayed on the screen. • Check the connection between the optional equipment and the TV.
Distorted picture	<ul style="list-style-type: none"> • Check if any connected optional equipment is installed in front of the TV or beside the TV. When installing optional equipment, leave some space between the optional equipment and the TV. • When changing programmes or selecting digital/analogue Text, turn off any equipment connected to the scart connector on the rear of the TV.
Double images or ghosting	<ul style="list-style-type: none"> • Check aerial/cable connections. • Check the aerial location and direction.
Only snow and noise appear on the screen	<ul style="list-style-type: none"> • Check if the aerial is broken or bent. • Check if the aerial has reached the end of its serviceable life (three to five years in normal use, one to two years at the seaside).
Picture (dotted lines or stripes) noise	<ul style="list-style-type: none"> • Keep the TV away from electrical noise sources such as cars, motorcycles, or hair-dryers. • Make sure that the aerial is connected using the supplied coaxial cable. • Keep the aerial cable away from other connecting cables. • Do not use a 300-ohm twin lead cable as interference may occur.
Picture noise when viewing a TV channel	<ul style="list-style-type: none"> • Select “Manual Programme Preset” in the “Set Up” menu and adjust “AFT” (Automatic Fine Tuning) to obtain better picture reception (page 31). • Select “Noise Reduction” in the “Picture Adjustment” menu to reduce the noise in the picture (page 22).
Stripe noise during playback/recording of a VCR	<ul style="list-style-type: none"> • Video head interference. Keep your VCR away from the TV. • Leave a space of 30 cm between your VCR and the TV to avoid noise. • Avoid installing your VCR in front of the TV or beside the TV.
Some tiny black points and/or bright points on the screen	<ul style="list-style-type: none"> • The picture of a display unit is composed of pixels. Tiny black points and/or bright points (pixels) on the screen do not indicate a malfunction.

Problem	Cause/Remedy
No colour on programmes	<ul style="list-style-type: none"> • Select “Reset” in the “Picture Adjustment” menu to return to the factory settings (page 22).
No colour or irregular colour when viewing a signal from the Y, Pb/Cb, Pr/Cr jacks of 	<ul style="list-style-type: none"> • Check the connection of the Y, Pb/Cb, Pr/Cr jacks of 4. • Make sure that the Y, Pb/Cb, Pr/Cr jacks of 4 are firmly seated in their respective sockets.

Sound

Problem	Cause/Remedy
No sound, but good picture	<ul style="list-style-type: none"> • Press  +/- or  (Mute). • Check that “Speaker” is set to “On” in the “Features” menu (page 26).
Noisy sound	<ul style="list-style-type: none"> • See the “Picture noise” causes/remedies on page 40.
Audio distortion	<ul style="list-style-type: none"> • See “Audio Filter” on page 31.

Channels

Problem	Cause/Remedy
The desired channel cannot be selected	<ul style="list-style-type: none"> • Switch between digital and analogue mode and select the desired digital/analogue channel.
Some channels are blank	<ul style="list-style-type: none"> • Scrambled/Subscription only channel. Subscribe to the Pay Per View service. • Channel is used only for data (no picture or sound). • Contact the broadcaster for transmission details.
Digital channel is not displayed	<ul style="list-style-type: none"> • Check that the aerial is plugged directly into the TV (not through other equipment). • Contact a local installer to find out if digital transmissions are provided in your area. • Upgrade to a higher gain aerial.

General

Problem	Cause/Remedy
The TV turns off automatically (the TV enters standby mode)	<ul style="list-style-type: none">• Check if the Sleep Timer function is activated (page 28).• Check if the Auto Shutoff is activated (page 28).• If no signal is received or no operation is performed in the TV mode for 10 minutes, the TV automatically switches to standby mode.
Some input sources cannot be selected	<ul style="list-style-type: none">• Select “AV Preset” in the “Set Up” menu and cancel “Skip” of the input source (page 30).
The remote does not function	<ul style="list-style-type: none">• Check that the remote is set correctly for the equipment you are using.• If the remote does not operate the equipment even when the remote has been set correctly to the equipment, enter the necessary code set as explained in “Programming the remote” (page 37).• Replace the batteries.
The ⏻ (standby) indicator flashes	<ul style="list-style-type: none">• Digital programme is set for “Timer REC”. For details, see “Checking the Digital Electronic Programme Guide (EPG)” on page 16.

Index

Numerics

- 0-9 buttons 8
- 14:9 15
- 4:3 15

A

- Accessories supplied 10
- Aerial, connecting 11
- AFT 31
- ANALOG button 8
- Analogue Text 15
- ATT 32
- Audio Filter 31
- Audio Language 33
- Audio Type 33
- Auto Format 25
- Auto Shutoff 28
- Auto Start Up 29
- Auto Tuning
 - analogue and digital channels 13
 - analogue channels only 29
 - digital channel only 32
- Auto Volume 23
- AUX/VIDEO I/II button 8
- AV Preset 30
- AV2 Output 26

B

- Backlight 21
- Balance 23
- Bass 23
- Batteries, inserting into the remote 10
- BBE 23
- Brightness 21

C

- CA Module Set-up 34
- Category list 16
- Channels

- auto-tuning 13
- selecting 14
- Skip 32

Colour 21

Colour Tone 21

Coloured buttons 8

Connecting

- an aerial/VCR 11
- optional equipment 35

Contrast 21

D

- Digital Auto Tuning 32
- DIGITAL button 8
- Digital Manual Tuning 33
- Digital Set Up 32
- Digital Set-up 33
- Digital Text 15
- Digital Text off (⏏) button 8
- Digital Tuning 32
- Dolby Virtual 23

- Dual Sound 24
- Dynamic Picture 22

E

- Edit 30
- Effect (sound effect) 23
- EPG (Digital Electronic Programme Guide) 16
- Equipment labels 30

F

- Fastext 15
- Favourite list 18
- Features menu 26

G

- Gamma Correction 22

H

- Headphones
 - connecting 35
 - Dual Sound 24
 - Volume 24
- Hue 21

I

- Info (i+) button 8
- Input select (←→) button 8, 9
- Input signal index table 19
- Interactive service 14

L

- Label 31
- Logo Illumination 27

M

- Manual Programme Preset 30
- Manual timer REC 17
- Media selector 8
- MENU button 8, 9
- Mode (Picture mode) 21
- Mute (ⓧ) button 8

N

- Noise Reduction 22
- Number buttons 8

O

- OK button 8, 9

P

- Parental Lock 34
- Picture Adjustment menu 21
- Picture mode (ⓧ) button 8
- Picture Off 27
- Picture Off (ⓧ) indicator 9
- PIN Code 34
- Power (I) indicator 9
- Power (ⓧ) switch 9
- Power Saving 26
- Previous channel (↶) button 8
- PROG +/- buttons 8, 9
- Programme index table 15
- Programme Labels 30

- Programme List Edit 33
- Programme Sorting 29

R

- Reminder 17
- Remote control
 - inserting batteries 10
 - overview 8
 - programming 37
 - sensor 9
- Reset
 - picture adjustment 22
 - sound adjustment 24

S

- Screen Control menu 25
- Screen Format 25
- Screen mode 15
- Screen mode (ⓧ) button 8
- Screen Shift 25
- Set Up menu 29
- Sharpness 21
- Skip 30, 32
- Sleep Timer 28
- Smart 15
- Sound Adjustment menu 23
- Sound effect (J) button 8
- Speaker 26
- Specifications 39
- Standby (ⓧ) indicator 9
- Subtitle Language 33
- Subtitle Setting 33

T

- Technical Set-up 34
- Text (ⓧ) button 8
- Text hold (ⓧ) button 8
- Text reveal (ⓧ) button 8
- Timer (ⓧ) indicator 9
- Timer list 17
- Timer menu 28
- Timer REC 16
- Treble 23
- TV standby (TV I/II) button 8

V

- VCR
 - connecting 11
 - programming 37
 - recording 16
- VCR double digit (-/-) button 8
- Volume (ⓧ) +/- buttons 8, 9

W

- Wide 15
- Woofer Level 24

Z

- Zoom 15