

KDL-V26A12U

Quick Start Guide

Follow steps **1** through **6** to quickly set up the TV for use.
For more information, see the Operating Instructions supplied with this manual.

© 2005 Sony Corporation Printed in Spain

1 Checking the accessories

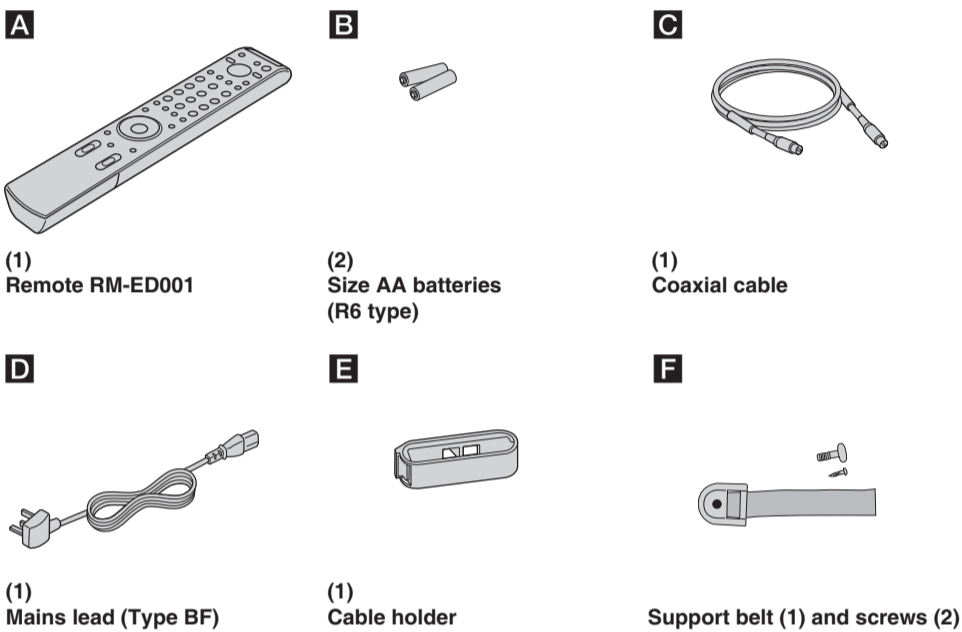

2 Inserting batteries into the remote

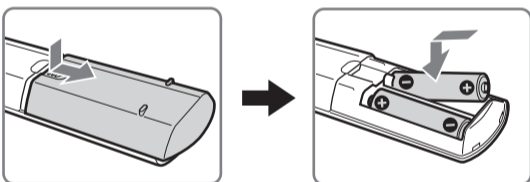

3 Connecting an aerial/VCR

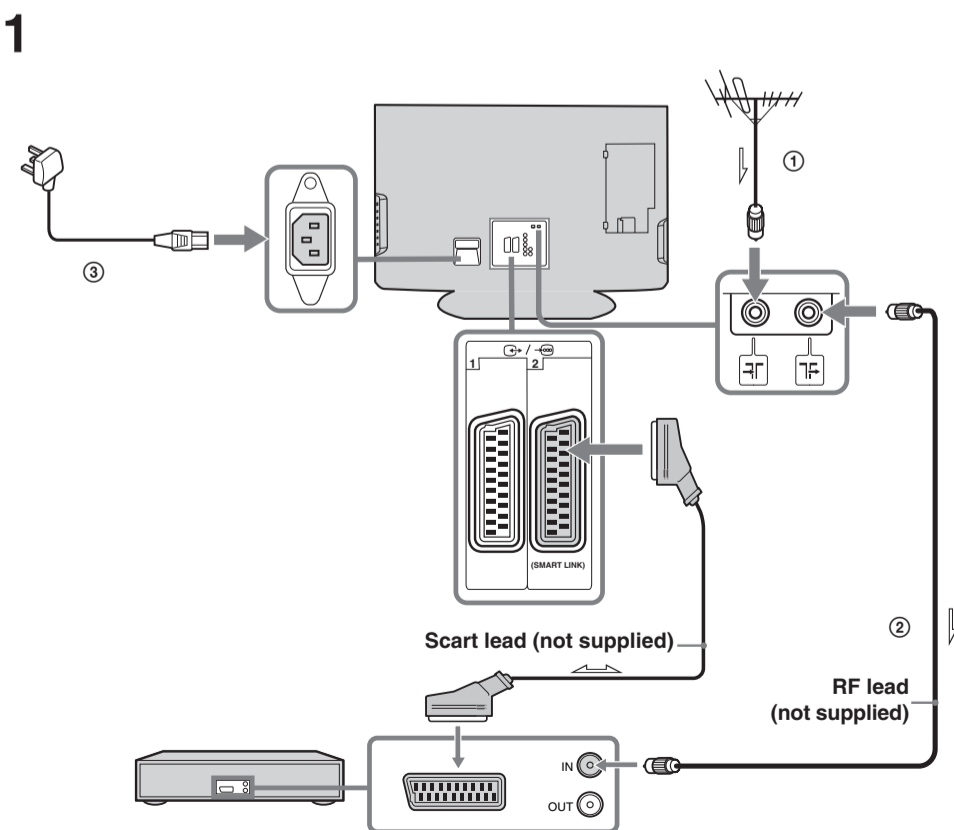

2

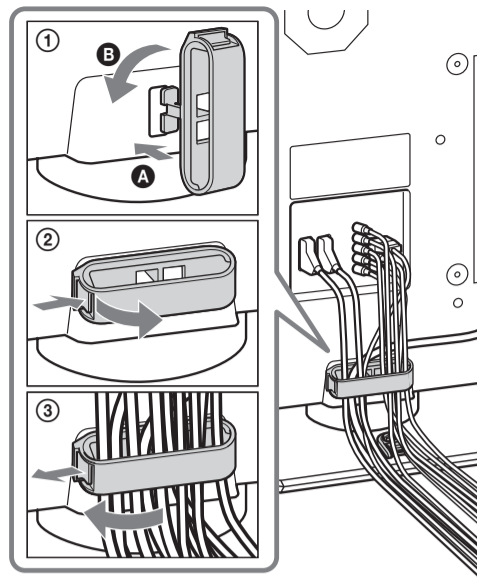

4

Preventing the TV from toppling over

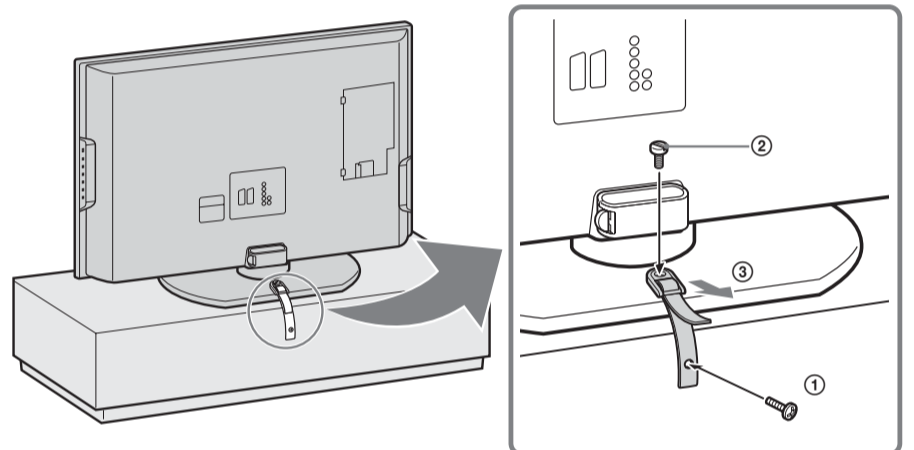

5

Switching on the TV

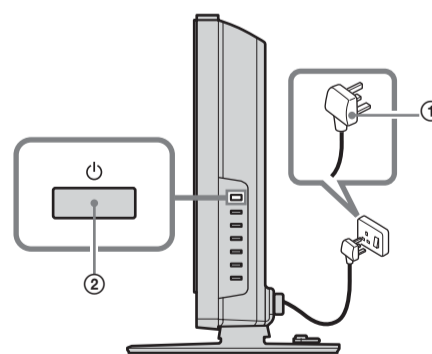

6

Auto-tuning the TV

1

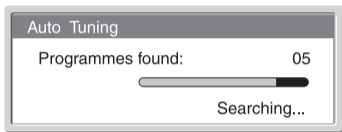
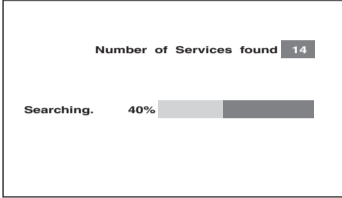
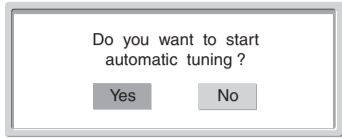

Select "Yes"

2

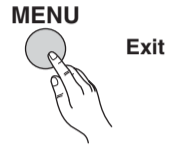
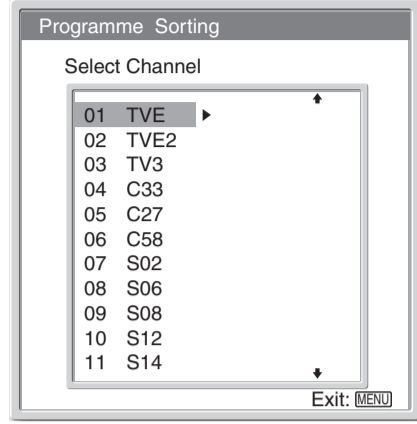

Exit



Your TV is now ready for use.

