

SONY

SONY®

HANDYCAM

Digital HD Video Camera Recorder

HANDYCAM®

Operating Guide

HDR-UX1E

GB

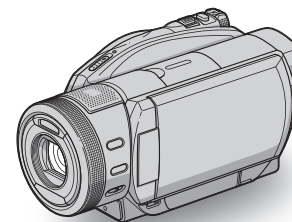

Enjoying your camcorder 12

Getting Started 25

Shooting 36

Playback 44

Editing 54

Dubbing/printing 61

Utilizing recording media 65

Customizing your camcorder 76

Using a Computer 96

Troubleshooting 103

Additional Information 123

Quick Reference 138

Additional information on this product and answers to frequently asked questions can be found at our Customer Support Website.

<http://www.sony.net/>



Printed on 100% recycled paper using VOC (Volatile Organic Compound)-free vegetable oil based ink.

Printed in Japan



2696729120

AVCHD



Read this before operating your camcorder

Before operating the unit, please read this manual thoroughly, and retain it for future reference.

WARNING

To reduce fire or shock hazard, do not expose the unit to rain or moisture.



CAUTION

The use of optical instruments with this product will increase eye hazard. Use of controls or adjustments or performance of procedures other than those specified herein may result in hazardous radiation exposure.

Replace the battery with the specified type only. Otherwise, fire or injury may result.

FOR CUSTOMERS IN THE UNITED KINGDOM

A moulded plug complying with BS1363 is fitted to this equipment for your safety and convenience.

Should the fuse in the plug supplied need to be replaced, a fuse of the same rating as the supplied one and approved by ASTA or BSI to BS1362 (i.e., marked with  or  mark) must be used.

If the plug supplied with this equipment has a detachable fuse cover, be sure to attach the fuse cover after you change the fuse. Never use the plug without the fuse cover. If you should lose the fuse cover, please contact your nearest Sony service station.

FOR CUSTOMERS IN EUROPE

CLASS 1 LASER PRODUCT
LASER KLASSE 1
LUOKAN 1 LASERLAITE
KLASS 1 LASERAPPARAT

ATTENTION

The electromagnetic fields at the specific frequencies may influence the picture and sound of this unit.

This product has been tested and found compliant with the limits set out in the EMC Directive for using connection cables shorter than 3 meters (9.8 feet).

Notice

If static electricity or electromagnetism causes data transfer to discontinue midway (fail), restart the application or disconnect and connect the communication cable (USB, etc.) again.



Disposal of Old Electrical & Electronic Equipment (Applicable in the European Union and other European countries with separate collection systems)

This symbol on the product or on its packaging indicates that this product shall not be treated as household waste. Instead it shall be handed over to the applicable collection point for the recycling of electrical and electronic equipment. By ensuring this product is disposed of correctly, you will help prevent potential negative consequences for the environment and human health, which could otherwise be caused by inappropriate waste handling of this product. The recycling of materials will help to conserve natural resources.

For more detailed information about recycling of this product, please contact your local Civic Office, your household waste disposal service or the shop where you purchased the product.

Applicable Accessory: Remote Commander

For customers in the U.S.A.

If you have any questions about this product, you may call:

Sony Customer Information Center
1-800-222-SONY (7669).

The number below is for the FCC related matters only.

Regulatory Information

Declaration of Conformity

Trade Name: SONY

Model No.: HDR-UX1E

Responsible Party: Sony Electronics Inc.

Address: 16530 Via Esprillo, San Diego, CA
92127 U.S.A.

Telephone No.: 858-942-2230

This device complies with Part 15 of the FCC Rules. Operation is subject to the following two conditions: (1) This device may not cause harmful interference, and (2) this device must accept any interference received, including interference that may cause undesired operation.

CAUTION

You are cautioned that any changes or modifications not expressly approved in this manual could void your authority to operate this equipment.

Note

This equipment has been tested and found to comply with the limits for a Class B digital device, pursuant to Part 15 of the FCC Rules.

These limits are designed to provide reasonable protection against harmful interference in a residential installation. This equipment generates, uses, and can radiate radio frequency energy and, if not installed and used in accordance with the instructions, may cause harmful interference to radio communications.

However, there is no guarantee that interference will not occur in a particular installation. If this equipment does cause harmful interference to radio or television reception, which can be determined by turning the equipment off and on, the user is encouraged to try to correct the interference by one or more of the following measures:

- Reorient or relocate the receiving antenna.
- Increase the separation between the equipment and receiver.
- Connect the equipment into an outlet on a circuit different from that to which the receiver is connected.
- Consult the dealer or an experienced radio/TV technician for help.

The supplied interface cable must be used with the equipment in order to comply with the limits for a digital device pursuant to Subpart B of Part 15 of FCC Rules.

Notes on use

Your camcorder is supplied with two kinds of operations guides.

- "Operating Guide" (This manual)
- "First Step Guide" for using your camcorder with the computer connected (stored on the supplied CD-ROM)



Types of the disc you can use in your camcorder



You can use the following discs only.

- 8cm DVD-R
- 8cm DVD-RW
- 8cm DVD+RW
- 8cm DVD+R DL

Use the discs with marks listed below. See page 16 for details.



For reliability durability of recording / playback, we recommend that you use Sony discs or discs with an  VIDEO CAMERA  *(for VIDEO CAMERA) mark for your DVD Handycam.

- Using a disc other than above may cause the unsatisfactory recording/playback or you may not be able to remove the disc from your DVD Handycam.
- * Depending on the place you bought, the disc has a  VIDEO CAMERA  your GAMESCOPE  mark.

Read this before operating your camcorder (Continued)

Types of “Memory Stick” you can use in your camcorder

There are two sizes of “Memory Stick.” You can use “Memory Stick Duo” marked with **MEMORY STICK DUO** or **MEMORY STICK PRO DUO** (p. 128).

“Memory Stick Duo”
(This size can be used with your camcorder.)



“Memory Stick”
(You cannot use it in your camcorder.)



- You cannot use any type of memory card except “Memory Stick Duo.”
- “Memory Stick PRO” and “Memory Stick PRO Duo” can be used only with “Memory Stick PRO” compatible equipment.

When using a “Memory Stick Duo” with “Memory Stick” compatible equipment

Be sure to insert the “Memory Stick Duo” into the Memory Stick Duo Adaptor.

Memory Stick Duo Adaptor

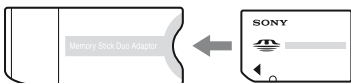

Using the camcorder

- Do not hold the camcorder by the following parts.

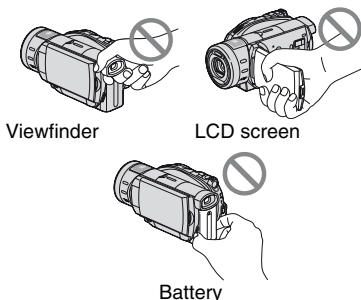

- The camcorder is not dustproofed, dripproofed or waterproofed. See “Maintenance and precautions” (p. 131).
- To prevent discs from being broken or recorded images from being lost, do not do the following when either of the respective lamps of the **POWER** switch (p. 29) or the **ACCESS** lamp (p. 33) is on:
 - to remove the battery pack or AC Adaptor from the camcorder.
 - to apply mechanical shock or vibration to the camcorder.
- When connecting your camcorder to another device with an HDMI cable, a component video cable, or a USB cable, be sure to insert the connector plug in the correct way. Pushing the plug forcibly into the terminal will damage the terminal and may result in a malfunction of your camcorder.

About menu items, LCD panel, viewfinder, and lens

- A menu item that is grayed out is not available under the current recording or playback conditions.
- The LCD screen and the viewfinder are manufactured using extremely high-precision technology, so over 99.99% of the pixels are operational for effective use. However, there may be some tiny black points and/or bright points (white, red, blue, or green in color) that appear constantly on the LCD screen and the

viewfinder. These points are normal results of the manufacturing process and do not affect the recording in any way.

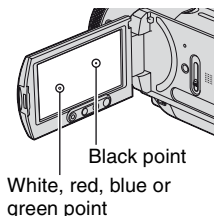

- Exposing the LCD screen, the viewfinder, or the lens to direct sunlight for long periods of time may cause malfunctions.
- Do not aim at the sun. Doing so might cause your camcorder to malfunction. Take images of the sun only in low light conditions, such as at dusk.

On recording

- Before starting to record, test the recording function to make sure the image and sound are recorded without any problems. You cannot delete images once you record them on a DVD-R/DVD+R DL. Use a DVD-RW/DVD+RW for trial recording (p. 16).
- Compensation for the contents of recordings cannot be provided, even if recording or playback is not possible due to a malfunction of the camcorder, storage media, etc.
- TV color systems differ depending on the countries/regions. To view your recordings on a TV, you need a PAL system-based TV.
- Television programs, films, video tapes, and other materials may be copyrighted. Unauthorized recording of such materials may be contrary to the copyright laws.

On playing the disc on other devices

You can play back, or format discs recorded with HD (high definition) image quality

only on AVCHD format compatible devices.

About this manual

- The images of the LCD screen and the viewfinder used in this manual for illustration purposes are captured using a digital still camera, and therefore may appear different.
- Design and specifications of recording media and other accessories are subject to change without notice.
- Disc in this Operating Guide refers to 8cm DVD discs.
- The on-screen displays in each local language are used for illustrating the operating procedures. Change the screen language before using your camcorder if necessary (p. 20).

About the Carl Zeiss lens

Your camcorder is equipped with a Carl Zeiss lens, which was developed jointly by Carl Zeiss, in Germany, and Sony Corporation, and produces superior images. It adopts the MTF measurement system for video cameras and offers a quality typical of a Carl Zeiss lens. Also, the lens for your camcorder is T*-coated to suppress unwanted reflections and faithfully reproduce colors.

MTF= Modulation Transfer Function. The number value indicates the amount of light from a subject coming into the lens.

About the marks used in this manual

- The operations available depend on the disc used. The following marks are used to indicate the type of disc you can use for a particular operation.

DVD
-R

DVD
-RW

DVD
+RW

DVD
+R DL

- These marks indicate the discs that can be used when recording with HD (high definition) image quality.

Table of Contents



Read This First (supplied)

Provides features and information about the camcorder you should know before using it.



Read this before operating your camcorder	2
Subject examples and solutions	10

Enjoying your camcorder

Operation flow	12
Experience the beauty of HD (high definition) images	14
Selecting the right disc	16
“  HOME” and “  OPTION”	
- Taking advantage of two types of menus	18

Getting Started

Step 1: Checking supplied items	25
Step 2: Charging the battery pack	26
Step 3: Turning the power on	29
Step 4: Adjusting the LCD panel and viewfinder	30
Step 5: Setting the date and time	31
Step 6: Inserting a disc or a “Memory Stick Duo”	33

Shooting

Recording the images	36
Zooming	
Recording sound with more presence (5.1ch surround recording)	
Using the flash	
Recording high quality still images during movie recording (Dual Rec)	
Recording in dark places (NightShot)	
Adjusting the exposure for backlit subjects	
Recording in mirror mode	
Recording the fast action in slow-motion (SMTH SLW REC)	
Controlling the image settings manually with the camera control ring	

Playback

Viewing the images	44
Using PB zoom	
Playing back a series of still images (Slide show)	
Playing the image on a TV	48

Editing

 (OTHERS) category	54
Deleting images	54
Dividing the image	56
Creating the Playlist	57





Dubbing/printing

 (SELECT DEVICES) category	61
Dubbing a disc	61
Dubbing to VCR or DVD/HDD recorders	62
Printing recorded images (PictBridge compliant printer)	63

Utilizing recording media

 (MANAGE DISC/MEMORY) category	65
Making the disc compatible with playback on other devices or DVD drives (Finalizing)	66
Playing a disc on other devices	70
Finding the right disc - DISC SELECT GUIDE	71
Deleting all scenes on the disc (Formatting)	72
Recording additional scenes after finalizing (Unfinalize)	74
Checking the disc information	75

Customizing your camcorder

What you can do with the  (SETTINGS) category of the HOME MENU	76
Using the HOME MENU	
List of the  (SETTINGS) category items	
MOVIE SETTINGS	78
(Items for recording movies)	
PHOTO SETTINGS	81
(Items for recording still images)	
VIEW IMAGES SET	84
(Items to customize the sound volume and display)	
SOUND/DISP SET	85
(Items to adjust beep and the screen)	
OUTPUT SETTINGS	86
(Items for when connecting other devices)	
CLOCK/ LANG	87
(Items to set clock and language)	
GENERAL SET	87
(Other setup items)	
Activating functions using the  OPTION MENU	88
Using the OPTION MENU	
Recording items on the OPTION MENU	89
PROGRAM AE, FADER, SPOT METER, etc.	
Viewing items on the OPTION MENU	95
VOLUME, SLIDE SHOW, SLIDE SHOW SET, etc.	

Using a Computer

What you can do with Windows computer	96
Installing the “First Step Guide” and software	98
Viewing “First Step Guide”	101
Using a Macintosh computer	101

Troubleshooting

Troubleshooting	103
Warning indicators and messages	118

Additional Information

Using your camcorder abroad	123
About the Disc	125
About the AVCHD format	127
About the “Memory Stick”	128
About the “InfoLITHIUM” battery pack	130
Maintenance and precautions	131
Specifications	134

Quick Reference

Identifying parts and controls	138
Indicators displayed during recording/playback	143
Glossary	146
Index	148

Subject examples and solutions

Shooting

Checking your golf swing

- ▶ Smooth slow recording 42



Flowers in close-up

- ▶ Soft portrait 91
- ▶ Focus 90
- ▶ Telemacro 90



Focusing on the dog on the left side of the screen

- ▶ Focus 90
- ▶ Spot focus 90



Focusing more distant objects

- ▶ Landscape 92
- ▶ Focus 90



Capturing still images during movie recording

- ▶ Dual Rec 40



Getting a good shot of a ski slope or beach

- ▶ Backlight 41
- ▶ Beach&Ski 91



A child on the stage under a spot light

- ▶ Spotlight 91



Fireworks with all its splendor

- ▶ Sunset&Moon 91
- ▶ Focus 90



A sleeping child under dim light

- ▶ NightShot 41
- ▶ Color Slow Shutter 92



Playback

Viewing on the TV screen48

Playing the disc on another device70

Editing, others

Deleting the unnecessary images54

Copying a disc for your friend61

Using the disc again72

Using your camcorder on a trip123

Operation flow

► **Unpack the camcorder and the supplied accessories.**

Read the supplied "Read This First" before you use your camcorder.

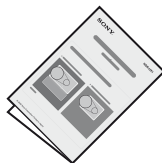

► **Prepare the right disc (p. 16).**

You can consult the [DISC SELECT GUIDE] (page 71) displayed on the screen to select the right disc.

- You will find a chart to help you select a disc in the supplied "Read This First."

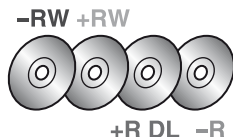

► **Initialize the disc (p. 33).**

When you format the disc, you can select the recording image quality, HD (high definition) or SD (standard definition).

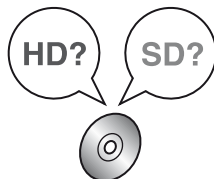

► **Shoot using your camcorder (p. 36).**

Movies are recorded on the disc, and still images are recorded on a "Memory Stick Duo."



Enjoying movies recorded with the HD (high definition) image quality

▶ You can view the movies with the HD (high definition) image quality (p. 48).

Notes

- Images recorded with the SD (standard definition) image quality cannot be converted to HD (high definition) image quality.

Tips

- If your TV is not a high definition TV, movies with HD (high definition) image quality will be displayed with SD (standard definition) image quality.
- You can consult the [TV CONNECT Guide] (p. 48) displayed on the screen on connecting your TV and camcorder.

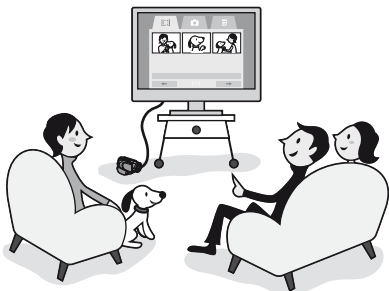

▶ Playing discs on AVCHD format compatible devices (p. 70).

Important notice regarding discs recorded in the AVCHD format

The camcorder captures high definition footage in the AVCHD format. DVD media containing AVCHD footage may not be used with standard DVD players or recorders, as the DVD player/recorder may fail to eject the media and may erase its contents without warning.

▶ Editing and copying disc contents (p. 62).

You can dub images recorded with HD (high definition) image quality by connecting your camcorder to a DVD device. Note that the dubbed images will be recorded with SD (standard definition) image quality.

Using a computer, you can edit or copy images recorded with HD (high definition) image quality.

Notes

- Install the supplied application software on the computer in advance.

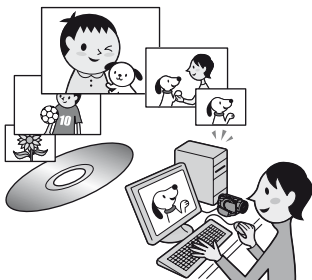

Experience the beauty of HD (high definition) images

► Your camcorder offers both AVCHD and DVD recording formats.

The recording format depends on the image quality, HD (high definition) or SD (standard definition). Select the image quality when you use a new disc on your camcorder (p. 33).

🔌 Notes

- You cannot change the image quality of a disc midway.
- The images recorded with SD (standard definition) image quality cannot be converted to HD (high definition) image quality.
- Your camcorder is compatible with the “1440 × 1080/50i” standard of AVCHD format (p. 127). “AVCHD 1080i format” is abbreviated as “AVCHD” in this manual, except when it must be described in more detail.

► HD (high definition) image quality

AVCHD format

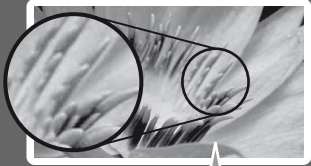

Image resolution:
about **3.75** times of that of SD
(standard definition)

Records high definition images.
Recommended whether or not you have a high definition TV.
The disc can be played only on the devices compatible with the AVCHD format (p. 70).

🔌 Notes

- AVCHD images cannot be played on most currently available DVD devices, which are incompatible with the AVCHD format.

💡 Tips

- AVCHD images can be viewed even on non-high definition TVs. The image quality, however, is equivalent to SD (standard definition) image quality (p. 48).

► SD (standard definition) image quality

DVD format



Records standard definition images.
Recommended if playback compatibility is important.
The disc can be played on DVD devices.

🔌 Notes

- DVD-RW (VR mode) discs can be played on the compatible devices only.

Recording time

Expected recordable time on one side of a disc

HD (high definition) image quality				(): the minimum recording time
AVCHD format	Approximate recordable time (min.)			
Recording mode	DVD-R	DVD-RW	DVD+RW	DVD+R DL
AVC HD 12M (HQ+) (highest quality)		15 (14)		27 (26)
AVC HD 9M (HQ) (high quality)		20 (14)		35 (26)
AVC HD 7M (SP) (standard quality)		25 (18)		45 (34)
AVC HD 5M (LP) (long play)		32 (26)		60 (50)

SD (standard definition) image quality				(): the minimum recording time
DVD format	Approximate recordable time (min.)			
Recording mode	DVD-R	DVD-RW	DVD+RW	DVD+R DL
SD 9M (HQ) (high quality)		20 (18)		35 (32)
SD 6M (SP) (standard quality)		30 (18)		55 (32)
SD 3M (LP) (long play)		60 (44)		110 (80)

Tips

- Figures such as 12M and 9M in the table show the average bit rate. M stands for Mbps.
- If you use a double-sided disc, you can record on both sides of the disc (p. 125).

Your camcorder uses the VBR (Variable Bit Rate) format to automatically adjust image quality to suit the recording scene. This technology causes fluctuations in the recording time of a disc. Movies containing quickly moving and complex images are recorded at a higher bit rate, and this reduces the overall recording time.









Selecting the right disc

You can use DVD-R, DVD-RW, DVD+RW, and DVD+R DL discs of 8 cm in diameter with your camcorder. What you can do with the recorded images depends on the image recording quality, HD (high definition) or SD (standard definition), and the type of disc you selected.

► Selecting the right disc for your purposes

The following reference materials are available.









- “Select the right disc” in the supplied “Read This First.”
- [DISC SELECT GUIDE] (p. 71).
- Disc characteristics explained on this page.

HD (high definition) image quality	Disc type			
What you can do on your camcorder using this type of disc				
(Disc symbols)				
Deleting images on your camcorder (54)	○	○	-	-
Editing images on your camcorder (56)	○	○	-	-
Finalizing required to play on other devices (66)	○	○	○	○
Making additional recordings on a finalized disc (74)	○	○	-	-
Formatting the used disc to use it again (72)	○	○	-	-
Making longer recordings on a side of a disc	-	-	○	-

() indicates the reference page.

🔊 Notes

- The aspect ratio of images recorded with HD (high definition) image quality is 16:9 (wide).

SD (standard definition) image quality	Disc type				
What you can do on your camcorder using this type of disc					
(Disc symbols)					
Recording movies at an aspect ratio of 16:9 (wide) and 4:3 on a disc (34)	○	○	-	○	○
Deleting images on your camcorder (54)	-	○	-	-	-
Editing images on your camcorder (56)	-	○	-	-	-
Finalizing required to play on other devices (66)	○	○	-*2	○	○
Making additional recordings on a finalized disc (74)	○	○	○	-	-
Creating DVD menus during finalizing (66)	○	-	○	○	○
Formatting the used disc to use it again (72)	○	○	○	-	-
Making longer recordings on a side of a disc	-	-	-	○	-

() indicates the reference page.

*1 There are 2 recording formats, VIDEO mode and VR mode, for DVD-RW.

*2 Finalizing is required to play the disc in a DVD drive on a computer. A DVD+RW that is not finalized may cause the computer to malfunction.

“HOME” and “OPTION”

- Taking advantage of two types of menus

“HOME MENU” - the starting point for all operations with your camcorder

When you want to customize your camcorder, open the “HOME MENU.” This menu is the gateway to all the functions of your camcorder. See page 20 for further details.

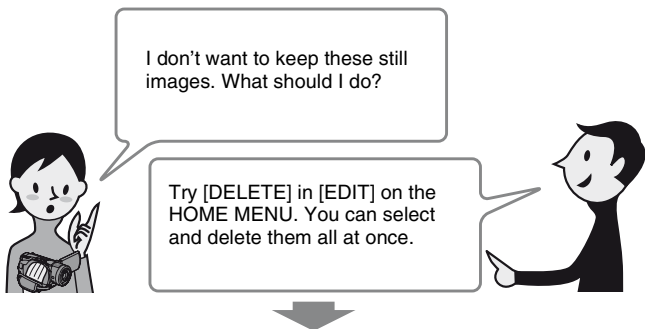

[?] (HELP)

Displays a description of the item (p. 22).

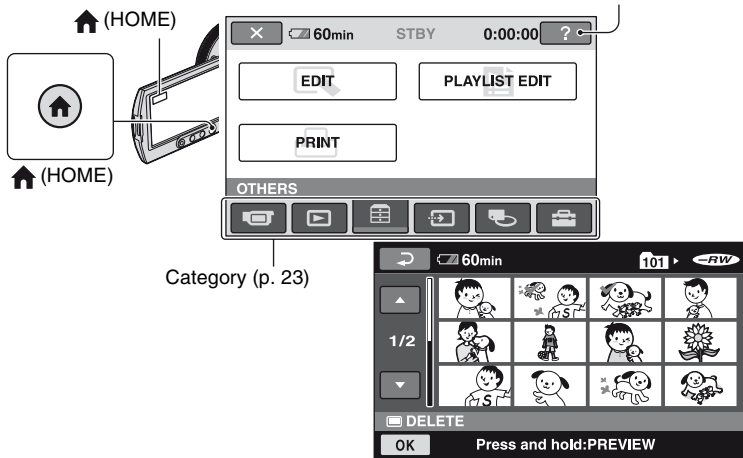

“OPTION MENU” enables you to access functions directly

Just a touch on the screen during shooting or playback displays the functions available at that moment. You will find it easy to make various settings. See page 24 for further details.

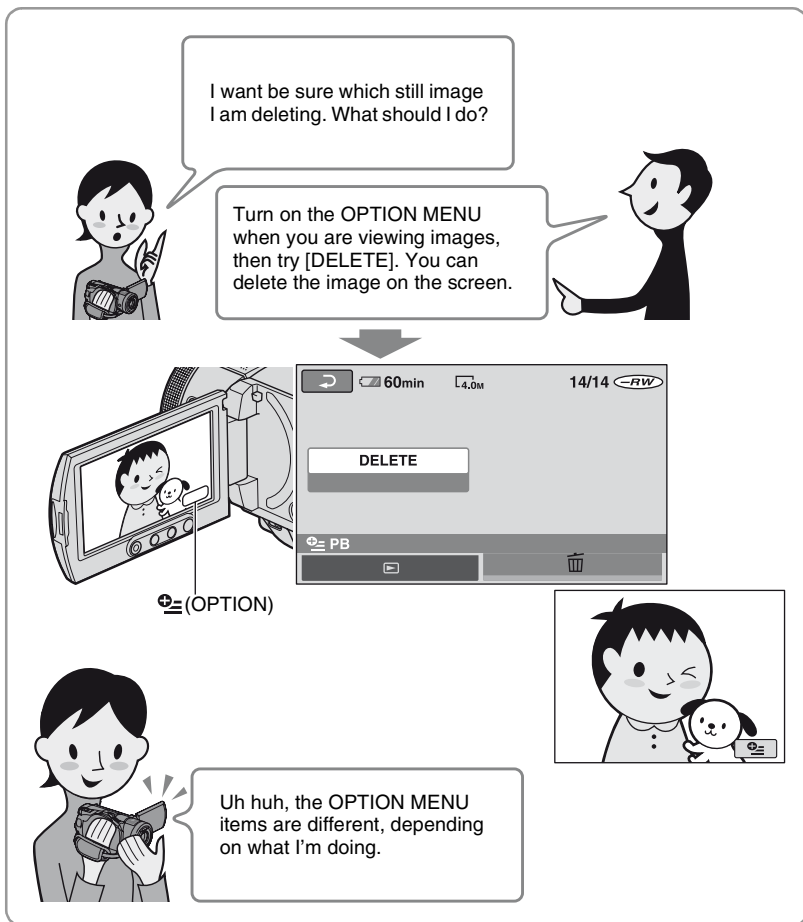

■ Notes on the menu operation

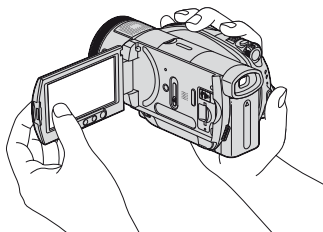

Place your fingers on the rear side of the LCD panel (touch panel) to support it. Then, touch the buttons displayed on the screen with your thumb.



Perform the same actions as explained above when you press the buttons on the LCD panel.

- Be careful not to press the buttons below the LCD panel accidentally while using the touch panel.
- If the buttons on the touch panel do not work correctly, adjust the touch panel (CALIBRATION) (p. 132).

Changing the language setting

You can change the on-screen displays to show messages in a specified language. To select the screen language, touch  (SETTINGS) → [CLOCK/  LANG] → [ LANGUAGE SET] (p. 87).

Using the HOME MENU

Selecting and deleting a still image on the edit screen is explained as an example.

- 1 Slide the POWER switch to turn on your camcorder.

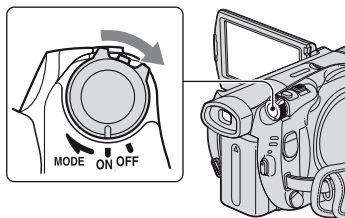

- 2 Press  (HOME)  (or ).

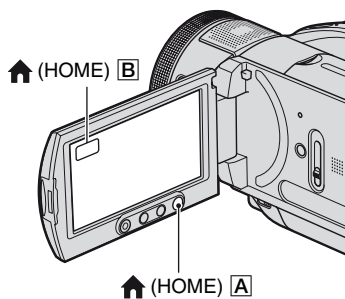

HOME MENU



Category (p. 23)

3 Touch the (OTHERS) category.



4 Touch [EDIT].

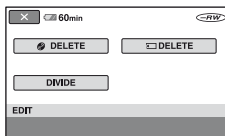

5 Touch [] DELETE.



6 Touch [] DELETE.



7 Touch the image you want to delete.

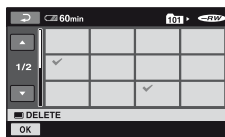

8 Touch [OK] → [YES] → [OK].

► **When you want to know something about the function of each item on the HOME MENU - HELP**

1 Press  (HOME).

The HOME MENU appears.



2 Touch  (HELP).

The bottom of the  (HELP) button turns orange.



3 Touch the item you want to know the content.









When you touch an item, its explanation appears on the screen.

To apply the option, touch [YES], otherwise, touch [NO].

To deactivate the HELP

Touch  (HELP) in step 2.

► Categories and items of the HOME MENU

Category	Item
CAMERA 	MOVIE (p. 37) PHOTO (p. 38) SMTH SLW REC (p. 42)
VIEW IMAGES 	VISUAL INDEX (p. 46) PLAYLIST (p. 57)
OTHERS 	EDIT (p. 54) PLAYLIST EDIT (p. 57) PRINT (p. 63)
SELECT DEVICES 	COMPUTER (p. 61) TV CONNECT Guide (p. 48) PRINTER (p. 63)
MANAGE DISC/MEMORY 	FINALIZE (p. 66) DISC SELECT GUIDE (p. 71) Ⓜ️ FORMAT (p. 72) □️ FORMAT (p. 73) UNFINALIZE (p. 74) DISC INFO (p. 75)
SETTINGS 	To customize your camcorder (p. 76).

Using the OPTION MENU

Deleting a still image during viewing is explained as an example.

- 1 While viewing the still image you want to delete, touch  (OPTION) on the screen.

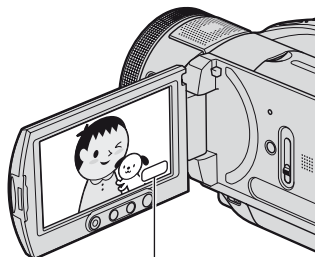

 (OPTION)

OPTION MENU

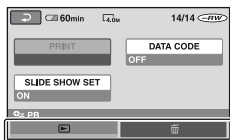

Tab

- 2 Touch .



- 3 Touch [DELETE] → [YES] → .

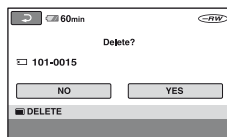

Items on the OPTION MENU

See pages 89 and 95.

When the item you want is not on the screen

Touch another tab. If you cannot find the item anywhere, the function does not work under the situation.

Notes

- The tabs and items that appear on the screen depend on the recording/playback status of your camcorder at the time.
- Some items appear without a tab.

Step 1: Checking supplied items

Make sure that you have the following items supplied with your camcorder. The number in the parentheses indicates the number of that item supplied.

AC Adaptor (1) (p. 26)

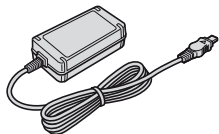

Mains lead (1) (p. 26)



Component video cable (1) (p. 49)

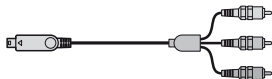

A/V connecting cable (1) (p. 49, 62)



USB cable (1) (p. 63)

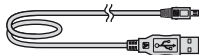

Wireless Remote Commander (1)
(p. 142)



A button-type lithium battery is already installed.

Rechargeable battery pack NP-FM50 (1)
(p. 26, 130)

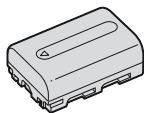

CD-ROM "Handycam Application Software" (1) (p. 96)

Read This First (1)

Operating Guide (This manual) (1)

⚠ Notes

- Discs and "Memory Stick Duo" are not included.

Step 2: Charging the battery pack

You can charge the “InfoLITHIUM” battery pack (M series) (p. 130) after attaching it to your camcorder.

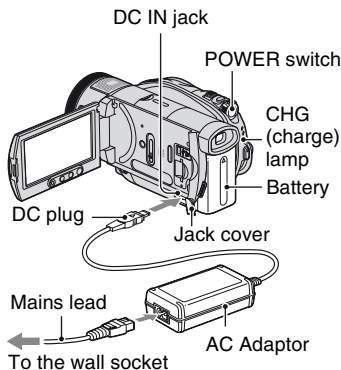

- 1 Slide the **POWER** switch in the direction of the arrow to **OFF (CHG)** (The default setting).

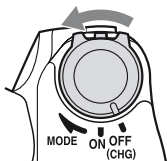

- 2 Attach the battery pack by sliding it in the direction of the arrow until it clicks.

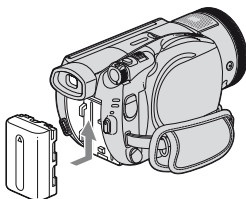

- 3 Connect the **AC Adaptor** to the **DC IN jack** of your camcorder.

Open the jack cover, and connect the DC plug of the AC Adaptor.

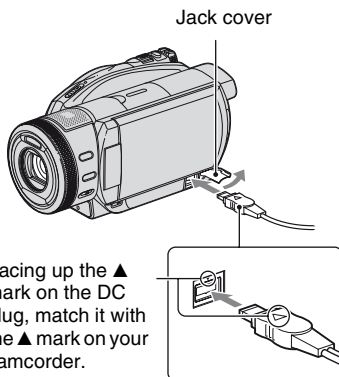

- 4 Connect the mains lead to the **AC Adaptor** and the wall socket.

The CHG (charge) lamp lights up and charging starts. The CHG (charge) lamp turns off when the battery is fully charged.

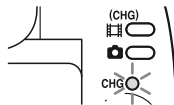

- 5 Disconnect the **AC Adaptor** from the **DC IN jack** on your camcorder.

⚡ Notes

- Disconnect the AC Adaptor from the DC IN jack holding both the camcorder and the DC plug.

Tips

- If you attach the battery pack or connect the AC Adaptor when the POWER switch is set to OFF (CHG), your camcorder turns on, then off again, after a few seconds.

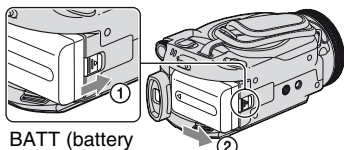

To remove the battery pack

Slide the POWER switch to OFF (CHG). Slide the BATT (battery release) lever and remove the battery pack.



BATT (battery release) lever

Notes

- When you remove the battery pack, make sure that the  (Movie) lamp/ (Still) lamp (p. 29) is turned off.

When storing the battery pack

Fully discharge the battery before storing it for an extended period (see page 130 for the details of storage).

To use an outside power source

Make the same connections as you do when charging the battery pack. The battery pack will not lose its charge in this case.

To check the remaining battery (Battery Info)

Set the POWER switch to OFF (CHG), then press DISP/BATT INFO.

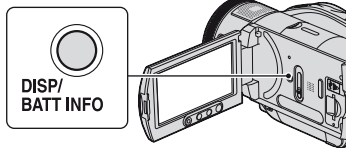

After a while, the approximate recordable time in the selected format and battery information appear for about 7 seconds. You can view the battery information for up to 20 seconds by pressing DISP/BATT INFO again while the information is displayed.

Remaining battery (approx.)

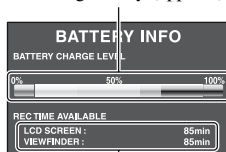

Recording capacity (approx.)

Charging time

Approximate time (min.) required when you fully charge a fully discharged battery pack.

Battery pack	Charging time
NP-FM50 (supplied)	150
NP-QM71D	260
NP-QM91D	360

Recording time

Approximate time (min.) available when you use a fully charged battery pack.

HD (high definition) image quality

Battery pack	Continuous recording time	Typical recording time*
NP-FM50 (supplied)	95	50
	100	55
	95	50
NP-QM71D	235	125
	245	130
	240	130

Step 2: Charging the battery pack (Continued)

Battery pack	Continuous recording time	Typical recording time*
NP-QM91D	360	195
	375	205
	365	200

SD (standard definition) image quality

Battery pack	Continuous recording time	Typical recording time*
NP-FM50 (supplied)	120	65
	125	65
	120	65
NP-QM71D	300	165
	305	165
	300	165
NP-QM91D	455	250
	465	255
	455	250

* Typical recording time shows the time when you repeat recording start/stop, turning the power on/off and zooming.

Notes

- All times measured with recording mode [SP] under the following conditions:
Top: When the LCD backlight turns on.
Middle: When the LCD backlight turns off.
Bottom: Recording time when recording with the viewfinder while the LCD panel is closed.

Playing time

Approximate time (min.) available when you use a fully charged battery pack.

HD (high definition) image quality



Battery pack	LCD panel opened*	LCD panel closed
NP-FM50 (supplied)	125	125
NP-QM71D	305	305
NP-QM91D	465	465

SD (standard definition) image quality

Battery pack	LCD panel opened*	LCD panel closed
NP-FM50 (supplied)	140	145
NP-QM71D	340	355
NP-QM91D	520	535

* When the LCD backlight is on.

On the battery pack

- Before changing the battery pack, slide the POWER switch to OFF (CHG) and turn off the  (Movie) lamp/ (Still) lamp (p. 29).
- The CHG (charge) lamp flashes during charging, or Battery Info (p. 27) will not be correctly displayed under the following conditions:
 - The battery pack is not attached correctly.
 - The battery pack is damaged.
 - The battery pack is worn-out (For Battery Info only).
- The power will not be supplied from the battery as long as the AC Adaptor is connected to the DC IN jack of your camcorder, even when the mains lead is disconnected from the wall socket.
- When attaching an optional video light, it is recommended that you use an NP-QM71D or NP-QM91D battery pack.
- We do not recommend using an NP-FM30, which only allows short recording and playback times, with your camcorder.

On the charging/recording/playback time

- Times measured when using the camcorder at 25 °C (77 °F) (10 °C to 30 °C (50 °F to 86 °F) is recommended).
- The recording and playback time will be shorter when you use your camcorder in low temperatures.
- The recording and playback time will be shorter depending on the conditions under which you use your camcorder.

Step 3: Turning the power on

On the AC Adaptor

- Use the nearby wall socket when using the AC Adaptor. Disconnect the AC Adaptor from the wall socket immediately if any malfunction occurs while using your camcorder.
- Do not use the AC Adaptor placed in a narrow space, such as between a wall and furniture.
- Do not short-circuit the DC plug of the AC Adaptor or battery terminal with any metallic objects. This may cause a malfunction.

PRECAUTION

- Even if your camcorder is turned off, AC power (mains) is still supplied to it while connected to the wall socket via the AC Adaptor.

To record, slide the POWER switch repeatedly to turn on the respective lamp. When using it for the first time, the [CLOCK SET] screen appears (p. 31).

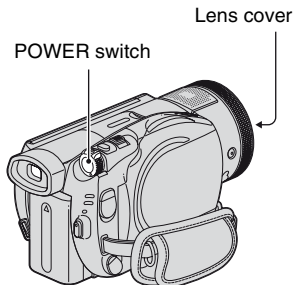

While pressing the green button in the center, slide the POWER switch repeatedly in the direction of the arrow to turn on the power.

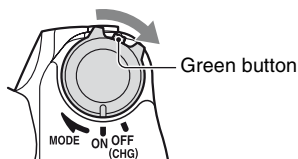

When you record, switch the power mode by sliding the POWER switch in the direction of the arrow until the respective lamp lights up.

 **(Movie):** To record movies

 **(Still):** To record still images

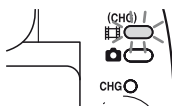

Step 3: Turning the power on (Continued)

To turn off the power

Slide the POWER switch to OFF (CHG).

🔌 Notes

- It takes a few seconds for your camcorder to be ready to shoot after the power is turned on. You cannot operate your camcorder during this time.
- The lens cover opens automatically when the power is turned on. It closes when the playback screen is selected, or the power is turned off.
- In the setting at the time of purchase, the power turns off automatically if you leave your camcorder without any operation attempted for approximately 5 minutes, to save battery power ([A.SHUT OFF], p. 88).

Step 4: Adjusting the LCD panel and viewfinder

LCD panel

Open the LCD panel 90 degrees to the camcorder (①), then rotate it to the best angle to record or play (②).

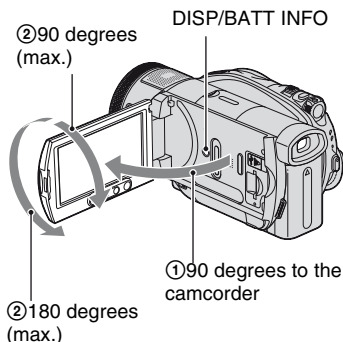

To turn off the LCD backlight to make the battery last longer

Press and hold DISP/BATT INFO for a few seconds until  appears.

This setting is practical when you use your camcorder in bright conditions or you want to save battery power. The recorded image will not be affected by the setting. To turn on the LCD backlight, press and hold DISP/BATT INFO for a few seconds until  disappears.

To hide the screen indicators

Press DISP/BATT INFO to toggle the screen indicators (such as time code) on or off.

🔌 Notes

- Do not press the buttons below the LCD screen accidentally when you open or adjust the LCD panel.

Step 5: Setting the date and time

💡 Tips

- If you open the LCD panel 90 degrees to the camcorder, then rotate it 180 degrees to the lens side, you can close the LCD panel with the LCD screen facing out. This is convenient during playback operations.
- On the HOME MENU, touch  (SETTINGS) → [SOUND/DISP SET] → [LCD BRIGHT] (p. 85) to adjust the brightness of the LCD screen.

Viewfinder

You can view images using the viewfinder to avoid wearing down the battery, or when the image seen on the LCD screen is poor.

Viewfinder

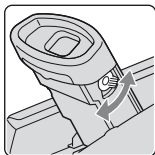

Viewfinder lens adjustment lever
Move it until the image is clear.

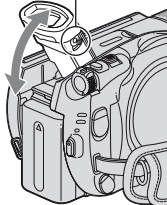

💡 Tips

- You can adjust the brightness of the viewfinder backlight by selecting  (SETTINGS) → [SOUND/DISP SET] → [VF B.LIGHT] on the HOME MENU (p. 85).

Set the date and time when using this camcorder for the first time. If you do not set the date and time, the [CLOCK SET] screen appears every time you turn on your camcorder or change the POWER switch position.

🔔 Notes

- If you do not use your camcorder for **about 4 months**, the built-in rechargeable battery gets discharged and the date and time settings may be cleared from the memory. In that case, charge the built-in rechargeable battery and then set the date and time again (p. 133).

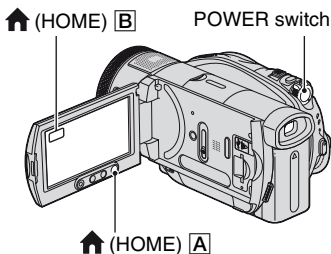

Skip to step 5 when you set the clock for the first time.

- 1 Press  (HOME)  (or ) to display the HOME MENU.



- 2 Touch  (SETTINGS).

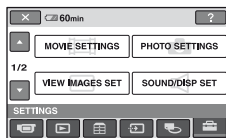

Step 5: Setting the date and time (Continued)

-
- 3** Display [CLOCK/🗓️LANG] with ▲/▼, then touch it.

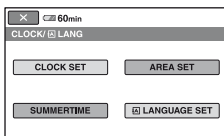

-
- 4** Touch [CLOCK SET].

-
- 5** Select the desired geographical area with ▲/▼, then touch [NEXT].

-
- 6** Set [SUMMERTIME], then touch [NEXT].

-
- 7** Set [Y] (year) with ▲/▼.

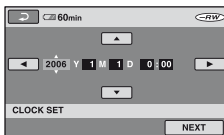

-
- 8** Select [M] with ◀/▶, then set the month.

-
- 9** Set [D] (day), hour and minute in the same way, then touch [NEXT].

-
- 10** Make sure that the clock is correctly set, then touch [OK].

The clock starts.

You can set any year up to the year 2037.

💡 Tips

- The date and time does not appear during recording, but they are automatically recorded on the disc, and can be displayed during playback (see page 84 for [DATA CODE]).
- Refer to page 124 for information concerning “World time difference.”

Step 6: Inserting a disc or a “Memory Stick Duo”

Disc

A new 8 cm DVD-R, DVD-RW, DVD+RW, or DVD+R DL is required for recording (p. 16).

Notes

- Remove dust or fingerprints from the disc beforehand, using a soft cloth (p.126).

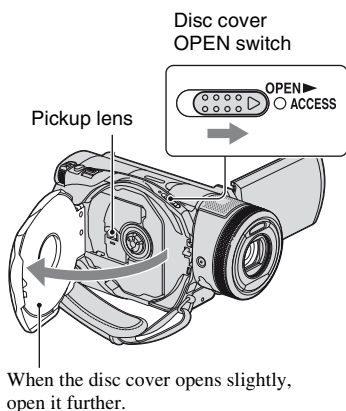
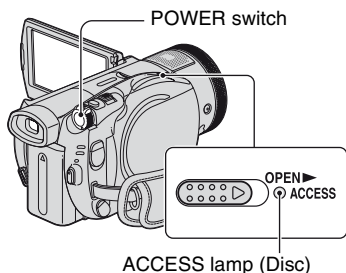

1 Check that the power of your camcorder is on.

2 Slide the disc cover OPEN switch in the direction of the arrow (OPEN ►).

[PREPARING TO OPEN] appears on the LCD screen. Then the opening chime sounds, followed by bip, bip.

After the bips stop, the disc cover opens slightly, automatically.

3 Set the disc with the recording side facing your camcorder, then press the center of the disc until it clicks.

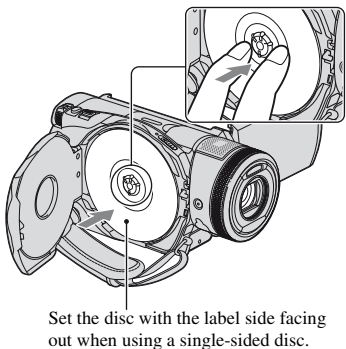

4 Close the disc cover.

[DISC ACCESS] appears on the LCD screen.

It may take some time for the camcorder to recognize the disc, depending on the disc type and condition.

Step 6: Inserting a disc or a “Memory Stick Duo” (Continued)

Skip to step 6 when you use a DVD-R/DVD+R DL.

5 When you use a DVD-RW/DVD+RW, touch [Use DISC SELECT GUIDE].

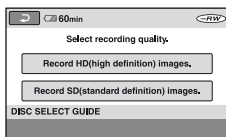

6 Touch [Record HD (high definition) images.].

Touch [Record SD (standard definition) images.] to record with SD (standard definition) image quality.

Items displayed vary depending on the status of your camcorder, or the type of disc inserted.

Notes

- You cannot change the image quality (HD (high definition) or SD (standard definition)) of a disc midway.
- See page 14 for details on HD (high definition)/SD (standard definition) image quality.

7 Touch the option that is right for you on the screen.

The disc will be formatted with the image recording quality and mode you selected. When the formatting is completed, you can start recording on the disc.

If you select SD (standard definition) image quality

- When you use a DVD-RW, a record mode, [VIDEO] or [VR], will be assigned automatically (p. 17).
- When you use a DVD+RW, select the aspect ratio, [16:9 WIDE] or [4:3].

To remove the disc

Perform steps 1 and 2 to open the disc cover, then remove the disc.

Notes

- Be careful not to obstruct the operation with your hand or other objects, etc., when opening or closing the disc cover. Move the belt to the bottom of the camcorder, then open or close the disc cover.
- If you catch the belt when closing the disc cover, it may cause your camcorder to malfunction.
- Do not touch the disc with the recording side or pickup lens (p.133).
When using a double-sided disc, take care not to smudge the surface with fingerprints.
- If you close the disc cover with the disc set incorrectly, it may cause your camcorder to malfunction.
- Do not disconnect the power sources during formatting.
- Do not apply shock or vibration to your camcorder:
 - while the ACCESS lamp is on
 - while the ACCESS lamp is flashing
 - while [DISC ACCESS] or [PREPARING TO OPEN] is displayed on the LCD screen
- It may take some time to remove the disc depending on the disc condition or recorded materials.
- It may take up to 10 minutes to remove a disc if it is damaged or is dirty with fingerprints, etc. In that case, the disc might be damaged.

Tips

- You can remove the disc when a power source is connected to your camcorder even when your camcorder is turned off. However, the disc recognition process (step 4) does not start.
- To delete all of the previously recorded images from a DVD-RW/DVD+RW, then to use it

again to record new images, see “Deleting all scenes on the disc (Formatting)” on page 72.

- You can check the right disc using [DISC SELECT GUIDE] on the HOME MENU (page 71).

“Memory Stick Duo”

You can use only a “Memory Stick Duo” marked with MEMORY STICK DUO or MEMORY STICK PRO DUO (p. 128).

1 Open the LCD panel.

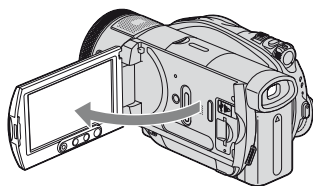

2 Insert the “Memory Stick Duo” into the “Memory Stick Duo” slot in the right direction until it clicks.

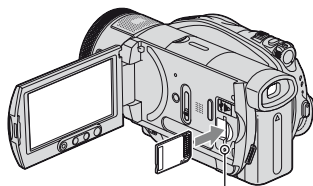

Access lamp
 (“Memory Stick Duo”)

To eject a “Memory Stick Duo”

Open the LCD panel, lightly push the “Memory Stick Duo” in once.

Notes

- When the access lamp is lit or flashing, your camcorder is reading/writing data. Do not shake or knock your camcorder, turn the power off, eject the “Memory Stick Duo,” or remove the battery pack. Otherwise, image data may be damaged.
- If you force the “Memory Stick Duo” into the slot in the wrong direction, the “Memory Stick Duo,” the “Memory Stick Duo” slot, or image data may be damaged.
- When inserting or ejecting the “Memory Stick Duo,” be careful so that the “Memory Stick Duo” does not pop out and drop.

Tips

- The number of recordable images vary, depending on the image quality or the image size. For details, see page 81.

Recording the images

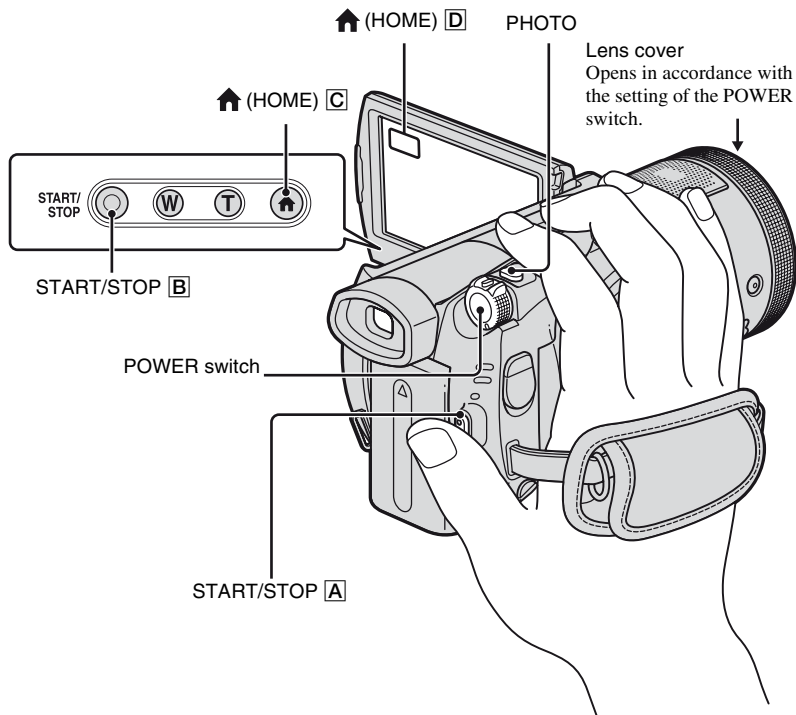

Fastening the grip belt

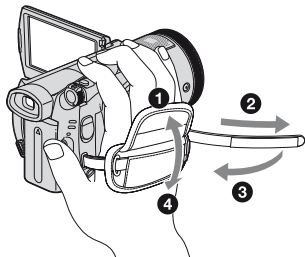

Notes

- If the ACCESS lamp (page 33, 35) is on after recording is finished, it means data is still being written onto the disc or "Memory Stick Duo." Do not apply shock or vibration to your camcorder, and do not disconnect the battery or AC Adaptor.

Recording movies

Movies are recorded on the disc.

- 1 Slide the **POWER** switch in the direction of the arrow to light up the  (Movie) lamp.

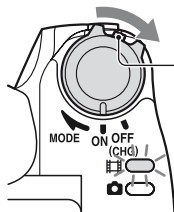

Slide the **POWER** switch in the direction of the arrow while pressing the green button only when the **POWER** switch is in the **OFF (CHG)** position.

- 2 Press **START/STOP**  (or ).

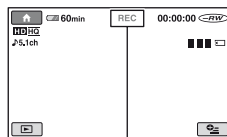
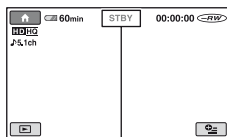





To stop recording, press **START/STOP** again.

To record high resolution still images on the “Memory Stick Duo” during shooting a movie (Dual Rec)

→ See page 40.

To switch to the movie recording mode using the  (HOME) button

- ① Press  (HOME)  (or ) when the power of the camcorder is on.
- ② Touch the  (CAMERA) category on the HOME MENU.
- ③ Touch [MOVIE].

Recording the images (Continued)

Recording still images

Still images are recorded on the “Memory Stick Duo.”

- 1** Slide the **POWER** switch in the direction of the arrow to light up the  (Still) lamp.

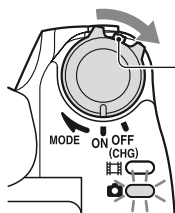

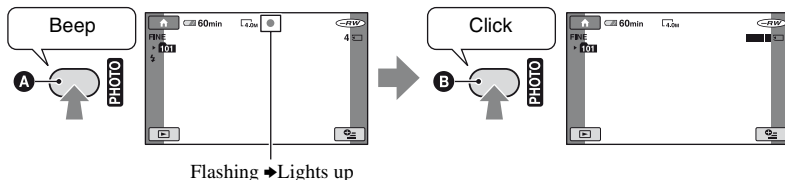

Slide the **POWER** switch in the direction of the arrow while pressing the green button only when the **POWER** switch is in the **OFF (CHG)** position.

- 2** Press **PHOTO** lightly to adjust the focus **A**, then press it fully **B**.



A shutter sound is heard. When  disappears, the image has been recorded.

To switch to the still image recording mode using the (HOME) button

- ① Press  (HOME) **C** (or **D**) when the power of the camcorder is on.
- ② Touch the  (CAMERA) category on the HOME MENU.
- ③ Touch [PHOTO].

Zooming

You can magnify images from about 1.1 to 10 times the original size with the power zoom lever or the zoom buttons below the LCD screen.

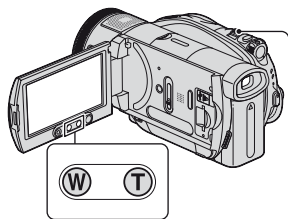

Wider range of view:
(Wide angle)

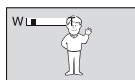

Close view: (Telephoto)

Move the power zoom lever slightly for a slower zoom. Move it further for a faster zoom.

Notes

- Be sure to keep your finger on the power zoom lever. If you move your finger off the power zoom lever, the operation sound of the power zoom lever may also be recorded.
- You cannot change the zoom speed with the zoom buttons below the LCD screen.
- The minimum possible distance between camcorder and subject while maintaining sharp focus is about 1 cm (about 13/32 in.) for wide angle and about 80 cm (about 2 5/8 feet) for telephoto.

Tips

- You can set [DIGITAL ZOOM] (p. 79) if you want to zoom to a level greater than 10 x.

Recording sound with more presence (5.1ch surround recording)

Sound picked up by the built-in 4ch microphone is converted to 5.1ch surround sound and recorded.

Active
Interface Shoe

Built-in 4ch microphone

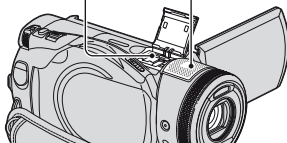

Your camcorder has Dolby Digital 5.1 Creator installed for recording 5.1ch surround sound. Enjoy realistic sound when playing the disc on devices that support 5.1ch surround sound.

Dolby Digital 5.1 Creator, 5.1ch surround sound
Glossary (p.146)

Notes

- To play the disc recorded with HD (high definition) image quality and enjoy the sound in 5.1ch surround, you need an AVCHD format device compatible with 5.1ch surround (page 70).
- 5.1ch sound is converted to 2ch when played back on your camcorder.
- 5.1ch is displayed on the screen during 5.1ch recording/playback.

To record with a wireless microphone

By attaching the wireless microphone (optional*) to the Active Interface Shoe (p. 139), you can record distant sound. This distant sound is allotted to the front center part of the 5.1ch surround sound, mixed with the sound picked up by the built-in 4ch microphone, and recorded. You can enjoy more realistic sound by playing

Recording the images (Continued)

the disc on the device that supports 5.1ch surround sound.

For details, refer to the instruction manual of your wireless microphone.

* Optional wireless microphone is not available in all countries/regions.

Using the flash

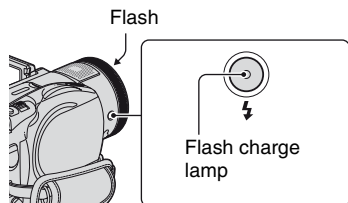

Press  (flash) repeatedly to select an appropriate setting.

No indication (Auto flash): Automatically flashes when there is insufficient ambient light.

 (Forced flash): Always uses the flash regardless of the surrounding brightness.

 (No flash): Records without flash.

Notes

- The recommended distance to the subject when using the built-in flash is approximately 0.5 to 2.5 m (1 5/8 to 8 feet).
- Remove any dust from the surface of the flash lamp before using it. Flash effect may be impaired if heat discoloration or dust obscures the lamp.
- The flash charge lamp flickers while charging the flash, and remains lit when the battery charge is complete.
- If you use the flash in bright places such as when shooting a backlit subject, the flash may not be effective.
- When attaching a conversion lens (optional) or a filter (optional) to your camcorder, the flash light does not emit light.

Tips

- You can change the brightness of the flash by setting [FLASH LEVEL] (p. 83), or you can prevent the redeye by setting [REDEYE REDUC] (p. 83).

Recording high quality still images during movie recording (Dual Rec)

You can record high quality still images on the "Memory Stick Duo" while recording a movie on the disc.

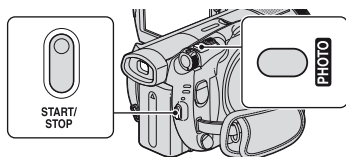

① Press START/STOP to start movie recording.

② Press PHOTO fully.

After you start recording, and before you finish, you can select up to 3 frames of still images from your movie.

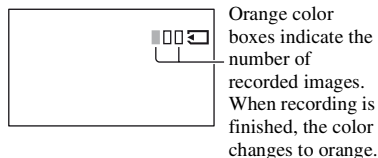



③ Press START/STOP to stop movie recording.

Stored still images appear one by one, and the images are stored onto the "Memory Stick Duo." When  disappears, the image has been recorded.

Notes

- Do not eject the "Memory Stick Duo" before recording is finished and the still images are stored on the "Memory Stick Duo."
- You cannot use the flash during Dual Rec.

💡 Tips

- When the POWER switch is set to  (Movie), the size of still images becomes  2.3M (16:9 wide) or 1.7M (4:3).
- You can record still images during recording standby in the same way as when the POWER switch is set to  (Still). You can also record with the flash.

Recording in dark places (NightShot)

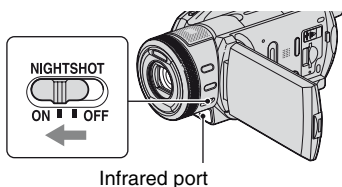

Set the NIGHTSHOT switch to ON. ( appears.)

🌀 Notes

- The NightShot and Super NightShot functions use infrared light. Therefore, do not cover the infrared port with your fingers or other objects, and remove the conversion lens (optional).
- Adjust the focus manually ([FOCUS], p. 90) when it is hard to focus automatically.
- Do not use the NightShot and Super NightShot functions in bright places. This may cause a malfunction.

💡 Tips

- To record an image brighter, use Super NightShot function (p. 93). To record an image more faithfully to the original colors, use Color Slow Shutter function (p. 92).

Adjusting the exposure for backlit subjects

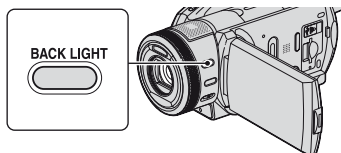

To adjust the exposure for backlit subjects, press BACK LIGHT to display . To cancel the back light function, press BACK LIGHT again.

Recording in mirror mode

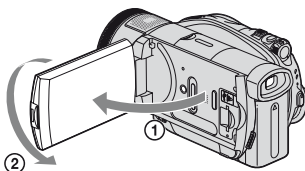

Open the LCD panel 90 degrees to the camcorder (①), then rotate it 180 degrees to the lens side (②).

💡 Tips

- A mirror-image of the subject appears on the LCD screen, but the image will be normal when recorded.

Recording the images (Continued)

Recording the fast action in slow-motion (SMTH SLW REC)

Fast moving subjects and actions, which cannot be captured under the ordinary shooting conditions, can be shot in smooth moving slow-motion for about 3 seconds. This is useful to shoot fast actions such as a golf or tennis swing.

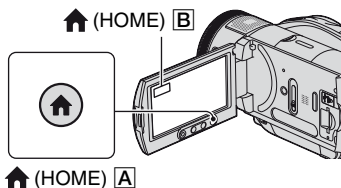

- 1 Slide the POWER switch to turn on the camcorder.
- 2 Press (HOME) [A] (or [B]) to display the HOME MENU.
- 3 Touch (CAMERA).
- 4 Touch [SMTH SLW REC].



- 5 Press START/STOP.
An about 3 second-movie is recorded as a 12 second-slow-motion-movie.
When [Recording...] disappears, recording is finished.

Touch to cancel the smooth slow recording.

To select the start point

The default setting is [3sec AFTER].

- 1 Touch (OPTION) on the [SMTH SLW REC] screen.
- 2 Touch .
- 3 Touch [TIMING].

Select one of the following start points for recording.

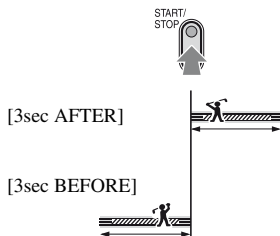

Notes

- Sounds cannot be recorded.

Controlling the image settings manually with the camera control ring

You can assign one menu item you use often to the camera control ring. Since the focus adjustment is assigned to the camera control ring in the default settings, the operation below is described as adjusting the focus using the ring.

Camera control ring

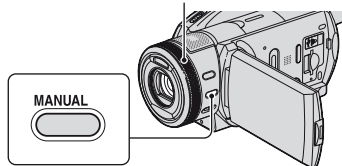

- 1 Press MANUAL to activate the manual adjustment mode.
Pressing MANUAL switches the setting mode between automatic and manual.
- 2 Rotate the camera control ring to adjust the focus.

Items you can assign to the camera control ring

- [FOCUS] (p. 90)
- [EXPOSURE] (p. 91)

- [AE SHIFT] (p. 78)
- [WB SHIFT] (p. 78)

To assign the menu items to the camera control ring

- 1 Press and hold MANUAL for a few seconds.
The [RING SETTING] screen appears.

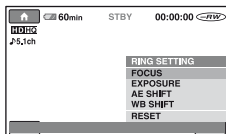

- 2 Rotate the camera control ring and select the item to be assigned.
- 3 Press MANUAL.

💡 Tips

- The functions of the items that can be assigned to the camera control ring are the same as those of menu operation.
- If you select [RESET] while adjusting an item manually, all the items adjusted manually are reset to the default settings.
- You can assign the menu item to the camera control ring in the HOME MENU by selecting  (SETTINGS) → [MOVIE SETTINGS]/[PHOTO SETTINGS] → [RING SETTING] (p. 80).

Viewing the images

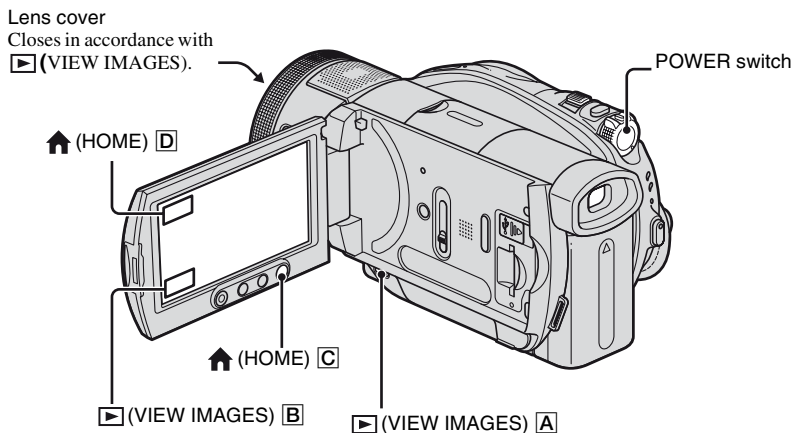

1 Slide the **POWER** switch to turn on your camcorder.

2 Press ▶ (VIEW IMAGES) **A** (or **B**).

The **VISUAL INDEX** screen appears on the LCD screen. (It may take some time to display the **VISUAL INDEX** screen.)

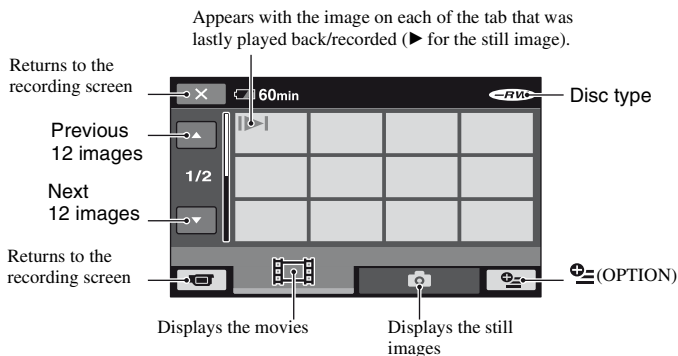

Playing movies

On the VISUAL INDEX screen, touch the  tab and the movie to be played back.

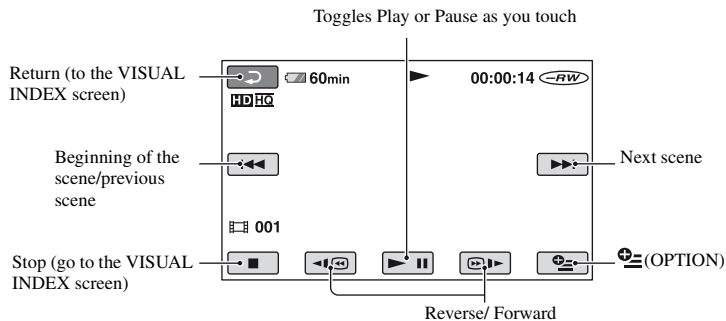



To play back movies slowly

Touch  /  during pause.

To adjust the sound volume

Touch  (OPTION) →  tab → [VOLUME], then adjust the volume with  / .

Tips



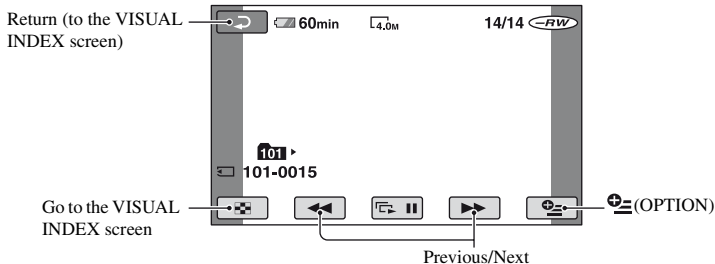

- A touch of  /  makes the reverse/fast forward approximately 5 times faster, 2 touches makes it approximately 10 times faster (Approximately 8 times faster using DVD+RW with SD (standard definition) image quality).
- There is  on the movie you played the last time. If you touch the movie, you can play it back from the point you have stopped.

Viewing still images

On the **VISUAL INDEX** screen, touch the  tab and the still image to be played back.



To switch to the playback mode using the (HOME) button

- ① Press  (HOME)  (or ) when the power of the camcorder is on.
- ② Touch the  (VIEW IMAGES) category on the HOME MENU.
- ③ Touch [VISUAL INDEX].

Using PB zoom

You can magnify still images from about 1.1 to 5 times the original size.

Magnification can be adjusted with the power zoom lever or the zoom buttons below the LCD screen.

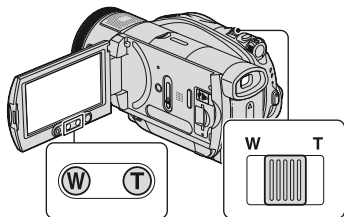

- 1 Play back the still images you want to magnify.
- 2 Magnify the still image with T (Telephoto).
The screen is framed.
- 3 Touch the screen at the point you want to display in the center of the displayed frame.
- 4 Adjust the magnification with W (Wide angle)/T (Telephoto).

To cancel, touch .

Notes

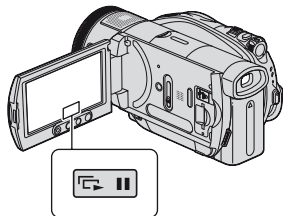

- You cannot change the zoom speed with the zoom buttons below the LCD screen.

Playing back a series of still images (Slide show)



Touch  on the still image playback screen.

The slide show begins from the selected image.

Touch  to stop the slide show. To restart, touch  again.

Tips

- You can set continuous slide show playback using [SLIDE SHOW SET] on  (OPTION). The default setting is [ON] (continuous playback).

Notes

- You cannot operate playback zoom during slide show.

Playing the image on a TV

Connection methods and quality of the image viewed on the TV screen differ depending on what type of TV is connected, and the connectors used.

Use the supplied AC Adaptor as the power source (p. 26).

Refer also to the instruction manuals supplied with the device to be connected.

Operation flow

You can make sure that you are connecting the TV correctly using [TV CONNECT Guide] displayed on the LCD screen.

Switch the input on the TV to the connected jack.

Refer to the instruction manuals of the TV.

↓
Connect your camcorder and TV referring to [TV CONNECT Guide].

↓
Make the required output settings on your camcorder (page 49).

Jacks on your camcorder

Open the jack cover and connect the cable.

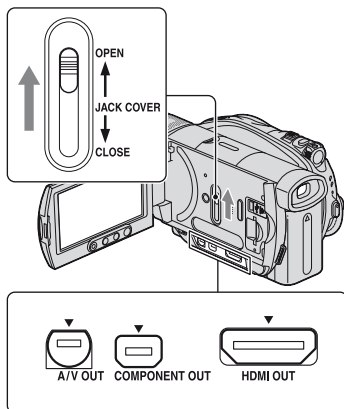

Selecting the most advantageous connection - TV CONNECT Guide

Your camcorder will advise you of the most advantageous way of connecting your TV.

- 1 Turn on your camcorder, and press **HOME**.
- 2 Touch **+>** (SELECT DEVICES).
- 3 Touch [TV CONNECT Guide].
- 4 Touch the option that is right for you on the screen.

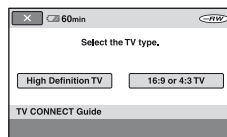

Meanwhile, you can make the relevant connection between your camcorder and the TV.

Connecting to a high definition TV

Images recorded with HD (high definition) image quality are played back with HD (high definition) image quality. Images recorded with SD (standard definition) image quality are played back with SD (standard definition) image quality.

Input jacks on the TV

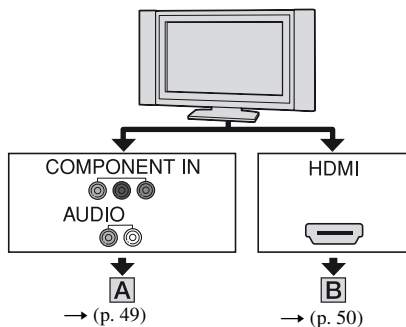

: Signal flow

Type	Camcorder	Cable	TV	HOME MENU setting
------	-----------	-------	----	-------------------

A

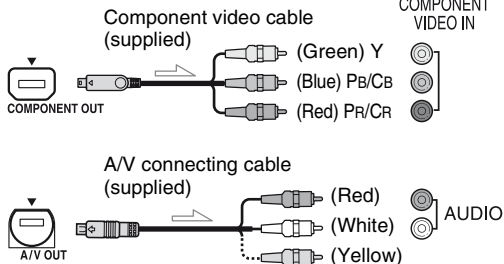

(SETTINGS) →
[OUTPUT SETTINGS] →
→ [COMPONENT] →
[1080i/576i] (p. 86)

Notes

- An A/V connecting cable is also needed to output audio signals. Connect the white and red plugs of the A/V connecting cable to the audio input jack of your TV.

Playing the image on a TV (Continued)

 : Signal flow

Type	Camcorder	Cable	TV	HOME MENU setting
------	-----------	-------	----	-------------------

B

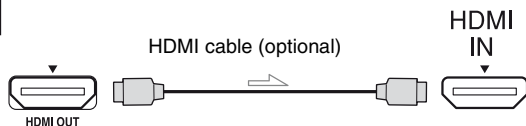

Notes

- Use an HDMI cable with the HDMI logo.
 - Images are not output from the HDMI OUT jack, if copyright protection signals are recorded in the images.
 - Some TVs may not function correctly (e.g., no sound or image) with this connection.
 - Do not connect the HDMI OUT jack of your camcorder and HDMI OUT jack of the external device with the HDMI cable. This may cause a malfunction.
-

Connecting to a non-high-definition 16:9 (wide) or 4:3 TV

Images recorded with HD (high definition) quality is converted to SD (standard definition) and played back. Images recorded with SD (standard definition) image quality are played back with SD (standard definition) image quality.

Input jacks on the TV

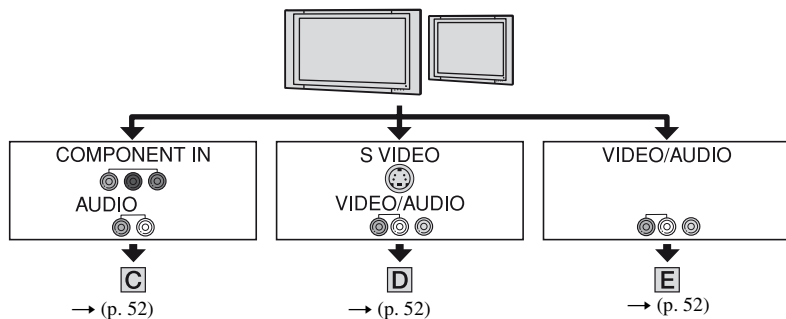

To set the aspect ratio according to the connected TV (16:9/4:3)

Set [TV TYPE] to [16:9] or [4:3] according to your TV (p. 86).

Notes

- When you play back a movie recorded with SD (standard definition) image quality on a 4:3 TV that is not compatible with the 16:9 signal, display the HOME MENU, then select  (SETTINGS) → [MOVIE SETTINGS] → [WIDE SELECT] → [4:3] on your camcorder when recording an image (p. 79).

Playing the image on a TV (Continued)

 : Signal flow

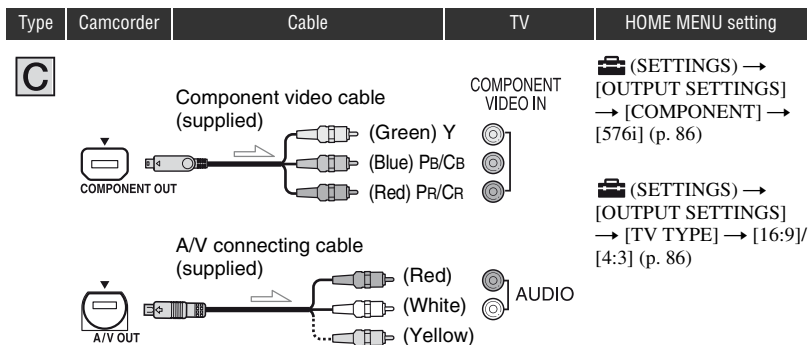

Notes

- An A/V connecting cable is also needed to output audio signals. Connect the white and red plugs of the A/V connecting cable to the audio input jack of your TV.

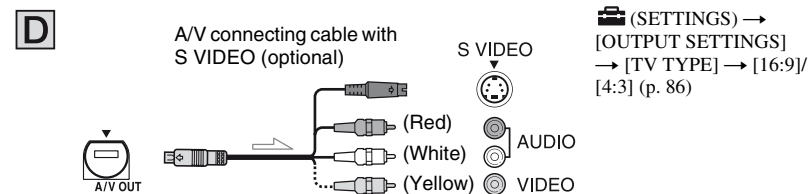

Notes

- When the S VIDEO plug (S VIDEO channel) is connected, audio signals are not output. To output audio signals, connect the white and red plugs of an A/V connecting cable with the S VIDEO cable to the audio input jack of your TV.
- This connection produces higher resolution images compared with the A/V connecting cable (Type **E**).

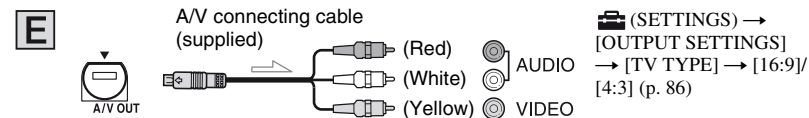

When connecting to your TV via a VCR

Connect your camcorder to the LINE IN input on the VCR using the A/V connecting cable. Set the input selector on the VCR to LINE (VIDEO 1, VIDEO 2, etc.).

When your TV is monaural (When your TV has only one audio input jack)

Connect the yellow plug of the A/V connecting cable to the video input jack and connect the white (left channel) or red (right channel) plug to the audio input jack of your TV or VCR. When you want to play the sound in monaural mode, use a connecting cable for that purpose.

If your TV/VCR has a 21-pin adaptor (EUROCONNECTOR)

Use a 21-pin adaptor (optional) to view playback images.

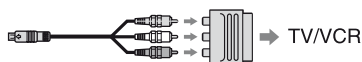

🔊 Notes

- When you output images using the A/V connecting cable, images are output with SD (standard definition) image quality.

💡 Tips

- If you connect your camcorder to your TV using more than one type of cable to output images, the order of priority of the output signal is as follows:
HDMI → component video → S VIDEO → audio/video.
- HDMI (High Definition Multimedia Interface) is an interface to send both video/audio signals. The HDMI OUT jack outputs high quality images and digital audio.

(OTHERS) category

This category enables you to edit the images on a disc or a “Memory Stick Duo.”



 (OTHERS) category

Item list

EDIT

You can edit the images on a disc or a “Memory Stick Duo” (p. 54, 55).

PLAYLIST EDIT

You can create and edit a Playlist (p. 57).

PRINT

You can print still images on a connected PictBridge printer (p. 63).

Deleting images

You can delete the images recorded on a disc or a “Memory Stick Duo” using your camcorder.

Insert a recorded disc or “Memory Stick Duo” into your camcorder.

Deleting the movies on the disc



- 1 Turn on your camcorder, then press  (HOME).

- 2 Touch  (OTHERS) → [EDIT].

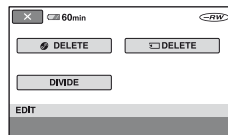

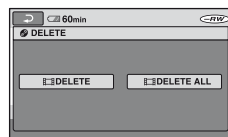

- 3 Touch [] DELETE].



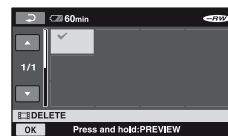

- 4 Touch [] DELETE].

- 5 Touch the image to be deleted.



The selected scene is marked with .

Press and hold the image on the LCD screen to confirm the image.
Touch  to return to the previous screen.

6 Touch  → [YES] → .

To delete all movies on the disc at one time

In step 4, touch  [DELETE ALL] → [YES] → [YES] → .

Notes

- Images cannot be restored once they are deleted.
- Do not remove the battery pack or the AC Adaptor from your camcorder while editing images. It may damage the disc.
- You can do this operation only with DVD-RW (VR mode) for the SD (standard definition) image quality.
- If the deleted movie is included in the Playlist (p. 57), the movie is deleted also from the Playlist.
- Even if you delete unnecessary images from the disc, the remaining disc capacity may not increase as much as you can make additional recording.
- To delete all images recorded in the disc and restore the original capacity of the disc, format the disc (page 72).

Tips

- You can select up to 100 images at one time.
- You can delete an image when viewing it using [DELETE] on  (OPTION).

Deleting the still images in the “Memory Stick Duo”

1 Turn on your camcorder, then press  (HOME).

2 Touch  (OTHERS) → [EDIT].

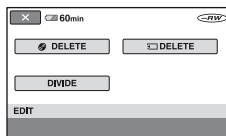

3 Touch  [DELETE].

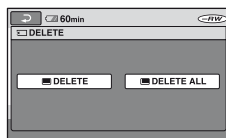

4 Touch  [DELETE].

5 Touch the still image to be deleted.



The selected still image is marked with ✓.

Press and hold the still image on the LCD screen to confirm the still image.

Touch  to return to the previous screen.

6 Touch **[OK]** → **[YES]** → **[OK]**.

To delete all still images on the “Memory Stick Duo”

In step **4**, touch **[DELETE ALL]** → **[YES]** → **[YES]** → **[OK]**.

Notes

- You cannot restore still images once they are deleted.
- You cannot delete still images when a “Memory Stick Duo” with the write-protect tab is set to the write-protect position (p. 128), or when the selected image is protected.

Tips

- You can select up to 100 still images at one time.
- You can delete a still image when viewing it using **[DELETE]** on **[OPTION]**.
- To delete all images recorded on the “Memory Stick Duo,” format the “Memory Stick Duo” (p. 73).

Dividing the image

DVD
-RW

DVD
+RW

1 Turn on your camcorder, then press **↑** (**HOME**).

2 Touch **[OTHERS]** → **[EDIT]**.

3 Touch **[DIVIDE]**.

4 Touch the movie to be divided.

The movie pauses.

5 Touch **[II]** at the point where you want to divide the movie into the scenes.

The movie pauses.

Returns to the beginning of the selected movie.



Adjusts the dividing point more precisely after the dividing point has been selected with **[II]**.

Play and pause toggles as you press



To adjust the volume, touch **[OPTION]** → **[VOLUME]**.

6 Touch **[OK]** → **[YES]** → **[OK]**.

Creating the Playlist



Notes

- Movies cannot be restored once they are divided.
- Do not remove the battery pack or the AC Adaptor from your camcorder while editing images. It may damage the disc.
- You can do this operation only with DVD-RW (VR mode) for the SD (standard definition) image quality.
- Even if the divided movie is included in the Playlist, the movie is not divided in the Playlist.
- A slight difference may occur from the point where you touch and the actual dividing point, as your camcorder selects the dividing point based on about half-second increments.

A Playlist is a list showing thumbnails of the movies that you have selected. The original scenes are not changed even though you edit or delete the scenes in the Playlist.

Playlist Glossary (p. 147)

Make sure to insert the recorded disc into your camcorder.

Notes

- You can do this operation only with DVD-RW (VR mode) for the SD (standard definition) image quality.

1 Turn on your camcorder, then press (HOME).

2 Touch (OTHERS) → [PLAYLIST EDIT].

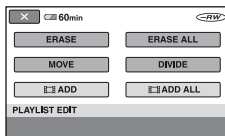

3 Touch [ADD].

4 Touch the scene to be added to the Playlist.



The selected scene is marked with . Press and hold the image on the LCD screen to confirm the image.

Touch to return to the previous screen.

5 Touch **[OK]** → **[YES]** → **[OK]**.

To add all the movies on the disc in the Playlist

In step **3**, touch **[ADD ALL]** → **[YES]** → **[YES]** → **[OK]**.

Notes

- Do not remove the battery pack or the AC Adaptor from your camcorder while editing the Playlist. It may damage the disc.

Tips

- You can add a maximum of 999 movies to the Playlist.
- You can add a movie when viewing it using **[ADD]** on **[OPTION]**.

Playing the Playlist

Make sure to insert the disc on which the Playlist is added into your camcorder.

1 Turn on your camcorder, then press **[HOME]**.

2 Touch **[VIEW IMAGES]** → **[PLAYLIST]**.

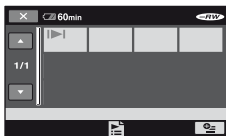

3 Touch the scene from which you want to play back.

The Playlist is played back from the selected scene to the end, then the screen returns to the Playlist screen.

Erasing unnecessary scenes from the Playlist

1 Turn on your camcorder, then press **[HOME]**.

2 Touch **[OTHERS]** → **[PLAYLIST EDIT]**.

3 Touch **[ERASE]**.

4 Select the scene to be deleted from the list.



The selected scene is marked with **✓**. Press and hold the image on the LCD screen to confirm the image.

Touch **[RETURN]** to return to the previous screen.

5 Touch **[OK]** → **[YES]** → **[OK]**.

To erase all the scenes from the Playlist

In step 3, touch [ERASE ALL] → [YES] → [YES] → [OK].

💡 Tips

- The original scenes are not changed even if you erase the scenes from the Playlist.

Changing the order within the Playlist

1 Turn on your camcorder, then press  (HOME).

2 Touch  (OTHERS) → [PLAYLIST EDIT].

3 Touch [MOVE].

4 Select the scene to be moved.



The selected scene is marked with ✓. Press and hold the image on the LCD screen to confirm the image. Touch  to return to the previous screen.

5 Touch [OK].

6 Select the destination with [←]/ [→].

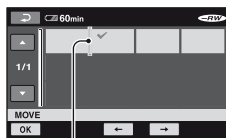

Destination bar

Press and hold the image on the LCD screen to confirm the image.

7 Touch [OK] → [YES] → [OK].

💡 Tips

- When you select multiple scenes, the scenes are moved following the order appeared in the Playlist.

Dividing a movie within the Playlist

1 Turn on your camcorder, then press  (HOME).

2 Touch  (OTHERS) → [PLAYLIST EDIT].

3 Touch [DIVIDE].

4 Select the scene to be divided.

The playback of the selected scene starts.

5 Touch at the point where you want to divide the movie into scenes.

The movie pauses.

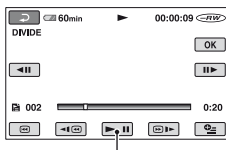

Play and pause toggles as you press



6 Touch → [YES] → .

Notes

- A slight difference may occur from the point where you touch  and the actual dividing point, as your camcorder selects the dividing point based on about half-second increments.

Tips

- The original movies are not changed even if you divide the movie in the Playlist.

(SELECT DEVICES) category

This category enables you to utilize your camcorder connected to other devices.



 (SELECT DEVICES) category

Item list

COMPUTER

Your camcorder can be connected to your computer (p. 96).

TV CONNECT Guide

Your camcorder advises you of the most advantageous way of connecting your TV to view images on the TV (p. 48).

PRINTER

You can print still images on a connected PictBridge printer (p. 63).

Dubbing a disc

By connecting your camcorder to a VCR, DVD/HDD recorder, or a computer, you can dub a disc.

Notes

- If you want to play back discs on the most currently available DVD devices, create discs by dubbing so that the image quality is converted to SD (standard definition).
- An image recorded with SD (standard definition) image quality cannot be converted to HD (high definition) image quality.

Quality of dubbed images by connecting other devices

When dubbing the images on the disc to another VCR or DVD/HDD recorder (p. 62).

Image quality of recorded images		Image quality of dubbed images
HD	→	SD
SD	→	SD

Quality of dubbed images by copying in a computer

“Picture Motion Browser” on the CD-ROM (supplied) must be installed on the computer (p. 98).

Image quality of recorded images		Image quality of created discs
HD	→	HD or SD
SD	→	SD

To copy the entire disc

Use “Disc Copier” on the CD-ROM (supplied).

Image quality of recorded images		Image quality of created discs
HD	→	HD or SD
SD	→	SD

HD: High definition

SD: Standard definition

Dubbing to VCR or DVD/HDD recorders

You can dub images played back on your camcorder to other recording devices, such as VCRs or DVD/HDD recorders. Connect the device in either of the following ways.

Connect your camcorder to the wall socket using the supplied AC Adaptor for this operation (p. 26). Refer also to the instruction manuals supplied with the devices to be connected.

⚡ Notes

- **Movies recorded with HD (high definition) image quality will be dubbed with SD (standard definition) image quality.**
- Since dubbing is performed via analog data transfer, the image quality may deteriorate.
- To copy a disc recorded with HD (high definition) image quality, install the application software (supplied) on your computer (p. 98), and copy the images to a disc in the computer.

A/V OUT jack

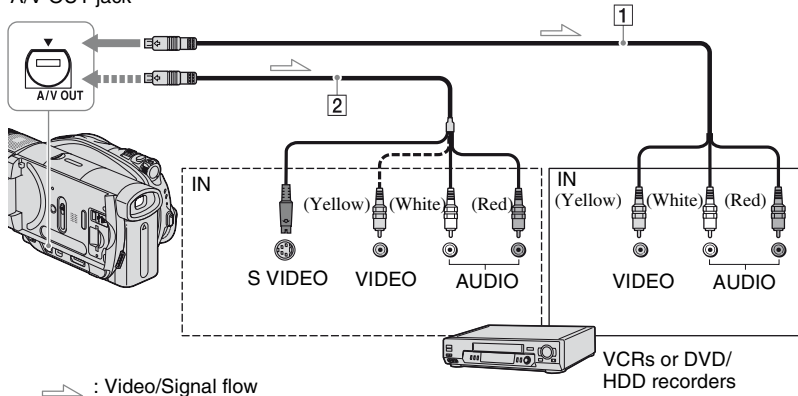

1 A/V connecting cable (supplied)

Connect to the input jack of the other device.

2 A/V connecting cable with S VIDEO (optional)

When connecting to another device via the S VIDEO jack, by using an A/V connecting cable with an S VIDEO cable (optional), higher quality images can be produced than with an A/V connecting cable. Connect the white and red plug (left/right audio) and the S VIDEO plug (S VIDEO channel) of the A/V connecting cable with an S VIDEO cable (optional). The yellow plug (S VIDEO channel) of the A/V connecting cable with an S VIDEO connection is not necessary. S VIDEO connection only will not output audio.

⚡ Notes

- You cannot dub to recorders connected with an HDMI cable.
- To hide the screen indicators (such as a counter, etc.) on the screen of the monitor device connected, set (SETTINGS) → [OUTPUT SETTINGS] → [DISP OUTPUT] → [LCD PANEL] (the default setting) on the HOME MENU (p. 86).
- To record the date/time and camera settings data, display them on the screen (p. 84).
- When you are connecting your camcorder to a monaural device, connect the yellow plug of the A/V connecting cable to the video input jack, and the red (right channel) or the white (left channel) plug to the audio input jack on the device.

1 Insert the recorded disc into your camcorder.

2 Turn on your camcorder, and press **[VIEW IMAGES]**.

Set [TV TYPE] according to the display device (p. 86).

3 Insert the recording media in the recording device.

If your recording device has an input selector, set it to the input mode.

4 Connect your camcorder to the recording device (VCR or DVD/HDD recorder) with the A/V connecting cable (supplied) **[1]** or an A/V connecting cable with S VIDEO (optional) **[2]**.

Connect your camcorder to the input jacks of the recording device.

5 Start the playback on your camcorder, and record it on the recording device.

Refer to the instruction manuals supplied with your recording device for details.

6 When dubbing is finished, stop the recording device, and then your camcorder.

Printing recorded images (PictBridge compliant printer)

You can print out still images using a PictBridge compliant printer, without connecting the camcorder to a computer.

PictBridge

Connect your camcorder to the AC Adaptor to obtain power from the wall socket (p. 26).

Insert the “Memory Stick Duo” containing still images into your camcorder and turn on the printer.

Connecting your camcorder to the printer

1 Turn on your camcorder.

2 Connect the  (USB) jack of your camcorder to the printer using the USB cable (p. 140).

[USB SELECT] appears on the screen automatically.

3 Touch **[PRINT]**.

When connection is complete,  (PictBridge connecting) appears on the screen.

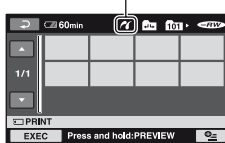

One of the still images stored on the “Memory Stick Duo” will be displayed.

Notes

- We can guarantee the operation of only models that are PictBridge compatible.

Printing

1 Touch the still image to be printed.



The selected image is marked with ✓.

Press and hold the image on the LCD screen to confirm the image.

Touch  to return to the previous screen.

2 Touch (OPTION), set the following options, then touch .

[COPIES]: Set number of copies of a still image to be printed. You can set up to 20 copies.

[DATE/TIME]: Select [DATE], [DAY&TIME], or [OFF] (no date/time printed).



[SIZE]: Select the paper size.

If you do not change the setting, go to step 3.

3 Touch [EXEC] → [YES] → .

The image selection screen appears again.

Notes

- Refer also to the instruction manual of the printer to be used.
- Do not attempt the following operations when  is on the screen. The operations may not be performed properly.
 - To operate the POWER switch.
 - To press  (VIEW IMAGES)
 - To disconnect the USB cable from the printer.
 - To remove the “Memory Stick Duo” from your camcorder
- If the printer stops working, disconnect the USB cable, turn the printer off and on again, and restart the operation from the beginning.
- You can select only the paper sizes that the printer can print.
- On some printer models, the top, bottom, right, and left edges of images may be trimmed. If you print a still image recorded in a 16:9 (wide) ratio, the left and right ends of the image may be trimmed widely.
- Some printer models may not support the date printing function. Refer to your printer’s instruction manual for details.
- We cannot guarantee the printing of images recorded with a device other than your camcorder.
- You cannot print still images that have a file size larger than 2 MB or 2304 × 1728 pixels, recorded by other devices.

Tips

- PictBridge is an industry standard established by the Camera & Imaging Products Association (CIPA). You can print still images without using a computer by connecting a printer directly to a digital video camera or digital still camera, regardless of model or manufacturer.
- You can print a still image when viewing it using [PRINT] on  (OPTION).

To finish printing

Touch  on the image selection screen.

(MANAGE DISC/MEMORY) category

This category enables you to use a disc or a “Memory Stick Duo” for various purposes.



 (MANAGE DISC/MEMORY) category

Item list

FINALIZE

You can enable discs to be played on other devices by finalizing them (p. 66).

DISC SELECT GUIDE

Your camcorder advises you of the right disc for your purpose (p. 71).

FORMAT

You can format and use the disc again (p. 72).

FORMAT

You can format and use the “Memory Stick Duo” again (p. 73).

UNFINALIZE

You can unfinalize a disc and record more images on it (p. 74).

DISC INFO

You can display the disc information (p. 75).

Making the disc compatible with playback on other devices or DVD drives (Finalizing)

Finalizing makes the recorded disc compatible for playback with other devices and DVD drives of computers.

During finalizing, you can select the disc menu type to view disc contents (p. 68).

Notes

- Playback compatibility with all device is not guaranteed.
- Only the devices compatible with the AVCHD format can play the discs recorded with HD (high definition) image quality (p. 70). Currently available DVD devices cannot play these discs.

Discs recorded with HD (high definition) image quality

Discs of all kinds should be finalized.

Discs recorded with SD (standard definition) image quality

- Finalize DVD-R/DVD+R DL/DVD-RW.
- Finalize DVD+RW in the following cases:
 - To create the DVD menu
 - To playback in the DVD drives of computers
 - Recorded time is short (5 minutes or less in HQ mode, 8 minutes or less in SP mode and 15 minutes or less in LP mode)

Notes

- In the case of SD (standard definition) image quality, a DVD menu is created instead of a disc menu.
- No DVD menu is created for DVD-RW (VR mode).

Operation flow

The following operations are for the discs recorded with HD (high definition) image quality.

To play back a disc on another device for the first time (p.68)

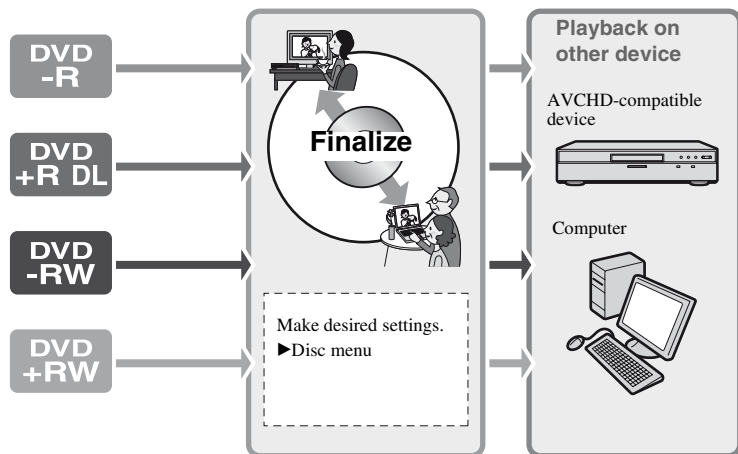

To add recordings to a finalized disc (p. 74)

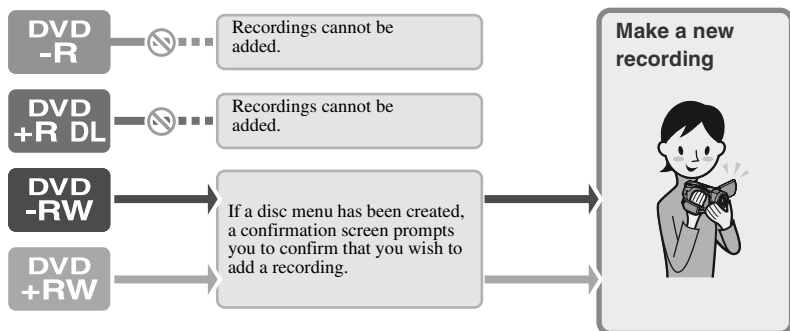

Making the disc compatible with playback on other devices or DVD drives (Finalizing) (Continued)

 To play back a disc on another device after adding a recording (p.68)

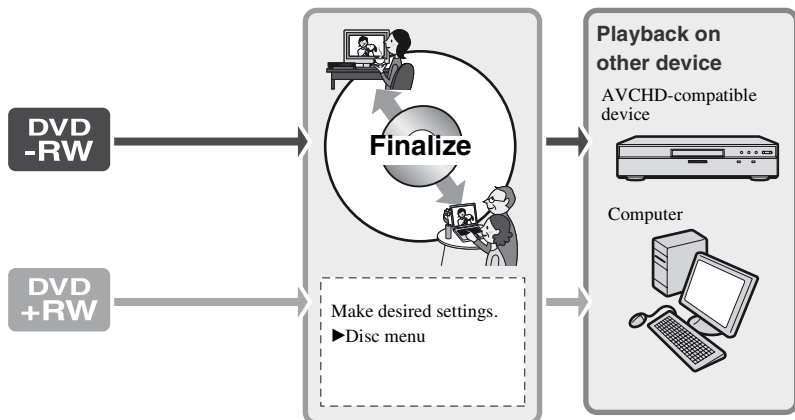

Finalizing a disc

🔊 Notes

- It takes from a minute to a maximum of several hours to finalize a disc. The shorter the amount of material recorded on the disc, the longer it takes for finalizing.
- Use the AC Adaptor as the power source to prevent your camcorder from running out of power during finalizing.
- When you finalize a double-sided disc, you must finalize each side of the disc individually.

1 Place your camcorder in a stable position, and connect the AC Adaptor to the DC IN jack on your camcorder.

2 Turn on the power by sliding the POWER switch.

3 Insert the disc to be finalized.

4 Press  (HOME).

5 Touch  (MANAGE DISC/MEMORY) → [FINALIZE].

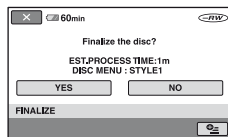

To select a disc menu style, touch  (OPTION) → [DISC MENU] (p. 69).





Go to step **6** if you want to finalize the disc using [STYLE1] (default setting).
Disc menu  Glossary (p. 146)

6 Touch [YES] → [YES].

Finalizing starts.







7 When [Completed.] appears, touch [OK].

Notes

- Do not apply shock or vibration to your camcorder, and do not disconnect the AC Adaptor during finalizing. When you need to disconnect the AC Adaptor, make sure that the power of your camcorder is set to off and disconnect the AC Adaptor after the  (Movie) or  (Still) lamp goes off. Finalizing restarts when you connect the AC Adaptor and turn on your camcorder again. You cannot remove the disc until the finalizing operation is completed.
- When using the following discs,   flashes after finalizing is completed on the recording standby screen of your camcorder. Remove the disc from your camcorder.
 - Discs recorded with HD (high definition) image quality
 - Discs recorded with SD (standard definition) image quality, except DVD-RW (VR mode)

Tips

- When you set to create a disc menu (or DVD menu) and finalize the disc, the disc menu appears for a few seconds while finalizing the disc.
- After the disc is finalized, the disc type/recording format indicator changes as shown below:

DVD-R	
DVD+R DL	
DVD+RW	
DVD-RW (HD (high definition) image quality)	
DVD-RW (SD (standard definition) image quality) (VIDEO mode)	
DVD-RW (SD (standard definition) image quality) (VR mode)	

To select a disc menu style

- In step 4, touch  (OPTION) → [DISC MENU].
- Select the desired style from 4 types of pattern with [←]/[→].

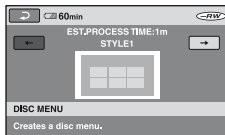

Select [NO MENU] if you do not create a disc menu.

- Touch [OK].

Notes

- You cannot do this operation with DVD-RW (VR mode) for the SD (standard definition) image quality.

Playing a disc on other devices

Playing a disc on other devices

The kind of device you can play a disc on depends on the image quality (HD (high definition) or SD (standard definition)) selected when the disc was recorded. For details, refer to the instruction manual supplied with your device.

Discs recorded with HD (high definition) image quality

You can play back these discs only on devices compatible with the AVCHD format.

Since DVD players and DVD recorders are incompatible with the AVCHD format, they cannot play discs recorded with HD (high definition) image quality.

Also, if you insert an HD (high definition) image quality disc recorded in the AVCHD format in these devices, you may not be able to eject the disc.

If you have inserted a disc recorded in the AVCHD format in a DVD device, there is a risk that you can neither record nor play back the disc correctly on your camcorder.

Discs recorded with SD (standard definition) image quality

You can play these discs back on DVD devices. However, we do not guarantee playback on all DVD devices.

Notes

- Do not use an 8 cm CD adaptor with an 8 cm DVD as it may cause a malfunction.
- Make sure that a vertically installed device is placed in a position such as that the disc can be placed horizontally.
- Refer to the instruction manual supplied with your device or consult your dealer.
- Some discs cannot be played back, may freeze for an instant between scenes. Some functions may be disabled on some devices.

Tips

- Devices that support subtitles can display the recording date and time where the subtitles normally appear (p. 80). Refer to the instruction manual of your device.
- If you have created a disc menu (p. 68), you can select the desired scene in the menu.
- You can also play the playlist back on other devices if the discs were recorded with HD (high definition) image quality (p. 57). Create the playlist on your camcorder in advance, then select  on the disc menu.

Playing a disc on a computer

Notes

- Make sure that the DVD drive of the computer can play an 8 cm DVD.
- Do not use an 8 cm CD adaptor with an 8 cm DVD as it may cause a malfunction.
- You must finalize the disc (p. 66). Otherwise, a malfunction may occur.

To play a disc recorded with HD (high definition) image quality

Install “Picture Motion Browser” on the supplied CD-ROM on the computer to play movies (p. 98).

Tips

- For details on operations and procedures, see the “First Step Guide” on the supplied CD-ROM (p. 101).

To play a disc recorded with SD (standard definition) image quality

You can play a disc on a computer if a DVD playback application is installed on the computer.

- ① Insert the finalized disc into the DVD drive of your computer.
- ② Play back the disc using a DVD playback application.

Notes

- The disc may not be played back, or the movies may not be played smoothly on some computers.
- You cannot play back or edit movies that have been copied from the disc to the hard disk of your computer directly. For details on how to import movies, refer to the “First Step Guide” on the supplied CD-ROM.

The volume label of the disc recorded with SD (standard definition) image quality

The date when the disc was first used is recorded.

<e.g.>

When the disc was first used at 6:00 pm on January 1st 2006:

2006_01_01_06H00M_PM

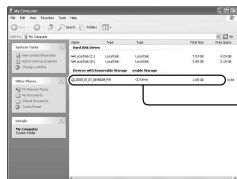

Volume label

Tips

- Images in discs recorded with SD (standard definition) image quality are stored in the following folders:
 - DVD-RW (VR mode) DVD_RTAV folder
 - Other discs and modes VIDEO_TS folder

Finding the right disc - DISC SELECT GUIDE

Select the option that is right for you on the screen, then you will be informed of the appropriate disc for your purposes.

1 Turn on your camcorder, and press **HOME**.

2 Touch **MANAGE DISC/MEMORY**.



3 Touch **[DISC SELECT GUIDE]**.

4 Touch the option that is right for you on the screen.

When you answer all the questions, you will be informed of the right disc for you.

When you insert the same type of disc as that indicated in the results of the guide, the disc is formatted with the options you selected.

Tips

- You can refer to “Selecting the right disc” in the supplied “Read This First,” as well.

Deleting all scenes on the disc (Formatting)

Formatting the disc



DVD
-RW

DVD
+RW



Formatting makes the recorded disc new and reusable by deleting all the data recorded on the disc. The recording capacity of the disc is recovered by formatting it.

A DVD-R/DVD+R DL cannot be formatted. Replace it with a new disc.

If you format a finalized disc

Formatting deletes all images on a finalized disc. One of the following icons,  or , appears on the screen, but there is no need to finalize the disc again before playing the disc on an AVCHD format compatible player.*

When formatting a disc of the SD (standard definition) image quality

- In the case of a DVD-RW (VIDEO mode), the disc is unfinalized and it has to be finalized again to enable the disc to be played on another device.
- In the case of a DVD-RW (VR mode)/DVD+RW, formatting deletes all images on a finalized disc. One of the following icons,  or , appears on the screen, but there is no need to finalize the disc again before playing the disc on other devices.*



* To create a disc menu (DVD menu) on a DVD+RW, finalize the disc again (p. 66).

1 Connect the AC Adaptor to the DC IN jack on your camcorder, then connect the mains lead to the wall socket.

2 Turn on your camcorder.

3 Insert the disc to be formatted into your camcorder.

4 Press  (HOME).

5 Touch  (MANAGE DISC/MEMORY) → [ FORMAT].

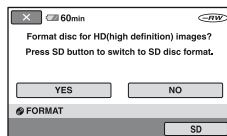

Notes

- The screen message will be different if the disc was formatted with SD (standard definition) image quality at the previous formatting. Follow the procedures on the screen.

6 Touch [YES].

To record with SD (standard definition) image quality, touch [SD].

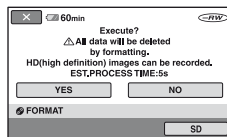

Notes

- You cannot change the recording format of a disc midway.
- For details on AVCHD format/DVD format, see page 14.

7 Touch the option that is right for you on the screen.

The disc will be formatted in the recording image quality and mode you selected.

When the disc is formatted, you can start recording on the disc.

To format a disc with SD (standard definition) image quality

- Select the recording format, VIDEO mode or VR mode, for DVD-RW (p. 17).
- Select the aspect ratio, [16:9 WIDE] or [4:3], for DVD+RW.

Notes

- Use the AC Adaptor as the power source to prevent your camcorder from running out of power during formatting.
- Do not apply shock or vibration to your camcorder, and do not disconnect the AC Adaptor during formatting.
- When you use a double-sided disc, formatting is required on each side. You can format each side in the different recording image quality and mode.
- In the case of DVD+RW with SD (standard definition), you cannot change the movie aspect ratio midway. Format the disc again to change the aspect ratio.
- You cannot format a disc that has been protected on other devices. Cancel the protection with the original device, and then format it.

Formatting the “Memory Stick Duo”

Formatting deletes all images on a “Memory Stick Duo.”

1 Turn on your camcorder.

2 Insert the “Memory Stick Duo” to be formatted into your camcorder.

3 Press **HOME**.

4 Touch **MANAGE DISC/MEMORY** → [**FORMAT**].

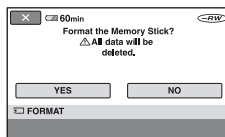

5 Touch [**YES**] → [**YES**].

6 When [**Completed.**] appears, touch [**OK**].

Notes

- Even the still images protected with another device against accidental deletion are also deleted.
- Do not attempt the following operations when [Executing...] is on the screen:
 - To operate the POWER switch or buttons
 - To remove the “Memory Stick Duo”

Recording additional scenes after finalizing (Unfinalize)



You can record additional material on the finalized DVD-RWs/DVD+RWs after the following steps, if there is space to record on the disc.

Notes

- Use the AC Adaptor as power source to prevent your camcorder from running out of power during the operation.
- Do not apply shock or vibration to your camcorder, and do not disconnect the AC Adaptor during the operation.
- A disc menu created during finalizing are deleted.
- When you use a double-sided disc, unfinalize each side.

1 Connect the AC Adaptor to the DC IN jack on your camcorder, then connect the mains lead to the wall socket.

2 Slide the POWER switch to turn on the  (Movie) lamp.

3 Insert the finalized disc into your camcorder.

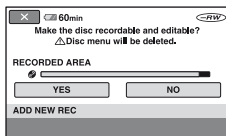

A confirmation screen appears to prompt you to confirm that you wish to record additional scenes.



4 Touch [YES] → [YES].

5 When [Completed.] appears, touch .

For the discs recorded with SD (standard definition) image quality

- When using the finalized DVD-RW (VR mode) disc, you can record additional material on the disc without any additional steps.
- To unfinalize the DVD-RW (VIDEO mode), perform  (MANAGE DISC/MEMORY) → [UNFINALIZE] in the HOME MENU.
- If you have created a DVD menu (p. 68) when finalizing the DVD+RW, a dialog appears to confirm that you wish to record additional scenes when you slide the POWER switch to turn on the  (Movie) lamp.

Notes

- You cannot unfinalize and record additional scenes on the DVD-R/DVD+R DL.

Checking the disc information

1 Turn on your camcorder, then press **↑** (HOME).

2 Touch **MANAGE DISC/MEMORY** → [DISC INFO].

If the item is not on the screen, touch **▲**/**▼** to change the page.

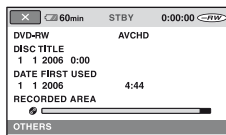

Following information is displayed.

- Media type
- Recording format
- Disc title
- Date and time of the first use of the disc
- Recorded area

To turn off the display

Touch **×**.

💡 Tips

- Image ratio is also displayed for DVD+RW with SD (standard definition) image quality.

What you can do with the (SETTINGS) category of the HOME MENU

You can change the recording functions and the operating settings for your convenience.

Using the HOME MENU

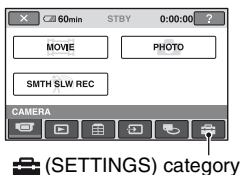
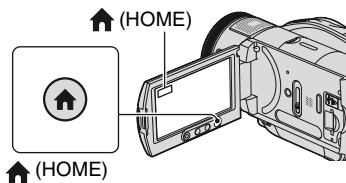

- 1 Turn on your camcorder, then press  (HOME).

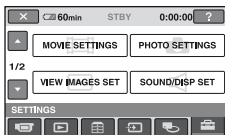

- 2 Touch  (SETTINGS).



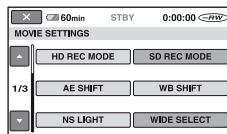

- 3 Touch the desired setup item.

If the item is not on the screen, touch  /  to change the page.



- 4 Touch the desired item.

If the item is not on the screen, touch  /  to change the page.

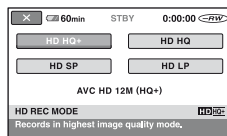

- 5 Change the setting, then touch .

List of the (SETTINGS) category items

MOVIE SETTINGS (p. 78)



Items	Page
HD REC MODE	78
SD REC MODE	78
AE SHIFT	78
WB SHIFT	78
NS LIGHT	79
WIDE SELECT	79
DIGITAL ZOOM	79
STEADYSHOT	79
EXP.FOCUS	79
GUIDEFRA	80
ZEBRA	80
 REMAINING	80
SUB-T DATE	80
RING SETTING	80

PHOTO SETTINGS (p. 81)

Items	Page
 IMAGE SIZE	81
 QUALITY	83
FILE NO.	83
AE SHIFT	78
WB SHIFT	78
NS LIGHT	79
EXP.FOCUS	79
GUIDEFRA	80
ZEBRA	80
FLASH LEVEL	83
REDEYE REDUC	83
RING SETTING	80

VIEW IMAGES SET (p. 84)

Items	Page
VOLUME	84
DATA CODE	84

SOUND/DISP SET (p. 85)

Items	Page
BEEP	85
LCD BRIGHT	85
LCD BL LEVEL	85
LCD COLOR	85
VF B.LIGHT	85

OUTPUT SETTINGS (p. 86)

Items	Page
TV TYPE	86
DISP OUTPUT	86
COMPONENT	86

CLOCK/ LANG (p. 87)

Items	Page
CLOCK SET	31
AREA SET	87
SUMMERTIME	87
 LANGUAGE SET	87

GENERAL SET (p. 87)

Items	Page
DEMO MODE	87
REC LAMP	87
CALIBRATION	132
A.SHUT OFF	88
REMOTE CTRL	88

MOVIE SETTINGS

(Items for recording movies)

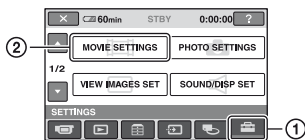

Touch ①, then ②.

If the item is not on the screen, touch ▲/▼ to change the page.

How to set

🏠 (HOME MENU) → page 76

☰ (OPTION MENU) → page 88

The default settings are marked with ▶.

HD REC MODE



You can select a recording mode to record a movie with HD (high definition) image quality from 4 levels.

HD HQ+

Records in the highest quality mode.
(AVC HD 12M (HQ+))

HD HQ

Records in high quality mode.
(AVC HD 9M (HQ))

▶ HD SP

Records in standard quality mode.
(AVC HD 7M (SP))

HD LP

Increases the recording time (Long Play).
(AVC HD 5M (LP))

🔔 Notes

- If you record in the LP mode, details in scenes with quick movements may appear rough when you play the disc back.

💡 Tips

- See page 15 on the expected recording time of each recording mode.

SD REC MODE



You can select a recording mode to record a movie with SD (standard definition) image quality from 3 levels.

SD HQ

Records in high quality mode.
(SD 9M (HQ)).

▶ SD SP

Records in standard quality mode.
(SD 6M (SP)).

SD LP

Increases the recording time (Long Play).
(SD 3M (LP))

🔔 Notes

- If you record in the LP mode, the quality of scenes may be degraded, or scenes with quick movements may appear with a block noise when you play back the disc.

💡 Tips

- See page 15 on the expected recording time of each recording mode.

AE SHIFT



Select [ON] to adjust the exposure using (dark)/ (bright). [AS] and the setting value appear when [AE SHIFT] is anything other than the default setting.

💡 Tips

- Touch if the subject is white or the backlight is bright, or touch if the subject is black or the light is dim.
- You can adjust the automatic exposure level to brighter or darker when [EXPOSURE] is set to [AUTO].
- You can also adjust the setting manually using the camera control ring (p. 42).

WB SHIFT (White Balance Shift)



Select [ON] to adjust the white balance to the desired setting using /.

WB and the setting value appear when [WB SHIFT] is anything other than the default setting.

Tips

- When the white balance is set to a lower value, images appear bluish, and when set to a higher value, images appear reddish.
- You can also adjust the setting manually using the camera control ring (p. 42).

NS LIGHT (NightShot Light)

When using either the NightShot (p. 41) or [SUPER NS] (p. 93) function to record, you can record clearer images by setting [NS LIGHT], which emits infrared light (invisible), to [ON] (the default setting).

Notes

- Do not cover the infrared port with your fingers or other objects (p. 41).
- Remove the conversion lens (optional).
- The maximum shooting distance using [NS LIGHT] is about 3 m (10 feet).

WIDE SELECT

When recording with SD (standard definition) image quality, you can select the aspect ratio according to the TV connected. Refer also to the instruction manuals supplied with your TV.

▶ 16:9 WIDE

Records images to the full screen on a 16:9 (wide) TV screen.

4:3

Records images to the full screen on a 4:3 TV screen.

Notes

- Set [TV TYPE] correctly according to the TV connected for playback (p. 86).
- You cannot change the aspect ratio on a DVD+RW midway.

DIGITAL ZOOM

You can select the maximum zoom level in case you want to zoom to a level greater than 10 × (the default setting) during recording. Note that the image quality decreases when you use the digital zoom.

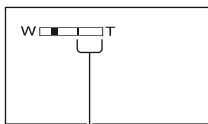

The right side of the bar shows the digital zooming factor. The zooming zone appears when you select the zooming level.

▶ OFF

Up to 10 × zoom is performed optically.

20 ×

Up to 10 × zoom is performed optically, and after that, up to 20 × zoom is performed digitally.

80 ×

Up to 10 × zoom is performed optically, and after that, up to 80 × zoom is performed digitally.

STEADYSHOT

You can compensate for camera shake (the default setting is [ON]). Set [STEADYSHOT] to [OFF] () when using a tripod (optional), then the image becomes natural.

EXP.FOCUS (Expanded focus)

Select [ON] so that the image on the screen is magnified by about 2 times when adjusting focus manually (p. 90). The screen returns to the original size automatically when the focusing is finished. Touch [OFF] to release this function.

MOVIE SETTINGS (Continued)

Notes

- You cannot activate this function during recording.
- The function is released if you use the zoom function.

GUIDEFAME

You can display the frame and check that the subject is horizontal or vertical by setting [GUIDEFAME] to [ON]. The frame is not recorded. Press DISP/BATT INFO to make the frame disappear.

Tips

- Positioning the subject at the cross point of the guide frame makes a balanced composition.

ZEBRA

Diagonal stripes appear in portions of the screen where brightness is at a preset level. This is useful as a guide when adjusting the brightness. When you change the default setting,  is displayed. The zebra pattern is not recorded.

▶ OFF

The zebra pattern is not displayed.

70

The zebra pattern appears at a screen brightness level of about 70 IRE.

100

The zebra pattern appears at a screen brightness level of about 100 IRE or higher.

Notes

- Portions of the screen where brightness is about 100 IRE or above may appear overexposed.



Tips

- IRE represents the screen brightness.

REMAINING

▶ AUTO

Displays the remaining disc indicator for about 8 seconds in situations such as those described below.

- When your camcorder recognizes the remaining disc capacity with the POWER switch set to  (Movie).
- When you press DISP/BATT INFO to switch the indicator from off to on with the POWER switch set to  (Movie).
- When you select the movie recording mode on the HOME MENU.

ON

Always displays the remaining disc indicator.

Notes

- When the remaining recordable time for movies is less than 5 minutes, the indicator stays on the screen.

SUB-T DATE

Select [ON] (the default setting) to display the recording date and time when you play back a disc on a device with a subtitle display function. Also refer to the instruction manual of the playback device.

Notes

- Discs recorded with HD (high definition) image quality can be played on AVCHD format compatible devices only (p. 70).

RING SETTING

You can assign an item you want to set to the camera control ring and adjust it manually using the camera control ring.

▶ FOCUS

Assigns [FOCUS] (p. 90) to the camera control ring.

EXPOSURE

Assigns [EXPOSURE] (p. 91) to the camera control ring.

PHOTO SETTINGS

(Items for recording still images)

AE SHIFT

Assigns [AE SHIFT] (p. 78) to the camera control ring.

WB SHIFT

Assigns [WB SHIFT] (p. 78) to the camera control ring.

Tips

- You can make this setting also by keeping MANUAL pressed.
- See page 42 on further details on the camera control ring.
- Manual settings will be retained even if you change the assigned item of the camera control ring. However, if you set [EXPOSURE] after setting [AE SHIFT] manually, [EXPOSURE] will override [AE SHIFT].

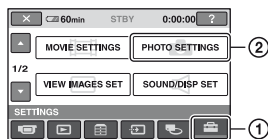

Touch ①, then ②.

If the item is not on the screen, touch ▲/▼ to change the page.

How to set

- ▲ (HOME MENU) → page 76
- ☰ (OPTION MENU) → page 88

The default settings are marked with ►.

IMAGE SIZE

► 4.0M (L4.0M)

Records still images clearly.

16:9 3.0M (L3.0M)

Records still images clearly in the 16:9 (wide) ratio.

1.9M (L1.9M)

Allows you to record more still images in relatively clear quality.

VGA (0.3M) (LVGA)

Allows the maximum number of still images to be recorded.





⚙ Notes

- [IMAGE SIZE] can be set only during recording standby.



PHOTO SETTINGS (Continued)



Capacity of the “Memory Stick Duo” (MB) and the number of recordable images

When the POWER switch is  (Still)



	4.0M 2304 × 1728 	3.0M 2304 × 1296 	1.9M 1600 × 1200 	VGA 640 × 480 
16MB	7 18	10 24	16 37	96 240
32MB	15 37	20 48	32 75	190 485
64MB	31 75	41 98	65 150	390 980
128MB	63 150	83 195	130 300	780 1970
256MB	110 270	150 355	235 540	1400 3550
512MB	230 550	305 720	480 1100	2850 7200
1GB	475 1100	620 1450	980 2250	5900 14500
2GB	970 2300	1250 3000	2000 4650	12000 30000

When the POWER switch is  (Movie)*

	2.3M 2016 × 1134 	1.7M 1512 × 1134 
16MB	13 32	17 40
32MB	27 65	36 85
64MB	54 130	72 170
128MB	105 260	145 340
256MB	195 470	260 590
512MB	400 960	530 1200

	2.3M 2016 × 1134 	1.7M 1512 × 1134 
1GB	820 1950	1050 2450
2GB	1650 4000	1800 4300

* The image size is fixed as follows depending on the recording image quality:

-  2.3M] with HD (high definition) image quality
-  2.3M] in the aspect ratio 16:9 with SD (standard definition) image quality
- [1.7M] in the aspect ratio 4:3 with SD (standard definition) image quality

Notes

- All numbers measured at the following setting:
Top: [FINE] is selected for image quality.
Bottom: [STANDARD] is selected for image quality.
- All numbers measured when using a “Memory Stick Duo” made by Sony Corporation. The number of recordable images varies depending on the recording environment.

Approximate data size of an image (kB)

4:3 image

4.0M	1.9M	1.7M	VGA
1980	960	860	150
830	420	370	60

16:9 image

3.0M	2.3M
1500	1150
640	480

- Data sizes measured at the following settings:
Top: [FINE] is selected for image quality.
Bottom: [STANDARD] is selected for image quality.

QUALITY



► FINE (FINE)

Records still images at the fine image quality level.

STANDARD (STD)

Records still images at the standard image quality level.

FILE NO.



► SERIES

Assigns file numbers in sequence even if the "Memory Stick Duo" is replaced with another one. The file number is reset when a new folder is created or the recording folder is replaced with another.

RESET

Resets the file number to 0001 each time the "Memory Stick Duo" is changed.

AE SHIFT



See page 78.

WB SHIFT (White Balance Shift)



See page 78.

NS LIGHT (NightShot Light)



See page 79.

EXP.FOCUS



See page 79.

GUIDEFAME



See page 80.

ZEBRA



See page 80.

FLASH LEVEL



You can set this function when you use the built-in flash, or an external flash (optional) that is compatible with your camcorder.

HIGH(↕+)

Makes the flash level higher.

► NORMAL(↕)

LOW(↕-)

Makes the flash level lower.

REDEYE REDUC



You can set this function when you use the built-in flash, or an external flash (optional) that is compatible with your camcorder.

You can prevent redeye by activating the flash before recording.

Set [REDEYE REDUC] to [ON], then press **↕** (flash) (p. 40) repeatedly to select a setting.

(Auto redeye reduction): Pre-flashes to reduce redeye before the flash automatically flashes when there is insufficient ambient light.



(Forced redeye reduction): Always uses the flash and the redeye reducing pre-flash.



(No flash): Records without flash.

- The redeye reduction may not produce the desired effect due to individual differences and other conditions.

RING SETTING



See page 80.

VIEW IMAGES SET

(Items to customize the sound volume and display)



Touch ①, then ②.

If the item is not on the screen, touch ▲/▼ to change the page.

How to set

🏠 (HOME MENU) → page 76

⊕ (OPTION MENU) → page 88

The default settings are marked with ▶.

VOLUME



Touch \ominus / \oplus to adjust the volume (p. 45).

DATA CODE



During playback, displays the information (data code) recorded automatically at the time of recording.

▶ OFF

Data code is not displayed.

DATE/TIME

Displays the date and time.

CAMERA DATA (below)

Displays camera setting data.

DATE/TIME

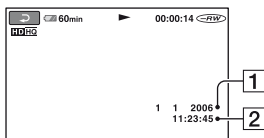

1 Date

2 Time

CAMERA DATA

Movie

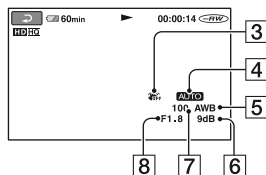

Still image

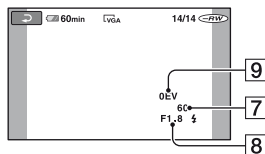

3 SteadyShot off

4 Brightness

5 White balance

6 Gain

7 Shutter speed

8 Aperture value

9 Exposure

💡 Tips

- ⚡ appears for an image recorded using a flash.
- The data code is displayed on the TV screen if you connect your camcorder to a TV.
- The indicator toggles through the following sequences as you press DATA CODE on the Remote Commander: [DATE/TIME] → [CAMERA DATA] → [OFF] (no indication).
- Depending on the disc condition, bars [---:---:---] appear.

SOUND/DISP SET

(Items to adjust beep and the screen)

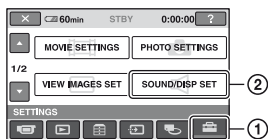

Touch ①, then ②.

If the item is not on the screen, touch ▲/▼ to change the page.

How to set

↑ (HOME MENU) → page 76

☰ (OPTION MENU) → page 88

The default settings are marked with ►.

BEEP

► ON

A melody sounds when you start/stop recording, or operate the touch panel.

OFF

Cancels the melody.

LCD BRIGHT

You can adjust the brightness of the LCD screen.

① Adjust the brightness with [-]/[+].

② Touch [OK].

💡 Tips

- This adjustment does not affect the recorded images in any way.

LCD BL LEVEL

You can adjust the brightness of the LCD screen's backlight.

► NORMAL

Standard brightness.

BRIGHT

Brightens the LCD screen.

📌 Notes

- When you connect your camcorder to outside power sources, [BRIGHT] is automatically selected for the setting.
- When you select [BRIGHT], battery life is slightly reduced during recording.
- If you open the LCD panel 180 degrees to face the screen outside and close the LCD panel to the camcorder body, the setting becomes [NORMAL] automatically.

💡 Tips

- This adjustment does not affect the recorded images in any way.

LCD COLOR

You can adjust the color of the LCD screen with [-]/[+].



Low intensity High intensity

💡 Tips

- This adjustment does not affect the recorded images in any way.

VF B. LIGHT

You can adjust the brightness of the viewfinder.

► NORMAL

Standard brightness.

BRIGHT

Brightens the viewfinder screen.

📌 Notes

- When you connect your camcorder to outside power sources, [BRIGHT] is automatically selected for the setting.
- When you select [BRIGHT], battery life is slightly reduced during recording.

💡 Tips

- This adjustment does not affect the recorded images in any way.

OUTPUT SETTINGS

(Items for when connecting other devices)

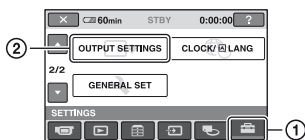

Touch ①, then ②.

If the item is not on the screen, touch ▲/▼ to change the page.

How to set

⬆️ (HOME MENU) → page 76

⊕ (OPTION MENU) → page 88

The default settings are marked with ▶.

TV TYPE

You need to convert the signal depending on the TV connected when playing back the image. The recorded images are played back as following illustrations.

▶ 16:9

Select to view your images on a 16:9 (wide) TV.

Wide (16:9) images



4:3 images



4:3

Select to view your images on a 4:3 standard TV.

Wide (16:9) images



4:3 images



🔔 Notes

- Aspect ratio of the image recorded with HD (high definition) image quality is 16:9.

DISP OUTPUT



▶ LCD PANEL

Shows displays such as the time code on the LCD screen and in the viewfinder.

V-OUT/PANEL

Shows displays such as the time code on the TV screen, LCD screen, and in the viewfinder.

COMPONENT



Select [COMPONENT] when connecting your camcorder to a TV with the component input jack.

576i

Select when connecting your camcorder to a TV with the component input jack.

▶ 1080i/576i

Select when connecting your camcorder to a TV that has the component input jack and is capable of displaying the 1080i signal.

CLOCK/LANG

(Items to set clock and language)

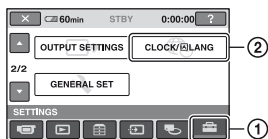

Touch ①, then ②.

If the item is not on the screen, touch ▲/▼ to change the page.

How to set

🏠 (HOME MENU) → page 76

☰ (OPTION MENU) → page 88

CLOCK SET

See page 31.

AREA SET

You can adjust a time difference without stopping the clock.

Set your local area using ▲/▼ when using your camcorder overseas.

Refer to the world time difference on page 124.

SUMMERTIME

You can change this setting without stopping the clock.

Set to [ON] to move the time forward 1 hour.

LANGUAGE SET

You can select the language to be used on the LCD screen.

Tips

- Your camcorder offers [ENG[SIMP]] (simplified English) for when you cannot find your native tongue among the options.

GENERAL SET

(Other setup items)

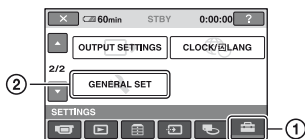

Touch ①, then ②.

If the item is not on the screen, touch ▲/▼ to change the page.

How to set



🏠 (HOME MENU) → page 76

☰ (OPTION MENU) → page 88

The default settings are marked with ▶.

DEMO MODE

The default setting is [ON], allowing you to view the demonstration in about 10 minutes, after you slide the POWER switch to  (Movie).

- The demonstration will be suspended in situations such as those described below.
 - When you touch the screen during the demonstration (The demonstration starts again after about 10 minutes).
 - When you slide the disc cover open switch.
 - When you remove or insert a “Memory Stick Duo.”
 - When you set the POWER switch to  (Still).
 - When you press  (HOME)/ (VIEW IMAGES).

REC LAMP (Recording lamp)

The camera recording lamp will not light up during recording when you set this to [OFF]. (The default setting is [ON].)

CALIBRATION

See page 132.

A. SHUT OFF (Auto shut off)



► 5 min

The camcorder is automatically turned off when you do not operate your camcorder for more than approximately 5 minutes.

NEVER

The camcorder is not automatically turned off.

- When you connect your camcorder to a wall socket, [A.SHUT OFF] is automatically set to [NEVER].

REMOTE CTRL (Remote control)



The default setting is [ON], allowing you to use the supplied Remote Commander (p. 142).

- Set to [OFF] to prevent your camcorder from responding to a command sent by another VCR remote control unit.

Activating functions using the OPTION MENU

The OPTION MENU appears just like the pop-up window that appears when you right-click the mouse on a computer. Various functions are displayed in the context of the operation.

Using the OPTION MENU

Notes

- The tabs and items that appear on the screen depend on the recording/playback status of your camcorder at the time.
- Some items appear without a tab.

- 1 While using your camcorder, touch  (OPTION) on the screen.

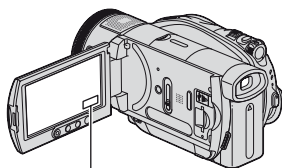

 (OPTION)

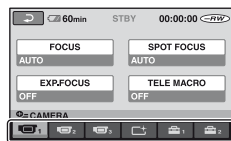

Tab

- 2 Touch the desired item.

If you cannot find the desired item, touch another tab to change the page.

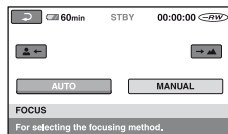







3 Change the setting, then touch .

When the item you want is not on the screen

Touch another tab. If you cannot find the item anywhere, the function does not work under the situation.

Recording items on the OPTION MENU

See page 88 for setting operation.

Items	 *	Page
 tab		
FOCUS	-	90
SPOT FOCUS	-	90
EXP.FOCUS	○	79
TELE MACRO	-	90
EXPOSURE	-	91
SPOT METER	-	91
AE SHIFT	○	78
PROGRAM AE	-	91
WHITE BAL.	-	92
WB SHIFT	○	78
COLOR SLOW S	-	92
SUPER NS	-	93
 tab		
FADER	-	93
D.EFFECT	-	93
PICT.EFFECT	-	94
 tab		
HD REC MODE	○	78
SD REC MODE	○	78
MICREF LEVEL	-	94
GUIDEFAME	○	80
ZEBRA	○	80
FLASH LEVEL	○	83
REDEYE REDUC	○	83
 IMAGE SIZE	○	81
 QUALITY	○	83
SELF-TIMER	-	94
TIMING	-	42

* Items that are included also in the HOME MENU.

Recording items on the OPTION MENU (Continued)

Items you can set only on the OPTION MENU will be described below.

How to set

(HOME MENU) → page 76

(OPTION MENU) → page 88

The default settings are marked with ►.

FOCUS

You can adjust the focus manually. You can select this function also when you want to focus on a certain subject intentionally.



- ① Touch [MANUAL].
 appears.
- ② Touch (focusing on close subjects)/
 (focusing on distant subjects) to sharpen the focus. appears when the focus cannot be adjusted any closer, and appears when the focus cannot be adjusted farther away.
- ③ Touch [OK].

To adjust the focus automatically, touch [AUTO] → [OK] in step ①.

- It is easier to focus on the subject by moving the power zoom lever towards T (telephoto) to adjust the focus, then towards W (wide angle) to adjust the zoom for recording. When you want to record a subject at close range, move the power zoom lever to W (wide angle), then adjust the focus.
- The minimum possible distance between camcorder and subject while maintaining sharp focus is about 1 cm (about 13/32 in.) for wide angle and about 80 cm (about 2 5/8 feet) for telephoto.
- The setting returns to [AUTO] when you set the POWER switch to OFF (CHG) for more than 12 hours.
- You can also adjust the focus manually using the camera control ring (p. 42).

SPOT FOCUS



You can select and adjust the focal point to aim it at a subject not located at the center of the screen.

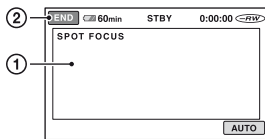

- ① Touch the subject on the screen.
 appears.
- ② Touch [END].

To adjust the focus automatically, touch [AUTO] → [END] in step ①.

- If you set [SPOT FOCUS], [FOCUS] is automatically set to [MANUAL].
- The setting returns to [AUTO] when you set the POWER switch to OFF (CHG) for more than 12 hours.

TELE MACRO



This is useful to shoot small subjects, such as flowers or insects. You can blur out backgrounds and the subject stands out clearer.

When you set [TELE MACRO] to [ON] (), the zoom (p. 39) moves to the top of the T (telephoto) side automatically and allows recording subjects at a close distance, down to about 37 cm (14 5/8 in.).



To cancel, touch [OFF], or zoom to wide-angle (W side).

- When recording a distant subject, focusing may be difficult and can take some time.
- Adjust the focus manually ([FOCUS], p. 90) when it is hard to focus automatically.

EXPOSURE



You can fix the brightness of an image manually. When recording indoors on a clear day, for instance, you can avoid backlight shadows on people next to the window by fixing the exposure to that of the wall side of the room.

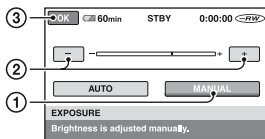

- ① Touch [MANUAL].

————— appears.

- ② Adjust the exposure by touching [—]/ [+] .
- ③ Touch [OK].

To return the setting to automatic exposure, touch [AUTO] → [OK] in step ①.

- The setting returns to [AUTO] when you set the POWER switch to OFF (CHG) for more than 12 hours.
- You can also adjust the setting manually using the camera control ring (p. 42).

SPOT METER (Flexible spot meter)



You can adjust and fix the exposure to the subject, so that it is recorded in suitable brightness even when there is strong contrast between the subject and the background, such as subjects in the spotlight on stage.

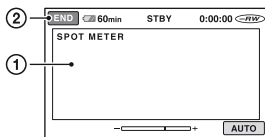

- ① Touch the point where you want to fix and adjust the exposure on the screen.

————— appears.

- ② Touch [END].

To return the setting to automatic exposure, touch [AUTO] → [END] in step ①.

- If you set [SPOT METER], [EXPOSURE] is automatically set to [MANUAL].
- The setting returns to [AUTO] when you set the POWER switch to OFF (CHG) for more than 12 hours.

PROGRAM AE



You can record images effectively in various situations with the [PROGRAM AE] function.

▶ AUTO

Select this to automatically record images effectively without the [PROGRAM AE] function.

SPOTLIGHT* (☹)

Select this to prevent people's faces from appearing excessively white when subjects are lit by strong light.



PORTRAIT (Soft portrait) (👤)



Select this to bring out the subject such as people or flowers while creating a soft background.

BEACH&SKI* (🏖)



Select this to prevent people's faces from appearing dark in strong light or reflected light, such as at a beach in midsummer or on a ski slope.

SUNSET&MOON** (🌅)



Recording items on the OPTION MENU (Continued)

Select this to maintain the atmosphere of situations such as sunsets, general night views or fireworks.

LANDSCAPE** (🌄)



Select this to shoot distant subjects clearly. This setting also prevents your camcorder from focusing on glass or metal mesh in windows that comes in between the camcorder and the subject.

- Items with one asterisk (*) are adjusted to focus on subjects only a short distance away. Items with two asterisks (**) are adjusted to focus on subjects farther away.
- The setting returns to [AUTO] when you set the POWER switch to OFF (CHG) for more than 12 hours.

WHITE BAL. (White balance)



You can adjust the color balance to the brightness of the recording environment.

▶ AUTO

The white balance is adjusted automatically.

OUTDOOR (☀️)

The white balance is adjusted to be appropriate for the following recording conditions:

- Outdoors
- Night views, neon signs and fireworks
- Sunrise or sunset
- Under daylight fluorescent lamps

INDOOR (🏠)

The white balance is adjusted to be appropriate for the following recording conditions:

- Indoors
- At party scenes or studios where the lighting conditions change quickly
- Under video lamps in a studio, or under sodium lamps or incandescent-like color lamps

ONE PUSH (📷)

The white balance will be adjusted according to the ambient light.

- ① Touch [ONE PUSH].
- ② Frame a white object such as a piece of paper, to fill the screen under the same lighting conditions as you will shoot the subject.
- ③ Touch [📷].

📷 flashes quickly. When the white balance has been adjusted and stored in the memory, the indicator stops flashing.

- Do not shake your camcorder while 📷 is flashing quickly.
- 📷 flashes slowly if white balance could not be set.
- If 📷 keeps flashing even after you have touched [OK], set [WHITE BAL.] to [AUTO].

- If you changed the battery pack, or moved your camcorder to or from outdoors when [AUTO] was selected, aim your camcorder at a nearby white object with [AUTO] for about 10 seconds for better color balance adjustment.
- Redo the [ONE PUSH] procedure if you change the [PROGRAM AE] settings, or bring your camcorder outdoors from inside the house, or vice versa.
- Set [WHITE BAL.] to [AUTO] or adjust the color in [ONE PUSH] under white or cool white fluorescent lamps.
- The setting returns to [AUTO] when you set the POWER switch to OFF (CHG) for more than 12 hours.

COLOR SLOW S (Color Slow Shutter)



When you set [COLOR SLOW S] to [ON], you can record an image brighter in color even in dark places.

📷 appears on the screen.

To cancel [COLOR SLOW S], touch [OFF].

- Adjust the focus manually ([FOCUS], p. 90) when it is hard to focus automatically.

- The shutter speed of your camcorder changes depending on the brightness, which may result in a slowdown of the motion of the image.

SUPER NS (Super NightShot)



The image will be recorded at a maximum of 16 times the sensitivity of NightShot recording if you set [SUPER NS] to [ON] while the NIGHTSHOT switch (p. 41) is also set to ON.

S  appears on the screen.

To return to the normal setting, set [SUPER NS] to [OFF].

- Do not use [SUPER NS] in bright places. This may cause a malfunction.
- Do not cover the infrared port with your fingers or other objects (p. 41).
- Remove the conversion lens (optional).
- Adjust the focus manually ([FOCUS], p. 90) when it is hard to focus automatically.
- The shutter speed of your camcorder changes depending on the brightness, which may result in a slowdown of the motion of the image.

FADER



You can record a transition with the following effects adding to the interval between scenes.

- ① Select the desired effect in [STBY] (during fading in) or [REC] (during fading out) mode, then touch **[OK]**.
- ② Press START/STOP.
The fader indicator stops flashing and disappears when the fade is complete.

To cancel the fader before starting the operation, touch [OFF] in step ①.

If you press START/STOP, the setting is canceled.



WHITE FADER



BLACK FADER



D. EFFECT (Digital effect)



You can add digital effects to your recordings. **D+** appears.

- ① Touch the desired effect.
- ② When you select [LUMI. KEY], adjust the effect with **[-]** / **[+]**, then touch **[OK]**.
The image displayed when you touch **[OK]** is saved as a still image.
- ③ Touch **[OK]**.
D+ appears.

To cancel [D. EFFECT], touch [OFF] in step ①.

LUMI. KEY (luminance key)

Replaces a brighter area in a previously recorded still image (e.g. a person) with a movie.



OLD MOVIE

Adds an old movie effect to images. The scene is recorded in the 16:9 (wide) mode.

- The aspect ratio cannot be changed when [OLD MOVIE] is selected.

Recording items on the OPTION MENU (Continued)

PICT. EFFECT (Picture effect)



You can add special effects to an image during recording or playback.  appears.

► OFF

Does not use [PICT. EFFECT] setting.

SEPIA

Images appear in sepia.

B&W

Images appear in black and white.

PASTEL *



Images appear as a pale pastel drawing.

MICREF LEVEL



You can select the microphone level for recording sound.

Select [LOW] when you want to record exciting and powerful sound in a concert hall, etc.

► NORMAL

Records various surround sounds, converting them into the certain level.

LOW (⇅)

Records surround sound faithfully. This setting is not suitable for recording conversations.

- The setting returns to [NORMAL] when you set the POWER switch to OFF (CHG) for more than 12 hours.

SELF-TIMER



The self-timer starts recording a still image after about 10 seconds.







Press PHOTO to record still images when [SELF-TIMER] is set to [ON] and  appears.

To cancel the count down, touch [RESET].
To cancel the self-timer, select [OFF].

- You can also operate by pressing PHOTO on the Remote Commander (p. 142).

Viewing items on the OPTION MENU

See page 88 for setting operation.

Items	 *	Page
 tab		
DELETE	<input type="radio"/>	54
DELETE ALL	<input type="radio"/>	55
<hr/>		
 tab		
DIVIDE	<input type="radio"/>	56
ERASE	<input type="radio"/>	58
ERASE ALL	<input type="radio"/>	59
MOVE	<input type="radio"/>	59
<hr/>		
-- (A tab depends on the situation)		
 ADD	<input type="radio"/>	58
 ADD ALL	<input type="radio"/>	58
PRINT	<input type="radio"/>	63
SLIDE SHOW	-	47
VOLUME	<input type="radio"/>	84
DATA CODE	<input type="radio"/>	84
SLIDE SHOW SET	-	47
 ADD	<input type="radio"/>	57
 ADD ALL	<input type="radio"/>	58
<hr/>		
-- (No tab)		
COPIES	-	64
DATE/TIME	-	64
SIZE	-	64
DISC MENU (DVD MENU for SD (standard definition) image quality)	<input type="radio"/>	69

* Items that are included in the HOME MENU also.

What you can do with Windows computer

When you install the “Picture Motion Browser” on a Windows computer from the supplied CD-ROM, you can enjoy the following operations.

💡 Tips

- See page 101 when you use a Macintosh computer.

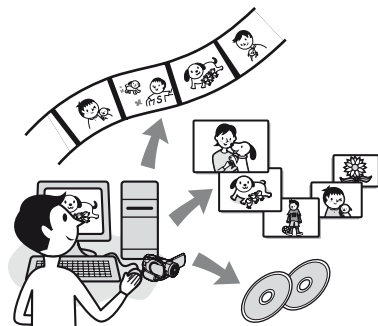

Main functions

■ Playing a disc in AVCHD format → Player for AVCHD

You can view movies recorded on a disc in AVCHD format using your camcorder by inserting the disc into the DVD drive of your computer.

🔊 Notes

- Even in a computer environment where the operations are guaranteed, some frames may be dropped from movies.

■ Importing movies taken with your camcorder

You can import the movies recorded with HD (high definition) image quality as they are.

■ Viewing movies imported to a computer

You can manage movies and still images by date and time of shooting, and select movies or still images you want to view as

thumbnails. These thumbnails can be enlarged and played in a slide show.

■ Creating a disc in AVCHD format

Selected from the movies imported, you can create a disc consisting of movies with HD (high definition) image quality.

■ Copying a disc → Video Disc Copier

You can copy all the images on a disc taken with your camcorder.

About “First Step Guide”

The “First Step Guide” is an instruction manual you can refer to on your computer. This describes basic operations, from initial hookup of your camcorder and computer and making settings, to general operation the first time you use the software “Picture Motion Browser” stored on the CD-ROM (supplied).

Referring to “Installing the “First Step Guide”” (p. 98), start the “First Step Guide”, then follow the instructions.

About the help function of the software

The Help guide explains all the functions of all the software applications. Refer to the Help guide for further detailed operations after reading the “First Step Guide” thoroughly.

To display the Help guide, click the [?] mark on the screen.

System requirements

When using “Picture Motion Browser”

OS: Microsoft Windows 2000 Professional, Windows XP Home Edition or Windows XP Professional
Standard installation is required.
Operation is not assured if the above OS

has been upgraded or in a multi-boot environment.

CPU: Intel Pentium 4 2.8 GHz CPU or faster (Pentium 4 3.6 GHz or faster is recommended.)

For processing SD (standard definition) image quality content only, an Intel Pentium III 1 GHz or faster is necessary.

Application: DirectX 9.0c or later (This product is based on DirectX technology. It is necessary to have DirectX installed.)
.Net Framework 1.1 (installed with Picture Motion Browser, depending on your computer environment)

Sound system: Direct Sound compatible sound card

Memory: 512 MB or more (1 GB or more is recommended.)

For processing SD (standard definition) image quality content only, 256 MB of memory or more is necessary.

Hard disk:

Disc volume required for installation:
Approximately 800 MB (10 GB or more may be necessary when creating AVCHD format discs.)

Display: DirectX 7 or later-compatible video card, Minimum 1024 X 768 dots, High Color (16 bit color)

Others: USB port (this must be provided as standard, Hi-Speed USB (USB 2.0 compatible) is recommended), optical disc drive (CD-ROM drive is necessary for installation)

When playing still images recorded on a “Memory Stick Duo” on a computer

OS: Microsoft Windows 2000 Professional, Windows XP Home Edition or Windows XP Professional
Standard installation is required.
Operation is not assured if the above OS has been upgraded.

CPU: MMX Pentium 200 MHz or faster

Others: USB port (this must be provided as standard)

Note

- Operations are not guaranteed on all the recommended environments.
For example, other open or background applications running on currently may limit product performance.
- Even in a computer environment where the operations are guaranteed, frames may be dropped from movies with HD (high definition) image quality, resulting in uneven playback. However, imported images and images on discs created subsequently will not be affected.

Tips

- If your computer has a Memory Stick slot, insert the “Memory Stick Duo” on which still images are recorded into the Memory Stick Duo Adaptor (optional), then insert it into the Memory Stick slot on your computer to copy still images to the computer.
- When using a “Memory Stick PRO Duo” and your computer is not compatible with it, connect your camcorder with the USB cable instead of using the Memory Stick slot on the computer.

Installing the “First Step Guide” and software

You need to install the “First Step Guide” and software to your Windows computer **before connecting your camcorder to the computer**. The installation is required only for the first time. Contents to be installed and procedures may differ depending on your OS.

Tips

- See page 101 when you use a Macintosh computer.

Installing the “First Step Guide”

1 Confirm that your camcorder is not connected to the computer.

2 Turn on the computer.

- Log on as Administrators for installation.
- Close all applications running on the computer before installing the software.

3 Place the supplied CD-ROM in the disc drive of your computer.

The installation screen appears.



If the screen does not appear

- ① Click [Start], then click [My Computer]. (For Windows 2000, double-click [My Computer].)
- ② Double-click [SONYPICTUTIL (E:)] (CD-ROM) (disc drive).*

* Drive names (such as (E:)) may vary depending on the computer.

4 Click [FirstStepGuide].



5 Select your language from the pull-down menu.

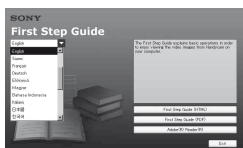

6 Click [FirstStepGuide(HTML)].

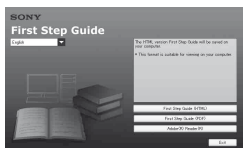

Installation starts.

When [Save is complete] appears, click [OK] to finish the installation.

To install the First Step Guide in PDF

In step 4, click [FirstStepGuide(PDF)].

To install the software “Adobe Reader” to display the PDF file

In step 4, click [Adobe(R) Reader(R)].

Installing the software

- 1 Perform steps 1 to 3 in “Installing the “First Step Guide”” (p. 98).



- 2 Click [Install].



- 3 Select the language for the application to be installed, then click [Next].

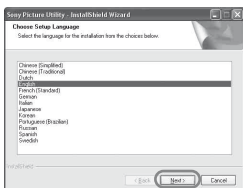

- 4 Click [Next].

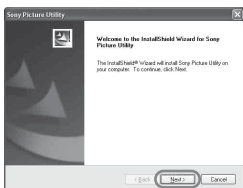

- 5 Read [License Agreement], select [I accept the terms of the license agreement] when you agree, then click [Next].

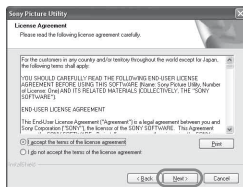

- 6 Select your camcorder video system, then click [Next].

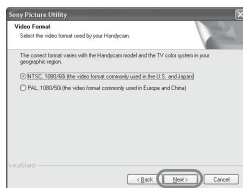

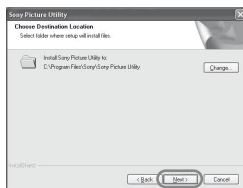

- 7 Select where to save the software, then click [Next].

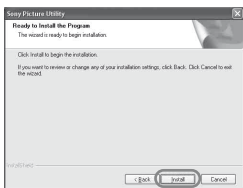

- 8 Click [Install] on the [Ready to Install the Program].

The installation of Picture Motion Browser starts.



The short-cut icons, such as  (Picture Motion Browser), appear on the desktop.



9 One of the following installation screens appears, depending on the computer environment. Check the screen and follow the instructions displayed to install the required software.

■ **Sonic UDF Reader**

Software required to recognize an AVCHD format disc

■ **Windows Media Format 9 Series Runtime (Windows 2000 only)**

Software required to create a DVD

■ **Microsoft .NET Framework 1.1**

Software required to create AVCHD

■ **Microsoft DirectX 9.0c**

Software required to handle movies

11 Remove the CD-ROM from the disc drive of your computer.

10 Make sure [Yes, I want to restart my computer now.] is selected, then click [Finish].

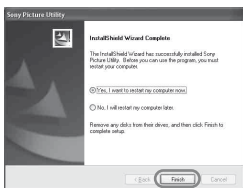

The computer restarts automatically (Restart).

Viewing “First Step Guide”

💡 Tips

- See page 101 when you use a Macintosh computer.

To view “First Step Guide” on your computer, Microsoft Internet Explorer Ver.6.0 or later is recommended. Double-click the [HDR-UX1 First Step Guide (HTML)] icon on the desktop.



- You can also start by selecting [Start], [Programs] ([All Programs] for Windows XP), [Sony Picture Utility], [First Step Guide], [HDR-UX1], then [HDR-UX1 First Step Guide.html].
- To view “First Step Guide” in HTML without installing, copy the desired language folder from the [FirstStepGuide] folder on the CD-ROM, and then double-click [Index.html].
- Refer to “FirstStepGuide(PDF)” in the following cases:
 - When printing the desired topics of “First Step Guide”
 - When “First Step Guide” is not displayed correctly due to the browser setting even in recommended environment.
 - When the HTML version of “First Step Guide” cannot be installed.

Using a Macintosh computer

You can copy the still images from the “Memory Stick Duo” to the Macintosh. Install “First Step Guide” in the supplied CD-ROM.

🔗 Notes

- The supplied software “Picture Motion Browser” does not operate on Mac OS.
- Refer to “First Step Guide” for the details on connecting your camcorder to the computer and copying the still images.

System requirements

To copy still images from a “Memory Stick Duo”

OS: Mac OS 9.1/9.2 or Mac OS X (v10.1/v10.2/v10.3/v10.4).

Others: 🗑️ USB port (this must be provided as standard)

About “First Step Guide”

The “First Step Guide” is an instruction manual you can refer to on your computer. This describes basic operations, from initial hookup of your camcorder and computer and making setting. Referring to “Installing the “First Step Guide””, start the “First Step Guide”, then follow the instructions.

Installing “First Step Guide”

Copy “FirstStepGuide(PDF),” stored in the desired language in the [FirstStepGuide] folder, to your computer.

Viewing “First Step Guide”

Double-click “FirstStepGuide(PDF)”.

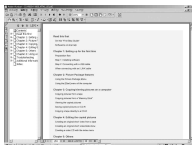

To view the PDF, Adobe Reader is needed. If it is not installed on your computer, you can download it from the Adobe Systems web page:
<http://www.adobe.com/>

Troubleshooting

If you run into any problems using your camcorder, use the following table to troubleshoot the problem. If the problem persists, disconnect the power source and contact your Sony dealer.

Overall operations

The camcorder does not operate even when the power is set to on.

- It takes a few seconds for your camcorder to be ready to shoot after the power is turned on. This is not a malfunction.
- Disconnect the AC Adaptor from the wall socket or remove the battery pack, then reconnect it after about 1 minute. If the functions still do not work, press the RESET button (p. 140) using a sharp-pointed object. (If you press the RESET button, all settings, including the clock setting, are reset.)
- The temperature of your camcorder is extremely high. Turn off your camcorder and leave it for a while in a cool place.

[DEMO MODE] does not start.

- Set the POWER switch to  (Movie).

Your camcorder vibrates.

- Vibration occurs depending on the condition of the disc. This is not a malfunction.

A vibration is felt in your hand or a faint sound is heard during operation.

- This is not a malfunction.

A motor sound is heard from your camcorder periodically.

- This is not a malfunction.

A motor sound is heard in the camcorder when the disc cover is closed without a disc.

- Your camcorder is trying to recognize the disc. This is not a malfunction.

Your camcorder gets warm.

- This is because the power has been turned on for a long time. This is not a malfunction. Turn off your camcorder and leave it for a while in a cool place.

Batteries/Power sources

The power does not turn on.

- The battery pack is not attached to the camcorder. Attach a charged battery pack to the camcorder (p. 26).
- The battery pack is discharged or running low. Charge the battery pack (p. 26).
- The plug of the AC Adaptor has been disconnected from the wall socket. Connect it to the wall socket (p. 26).

The power abruptly turns off.

- When approximately 5 minutes have elapsed while you do not operate your camcorder, the camcorder is automatically turned off (A.SHUT OFF). Change the setting of [A.SHUT OFF] (p. 88), or turn on the power again, or use the AC Adaptor.
 - The battery pack is discharged or running low. Charge the battery pack (p. 26).
-

The power turns off soon.

- If you attach the battery or AC Adaptor to the camcorder with the POWER switch set to OFF (CHG), the camcorder turns on once, then off again, after a few seconds. This is not a malfunction.
-

The CHG (charge) lamp does not light while the battery pack is being charged.

- Slide the POWER switch to OFF (CHG) (p. 26).
 - Attach the battery pack to the camcorder correctly (p. 26).
 - Connect the mains lead to the wall socket properly.
 - The battery charge is completed (p. 26).
-

The CHG (charge) lamp flashes while the battery pack is being charged.

- Attach the battery pack to the camcorder correctly (p. 26). If the problem persists, disconnect the AC Adaptor from the wall socket and contact your Sony dealer. The battery pack may be damaged.
-

The power turns off frequently although the remaining battery indicator indicates that the battery pack has enough power to operate.

- A problem has occurred in the remaining battery time indicator, or the battery pack has not been charged enough. Fully charge the battery again to correct the indication (p. 26).
-

The remaining battery time indicator does not indicate the correct time.

- The temperature of the environment is too high or too low. This is not a malfunction.
 - The battery pack has not been charged enough. Fully charge the battery again. If the problem persists, replace the battery pack with a new one (p. 26).
 - The indicated time may not be correct depending on the environment of use. When you open or close the LCD screen, it takes about 1 minute to display the correct remaining battery time.
-

The battery pack is quickly discharged.

- The temperature of the environment is too high or low. This is not a malfunction.
 - The battery pack has not been charged enough. Fully charge the battery again. If the problem persists, replace the battery pack with a new one (p. 26).
-

A problem occurs when the camcorder is connected to the AC Adaptor.

- Turn off the power, and disconnect the AC Adaptor from the wall socket. Then, connect it again.

LCD screen/viewfinder

An unknown image appears on the LCD screen or viewfinder.

- The camcorder is in [DEMO MODE] (p. 87). Touch the LCD screen to cancel [DEMO MODE].

An unknown indicator appears on the screen.

- A warning indicator or message appears on the screen (p. 118).

The image remains on the LCD screen.

- This occurs if you disconnect the DC plug or remove the battery pack without turning off the power first. This is not a malfunction.

The buttons do not appear on the touch panel.

- Touch the LCD screen lightly.
- Press DISP/BATT INFO on your camcorder (or DISPLAY on the Remote Commander) (p. 30).

The buttons on the touch panel do not work correctly or do not work at all.

- Adjust the touch panel ([CALIBRATION]) (p. 132).

The image in the viewfinder is not clear.

- Move the viewfinder lens adjustment lever until the image appears clearly (p. 31).

The image in the viewfinder has disappeared.

- Close the LCD panel. No image is displayed in the viewfinder when the LCD panel is open (p. 31).

Discs

The disc cannot be removed.

- Make sure the power source (battery pack or AC Adaptor) is connected correctly (p. 26).
- Remove the battery pack from the camcorder, then attach it again (p. 27).
- Attach a charged battery pack to the camcorder (p. 26).
- The disc is damaged or is dirty with fingerprints, etc. In this case, it may take up to 10 minutes to remove the disc.
- The temperature of your camcorder is extremely high. Turn off your camcorder and leave it for a while in a cool place.
- Moisture condensation has occurred with the disc. Turn off your camcorder and leave it for about 1 hour in a cool place (p. 132).
- Finalizing is interrupted by turning off your camcorder. Turn on your camcorder and remove the disc after finalizing is completed (p. 68).

Images cannot be deleted.

- The maximum number of images that you can delete on the index screen at one time is 100.
 - Images cannot be deleted depending on the type and mode of a disc (p. 16).
-

Remaining disc space indicator is not displayed.

- Set [ REMAINING] to [ON] to always display the remaining disc space indicator (p. 80).
-

The indicators of the disc type and the recording format on the LCD screen are grayed out.

- The disc may have been created other than your camcorder. You can play back with your camcorder, but you cannot record additional scenes.
-

“Memory Stick Duo”

You cannot operate functions using the “Memory Stick Duo.”

- Insert a “Memory Stick Duo” into your camcorder (p. 35).
 - If you use a “Memory Stick Duo” formatted on a computer, format it again on your camcorder (p. 73).
-

Images cannot be deleted.

- Release the lock on the write-protect tab of the “Memory Stick Duo” if there is one (p. 128).
 - The maximum number of images that you can delete on the index screen at one time is 100.
 - You cannot delete the images protected on another device. Release the protection of the images on the device which you protected the images.
-

You cannot delete all images at once.

- Release the lock on the write-protect tab of the “Memory Stick Duo” if there is one (p. 128).
-

You cannot format the “Memory Stick Duo.”

- Release the lock on the write-protect tab of the “Memory Stick Duo” if there is one (p. 128).
-

The data file name is not indicated correctly.

- Only the file name is displayed, unless the directory structure conforms to the universal standard.
 - The file is damaged.
 - The file format is not supported by your camcorder (p. 128).
-

The data file name flashes.

- The file is damaged.
 - The file format is not supported by your camcorder (p. 128).
-

Recording

Refer also to “Adjusting the image during recording” (p. 109).

Pressing START/STOP does not record movies on the disc.

- The playback screen is displayed. Set your camcorder to recording standby (p. 38).
- Your camcorder is recording the scene you have just shot on the disc.
- The disc has run out of space. Use a new disc or format the disc (DVD-RW/DVD+RW only, p. 72). Or delete the unnecessary images (p. 54).
- When you are using one of the following discs after finalizing it, make the disc to be able to record additional scenes (p.74). Or use a new disc.
 - DVD+RW
 - DVD-RW recorded with HD (high definition) image quality
 - DVD-RW (VR mode) recorded with SD (standard definition) image quality
- The temperature of your camcorder is extremely high. Turn off your camcorder and leave it for a while in a cool place.
- Moisture condensation has occurred with the disc. Turn off your camcorder and leave it for about 1 hour in a cool place (p. 132).

You cannot record a still image.

- The playback screen is displayed. Set your camcorder to recording standby (p. 38).
- Release the lock on the write-protect tab of the “Memory Stick Duo” if there is one (p. 128).
- The “Memory Stick Duo” has run out of space. Use a new “Memory Stick Duo” or format the “Memory Stick Duo” (p. 73). Or delete the unnecessary images (p. 55).
- You cannot record a still image together with:
 - [SMTH SLW REC]
 - [FADER]
 - [D.EFFECT]
 - [PICT.EFFECT]
- You cannot record a still image on a disc on your camcorder.

The ACCESS lamp lights up even when you stop recording.

- Your camcorder is recording the scene you have just shot on the disc.

The recording angle differs depending on the POWER switch setting position.

- The recording angle for the still image is wider than the one for the movie.

The shutter sound is not heard when you record a still image.

- Set [BEEP] to [ON] (p. 85).
- The shutter does not sound when using the Dual Rec function.

The flash does not work.

- You cannot record with the flash with:

Troubleshooting (Continued)

- Capturing still images while shooting a movie
- [SMTH SLW REC]
- [FADER]
- [PICT.EFFECT]
- [D.EFFECT]
- The conversion lens (optional) attached
- Even if auto flash or  (Auto re-eye reduction) is selected, you cannot use the internal flash with:
 - NightShot
 - [SUPER NS]
 - [SPOTLIGHT], [SUNSET&MOON] or [LANDSCAPE] in [PROGRAM AE]
 - [MANUAL] in [EXPOSURE]
 - [SPOT METER]

The external flash (optional) does not work.

- The power of the flash is not turned on, or the flash is not attached correctly.

You cannot record still images continuously.

- You cannot record still images continuously with your camcorder.

The actual recording time for movie is less than the expected approximate recording time of a disc.

- Depending on an object, such as a fast moving object, the time available for recording may shorten (p. 15, 78).

The recording stops.

- The temperature of your camcorder is extremely high. Turn off your camcorder and leave it for a while in a cool place.
- Moisture condensation has occurred with the disc. Turn off your camcorder and leave it about 1 hour in a cool place (p. 132).

There is a time difference between the point where you press START/STOP and the point that the recorded movie starts/stops.

- On your camcorder, there may be a slight time difference between the point where you press START/STOP and the actual point that recording movie starts/stops. This is not a malfunction.

The movie aspect ratio (16:9/4:3) cannot be changed.

- The aspect ratio of the movie recorded with HD (high definition) image quality is 16:9.
- The aspect ratio cannot be changed in DVD+RW recorded with SD (standard definition) image quality. Format the disc again to change the aspect ratio.

Adjusting the image during recording

Refer also to “Menu” (p. 112).

The auto focus does not function.

- Set [FOCUS] to [AUTO] (p. 90).
- The recording conditions are not suitable for auto focus. Adjust the focus manually (p. 90).

[STEADYSHOT] does not function.

- Set [STEADYSHOT] to [ON] (p. 79).
- [STEADYSHOT] may not be able to compensate for excessive vibrations.

The BACK LIGHT function does not function.

- In the following settings, the BACK LIGHT function is canceled:
 - [MANUAL] in [EXPOSURE] (p. 91)
 - [SPOT METER] (p. 91)

The subjects passing by the frame very fast appear crooked.

- This is called the focal plane phenomenon. This is not a malfunction. Because of the way the image device (CMOS sensor) reads out image signals, the subjects passing by the frame rapidly might appear crooked depending on the recording conditions.

Tiny spots in white, red, blue, or green appear on the screen.

- The spots appear when you are recording with [SUPER NS] or [COLOR SLOW S]. This is not a malfunction.

The color of the image is not correctly displayed.

- Set the NIGHTSHOT switch to OFF (p. 41).

The screen image is bright, and the subject does not appear on the screen.

- Set the NIGHTSHOT switch to OFF (p. 41).

The screen image is dark, and the subject does not appear on the screen.

- Press and hold DISP/BATT INFO for a few seconds to turn on the backlight (p. 30).

The image appears too bright or flickering, or changes in color.

- This occurs when recording images under a fluorescent lamp, sodium lamp, or mercury lamp. Cancel [PROGRAM AE] to minimize this phenomena (p. 91).

Black bands appear when you record a TV screen or computer screen.

- Set [STEADYSHOT] to [OFF] (p. 79).

Remote Commander

The supplied Remote Commander does not function.



- Set [REMOTE CTRL] to [ON] (p. 88).
- Insert a battery into the battery holder with the +/- polarities correctly matching the +/- marks (p. 134).
- Remove any obstructions between the Remote Commander and the remote sensor.
- Point the remote sensor away from strong light sources such as direct sunlight or overhead lighting. Otherwise, the Remote Commander may not function properly.
- Remove the conversion lens (optional) as the remote sensor may be obstructed by it.

Another DVD device malfunctions when you use the supplied Remote Commander.

- Select a commander mode other than DVD 2 for your DVD device, or cover the sensor of your DVD device with black paper.

Playing back a disc on your camcorder

You cannot play back a disc.

- Slide the POWER switch to turn on your camcorder and press  (VIEW IMAGES).
- On the HOME MENU, touch  (VIEW IMAGES), then [VISUAL INDEX].
- Check out the disc compatibility (p. 16).
- Insert a disc with the recording side facing your camcorder (p.33).
- The disc that was recorded, formatted, or finalized on other devices may not be played back on your camcorder.

The playback image is distorted.

- Clean the disc using a soft cloth (p. 126).

Still images stored on a “Memory Stick Duo” are not played back in the actual size.

- Still images recorded on other devices may not appear in the actual size. This is not a malfunction.

Still images stored on a “Memory Stick Duo” cannot be played back.

- Still images cannot be played back if you have modified files or folders, or have edited the data on a computer. (The file name flashes in that case.) This is not a malfunction (p. 129).
- Still images recorded on other devices may not be played back. This is not a malfunction (p. 129).

“?” is indicated on an image in the VISUAL INDEX screen.

- Loading of the data may have failed. It may be indicated correctly when you turn off the power and then turn it on again, or repeat removing and inserting the “Memory Stick Duo” a couple of times.
- This may appear on still images recorded on other devices, edited on a computer, etc.

No sound or only a quiet sound is heard when playing back a disc.

- Turn up the volume (p. 45).
- Sound is not output when the LCD screen is closed. Open the LCD screen.
- When you record sound with [MICREF LEVEL] (p. 94) set to [LOW], the recorded sound may be difficult to hear.
- You cannot record sounds during [SMTH SLW REC].

Viewing on the TV

You cannot view the image or hear the sound on the TV connected with the component video cable.

- Set [COMPONENT] according to the requirements of the connected device (p. 86).
- When you are using the component video cable, make sure the red and white plugs of the A/V connecting cable are connected (p. 49).

You cannot view the image or hear the sound on the TV connected with the HDMI cable.

- Images are not output from the HDMI OUT jack, if copyright protection signals are recorded in the images.

You cannot hear the sound.

- When you are using the component video cable, make sure the red and white plugs of the A/V connecting cable are connected (p. 49, 52).
- When you are using the S VIDEO plug, make sure the red and white plugs of the A/V connecting cable are connected (p. 52).

The aspect ratio of the playback is not correct when connecting your camcorder to the TV.

- Set [TV TYPE] depending on your TV (p. 86).

The image appears distorted on the 4:3 TV.

- This happens when viewing a image recorded in the 16:9 (wide) mode on a 4:3 TV. Set [TV TYPE] correctly (p. 86) and play back the image.

Playing back a disc on other devices

You cannot play back the disc, or the disc is not recognized.

- To play back a disc recorded with HD (high definition) image quality, you need a device compatible with AVCHD format (p. 70).
- Clean the disc using a soft cloth (p. 126).
- Finalize the disc (p. 66).
- A disc recorded in VR mode cannot be played back on a device that does not support VR mode. Check the compatibility in the instruction manual of the playback device.

The playback image is distorted.

- Clean the disc using a soft cloth (p. 126).

“?” is indicated on an image in the disc menu/DVD menu.

- Loading of the data may have failed when the disc was finalized. For the following discs, make the disc capable of additional recording (p. 74), then remake the disc menu by finalizing the disc again (p. 68). The disc menu/DVD menu may be displayed correctly.
 - DVD+RW
 - DVD-RW recorded with HD (high definition) image quality
 - DVD-RW (VIDEO mode) recorded with SD (standard definition) image quality

Playback freezes for an instant between the scenes.

- The image may freeze for an instant between scenes depending on the device being used. This is not a malfunction.
- In case of a DVD+R DL, the image may freeze for an instant when the recording layer changes. This is not a malfunction.

Playback does not move to the previous scene when you press **⏮**.

- If playback crosses 2 titles made automatically by your camcorder when **⏮** is pressed, playback may not move to the previous scene. Select the desired scene from the menu screen. Refer to the instruction manual of the playback device for further information.

Menu

Menu items are grayed out.

- You cannot select grayed items in the current recording/playback situation.
- There are some functions you cannot activate simultaneously. The following list shows examples of unworkable combinations of functions and menu items.

Cannot use	Because of following settings
[PROGRAM AE]	NightShot, [SUPER NS], [COLOR SLOW S], [OLD MOVIE], [TELE MACRO]
[SPOT METER]	NightShot, [SUPER NS]

Cannot use	Because of following settings
[EXPOSURE]	NightShot, [SUPER NS]
[WHITE BAL.]	NightShot, [SUPER NS]
[ONE PUSH] in [WHITE BAL.]	[SMTH SLW REC]
[SPOT FOCUS]	[PROGRAM AE]
[SUPER NS]	[FADER], [D.EFFECT]
[COLOR SLOW S]	[FADER], [D.EFFECT], [PROGRAM AE]
[FADER]	[SUPER NS], [COLOR SLOW S], [D.EFFECT]
[D.EFFECT]	[SUPER NS], [COLOR SLOW S], [FADER]
[OLD MOVIE]	[PROGRAM AE], [PICT.EFFECT]
[PICT.EFFECT]	[OLD MOVIE]
[STEADYSHOT]	[SMTH SLW REC]
[EXP.FOCUS]	[SMTH SLW REC], [DIGITAL ZOOM]
[TELE MACRO]	[PROGRAM AE]

[SUPER NS] cannot be operated.

- Set the NIGHTSHOT switch to ON.

[COLOR SLOW S] does not operate correctly.

- [COLOR SLOW S] may not operate correctly in total darkness. Use NightShot or [SUPER NS].

You cannot adjust [LCD BL LEVEL].

- You cannot adjust [LCD BL LEVEL] when:
 - The LCD panel is closed on your camcorder with the LCD screen facing out.
 - The power is supplied from the AC Adaptor.

You cannot use [WIDE SELECT].

- You cannot use [WIDE SELECT] together with:
 - HD (high definition) image quality
 - SD (standard definition) image quality on DVD+RW
- There is no disc in your camcorder.

Editing movies on the disc

The discs you can edit on your camcorder are:

- DVD-RW/DVD+RW recorded with HD (high definition) image quality
 - DVD-RW (VR mode) recorded with SD (standard definition) image quality
-

Unable to edit.

- There are no images recorded on the disc.
 - Unable to edit because of the condition of the image.
 - You cannot edit an image protected on another device.
 - You cannot copy or move the images between a disc and a “Memory Stick Duo.”
-

Scenes cannot be added in the Playlist.

- The disc is full, or the added scenes exceed 999. Delete unnecessary scenes (p. 54).
 - You cannot add still images in the Playlist.
-

A movie cannot be divided.

- A movie that is too short cannot be divided.
 - A movie protected on another device cannot be divided.
-

A scene cannot be deleted.

- A scene protected on another device cannot be deleted.
-

Dubbing/Editing/Connecting to other devices

Refer also to “Viewing on the TV” (p. 111).

No sound is heard when playing back a disc.

- The audio will not be output when you connect a device via the S VIDEO plug only. Connect the white and red plugs of the A/V connecting cable, too (p. 52).
-

You cannot dub correctly using the HDMI cable.

- You cannot dub images using the HDMI cable.
-

You cannot dub correctly using the A/V connecting cable.

- The A/V connecting cable is not connected properly. Make sure that the A/V connecting cable is connected to the proper jack, i.e. to the input jack of another device for dubbing a image from your camcorder (p. 62).
-

Prints cannot be made using a PictBridge printer.

- Your printer may not print images edited on a computer or recorded using other devices. This is not a malfunction.

Others

You cannot delete an image.

- You cannot delete images from a DVD-R/DVD+R DL.
- You cannot delete images recorded with SD (standard definition) image quality on a DVD-RW (VIDEO mode)/DVD+RW.
- You cannot delete images from a “Memory Stick Duo” that has been protected with another device.

Unable to copy the images from a disc to a “Memory Stick Duo.”

- You cannot copy a movie from a disc to a “Memory Stick Duo” as a still image during playback on your camcorder.

Unable to finalize.

- Battery is running out during finalizing. Use the AC Adaptor.
- The disc has already been finalized. In the case of following discs, unfinalize them to record additional material (p. 74):
 - DVD+RW
 - DVD-RW recorded with HD (high definition) image quality
 - DVD-RW (VIDEO mode) recorded with SD (standard definition) image quality

You cannot edit or record additional material on a disc using other devices.

- You may not be able to edit a disc recorded on your camcorder using other devices.

A disc title cannot be set.

- You cannot set a disc title on your camcorder.

The beep sounds for 5 seconds.

- The temperature of your camcorder is extremely high. Turn off your camcorder and leave it for a while in a cool place.
- Moisture condensation has occurred with the disc. Turn off your camcorder and leave it for about 1 hour, then turn on your camcorder again (p. 132).
- Some problems have occurred in your camcorder. Remove the disc and insert it again, then operate your camcorder again.

Unable to unfinalize.

- You cannot unfinalize:
 - DVD-R
 - DVD+R DL
 - DVD+RW recorded with SD (standard definition) image quality
 - DVD-RW (VR mode) recorded with SD (standard definition) image quality

Connecting to a computer

When using the movies on a disc, a computer does not recognize your camcorder.

- Install Picture Motion Browser (p. 98).
- Disconnect the USB device other than the keyboard, the mouse, and the camcorder from the computer.
- Disconnect the cable from the computer and camcorder, restart the computer, then connect them again correctly.

Cannot use the supplied software, Picture Motion Browser, on the Macintosh computer.

- You cannot use Picture Motion Browser on a Macintosh.

Cannot view the movies on a disc played on your camcorder on a computer monitor.

- Make sure you insert the connector in the correct direction, then connect the USB cable to the USB jack on your camcorder firmly.
- Select [COMPUTER], then [COMPUTER] on the HOME MENU (p. 61).
- Disconnect the USB device other than the keyboard, the mouse, and the camcorder from the computer.

You cannot view the still images recorded on a “Memory Stick Duo” on the computer.

- Insert the “Memory Stick Duo” firmly.
- Select [COMPUTER], then [COMPUTER] on the HOME MENU (p. 61).
- The computer does not recognize the “Memory Stick Duo” during camcorder operation such as disc playback or editing. Finish camcorder operation before connecting the camcorder to the computer.

The “Memory Stick” icon () does not appear on the computer screen.

- Insert a “Memory Stick Duo” into your camcorder.
- Disconnect the USB device other than the keyboard, the mouse, and the camcorder from the computer.
- Select [COMPUTER], then [COMPUTER] on the HOME MENU (p. 61).
- The computer does not recognize the “Memory Stick Duo” during camcorder operation such as disc playback or editing. Finish camcorder operation before connecting the camcorder to the computer.

Picture Motion Browser does not function correctly.

- Close Picture Motion Browser, then restart the Windows computer.

An error message appears while operating Picture Motion Browser.

- Close Picture Motion Browser on your Windows computer first, then set the POWER switch on your camcorder to another mode.

The movie, still image or sound of your camcorder is not played on your computer correctly.

- If your camcorder is connected to a computer that does not support Hi-speed USB (USB2.0), the movie, still image or sound may not be played back correctly. The movie, still image or sound copied to your computer is not affected.
- Movie playback or sound may stop temporarily depending on your computer. The movie or sound copied to your computer is not affected.

Cannot write from your computer to a disc in your camcorder.

- Use recommended discs. For details, see page 16.
- You cannot write to the DVD drive of your camcorder from software other than Picture Motion Browser.

The file transferred from the computer is not written to the “Memory Stick Duo” in your camcorder.

- The USB cable (supplied) is not removed with the right procedure. Connect your camcorder to the computer again and transfer the data.

The playback screen is paused or distorted.

- If the recorded disc is played back in your camcorder connected to a computer, the image may not play back smoothly, depending on the transfer speed. Insert the disc into the DVD drive of your computer for smooth playback.
- Check the computer environment required to play movies (p. 96).
- Close all application except “Player for AVCHD” on a computer.

A disc cannot be played back.

- Use the supplied “Player for AVCHD” software to play a disc recorded with HD (high definition) image quality. A standard disc player cannot be used. If other disc player software starts up when a disc recorded with HD (high definition) image quality is inserted in the computer, close that software.

The actually displayed screen or message is different from that shown in the “First Step Guide.”

- The screen or message may be different.

Warning indicators and messages

Self-diagnosis display/Warning indicators

If indicators appear on the LCD screen or in the viewfinder, check the following. Some symptoms you can fix by yourself. If the problem persists even after you have tried a couple of times, contact your Sony dealer or local authorized Sony service facility.

C:(or E:) □□:□□ (Self-diagnosis display)

C:04:□□

- The battery pack is not an “InfoLITHIUM” battery pack. Use an “InfoLITHIUM” battery pack (p. 130).
- Connect the DC plug of the AC Adaptor to the DC IN jack of your camcorder securely (p. 26).

C:13:□□

- The disc is faulty. Use a compatible disc with your camcorder (p. 16).
- The disc is dirty or has scratches on it. Clean the disc with a soft cloth (p. 126).

C:21:□□

- Moisture condensation has occurred. Turn off your camcorder and leave your camcorder for at least 1 hour (p. 132).

C:32:□□

- Symptoms that are not described above have occurred. Remove and insert the disc, then operate your camcorder again.
- Remove the power source. Reconnect it and operate your camcorder again.
- Turn on your camcorder again.

E:20:□□ / E:31:□□ / E:40:□□ / E:61:□□ / E:62:□□ / E:91:□□ / E:94:□□

- A malfunction that you cannot service has occurred. Contact your Sony dealer or local authorized Sony service facility. Inform them of the 5-digit code, which starts from “E.”

100-0001 (Warning indicator pertaining to files)

Slow flashing

- The file is damaged.
- The file is unreadable.

(Warning indicator pertaining to discs)

Slow flashing

- No disc is inserted.*
- Less than 5 minutes remains for recording movies.

Fast flashing

- An unrecognizable disc is inserted.*
- A finalized disc is inserted into your camcorder during recording standby.
- The disc is fully recorded.*
- The disc cannot be read or written, because the single-sided disc is inserted inside out.
- The disc recorded in the different TV color system from your camcorder is inserted when  (Movie) is selected.*

(You need to remove the disc)*

Fast flashing

- An unrecognizable disc is inserted.
- The disc is fully recorded.
- An error might have occurred with the disc drive in your camcorder.
- A finalized disc is inserted into your camcorder (p. 66).

(Battery level warning)

Slow flashing

- The battery pack is nearly used up.
- Depending on the operating, environment, or battery conditions,  may flash, even if there are approximately 20 minutes remaining.

 (Moisture condensation warning)***Slow flashing**

- Remove the power source, and then leave it for about 1 hour (p. 132).

 (High temperature warning)**Slow flashing**

- The temperature of your camcorder is getting higher. Turn off your camcorder and leave it for a while in a cool place.

Fast flashing*

- The temperature of your camcorder is extremely high. Turn off your camcorder and leave it for a while in a cool place.

 (Warning indicator pertaining to “Memory Stick Duo”)

- No “Memory Stick Duo” is inserted (p. 35).

 (Warning indicators pertaining to “Memory Stick Duo” formatting)*

- The “Memory Stick Duo” is damaged.
- The “Memory Stick Duo” is not formatted correctly (p. 73, 128).

 (Warning indicator pertaining to incompatible “Memory Stick Duo”)*

- An incompatible “Memory Stick Duo” is inserted (p. 73, 128).

  (Warning indicator pertaining to the write-protect of the “Memory Stick Duo”)*

- The write-protect tab on the “Memory Stick Duo” is set to lock (p. 128).
- Access to the “Memory Stick Duo” was restricted on another device.

 (Warning indicator pertaining to the flash)**Slow flashing:**

- Still charging

Fast flashing:

- There is something wrong with the flash.

 (Warning indicator pertaining to camera-shake warning)

- The amount of lights is not sufficient, so camera-shake easily occurs. Use the flash.
- The camcorder is unsteady, so camera-shake easily occurs. Hold the camcorder steady with both hands and shoot the image. However, note that the camera-shake warning indicator does not disappear.

* You hear a melody when the warning indicators appear on the screen (p. 85).

Description of warning messages

If messages appear on the screen, follow the instructions.

 Drive** Drive error. Turn on power again.**

- A problem may have occurred with the disc drive. Turn off and then on again.

 Moisture condensation** Moisture condensation. Turn off for 1H. (p. 132)**** Condensation. Cannot open. Remove disc later. (p. 132)**

■ Disc

 **Overheated. Recording on disc disabled.**

 **Overheated. Cannot open. Try later.**

 **Overheated. Cannot activate function. Wait a while and try again later.**

 **Recording on disc disabled.**

- A malfunction has occurred with the disc and the disc cannot be used.
-

 **Scene number on disc is full.**

- Delete unnecessary scenes (p. 54).
-

 **Disc full. Cannot record.**

- Delete unnecessary scenes (p. 54).
-

Playback prohibited.

- You are trying to play back an incompatible disc with your camcorder.
 - You are trying to play back an image recorded with a copyright protection signal.
-

 **Disc finalized. Cannot record on disc.**

- A finalized DVD-R/DVD+R DL cannot be recorded. Use a new disc.
-

 **Disc finalized. Function is not available.**

 **Need to unfinalize disc.**

- To record on the finalized DVD+RW/DVD-RW (VIDEO mode in the case of SD (standard definition) image quality), unfinalize it (p. 74).
-

Records movies in 16:9. Format to set. (p. 72)

Records movies in 4:3. Format to set. (p. 72)

 **Disc error. Remove disc.**

- Your camcorder cannot recognize the disc, because the disc is incompatible, has scratches, or is set wrongly, etc.
-

 **Disc error. Unsupported format.**

- The disc recorded in the different format code from your camcorder. Formatting the disc may enable you to use the disc on your camcorder (DVD-RW/DVD+RW only) (p.72).
-

Data error.

- An error occurred during reading or writing the disc.
-

Access error.

- An error occurred during reading or writing the disc.
-

Cannot play back or edit playlist on this disc.

■ **“Memory Stick Duo”**

 **Reinsert the Memory Stick.**

- Reinsert the “Memory Stick Duo” a few times. If even then the indicator flashes, the “Memory Stick Duo” could be damaged. Try with another “Memory Stick Duo.”

This is a read-only Memory Stick.

- Insert a writable “Memory Stick Duo.”

❌ Incompatible type of Memory Stick.

- A type of “Memory Stick Duo” incompatible with your camcorder is inserted (p. 128).

❌ This Memory Stick is not formatted correctly.

- Check the format, then format the “Memory Stick Duo” with your camcorder if necessary (p. 73, 128).

Cannot record. The Memory Stick is full.

- Delete unnecessary images (p. 55).

Cannot record still pictures. (p. 107)

🔒 The Memory Stick is locked. Check the tab. (p. 128)

Memory Stick has been removed. Process canceled.

Memory Stick folders are full.

- You cannot create folders exceeding 999MSDCF. You cannot create or delete created folders using your camcorder.
- Format the “Memory Stick Duo” (p. 73), or delete them using your computer.

Do not eject the Memory Stick during writing.

Cannot save still picture.

- When using the Dual Rec function, do not remove the still image recording media from the camcorder until disc recording is finished and still image recording is complete (p. 40).

No more still pictures during movie recording.

- You are trying to record more than 3 still images, the maximum number that can be recorded at one time of recording with the Dual Rec function (p. 40).

■ PictBridge compliant printer

Check the connected device.

- Switch off the printer and switch it on again, then disconnect the USB cable and reconnect it.

Not connected to PictBridge compatible printer.

- Switch off the printer and switch it on again, then disconnect the USB cable and reconnect it.

Error. Cancel the task.

- Check the printer.

Cannot print. Check the printer.

- Switch off the printer and switch it on again, then disconnect the USB cable and reconnect it.

■ Flash

Charging... Cannot record still images.

- You are trying to record a still image while charging the flash (optional).

Flash cannot charge. Not available.

- There is something wrong with the flash.

Lens accessory attached. Cannot use flash. (p. 40)

■ Others

Please connect AC adaptor.

- When the battery is low, you are trying to finalize, format, or unfinalize a disc. Use the AC Adaptor as the power source to prevent the battery from wearing out in the middle of those operations.

Playlist full/No further selection is possible.

- You cannot create the playlist exceeding 999 scenes (p. 57).
- You can select up to 100 images for the playlist at one time (p. 57).

Data protected.

- The disc has been protected with another device.

Cannot divide.

- You cannot divided a movie that is extremely short.

Recovering data Avoid any vibration.

- Your camcorder tries to recover data automatically if the data writing was not performed properly.

Cannot recover data on disc.

- Writing data to the disc has failed. Attempts were made to recover the data, but they were unsuccessful.

Please wait.

- This is displayed if the disc removal process takes time. Turn on the camcorder and leave it for about 10 minutes, preventing vibration.

Possibility of problem with disc.

- The disc removal process has failed. There may be something wrong with the disc.
-

Using your camcorder abroad

Power supply

You can use your camcorder in any countries/regions using the AC Adaptor supplied with your camcorder within the AC 100 V to 240 V, 50/60 Hz range.

Viewing images recorded with HD (high definition) image quality

In countries/regions where 1080/50i is supported, you can view the images with the same HD (high definition) image quality as that of the recorded images. You need a PAL-system-based and 1080/50i compatible TV (or monitor) with component and AUDIO/VIDEO input jacks. Both a component video cable and an A/V connecting cable must be connected.

Viewing images recorded with SD (standard definition) image quality

To view images recorded with SD (standard definition) image quality, you need a PAL-system-based TV with AUDIO/VIDEO input jacks. An A/V connecting cable must be connected.



On TV color systems

Your camcorder is a PAL-system-based camcorder. If you want to view the playback image on a TV, it must be a PAL-system-based TV with an AUDIO/VIDEO input jack.

System	Used in
PAL	Australia, Austria, Belgium, China, Czech Republic, Denmark, Finland, Germany, Holland, Hong Kong, Hungary, Italy, Kuwait, Malaysia, New Zealand, Norway, Poland, Portugal, Singapore, Slovak Republic, Spain, Sweden, Switzerland, Thailand, United Kingdom, etc.
PAL - M	Brazil
PAL - N	Argentina, Paraguay, Uruguay.
NTSC	Bahama Islands, Bolivia, Canada, Central America, Chile, Colombia, Ecuador, Guyana, Jamaica, Japan, Korea, Mexico, Peru, Surinam, Taiwan, the Philippines, the U.S.A., Venezuela, etc.
SECAM	Bulgaria, France, Guiana, Iran, Iraq, Monaco, Russia, Ukraine, etc.

Using your camcorder abroad (Continued)

Setting to the local time

You can easily set the clock to the local time by setting a time difference when using your camcorder abroad. Set  (SETTINGS) → [CLOCK/LANG] → [AREA SET] and [SUMMERTIME] on the HOME MENU (p. 31).

World time difference

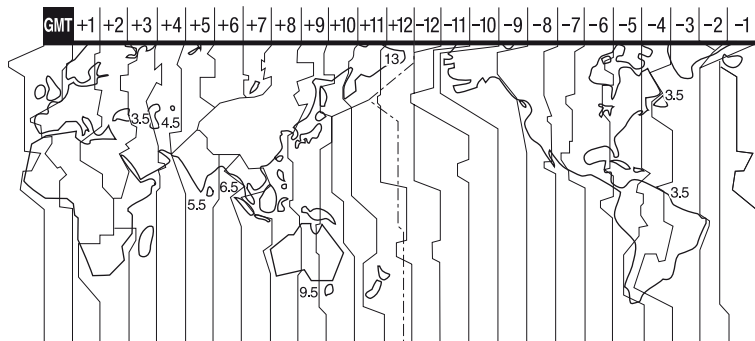

Time-zone differences	Area setting
GMT	Lisbon, London
+01:00	Berlin, Paris
+02:00	Helsinki, Cairo, Istanbul
+03:00	Moscow, Nairobi
+03:30	Tehran
+04:00	Abu Dhabi, Baku
+04:30	Kabul
+05:00	Karachi, Islamabad
+05:30	Calcutta, New Delhi
+06:00	Almaty, Dhaka
+06:30	Rangoon
+07:00	Bangkok, Jakarta
+08:00	HongKong, Singapore, Beijing
+09:00	Seoul, Tokyo
+09:30	Adelaide, Darwin
+10:00	Melbourne, Sydney

Time-zone differences	Area setting
+11:00	Solomon Is.
+12:00	Fiji, Wellington
-12:00	Eniwetok, Kwajalein
-11:00	Midway Is., Samoa
-10:00	Hawaii
-09:00	Alaska
-08:00	LosAngeles, Tijuana
-07:00	Denver, Arizona
-06:00	Chicago, Mexico City
-05:00	New York, Bogota
-04:00	Santiago
-03:30	St. John's
-03:00	Brasilia, Montevideo
-02:00	Fernando de Noronha
-01:00	Azores, Cape Verde Is.

About the Disc

See page 16 for the details of discs which you can use with your camcorder.

Notes on use

- Hold the disc by its edge while supporting the center hole lightly. Do not touch the recording side (the opposite of the printed side when using a single-sided disc).



- Before shooting, be sure to remove dust and fingerprints from the disc with a soft cloth. Otherwise you may not be able to record or play normally in some situations using that disc.
- When you set the disc in your camcorder, press firmly until it clicks. When the message [C:13:□□] appears on the LCD screen, open the disc cover and set the disc again.
- Do not attach any adhesive material such as a sticker on the surface of a disc. If you do so, the disc may become unbalanced, and this may cause a malfunction of the disc or your camcorder.



Use of double-sided discs

Double-sided discs allow you to record both sides of a disc.

■ Recording on the A side

Place the disc in your camcorder with the side with the **A** symbol at the center facing outwards until it clicks.

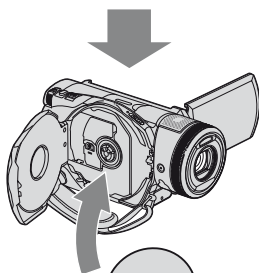
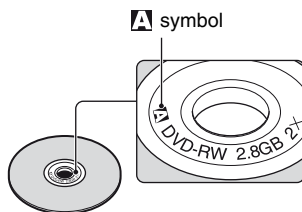

Place the **A** symbol facing outwards.
Recording is made on the rear side.

- When using a double-sided disc, take care not to smudge the surface with fingerprints.
- When a double-sided disc is used in your camcorder, recording/playback are performed on that side only. You cannot switch to record on or play back the other side with the disc set to the camcorder. When recording/playback of one side is complete, remove the disc and turn it over to access the other side.
- Perform the following operations on each side of a double-sided disc:
 - Finalizing (p. 66)
 - Unfinalizing (p. 74)
 - Formatting (p. 72)

About the Disc (Continued)

Care and storage of the discs

- Keep the disc clean, or the image quality of the audio and video output may deteriorate.
- Clean the disc with a soft cloth. Wipe the disc from the center out. For dirt, clean the disc with a soft cloth slightly moistened in water, then remove the moisture with a soft, dry cloth. Do not use solvents such as benzine, cleaners intended for vinyl LPs or antistatic spray, as they may cause a malfunction to the disc.



- Do not expose the disc to direct sunlight or leave it in a humid place.
- When you carry or store the disc, put it in its case.
- When you want to write letters or marks, etc. on a single-sided disc, write only on the printed side using an oil-based marker with a felt-tip, and do not touch the ink until it dries. Do not heat the disc or use a sharp-pointed tool, such as ball point pen. Do not dry the surface by heating. You cannot write, or mark, on double-sided discs.

About the AVCHD format

Your digital video camera recorder incorporates both the AVCHD format and the DVD format for the recording function.

What is the AVCHD format?

The AVCHD format is a high definition digital video camera format used to record an HD (high definition) signal of either the 1080i specification*¹ or the 720p specification*², using efficient data compression coding technology. The MPEG-4 AVC/H.264 format is adopted to compress video data, and the Dolby Digital or Linear PCM system is used to compress audio data.

The MPEG-4 AVC/H.264 format is capable of compressing images at higher efficiency than that of the conventional image compressing format. The MPEG-4 AVC/H.264 format enables a high definition (HD) video signal shot on a digital video camera recorder to be recorded on 8 cm DVD discs.

Recording and playback on your camcorder

Based on the AVCHD format, your camcorder records with the HD (high definition) image quality mentioned below.

Video signal:

AVCHD format 1440 × 1080/50i

Audio signal:

Dolby Digital 5.1 ch

Recording media:

8 cm DVD-RW, DVD-R, DVD+RW, DVD+R DL discs

- DVDs recorded in AVCHD format other than the above mentioned cannot be played on your camcorder. 8 cm DVD-RAM discs cannot be recorded or played on your camcorder.

In addition to HD (high definition) image quality, your camcorder is capable of recording an SD (standard definition) signal in the conventional DVD format.

*1: 1080i specification

A high definition specification which utilizes 1080 effective scanning lines and the interlace system.

*2: 720p specification

A high definition specification which utilizes 720 effective scanning lines and the progressive system.

About the “Memory Stick”

A “Memory Stick” is a compact, portable IC recording medium with a data capacity that exceeds the capacity of a floppy disk. You can use only a “Memory Stick Duo,” which is about the half size of a standard “Memory Stick” with your camcorder. However, we do not guarantee the operation of all types of “Memory Stick Duo” on your camcorder. (See the list below for more details.)

Types of “Memory Stick”	Recording/ Playback
“Memory Stick” (without MagicGate)	–
“Memory Stick Duo” ^{*1} (without MagicGate)	○
“MagicGate Memory Stick”	–
“Memory Stick Duo” ^{*1} (with MagicGate)	○ ^{*2*3}
“MagicGate Memory Stick Duo” ^{*1}	○ ^{*3}
“Memory Stick PRO”	–
“Memory Stick PRO Duo” ^{*1}	○ ^{*2*3}

^{*1} A “Memory Stick Duo” is about half the size of a standard “Memory Stick.”

^{*2} The types of “Memory Stick” that support high speed data transfer. The speed of data transfer varies depending on the device to be used.

^{*3} “MagicGate” is a copyright protection technology that records and transfers the contents in an encrypted format. Note that data that uses “MagicGate” technology cannot be recorded or played on your camcorder.

- Still image format: Your camcorder compresses and records image data in the JPEG (Joint Photographic Experts Group) format. The file extension is “.JPG.”
- File names of still images:
 - 101- 0001: This file name appears on the screen of your camcorder.
 - DSC00001.JPG: This file name appears on the display of a computer.
- A “Memory Stick Duo” formatted by a computer (Windows OS/Mac OS) does not have guaranteed compatibility with your camcorder.

- Data read/write speed may vary depending on the combination of the “Memory Stick” and “Memory Stick” compliant product you use.

On a “Memory Stick Duo” with a write-protect tab

You can prevent accidental erasure of images when you slide the write-protect tab on the “Memory Stick Duo” with a small tapered object, to the write-protect position.

Notes on use

Damaged or lost image data will not be compensated for, and may occur in the following cases:

- If you eject the “Memory Stick Duo,” turn the power off on your camcorder, or remove the battery pack for replacement while your camcorder is reading or writing image files on the “Memory Stick Duo” (while the access lamp is lit or flashing).
- If you use the “Memory Stick Duo” near magnets or magnetic fields.

It is recommended you make a back-up of important data on the hard disk of a computer.

■ On handling a “Memory Stick”

Keep the following in mind when handling a “Memory Stick Duo.”

- Be careful not to apply excessive force when writing on a memo area on a “Memory Stick Duo.”
- Do not attach a label or the like on a “Memory Stick Duo” or a Memory Stick Duo adaptor.
- When you carry or store a “Memory Stick Duo,” put it in its case.
- Do not touch, or allow metallic objects to come into contact with the terminals.
- Do not bend, drop or apply strong force to the “Memory Stick Duo.”
- Do not disassemble or modify the “Memory Stick Duo.”
- Do not let the “Memory Stick Duo” get wet.
- Be careful to keep “Memory Stick Duo” media out of the reach of small children. There is danger that a child might swallow it.

- Do not insert anything other than a “Memory Stick Duo” into the “Memory Stick Duo” slot. Doing so may cause a malfunction.

■ On a location for use

Do not use or keep the “Memory Stick Duo” in the following locations:

- Places subject to extremely high temperature, such as a car parked outside in the summer.
- Places under direct sunlight.
- Places with extremely high humidity or subject to corrosive gases.

■ On the Memory Stick Duo adaptor

After inserting a “Memory Stick Duo” into the Memory Stick Duo adaptor, you can use it with a standard “Memory Stick” compliant device.

- When using a “Memory Stick Duo” with a “Memory Stick” compliant device, be sure to insert the “Memory Stick Duo” into a Memory Stick Duo adaptor.
- When inserting a “Memory Stick Duo” into a Memory Stick Duo adaptor, make sure the “Memory Stick Duo” is inserted facing in the correct direction, then insert it all the way in. Note that improper use may cause a malfunction. Also, if you force the “Memory Stick Duo” into the Memory Stick Duo adaptor in the wrong direction, it may be damaged.
- Do not insert a Memory Stick Duo adaptor without a “Memory Stick Duo” attached. Doing so may result in malfunctions of the unit.

■ On a “Memory Stick PRO Duo”

The maximum memory capacity of a “Memory Stick PRO Duo” that can be used on your camcorder is 2 GB.

On image data compatibility

- Image data files recorded on a “Memory Stick Duo” by your camcorder conform to the “Design rule for Camera File system” universal standard established by the JEITA (Japan Electronics and Information Technology Industries Association).
- On your camcorder, you cannot play back still images recorded on other devices (DCR-TRV900E or DSC-D700/D770) that do not conform to the universal standard. (These models are not sold in some regions.)
- If you cannot use a “Memory Stick Duo” that has been used with another device, format it with your camcorder (p. 73). Note that formatting erases all information on the “Memory Stick Duo.”
- You may not be able to play back images with your camcorder:
 - When playing back image data modified on your computer.
 - When playing back image data recorded with other devices.

About the “InfoLITHIUM” battery pack

Your camcorder operates only with an “InfoLITHIUM” battery pack (M series). “InfoLITHIUM” M series battery packs have the  mark.

What is an “InfoLITHIUM” battery pack?

An “InfoLITHIUM” battery pack is a lithium-ion battery pack that has functions for communicating information related to operating conditions between your camcorder and an optional AC Adaptor/charger.

The “InfoLITHIUM” battery pack calculates the power consumption according to the operating conditions of your camcorder, and displays the remaining battery time in minutes.

With an AC Adaptor/charger, the remaining battery time and charging time appear.

To charge the battery pack

- Be sure to charge the battery pack before you start using your camcorder.
- We recommend charging the battery pack in an ambient temperature of between 10 °C to 30 °C (50 °F to 86 °F) until the CHG (charge) lamp turns off. If you charge the battery pack outside of this temperature range, you may not be able to charge it efficiently.
- After charging is complete, disconnect the cable from the DC IN jack on your camcorder or remove the battery pack.

To use the battery pack effectively

- Battery pack performance decreases when the surrounding temperature is 10 °C (50 °F) or below, and the length of time you can use the battery pack becomes shorter. In that case, do one of the following to use the battery pack for a longer time.
 - Put the battery pack in a pocket to warm it up, and insert it in your camcorder right before you start taking shots.
 - Use a large capacity battery pack: NP-QM71D/QM91D (optional).
- Frequent use of the LCD screen or a frequent playback, fast forward or rewind operation wears out the battery pack faster.

We recommend using a large capacity battery pack: NP-QM71D/QM91D.

- Be sure to set the POWER switch to OFF (CHG) when not recording or playing back on your camcorder. The battery pack is also consumed when your camcorder is in recording standby or playback pause.
- Have spare battery packs ready for two or three times the expected recording time, and make trial recordings using a DVD-RW/DVD+RW before making the actual recording.
- Do not expose the battery pack to water. The battery pack is not water resistant.

About the remaining battery time indicator

- When the power goes off even though the remaining battery time indicator indicates that the battery pack has enough power to operate, charge the battery pack fully again. Remaining battery time will be indicated correctly. Note, however, that the battery indication will not be restored if it is used in high temperatures for a long time, or if left in a fully charged state, or when the battery pack is frequently used. Use the remaining battery time indication as a rough guide only.
- The  mark that indicates low battery flashes even if there are still 5 to 10 minutes of battery time remaining, depending on the operating conditions or ambient temperature.

About storage of the battery pack

- If the battery pack is not used for a long time, fully charge the battery pack and use it up on your camcorder once a year to maintain proper function. To store the battery pack, remove it from your camcorder and put it in a dry, cool place.
- To discharge the battery pack on your camcorder completely, touch  (SETTINGS) → [GENERAL SET] → [A.SHUT OFF] → [NEVER] on the HOME MENU and leave your camcorder in recording standby until the power goes off (p. 88).

Maintenance and precautions

About battery life

- Battery capacity decreases over time and through repeated use. If decreased usage time between charges becomes significant, it is probably time to replace it with a new one.
- Each battery's life is governed by storage, operating and environmental conditions.

On use and care

- Do not use or store the camcorder and accessories in the following locations:
 - Anywhere extremely hot or cold. Never leave them exposed to temperatures above 60 °C (140 °F), such as under direct sunlight, near heaters or in a car parked in the sun. They may malfunction or become deformed.
 - Near strong magnetic fields or mechanical vibration. The camcorder may malfunction.
 - Near strong radio waves or radiation. The camcorder may not be able to record properly.
 - Near AM receivers and video equipment. Noise may occur.
 - On a sandy beach or anywhere dusty. If sand or dust gets in your camcorder, it may malfunction. Sometimes this malfunction cannot be repaired.
 - Near windows or outdoors, where the LCD screen, the viewfinder, or the lens may be exposed to direct sunlight. This damages the inside of the viewfinder or the LCD screen.
 - Anywhere very humid.
- Operate your camcorder on DC 7.2 V (battery pack) or DC 8.4 V (AC Adaptor).
- For DC or AC operation, use the accessories recommended in these operating instructions.
- Do not let your camcorder get wet, for example, from rain or sea water. If your camcorder gets wet, it may malfunction. Sometimes this malfunction cannot be repaired.
- If any solid object or liquid gets inside the casing, unplug your camcorder and have it checked by a Sony dealer before operating it any further.
- Avoid rough handling, disassembling, modifying, physical shock, or impact such as hammering, dropping or stepping on the product. Be particularly careful of the lens.
- Keep the POWER switch setting to OFF (CHG) when you are not using your camcorder.
- Do not wrap your camcorder with a towel, for example, and operate it. Doing so might cause heat to build up inside.
- When disconnecting the mains lead, pull it by the plug and not the cord.
- Do not damage the mains lead such as by placing anything heavy on it.
- Keep metal contacts clean.



Maintenance and precautions (Continued)

- Keep the Remote Commander and button-type battery out of children's reach. If the battery is accidentally swallowed, consult a doctor immediately.
- If the battery electrolytic liquid has leaked:
 - consult your local authorized Sony service facility.
 - wash off any liquid that may have contacted your skin.
 - if any liquid gets in your eyes, wash with plenty of water and consult a doctor.

■ When not using your camcorder for a long time

- Periodically turn it on and let it run such as by playing back discs or recording for about 3 minutes.
- Remove a disc from your camcorder.
- Use up the battery pack completely before storing it.

Moisture condensation

If your camcorder is brought directly from a cold place to a warm place, moisture may condense inside your camcorder, on the surface of the disc, or on the pickup lens. This may cause a malfunction to your camcorder. If there is moisture inside your camcorder, [ Moisture condensation. Turn off for 1H.] or [ Condensation. Cannot open. Remove disc later.] appears. The indication will not appear when the moisture condenses on the camera lens.

■ If moisture condensation has occurred

Leave your camcorder for about 1 hour without turning it on.

■ Note on moisture condensation

Moisture may condense when you bring your camcorder from a cold place into a warm place (or vice versa) or when you use your camcorder in a humid place as follows:

- You bring your camcorder from a ski slope into a place warmed up by a heating device.
- You bring your camcorder from an air conditioned car or room into a hot place outside.
- You use your camcorder after a squall or a shower.
- You use your camcorder in a hot and humid place.

■ How to prevent moisture condensation

When you bring your camcorder from a cold place into a warm place, put your camcorder in a plastic bag and seal it tightly. Remove the bag when the air temperature inside the plastic bag has reached the surrounding temperature (after about 1 hour).

LCD screen



- Do not exert excessive pressure on the LCD screen, as it may cause damage.
- If your camcorder is used in a cold place, a residual image may appear on the LCD screen. This is not a malfunction.
- While using your camcorder, the back of the LCD screen may heat up. This is not a malfunction.

■ To clean the LCD screen

If fingerprints or dust make the LCD screen dirty, it is recommended you use a soft cloth to clean it. When you use the LCD Cleaning Kit (optional), do not apply the cleaning liquid directly to the LCD screen. Use cleaning paper moistened with the liquid.

■ On adjustment of the LCD screen (CALIBRATION)

The buttons on the touch panel may not work correctly. If this happens, follow the procedure below. It is recommended that you connect your camcorder to the wall socket using the supplied AC Adaptor during the operation.

- ① Turn on your camcorder, then press  (HOME).
- ② Disconnect cables other than that of the AC Adaptor from your camcorder, then eject the disc and "Memory Stick Duo" from your camcorder.
- ③ Touch  (SETTINGS) → [GENERAL SET] → [CALIBRATION].

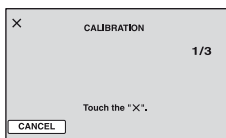

- ④ Touch “x” displayed on the screen with the corner of the “Memory Stick Duo” or the like. The position of “x” changes. Touch [CANCEL] to cancel.

If you did not press the right spot, try the calibration again.

Notes

- Do not use a sharp-pointed object for calibration. Doing so may damage the LCD screen.
- You cannot calibrate the LCD screen if it is rotated, or closed with the screen facing out.

On handling the casing

- If the casing is soiled, clean the camcorder body with a soft cloth lightly moistened with water, and then wipe the casing with a dry soft cloth.
- Avoid the following to avoid damage to the finish:
 - Using chemicals such as thinner, benzene, alcohol, chemical cloths, repellent, insecticide and sunscreen.
 - Handling the camcorder with above substances on your hands.
 - Leaving the casing in contact with rubber or vinyl objects for a long period of time.

On the pickup lens

- Do not touch the lens inside the disc cover. Keep the disc cover closed except when inserting and removing the disc, to keep dust out.
- When your camcorder does not work because the pickup lens is dirty, clean it with a blower (not supplied). Do not touch the pickup lens directly during cleaning because this may cause the camcorder to malfunction.

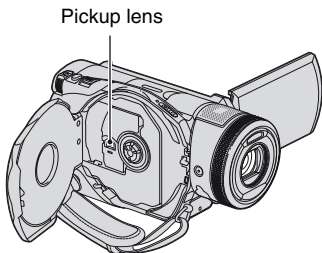

Pickup lens  Glossary (p. 147)

About care and storage of the lens

- Wipe the surface of the lens clean with a soft cloth in the following instances:
 - When there are fingerprints on the lens surface.
 - In hot or humid locations
 - When the lens is exposed to salty air such as at the seaside.
- Store in a well-ventilated location subject to little dirt or dust.
- To prevent mold, periodically clean the lens as described above. It is recommended that you operate your camcorder about once a month to keep it in optimum state for a long time.

On charging the pre-installed rechargeable battery

Your camcorder has a pre-installed rechargeable battery to retain the date, time, and other settings even when the POWER switch is set to OFF (CHG). The pre-installed rechargeable battery is always charged while your camcorder is connected to the wall socket via the AC Adaptor or while the battery pack is attached. The rechargeable battery will be fully discharged in about **4 months** if you do not use your camcorder at all. Use your camcorder after charging the pre-installed rechargeable battery. However, even if the pre-installed rechargeable battery is not charged, the camcorder operation will not be affected as long as you are not recording the date.

■ Procedures

Connect your camcorder to a wall socket using the supplied AC Adaptor, and leave it with the POWER switch set to OFF (CHG) for more than 24 hours.

To change the battery of the Remote Commander

- ① While pressing on the tab, inset your fingernail into the slit to pull out the battery case.
- ② Place a new battery with the + side facing up.
- ③ Insert the battery case back into the Remote Commander until it clicks.

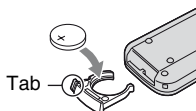

WARNING

Battery may explode if mistreated. Do not recharge, disassemble or dispose of in fire.

- When the lithium battery becomes weak, the operating distance of the Remote Commander may shorten, or the Remote Commander may not function properly. In this case, replace the battery with a Sony CR2025 lithium battery. Use of another battery may present a risk of fire or explosion.

System

Video compression format

AVCHD (HD)/MPEG2 (SD)/JPEG
(Still images)

Audio compression format

Dolby Digital 2/5.1ch
Dolby Digital 5.1 Creator

Video signal

PAL color, CCIR standards
1080/50i specification

Usable discs

8 cm DVD-R/DVD+R DL/DVD-RW/
DVD+RW

Recording format

Movie

HD:

AVCHD 1080/50i

SD:

DVD-R/DVD+R DL: DVD-VIDEO

DVD-RW: DVD-VIDEO (VIDEO
mode), DVD-Video Recording (VR
mode)

DVD+RW: DVD+RW Video

Still image

Exif Ver.2.2¹

Recording time

DVD-R/DVD-RW/DVD+RW:

AVC HD 12M (HQ+): Approx. 15 min

AVC HD 9M (HQ): Approx. 20 min

AVC HD 7M (SP): Approx. 25 min

AVC HD 5M (LP): Approx. 32 min

SD 9M (HQ): Approx. 20 min

SD 6M (SP): Approx. 30 min

SD 3M (LP): Approx. 60 min

DVD+R DL:

AVC HD 12M (HQ+): Approx. 27 min

AVC HD 9M (HQ): Approx. 35 min

AVC HD 7M (SP): Approx. 45 min

AVC HD 5M (LP): Approx. 60 min

SD 9M (HQ): Approx. 35 min

SD 6M (SP): Approx. 55 min

SD 3M (LP): Approx. 110 min

Viewfinder

Electric viewfinder (color)

Image device (ClearVid CMOS Sensor)

CMOS: 5.9 mm (1/3 type)

Recording pixels (still, 4:3):

Max. 4.0 mega (2 304 × 1 728) pixels*²

Gross: Approx. 2 100 000 pixels

Effective (movie, 16:9):

1 430 000 pixels

Effective (movie, 4:3):

1 080 000 pixels

Effective (still, 16:9):

1 490 000 pixels

Effective (still, 4:3):

1 990 000 pixels

Lens

Carl Zeiss Vario-Sonnar T*

10 × (Optical), 20 ×, 80 × (Digital)

Filter diameter: 30 mm (1 3/16 in.)

Focal length

F1.8 ~ 2.9

f=5.1 ~ 51 mm (7/32 ~ 2 1/8 in.)

When converted to a 35 mm still camera

For movies *³: 41.3 ~ 485 mm (1 11/16 ~ 19 1/8 in.) (16:9), 50.5 ~ 594 mm (2 ~ 23 1/2 in.) (4:3)

For still images: 40.4 ~ 404 mm (1 5/8 ~ 16 in.) (16:9), 37 ~ 370 mm (1 1/2 ~ 14 5/8 in.) (4:3)

Color temperature

[AUTO], [ONE PUSH],

[INDOOR] (3 200 K),

[OUTDOOR] (5 800 K)

Minimum illumination

5 lx (lux) (F 1.8)

0 lx (lux) (during NightShot function)

*1“Exif” is a file format for still images, established by the JEITA (Japan Electronics and Information Technology Industries Association). Files in this format can have additional information

such as your camcorder’s setting information at the time of recording.

*²The unique pixel array of Sony’s ClearVid CMOS Sensor and image processing system (new Enhanced Imaging Processor) allow still image resolution equivalent to twice that of the image sensor’s effective pixel count.

*³The focal length figures are actual figures resulting from wide angle pixel readout.

- Manufactured under license from Dolby Laboratories.

Input/Output connectors

Audio/Video output

10-pin connector

Video signal: 1 Vp-p, 75 Ω (ohms), unbalanced

Luminance signal: 1 Vp-p, 75 Ω (ohms), unbalanced

Chrominance signal: 0.3 Vp-p, 75 Ω (ohms), unbalanced

Audio signal: 327 mV (at load impedance 47 kΩ (kilohms)), Output impedance with less than 2.2 kΩ (kilohms)

COMPONENT OUT jack

Y: 1 Vp-p, 75Ω (ohms), unbalanced
PB/PR, CB/CR: +/- 350 mVp-p

HDMI OUT jack

Type A (19-pin)

Headphone jack

Stereo minijack (Ø 3.5 mm)

USB jack

mini-B

MIC input jack

Stereo minijack (Ø 3.5 mm)

REMOTE jack

Stereo mini-minijack (Ø 2.5 mm)

Specifications (Continued)

LCD screen

Image

8.8 cm (3.5 type, aspect ratio 16:9)

Total dot number

211 200 (960 × 220)

General

Power requirements

DC 7.2 V (battery pack)

DC 8.4 V (AC Adaptor)

Average power consumption

During camera recording using the viewfinder with normal brightness:

4.9 W

During camera recording using the LCD with normal brightness:

5.0 W

Operating temperature

0 °C to + 40 °C (32 °F to 104 °F)

Storage temperature

-20 °C to + 60 °C (-4 °F to + 140 °F)

Dimensions (approx.)

76 × 89 × 165 mm

(3 × 3 5/8 × 6 1/2 in.) (w/h/d)

including the projecting parts

76 × 89 × 165 mm

(3 × 3 5/8 × 6 1/2 in.) (w/h/d)

including the projecting parts, the NP-FM50 rechargeable battery pack attached

Mass (approx.)

660 g (1 lb 7 oz) main unit only

740 g (1 lb 10 oz) including the NP-FM50 rechargeable battery pack and a disc

Supplied accessories

See page 25.

AC Adaptor AC-L15A

Power requirements

AC 100 - 240 V, 50/60 Hz

Current consumption

0.35 - 0.18 A

Power consumption

18 W

Output voltage

DC 8.4 V*

Operating temperature

0 °C to + 40 °C (32 °F to 104 °F)

Storage temperature

-20 °C to + 60 °C (-4 °F to + 140 °F)

Dimensions (approx.)

56 × 31 × 100 mm (2 1/4 × 1 1/4 × 4 in.)

(w/h/d) excluding the projecting parts

Mass (approx.)

190 g (6.7 oz) excluding the mains lead

* See the label on the AC Adaptor for other specifications.

Rechargeable battery pack (NP-FM50)

Maximum output voltage

DC 8.4 V

Output voltage

DC 7.2 V

Capacity

8.5 Wh (1 180 mAh)

Dimensions (approx.)

38.2 × 20.5 × 55.6 mm

(1 9/16 × 13/16 × 2 1/4 in.) (w/h/d)

Mass (approx.)

76 g (2.7 oz)

Operating temperature





0 °C to + 40 °C (32 °F to 104 °F)

Type

Lithium ion

Design and specifications are subject to change without notice.

On trademarks

- “Handycam” and  are registered trademarks of Sony Corporation.
- “AVCHD” and “AVCHD” logotype are trademarks of Matsushita Electric Industrial Co., Ltd. and Sony Corporation.
- “Memory Stick,” , “Memory Stick Duo,” , “Memory Stick PRO Duo,” , “MagicGate,” , “MagicGate Memory Stick” and “MagicGate Memory Stick Duo” are trademarks of Sony Corporation.
- “InfoLITHIUM” is a trademark of Sony Corporation.
- DVD-R, DVD+R DL, DVD-RW, and DVD+RW logo are trademarks.
- Dolby and the double-D symbol are trademarks of Dolby Laboratories.
- Dolby Digital 5.1 Creator is a trademark of Dolby Laboratories.
- Microsoft, Windows, and Windows Media are trademarks or registered trademarks of U.S. Microsoft Corporation in the U.S. and other countries.
- Macintosh and Mac OS are trademarks of Apple Computer, Inc in the U.S. and other countries.
- HDMI, the HDMI logo and High-Definition Multimedia Interface are trademarks or registered trademarks of HDMI Licensing LLC.
- Pentium is a trademark or registered trademark of Intel Corporation.

All other product names mentioned herein may be the trademarks or registered trademarks of their respective companies. Furthermore, ™ and “®” are not mentioned in each case in this manual.

Notes on the License

ANY USE OF THIS PRODUCT OTHER THAN CONSUMER PERSONAL USE IN ANY MANNER THAT COMPLIES WITH THE MPEG-2 STANDARD FOR ENCODING VIDEO INFORMATION FOR PACKAGED MEDIA IS EXPRESSLY PROHIBITED WITHOUT A LICENSE UNDER APPLICABLE PATENTS IN THE MPEG-2 PATENT PORTFOLIO, WHICH LICENSE IS AVAILABLE FROM MPEG LA, L.L.C., 250 STEELE STREET, SUITE 300, DENVER, COLORADO 80206.

THIS PRODUCT IS LICENSED UNDER THE AVC PATENT PORTFOLIO LICENSE FOR THE PERSONAL AND NON-COMMERCIAL USE OF A CONSUMER TO

(i) ENCODE VIDEO IN COMPLIANCE WITH THE AVC STANDARD (“AVC VIDEO”) AND / OR



(ii) DECODE AVC VIDEO THAT WAS ENCODED BY A CONSUMER ENGAGED IN A PERSONAL AND NON-COMMERCIAL ACTIVITY AND/OR WAS OBTAINED FROM A VIDEO PROVIDER LICENSED TO PROVIDE AVC VIDEO. NO LICENSE IS GRANTED OR SHALL BE IMPLIED FOR ANY OTHER USE.

ADDITIONAL INFORMATION MAY BE OBTAINED FROM MPEG LA, L.L.C. SEE <[HTTP://MPEGLA.COM](http://MPEGLA.COM)>

Identifying parts and controls

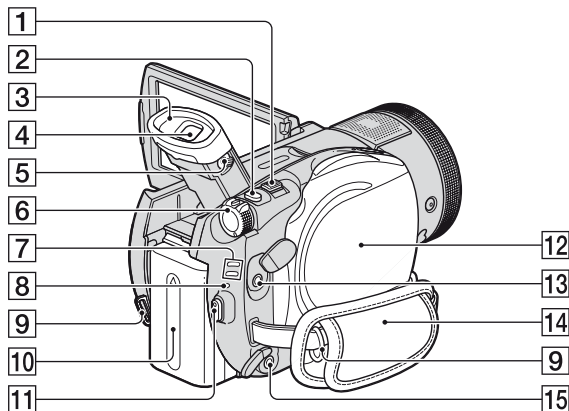
The numbers in () are reference pages.



- 1** Power zoom lever (39, 47)
- 2** PHOTO button (38)
- 3** Eyecup
- 4** Viewfinder (31)
- 5** Viewfinder lens adjustment lever (31)
- 6** POWER switch (29)
- 7**  (Movie)/  (Still) mode lamps (29)
- 8** CHG (charge) lamp (26)
- 9** Hooks for a shoulder belt
Attach a shoulder belt (optional).
- 10** Battery pack (26)
- 11** START/STOP button (37)
- 12** Disc cover (33)
- 13**  (headphones) jack
- 14** Grip belt (36)
- 15** REMOTE jack

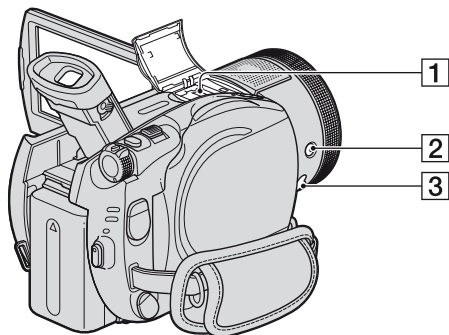

- 1** Active Interface Shoe Active Interface Shoe (39)
 The Active Interface Shoe supplies power to optional accessories such as a video light, a flash, or a microphone. The accessory can be turned on or off as you operate the POWER switch on your camcorder. Refer to the operating instructions supplied with your accessory for details.

The Active Interface Shoe has a safety device for fixing the installed accessory securely. To connect an accessory, press down and push it to the end, and then tighten the screw. To remove an accessory, loosen the screw, and then press down and pull out the accessory.

- When you are recording movies with an external flash (optional) connected to the accessory shoe, turn off the power of the external flash to prevent charging noise being recorded.
- You cannot use an external flash (optional) and the built-in flash at the same time.
- When an external microphone (optional) is connected, it takes precedence over the internal microphone (p. 39).

- 2**  (flash) button (40)

- 3** MIC (PLUG IN POWER) jack
 When an external microphone (optional) is connected, it takes precedence over the internal microphone (p. 39).

Identifying parts and controls (Continued)

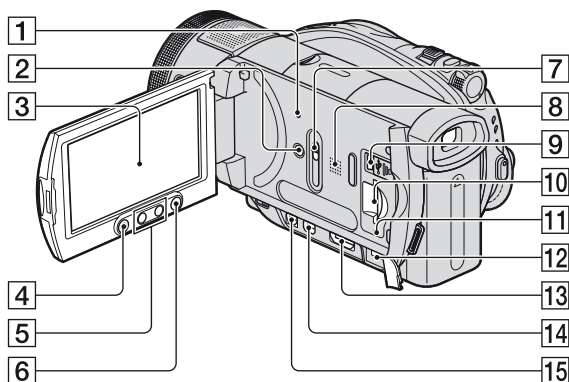

1 RESET button
Initializes all the settings, including the setting of the date and time.

2 DISP/BATT INFO button (27)

3 LCD screen/touch panel (18, 30)

4 START/STOP button (37)

5 Zoom buttons (39, 47)

6  (HOME) button (20, 76)

7 JACK COVER OPEN/CLOSE knob

8 Speaker
Playback sounds come out from the speaker. For how to adjust the volume, see page 45.

9  (USB) jack (63)

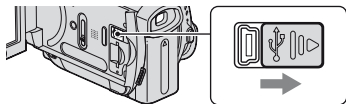

10 “Memory Stick Duo” slot (35)

11 Access lamp (35)

12 DC IN jack (26)

13 HDMI OUT jack (50)

14 COMPONENT OUT jack (49)

15 A/V OUT jack (52)

To open the jack cover

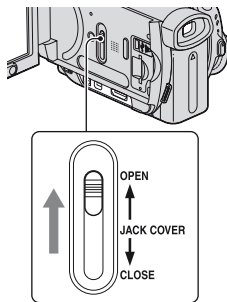

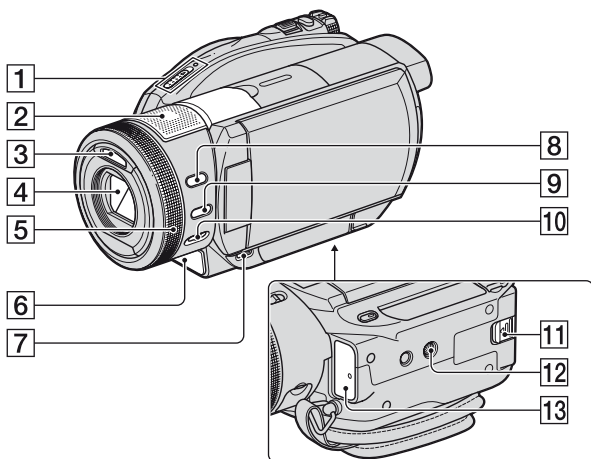

- 1** Disc cover OPEN switch/ACCESS lamp (33)
- 2** Internal 4ch microphone (39)
An Active Interface Shoe compatible microphone (optional) will take precedence when connected.
- 3** Flash (40)
- 4** Lens (Carl Zeiss Lens) (5)
- 5** Camera control ring (42)
- 6** Camera recording lamp (36)
Lights up in red during recording.
Flashes when remaining disc space or battery power is low.
- 7**  (VIEW IMAGES) button (44)
- 8** BACK LIGHT button (41)
- 9** MANUAL button (42)
- 10** NIGHTSHOT switch (41)
- 11** BATT (battery release) lever (27)
- 12** Tripod receptacle
Attach the tripod (optional: the length of the screw must be less than 5.5 mm (7/32 in.)) to the tripod receptacle using a tripod screw.
- 13** Remote sensor
Point the Remote Commander (p. 142) towards the remote sensor to operate your camcorder.

Remote Commander

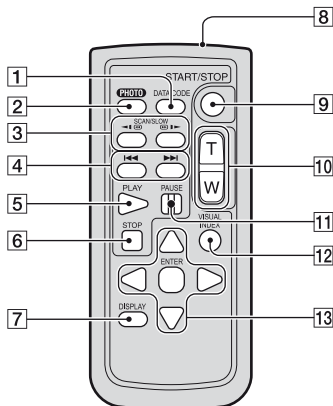

Insulation sheet

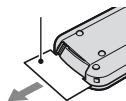

- 1** DATA CODE button (84)
Displays the date and time or camera setting data of the recorded images when you press this during playback.
- 2** PHOTO button (38)
The on-screen image when you press this button will be recorded as a still image.
- 3** SCAN/SLOW buttons (45)
- 4** ◀◀ ▶▶ (Previous/Next) buttons (45)
- 5** PLAY button (45)
- 6** STOP button (45)
- 7** DISPLAY button (27)
- 8** Transmitter
- 9** START/STOP button (p.37)
- 10** Power zoom buttons (39, 47)
- 11** PAUSE buttons (45)
- 12** VISUAL INDEX button (44)
Displays a VISUAL INDEX screen when you press this during playback.
- 13** ◀ / ▶ / ▲ / ▼ / ENTER buttons
When you press any button on the VISUAL INDEX screen or Playlist, the orange frame appears on the LCD screen. Select a desired button or an item with ◀ / ▶ / ▲ / ▼, then press ENTER to enter.

Notes

- Remove the insulation sheet before using the Remote Commander.
- Point the Remote Commander towards the remote sensor to operate your camcorder (p. 141).
- When no commands have been sent from the Remote Commander in a certain period, the orange frame disappears. When you press any of ◀ / ▶ / ▲ / ▼, or ENTER again, the frame appears at the position where it was displayed last.
- You cannot select some buttons on the LCD screen using ◀ / ▶ / ▲ / ▼.
- To change the battery, see page 134.

Indicators displayed during recording/playback

Recording movies

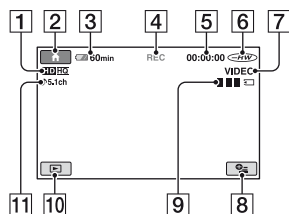

- 1 Recording format (HD/SD) (14) and recording mode (HQ+/HQ/SP/LP) (78)
- 2 HOME button (18)
- 3 Remaining battery (approx.) (27)
- 4 Recording status ([STBY] (standby) or [REC] (recording))
- 5 Counter (hour/minute/second)
- 6 Disc type (16)
- 7 Recording mode (34)
Appears for DVD-RW recorded in the SD (standard definition) image quality only.
- 8 OPTION button (19)
- 9 Dual Rec (40)
- 10 VIEW IMAGES button
- 11 5.1ch surround recording (39)

Recording still images

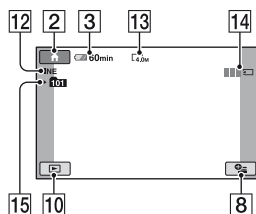

- 12 Quality ([FINE] / [STD]) (83)
- 13 Image size (81)
- 14 Appears while a still image is being saved.
- 15 Recording folder

💡 Tips

- When using the Dual Rec function, the movie and still image shooting screens are both shown together. The display position differs slightly from that during normal operation.
- As the number of still images recorded in “Memory Stick Duo” increases, new folders are automatically created to store them.

Indicators displayed during recording/playback (Continued)

Viewing movies

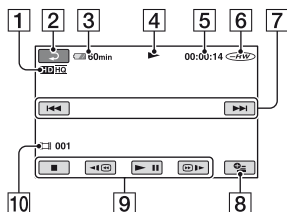

- 1 Recording format (HD/SD) (14) and recording mode (HQ+/HQ/SP/LP) (78)
- 2 Return button
- 3 Remaining battery (approx.) (27)
- 4 Playback mode
- 5 Counter (hour/minute/second)
- 6 Disc type (16)
- 7 Previous/Next button (45)
- 8 OPTION button (19)
- 9 Video operation buttons (45)
- 10 Scene number

Viewing still images

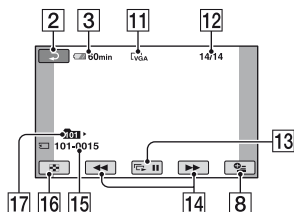

- 11 Image size (81)
- 12 Current still image number /Total number of recorded still images
- 13 Slide show button (47)
- 14 Previous/Next button (46)
- 15 Data file name
- 16 VISUAL INDEX button (44)
- 17 Playback folder

Indicators when you made changes

Following indicators appear during recording/playback to indicate the settings of your camcorder.

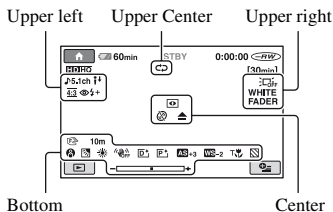

Upper left

Indicator	Meaning
	5.1ch surround recording/playback (39)
	Self-timer recording (94)
	Flash light (40)
	MICREF LEVEL low (94)

Upper center

Indicator	Meaning
	Slide show set (47)

Upper right

Indicator	Meaning
	Fader (93)
	LCD backlight off (30)

Center

Indicator	Meaning
	NightShot (41)
	Super NightShot (93)
	Color Slow Shutter (92)

Indicator	Meaning
	PictBridge connecting (63)
	Warning (118)

Bottom

Indicator	Meaning
	Picture effect (94)
	Digital effect (93)
	Manual focus (90)
0.1m, 1.0m, 10m, ∞	Focal distance (90)
	PROGRAM AE (91)
	Backlight (41)
	White balance (92)
	WIDE SELECT (79)
	SteadyShot off (79)
	SPOT METER (91)/EXPOSURE (91)
	AE SHIFT (78)
	WB SHIFT (78)
	Tele macro (90)
	Zebra (80)

Data code during recording

The date, time, and camera setting data of the recorded images are recorded automatically on the disc and “Memory Stick Duo.” They are not displayed while recording. However, you can check them as [DATA CODE] during playback (p. 84). You can view the recording date and time on another device, etc. ([SUB-T DATE], p. 80).

Glossary

■ 12cm disc

A disc with a diameter of 12cm. You cannot use 12cm discs with your camcorder.

■ 5.1ch surround sound

A system that plays back sound on 6 speakers, 3 at the front (left, right and center) and 2 at the rear (right and left) with an additional low-pass subwoofer counted as a 0.1 channel for frequencies of 120 Hz or lower.

■ 8cm disc

A disc with a diameter of 8cm. You can use 8cm discs with your camcorder.

■ AVCHD format

A high definition digital video camera format used to record an HD (high definition) signal using the MPEG-4 AVC/H.264 format.

■ Disc menu

A menu screen that enables you to select a particular scene from a disc being played back on another device.

In case of the SD (standard definition) image quality, a DVD menu is displayed.

■ Disc title

The title (name) given to a recorded disc.

■ Dolby Digital

An audio encoding (compression) system developed by Dolby Laboratories Inc.

■ Dolby Digital 5.1 Creator

Sound compression technology developed by Dolby Laboratories Inc. which compresses audio efficiently while preserving high sound quality. It enables recording of 5.1ch surround sound while using disc space more efficiently. Discs created by Dolby Digital 5.1 Creator can be played back on a device compatible with the disc created on your camcorder.

■ Double-sided disc

Disc that can be recorded on both sides.

■ DVD format

A format used to record an SD (standard definition) signal on 8cm DVD discs.

■ DVD-R

A disc that does not enable re-recording. It is mostly used for saving data that does not need to be edited. Once the disc is finalized, you cannot record onto it even if it has some free space left.

■ DVD+R DL

A disc that does not enable re-recording. DL stands for Double Layer. There are 2 recording layers on one side of a disc that enables a long recording time on a disc. Unlikely to a double-sided disc, you do not need to turn over DVD+R DL.

■ DVD-RW

A re-recordable disc. If the disc is recorded with HD (high definition) image quality, various editing functions are possible on your camcorder after recording.

If the case of SD (standard definition) image quality, you must choose a recording mode: VIDEO mode or VR mode. In the case of VR mode, various editing functions are possible on your camcorder.

■ DVD+RW

A re-recordable disc. If the disc is recorded with HD (high definition) image format, various editing is possible on your camcorder after recording.

■ Finalizing

The process of making discs recorded on your camcorder compatible for playback on other devices.

■ Formatting

The process of deleting all recorded movies from a disc and restoring its original storage capacity so that it can be rerecorded onto.

■ HOME MENU

The HOME MENU is the primary screen displayed when  (HOME) is pressed, and

works as the gateway to the functions of your camcorder.

■ JPEG

JPEG stands for Joint Photographic Experts Group, a still image data compression (data capacity reduction) standard. Your camcorder records still images in JPEG format.

■ MPEG

MPEG stands for Moving Picture Experts Group, the group of standards for the coding (image compression) of video (movie) and audio. There are MPEG1 and MPEG2 formats. Your camcorder records movies with SD (standard definition) image quality in MPEG2 format.

■ MPEG-4 AVC/H.264

The latest image coding format standardized jointly by two international standardization organizations, the ISO-IEC and the ITU-T, in 2003. Compared with the conventional MPEG2 format, MPEG-4 AVC/H.264 has more than twice the efficiency. Your camcorder employs MPEG-4 AVC/H.264 to encode high definition movies.

■ OPTION MENU

The OPTION MENU appears when  (OPTION) is pressed, and allows quick access to the functions available for your camcorder's status at that time.

■ Original

A movie recorded by your camcorder onto a disc is called an "original."

■ Pickup lens

The component that optically reads signals from a recorded disc.

■ Playlist

A list of your favorite selected original movies.

■ Recording image quality

The image quality, HD (high definition) or SD (standard definition), is selected for a disc in choices made during the formatting process. The higher the recording quality, the shorter the recording time of a disc.

■ Thumbnail

Reduced-size images which enable you to view many images at the same time. "VISUAL INDEX" and "disc menu" use a thumbnail display system.

■ Unfinalizing

The process of treating a finalized disc that has some unused recording capacity so that it can be recorded on again.

■ VBR

VBR stands for Variable Bit Rate, the recording format for automatically controlling the bit rate (the volume of recording data in a given time segment) according to the scene being recorded. For fast-moving video, a lot of disc space is used to produce a clear image, so the recording time of a disc shortens.

■ VIDEO mode

One of the recording formats you can select when using a DVD-RW with SD (standard definition) image quality. VIDEO mode provides excellent compatibility with other DVD devices.

■ VISUAL INDEX

This function displays images of movies and still images you have recorded so that you can select those scenes you want to play back.

■ VR mode

One of the recording formats you can select when using a DVD-RW with SD (standard definition) image quality. VR mode enables editing (deleting or sequence rearrangement) with your camcorder. Finalizing the disc lets you play it back on a VR mode compatible DVD device.

Index

Numeric

1080i/576i.....	86
16:9.....	34, 86
16:9 WIDE.....	79
21-pin adaptor.....	53
4:3.....	79, 86
4:3 TV.....	51
576i.....	86
5.1ch surround recording.....	39
5.1-channel surround sound	39
8 cm disc.....	16

A

AC Adaptor.....	26
ACCESS lamp.....	33
Access lamp.....	35
Active Interface Shoe.....	39
Additional recording.....	74
Adjusting exposure for back light.....	41, 109
AE SHIFT.....	78
AREA SET.....	87
Aspect ratio.....	34
AVCHD format.....	14, 127
A.SHUT OFF (Auto shut off).....	88
A/V connecting cable.....	49, 62
A/V OUT jack.....	49, 62

B

BACK LIGHT.....	41, 109
BATT (battery release) lever	27
Battery	
BATT INFO (Battery info).....	27
Remaining battery.....	27
BEACH&SKI.....	91
BEEP.....	85
BLACK FADER.....	93
Button-type lithium battery.....	134

B&W.....	94
----------	----

C

CALIBRATION.....	132
Camera control ring.....	42
CAMERA DATA.....	84
CD-ROM.....	96
Charging the battery.....	26
Battery pack.....	26
Pre-installed rechargeable battery.....	133
Charging time.....	27
CHG (charge) lamp.....	26
CLOCK SET.....	31
CLOCK/LANG.....	87
COLOR SLOW S (Color Slow Shutter).....	92, 113
COMPONENT.....	86
COMPONENT OUT jack....	49
Component video cable.....	49
Compression format.....	128
Computer.....	96
Macintosh.....	101
Windows.....	96
Connection	
4:3 TV.....	51
DVD/HDD recorders....	62
High definition TV.....	49
Printer.....	63
VCR.....	62
Wide TV.....	51
Copyright.....	5, 137

D

DATA CODE.....	31, 84
DATE/TIME.....	31, 84
DC IN jack.....	26
DC plug.....	26
DELETE	
Disc.....	54
"Memory Stick Duo"....	55

DEMO MODE.....	87, 103
DIGITAL ZOOM.....	79
Disc cover OPEN switch.....	33
DISC INFO.....	75
Disc menu.....	69
Disc remaining.....	80
DISC SELECT GUIDE.....	71
DISP OUTPUT.....	86
Display indicators.....	143
DISP/BATT INFO button.....	27, 30
DIVIDE	
Original.....	56
Playlist.....	59
Dolby Digital 5.1 Creator....	39
Double-sided disc.....	125
Dual Rec.....	40
Dubbing.....	62
DVD drive.....	70
DVD format.....	14
DVD-R.....	16
DVD-RW.....	16
DVD+R DL.....	16
DVD+RW.....	16
D.EFFECT (Digital effect).....	93, 113

E

Editing.....	54
EXPOSURE.....	91, 113
EXP.FOCUS (Expanded Focus).....	79, 113

F

FADER.....	93, 113
FILE NO. (File number).....	83
Finalize.....	66, 115
FINE.....	83
Fireworks.....	92
First Step Guide....	96, 101, 102
Flash.....	107

Flash button	40
FLASH LEVEL	83
FOCUS	90, 109
FORMAT	128
Full charge	26

G

GENERAL SET	87
Grip belt	36
GUIDEFAME	80

H

HD REC MODE	78
HD (high definition) image quality	14
HDMI cable	50
HDMI OUT jack	49
Help	
HOME MENU	22
Software	96
High Definition TV	49
High-speed transfer	97
Holding the camcorder	36
HOME MENU	18, 76
CLOCK/LANG	87
GENERAL SET	87
MOVIE SETTINGS	78
OUTPUT SETTINGS	86
PHOTO SETTINGS	81
SOUND/DISP SET	85
VIEW IMAGES SET	84
HQ	78
HQ+	78

I

Icon	See Display indicators
Image quality	14, 83
IMAGE SIZE	81
Index screen display button	144
Indicators	145
INDOOR	92

“InfoLITHIUM” battery pack	130
Infrared port	41
Install	98
Insulation sheet	142
Internal 4ch microphone	141

J

Jacks	48
JPEG	128, 147

L

LANDSCAPE	92
LANGUAGE SET	87
LCD backlight	30
LCD BL LEVEL (LCD back light level)	85, 113
LCD BRIGHT	85
LCD COLOR	85
LCD PANEL	86
LCD panel	30
LCD BL LEVEL	85
LCD BRIGHT	85
LCD COLOR	85
LCD screen	30
Lens cover	30, 36
LP	78
LUMI. KEY (luminance key)	93

M

Macintosh	101
Mains lead	26
Maintenance	131
MANAGE DISC/MEMORY category	65
“Memory Stick”	128
“Memory Stick Duo”	
Insert/Eject	35
Number of recordable pictures	82
Write-protect tab	128

Memory Stick Duo adaptor	129
“Memory Stick Duo” slot	35
MICREF LEVEL	94
Mirror mode	41
Moisture condensation	132
Movie	
Image quality	14
Recording mode	78
Shooting	37
MOVIE SETTINGS	78
MPEG	147
MPEG-4 AVC/H.264	147

N

NightShot	41
NIGHTSHOT switch	41
NS LIGHT (NightShot Light)	79
Number of recordable pictures	82

O

OLD MOVIE	93, 113
ONE PUSH	92
Operation confirmation beep	See BEEP
OPTION MENU	19, 88
Original	
DELETE	54
DIVIDE	56
OTHERS category	54
OUTDOOR	92
OUTPUT SETTINGS	86

P

PAL	123
PASTEL	94
PB zoom	47
PHOTO button	142
PHOTO SETTINGS	81
Pickup lens	133

Index (Continued)

PictBridge 63
PictBridge PRINT 63
PICT.EFFECT (Picture effect)..... 94, 113
Playback 44
Playing time 28
Playlist
 Creating 57
 DIVIDE 59
 ERASE 58
 MOVE 59
 Playback 58
PORTRAIT (Soft portrait) .. 91
POWER switch..... 29
Pre-installed rechargeable battery 133
Preparation
 Camcorder 25
 Computer 96
Print 63
PROGRAM AE 91, 112
Protect 122

Q

QUALITY 83

R

REC LAMP (Recording lamp)..... 87
Recording format..... 14
Recording image quality 14
Recording time 27
REDEYE REDUC 83
REMAINING 80
Remaining battery 143, 144
Remote Commander ... 110, 142
REMOTE CTRL (Remote control) 88
RESET 140
RING SETTING 80

S

S VIDEO cable 52
S VIDEO jack 62
SD REC MODE 78
SD (standard definition) image quality 14
SELECT DEVICES category 61
Self-diagnosis display 118
SELF-TIMER 94
SEPIA 94
Setting the date and time 31
SETTINGS category 76
Shooting 36
Shoulder belt 138
SMTH SLW REC 42
Software 98
SOUND/DISP SET 85
SP 78
Speaker 140
Specifications 134
SPOT FOCUS 90, 113
SPOT METER (Flexible spot meter) 91, 112
SPOTLIGHT 91
STANDARD 83
STEADYSHOT ... 79, 109, 113
Still image
 IMAGE SIZE 81
 QUALITY 83
 Shooting 38
 Still image format 128
SUB-T DATE 80
SUNSET&MOON 91
SUPER NS (Super NightShot)..... 93, 113
System requirements ... 96, 101

T

TELE MACRO 90, 113
Telephoto 39

Thumbnail 147
Touch panel 20
Trademark 137
Transmitter 142
Tripod 141
TV color system 123
TV CONNECT Guide 48
TV TYPE 86

U

Unfinalizing 74, 115
USB 2.0 97
USB cable 25
Using abroad 123

V

VF B.LIGHT (Viewfinder brightness) 85
VIDEO mode 34
VIEW IMAGES SET 84
Viewfinder 31
 Brightness 85
Viewfinder lens adjustment lever 31
Viewing pictures on a TV ... 48
VISUAL INDEX 44
VOLUME 84
Volume adjustment 45
V-OUT/PANEL 86
VR mode 34

W

Wall socket 26
Warning indicators 118
Warning messages 119
WB SHIFT (White Balance Shift) 78
WHITE BAL. (White balance) 92, 113
WHITE FADER 93
Wide angle 39
WIDE SELECT 79, 113

Wide TV	51
Windows	96, 101
World time difference.....	124
Write-protect tab	128

Z

ZEBRA	80
Zoom.....	39
Zoom lever.....	39