

# SONY®

3-075-896-12(1)

## Digital Still Camera

### Operating Instructions

Before operating the unit, please read this manual thoroughly, and retain it for future reference.

### Owner's Record

The model and serial numbers are located on the bottom. Record the serial number in the space provided below. Refer to these numbers whenever you call upon your Sony dealer regarding this product.

Model No. DSC-P7/P9

Serial No. \_\_\_\_\_

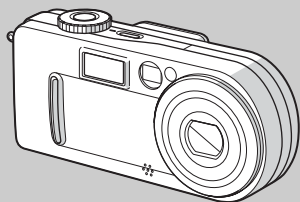

## DSC-P7/P9

**Cyber-shot**  
Digital Still Camera



MEMORY STICK™



Getting started \_\_\_\_\_

Shooting still images \_\_\_\_\_

Viewing still images \_\_\_\_\_

Deleting still images \_\_\_\_\_

Copying still images to your computer \_\_\_\_\_

Before advanced operations \_\_\_\_\_

Advanced still image shooting \_\_\_\_\_

Advanced still image viewing \_\_\_\_\_

Still image editing \_\_\_\_\_

Enjoying movies \_\_\_\_\_

Troubleshooting \_\_\_\_\_

Additional information \_\_\_\_\_

Index

## WARNING

To prevent fire or shock hazard, do not expose the unit to rain or moisture.

## For the Customers in the U.S.A.

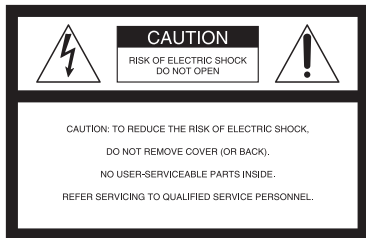

This symbol is intended to alert the user to the presence of uninsulated “dangerous voltage” within the product’s enclosure that may be of sufficient magnitude to constitute a risk of electric shock to persons.



This symbol is intended to alert the user to the presence of important operating and maintenance (servicing) instructions in the literature accompanying the appliance.

Never expose the battery pack to temperature above 60°C (140°F), such as in a car parked in the sun or under direct sunlight.

If you have any questions about this product, you may call:

Sony Customer Information Services Center  
1-800-222-SONY (7669)

The number below is for the FCC related matters only.

### Regulatory Information

#### Declaration of Conformity

Trade Name: SONY  
Model No.: DSC-P9  
Responsible Party: Sony Electronics Inc.  
Address: 680 Kinderkamack  
Road, Oradell, NJ  
07649 USA  
Telephone No.: 201-930-6972

This device complies with Part 15 of the FCC Rules. Operation is subject to the following two conditions: (1) This device may not cause harmful interference, and (2) this device must accept any interference received, including interference that may cause undesired operation.

#### Declaration of Conformity

Trade Name: SONY  
Model No.: DSC-P9  
Responsible Party: Sony Electronics Inc.  
Address: 680 Kinderkamack  
Road, Oradell, NJ  
07649 USA  
Telephone No.: 201-930-6972

This device complies with Part 15 of the FCC Rules. Operation is subject to the following two conditions: (1) This device may not cause harmful interference, and (2) this device must accept any interference received, including interference that may cause undesired operation.

#### CAUTION

You are cautioned that any changes or modifications not expressly approved in this manual could void your authority to operate this equipment.

**Note:**

This equipment has been tested and found to comply with the limits for a Class B digital device, pursuant to Part 15 of the FCC Rules. These limits are designed to provide reasonable protection against harmful interference in a residential installation. This equipment generates, uses, and can radiate radio frequency energy and, if not installed and used in accordance with the instructions, may cause harmful interference to radio communications. However, there is no guarantee that interference will not occur in a particular installation. If this equipment does cause harmful interference to radio or television reception, which can be determined by turning the equipment off and on, the user is encouraged to try to correct the interference by one or more of the following measures:

- Reorient or relocate the receiving antenna.
- Increase the separation between the equipment and receiver.
- Connect the equipment into an outlet on a circuit different from that to which the receiver is connected.
- Consult the dealer or an experienced radio/TV technician for help.

The supplied interface cable must be used with the equipment in order to comply with the limits for a digital device pursuant to Subpart B of Part 15 of FCC Rules.

**For the Customers in the U.S.A. and Canada****RECYCLING LITHIUM-ION BATTERIES**

Lithium-Ion batteries are recyclable.

You can help preserve our environment by returning your used rechargeable batteries to the collection and recycling location nearest you.



For more information regarding recycling of rechargeable batteries, call toll free 1-800-822-8837, or visit <http://www.rbc.org/>

**Caution:** Do not handle damaged or leaking Lithium-Ion batteries.

**CAUTION**

TO PREVENT ELECTRIC SHOCK, DO NOT USE THIS POLARIZED AC PLUG WITH AN EXTENSION CORD, RECEPTACLE OR OTHER OUTLET UNLESS THE BLADES CAN BE FULLY INSERTED TO PREVENT BLADE EXPOSURE.

**Notice on the supplied AC power adaptor for the customers in the United Kingdom**

A moulded plug complying with BS 1363 is fitted to this equipment for your safety and convenience.

Should the fuse in the plug supplied need to be replaced, a 5 AMP fuse approved by ASTA or BSI to BS 1362, (i.e., marked with ⚡ or ⚡ mark) must be used.

If the plug supplied with this equipment has a detachable fuse cover, be sure to attach the fuse cover after you change the fuse. Never use the plug without the fuse cover. If you should lose the fuse cover, please contact your nearest Sony service station.

**For the Customers in Germany**

Directive: EMC Directive 89/336/EEC, 92/31/EEC

This equipment complies with the EMC regulations when used under the following circumstances:

- Residential area
- Business district
- Light-industry district

(This equipment complies with the EMC standard regulations EN55022 Class B.)

## Attention for the Customers in Europe

This product has been tested and found compliant with the limits sets out on the EMC Directive for using connection cables shorter than 3 meters.

The electromagnetic fields at the specific frequencies may influence the picture and sound of this digital camera.

### Notice

If static electricity or electromagnetism causes data transfer to discontinue midway (fail), restart the application or disconnect and connect the USB cable again.

## “Memory Stick” and battery pack





## For the Customers in the U.S.A. and Canada

THIS DEVICE COMPLIES WITH PART 15 OF THE FCC RULES. OPERATION IS SUBJECT TO THE FOLLOWING TWO CONDITIONS:

- (1) THIS DEVICE MAY NOT CAUSE HARMFUL INTERFERENCE, AND
  - (2) THIS DEVICE MUST ACCEPT ANY INTERFERENCE RECEIVED, INCLUDING INTERFERENCE THAT MAY CAUSE UNDESIRE OPERATION.
- THIS CLASS B DIGITAL APPARATUS COMPLIES WITH CANADIAN ICES-003.

## Trademarks

- “Memory Stick,”  “MagicGate Memory Stick,” and  are trademarks of Sony Corporation.
- “MagicGate” and **MAGICGATE** are trademarks of Sony Corporation.
- “InfoLITHIUM” is a trademark of Sony Corporation.
- Microsoft and Windows are registered trademarks of the U.S. Microsoft Corporation in the United States and other countries.
- Macintosh, Mac OS, and QuickTime, are trademarks or registered trademarks of Apple Computer, Inc.
- In addition, system and product names used in this manual are, in general, trademarks or registered trademarks of their respective developers or manufacturers. However, the <sup>TM</sup> or ® marks are not used in all cases in this manual.

# Before using your camera

## **Trial recording**

Before you record one-time events, you may want to make a trial recording to make sure that the camera is working correctly.

## **No compensation for contents of the recording**

Contents of the recording cannot be compensated for if recording or playback is not possible due to a malfunction of your camera or recording medium, etc.

## **Notes on image data compatibility**

- This camera conforms with the Design rule for Camera File system universal standard established by the JEITA (Japan Electronics and Information Technology Industries Association).
- Playback of images recorded with your camera on other equipment and playback of images recorded or edited with other equipment on your camera are not guaranteed.

## **Precaution on copyright**

Television programs, films, video tapes, and other materials may be copyrighted. Unauthorized recording of such materials may be contrary to the provision of the copyright laws.

## **Do not shake or strike the camera**

In addition to malfunctions and inability to record images, this may render the “Memory Stick” unusable or image data breakdown, damage or loss may occur.

## **LCD screen, LCD finder (only models with a LCD finder) and lens**

- The LCD screen and the LCD finder are manufactured using extremely high-precision technology so over 99.99% of the pixels are operational for effective use. However, there may be some tiny black points and/or bright points (white, red, blue or green in color) that constantly appear on the LCD screen and the LCD finder. These points are normal in the manufacturing process and do not affect the recording in any way.
- Be careful when placing the camera near a window or outdoors. Exposing the LCD screen, the finder or the lens to direct sunlight for long periods may cause malfunctions.

## **Do not get the camera wet**

When taking pictures outdoors in the rain or under similar conditions, be careful not to get the camera wet. If moisture condensation occurs, see page 95 and follow the instructions on how to remove it before using the camera.

## **The power zoom lens**

This camera is equipped with a power zoom lens. Be careful not to bump the lens, and be careful not to apply force to it.

## **The pictures used in this manual**

The photographs used as examples of pictures in this manual are reproduced images, and are not actual images shot using this camera.

## **Do not aim the camera at the sun or other bright light**

This may cause irrecoverable damage to your eyes.

## **Back up recommendation**

To avoid the potential risk of data loss, always copy (back up) data to a disk.

# Table of contents

Before using your camera.....	5
Identifying the parts.....	8

## Getting started

Charging the battery pack.....	10
Using an external power source.....	14
Using your camera abroad.....	14
Turning on/off your camera.....	15
How to use the control button.....	15
Setting the date and time.....	16

## Shooting still images

Inserting and removing a “Memory Stick” .....	18
Deciding the still image size and quality	19
Basic still image shooting (using auto adjustment mode) .....	22
Checking the last image shot (Quick Review) .....	23
Using the zoom feature.....	24
Shooting close-ups (Macro).....	24
Using the self-timer .....	25
Selecting a flash mode.....	26
Shooting with the finder .....	28
Shooting with the date and time inserted .....	29
Shooting according to scene conditions (Scene selection).....	30

## Viewing still images

Viewing images on the LCD screen of your camera .....	32
Viewing single images .....	32
Viewing Index (nine or three images display).....	33
Viewing images on a TV screen.....	34

## Deleting still images

Deleting images .....	36
Deleting on the Index (nine images) screen .....	37
Deleting on the Index (three images) screen .....	38
Formatting a “Memory Stick” .....	40

## Copying still images to your computer

Copying still images to your computer ..	41
❶ Installing the USB driver .....	42
❷ Preparing your camera .....	43
❸ Connecting your camera to your computer .....	44
❹ Copying images.....	45
❺ Viewing the images on your computer .....	48
For Macintosh users .....	51

## Before advanced operations

How to setup and operate your camera...52	
Changing menu settings.....52	
Changing items in the SET UP screen .....	52

## Advanced still image shooting

Choosing a focus method.....53	
Shooting with the AF lock using Center AF.....	54
Setting the distance to the subject (Focus preset) .....	55
Adjusting the exposure (EV adjustment).....	55
Spot light-metering .....	56
Adjusting color tones (White Balance)...57	
Shooting multiple frames (Clip Motion).....	58
Shooting in Multi Burst mode (Multi Burst).....	59
Shooting still images for e-mail (E-MAIL) .....	61
Shooting still images with audio files (VOICE) .....	61
Adding special effects (Picture Effect) ...62	

## Advanced still image viewing

Enlarging a portion of a still image.....	63
Enlarging an image	
– Playback zoom.....	63
Recording an enlarged image	
– Trimming.....	64
Playing back successive images (Slide show).....	64
Rotating still images.....	65

## Still image editing

Protecting images (Protect).....	66
For the single screen .....	66
For the Index (nine images) screen....	66
For the Index (three images) screen....	67
Changing image size (Resize).....	68
Choosing images to print (Print mark)....	69
For the single screen .....	69
For the Index (nine images) screen....	69
For the Index (three images) screen....	70

## Enjoying movies

Shooting movies.....	71
Viewing movies on the LCD screen .....	72
Deleting movies .....	73
For the single screen .....	73
For the Index (nine images) screen....	73
For the Index (three images) screen....	74

Editing movies.....	75
Cutting movies.....	75
Deleting unnecessary portions of movies .....	76
Copying movies to your computer .....	77
For Windows 98, 98SE, 2000, Me users.....	77
For Windows XP users.....	77
For Macintosh users .....	78

## Troubleshooting

Troubleshooting.....	79
Warnings and messages.....	86
Self-diagnostics display.....	87

## Additional information

The number of images that can be saved/ shooting time.....	88
Menu items .....	89
SET UP items .....	93
Precautions.....	95
The “Memory Stick”.....	96
The “InfoLITHIUM” battery pack .....	96
Specifications.....	97
The LCD screen .....	99
Index .....	102

## Identifying the parts

Attaching the strap

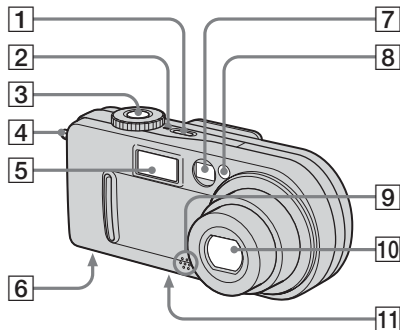
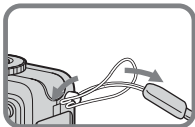

- 1 POWER button** (15)
- 2 POWER lamp** (15)
- 3 Shutter button** (22)
- 4 Wrist strap hook**
- 5 Flash** (26)
- 6 Speaker (bottom surface)**
- 7 Finder window**
- 8 Self-timer lamp** (26)/  
**AF illuminator** (27, 93)
- 9 Microphone**
- 10 Lens**
- 11 Tripod receptacle (bottom surface)**

- Use a tripod with a screw length of less than 5.5 mm (7/32 inch). You will be unable to firmly secure the camera to tripods having longer screws, and may damage the camera.
- Do not touch the microphone while recording.



- 14 Jack cover
- 15 A/V OUT (MONO) jack (34)

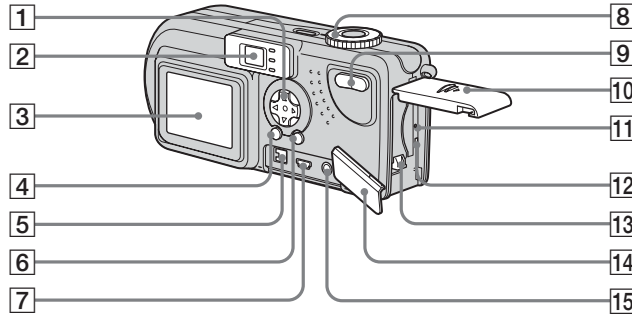

- 1 **Control button**  
(Menu on) (▲/▼/◀/▶/●) (15)/  
(Menu off) (⚡/🔋/📷/🌸) (26/25/23/  
24)
- 2 **Finder** (28)  
  
Self-timer/recording  
lamp (red)  
AE/AF lock lamp  
(green)  
⚡/CHG lamp (orange)  
(11, 26)
- 3 **LCD screen**
- 4 **DSPL/LCD ON/OFF button** (28)
- 5 **DC IN jack** (10, 14)
- 6 **MENU button** (19)

- 7 **USB jack** (44)
- 8 **Mode dial** (16)  
**SCN:** To shoot in the Scene  
selection mode  
**📷:** To shoot still images  
**▶:** To view or edit images  
**🎞:** To shoot movies /Clip Motion  
images/Multi Burst mode images  
**SET UP:** To set the SET UP items
- 9 **Zoom button (for shooting)** (24)/  
**Index button (for viewing)** (33)
- 10 **Battery/"Memory Stick" cover**
- 11 **RESET button** (79)
- 12 **Access lamp** (18)
- 13 **Battery eject lever** (11)

## Charging the battery pack

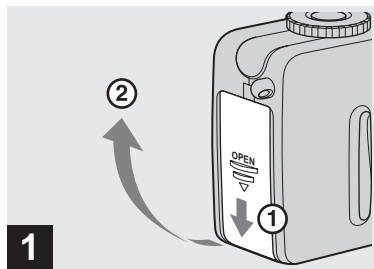

**1** → Open the battery/"Memory Stick" cover.

Slide the cover in the direction of the arrow.

- When charging the battery pack, make sure the camera is not turned on (page 15).
- The camera operates only with the "InfoLITHIUM" battery NP-FC10 battery pack (C type) (supplied). You cannot use any other battery pack (page 96).

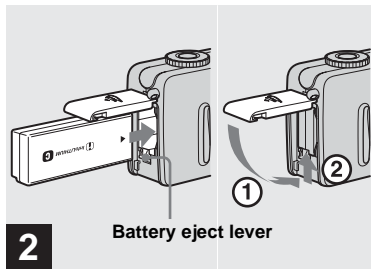

**2** → Insert the battery pack, and close the cover.

Insert the battery pack with the ▲ mark facing toward the battery compartment as illustrated above. Make sure the battery pack is properly inserted, then close the cover.

- While pushing the battery eject lever down using the front edge of the battery pack, you can easily insert the battery pack.

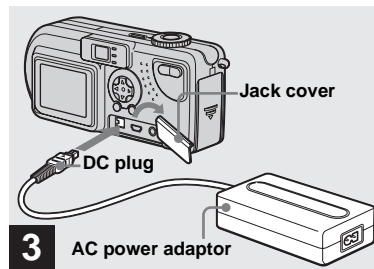

**3** → Open the jack cover, and connect the AC-LS1A AC power adaptor (supplied) to the DC IN jack of the camera.

Open the cover in the arrow direction as illustrated above. Connect the plug with the ▲ mark facing up.

- Do not short the DC plug on the AC power adaptor with a piece of metal. This may cause a malfunction.
- Clean the DC plug of the AC power adaptor with a dry cotton bud. Do not use the dirty plug. Use of the dirty plug may not properly charge the battery pack.

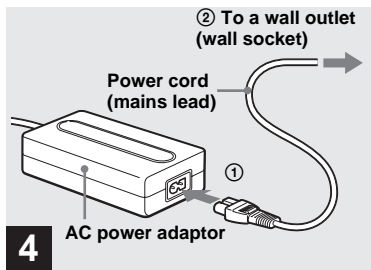

- ➔ **Connect the power cord (mains lead) to the AC power adaptor and to a wall outlet (wall socket).**

Charging starts, and the ⚡/CHG lamp lights.

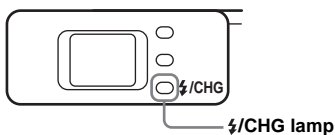

When the ⚡/CHG lamp goes out, charging is finished (full charge).

- When charging is finished, disconnect the AC power adaptor both from the camera and the wall outlet (wall socket).

### To remove the battery pack

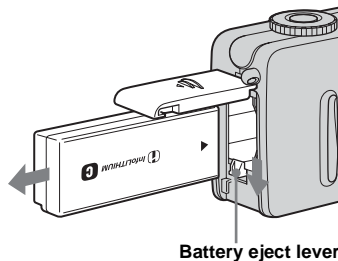

Open the battery/"Memory Stick" cover, and push down the battery eject lever in the arrow direction as illustrated above.

- Make sure you do not drop the battery pack when you remove it.

### Battery remaining indicator

The battery remaining indicator shows the remaining shooting or viewing time.

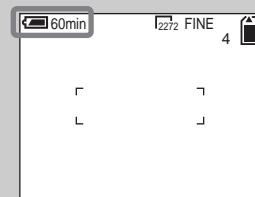

- It takes about one minute that the proper remaining time is calculated when you turn the LCD screen off and on.
- A proper remaining time may not be indicated depending on conditions of use or circumstances.

## Charging time

This represents the time required to charge fully depleted battery pack using the supplied AC-LS1A AC power adaptor in an environment where the ambient temperature is 25°C (77°F).

Battery pack	Full charge (min.)
NP-FC10 (supplied)	Approx.150

## Battery life and the number of images that can be recorded/ viewed

The tables show approximate guidelines for the length of time the camera can be used when you shoot in Normal mode in an environment where the ambient temperature is 25°C (77°F), and the supplied battery pack is fully charged. The guidelines for the number of images that can be recorded or viewed allow for changing the supplied “Memory Stick” as necessary. Actual results may differ slightly from these, depending on the conditions of use.

## Shooting still images

Under the average conditions \*1)

	Image size	NP-FC10 (supplied)	
		No. of images	Battery life (min.)
DSC-P9	2272×1704	Approx. 120	Approx. 60
DSC-P7	2048×1536	Approx. 120	Approx. 60

\*1) Shooting under the following conditions:

- The LCD screen is set to ON.
- The image quality is set to [FINE].
- Shooting one image every 30 seconds.
- Alternatively pressing the zoom W and T buttons fully for each shot.
- Using the flash once in every two shots.
- Turning on and off once in every ten shots.

## Shooting \*2) continuously

	Image size	LCD screen	NP-FC10 (supplied)	
			No. of images	Battery life (min.)
DSC-P9	2272×1704 640×480	ON	Approx. 1400	Approx. 70
		OFF	Approx. 1800	Approx. 90
DSC-P7	2048×1536 640×480	ON	Approx. 1400	Approx. 70
		OFF	Approx. 1800	Approx. 90

\*2) Shooting under the following conditions:

- The image quality is set to [STANDARD].
- Flash mode is set to “” (no flash).
- Shooting continuously every three seconds.

### Viewing<sup>\*3)</sup> still images

	Image size	NP-FC10 (supplied)	
		No. of images	Battery life (min.)
DSC-P9	2272×1704 640×480	Approx. 3200	Approx. 160
DSC-P7	2048×1536 640×480	Approx. 3200	Approx. 160

<sup>\*3)</sup>With the LCD screen on, viewing single images in order, one approximately every three seconds

### Shooting<sup>\*4)</sup> movies

	LCD screen	NP-FC10 (supplied)	
		Battery life (min.)	
DSC-P9	ON	Approx. 80	
	OFF	Approx. 110	
DSC-P7	ON	Approx. 80	
	OFF	Approx. 110	

<sup>\*4)</sup>Continuous shooting with an image size of 160×112



- The battery life and the number of images recordable are decreased under the following conditions:
  - At low temperatures.
  - Using the flash.
  - Turning on and off frequently.
  - Using the zoom frequently.
  - When [POWER SAVE] is set to [OFF].
  - When [LCD BACKLIGHT] is set to [BRIGHT].
  - Using the battery pack used repeatedly or self-discharged after charging (page 97).

### The POWER SAVE function

When the POWER SAVE function is activated, you can shoot for a longer period of time.

Set the mode dial to SET UP, and set [POWER SAVE] in [SETUP 2] to [ON]. The factory setting is [ON] (page 94).

### When the POWER SAVE function is activated

- The LCD screen will be darker than it is when [POWER SAVE] is set to [OFF]. You cannot change the settings for [LCD BACKLIGHT] at this time (page 94).
- When the power turns on, the Flash mode is normally set to “” (No flash).
- If you want to shoot using the flash, press  (Forced flash) or Auto (page 26).
- When shooting still images, the focus only works while the shutter button is pressed down halfway.

## Using an external power source

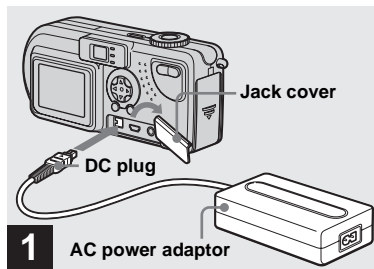

- ➔ **Open the jack cover, and connect the AC-LS1A AC power adaptor (supplied) to the DC IN jack of the camera.**

Connect the plug with the ▲ mark facing up.

- Connect the AC power adaptor to an easily accessible wall outlet (wall socket) close by. If something goes wrong while you are using the adaptor, immediately shut off the power by pulling the plug out of the wall outlet.

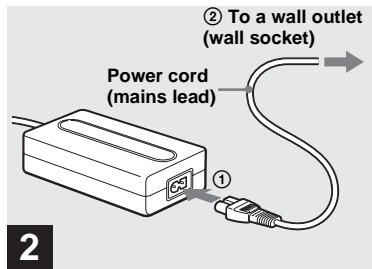

- ➔ **Connect the power cord (mains lead) to the AC power adaptor and to a wall outlet (wall socket).**

- When you have finished using the AC power adaptor, disconnect it from the DC IN jack of the camera.
- The set is not disconnected from the AC power source as long as it is connected to the wall outlet (wall socket) even if the set itself has been turned off.

## Using your camera abroad

### Power sources

You can use your camera in any country or area with the supplied AC power adaptor within 100 V to 240 V AC, 50/60 Hz. Use a commercially available AC plug adaptor [a], if necessary, depending on the design of the wall outlet (wall socket) [b].

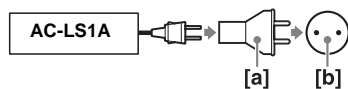

- Do not use an electrical transformer. Using this may cause a malfunction.

## Turning on/off your camera

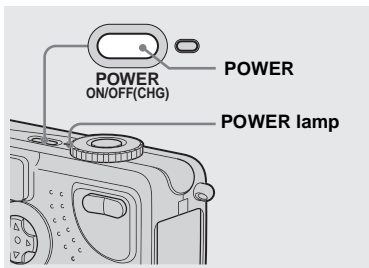



### ➔ Press **POWER** to turn on the power.

The POWER lamp lights in green, the power is on. When you turn on your camera for the first time, the CLOCK SET screen appears (see the next page).

### To turn off the power

Press POWER again, the POWER lamp goes out, and the camera turns off.

- If you turn the power on when the mode dial is set to SCN, , or  the lens comes out. Please be careful not to touch the lens portion.

## The Auto Power Off function

If no tasks are performed for a while\* when shooting, viewing images, or setting up the camera while using the battery pack, power is automatically shut off to preserve battery power. However, in the following circumstances, even if the battery pack is being used to power the camera, the Auto Power Off function will not work.





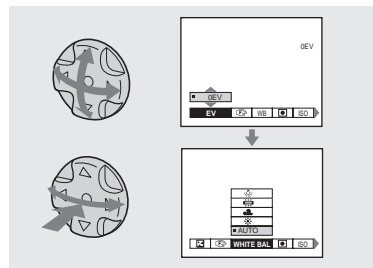

- Movies are being played back
- A slide show is being played back
- A cable is connected to the USB jack or the A/V OUT (MONO) jack

\* When [POWER SAVE] is set to [ON]:  
approximately 90 seconds  
When [POWER SAVE] is set to [OFF]:  
approximately three minutes

## How to use the control button





To change the current settings of the camera, bring up the menu or the SET UP screen (page 52), and use the control button to make the changes.

For each item, press /// to select the desired setting item, then press the center  or / to make the setting.

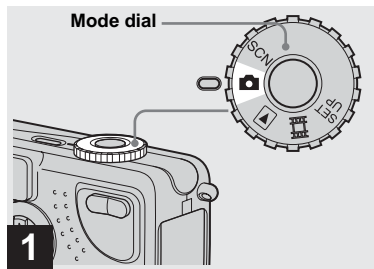
## Setting the date and time



➔ Set the mode dial to .

- You can also carry out this operation when the mode dial is set to SCN, , or .
- To change values for the time and the date that have been previously set, set the mode dial to SET UP, select [CLOCK SET] in [SETUP 1] (page 93), then proceed from Step **3**.

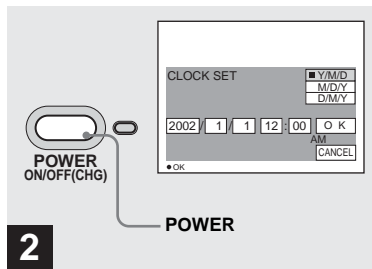

➔ Press **POWER**.

The POWER lamp lights in green and the CLOCK SET screen appears.

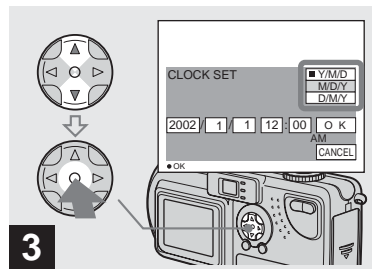

➔ Select the desired order for the date, the month and the year using **▲/▼** on the control button, then press the center **●**.

You can select from [Y/M/D] (year/month/day), [M/D/Y], and [D/M/Y].

- If the rechargeable button battery, which provides the power for saving the time data, ever loses its charge (page 95), the CLOCK SET screen automatically reappears. If this happens, reset the date and time by following the above procedure, starting from Step **3**.



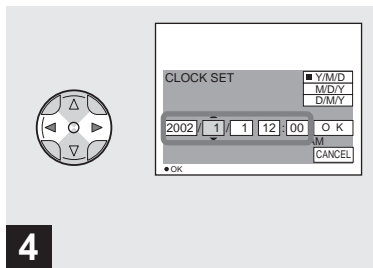

- 4** → Select the year, month, day, hour, or minute item you want to set using ◀/▶.

A ▲ will be shown above, and a ▼ will be shown below the item currently selected to be set.

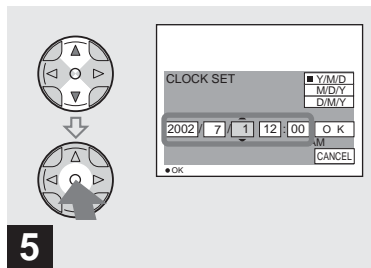

- 5** → Set the desired numerical value using ▲/▼ on the control button, then press the center ●.

After setting the current numerical value, set the next item. Repeat the above process until all of the items have been set.

- If you select [D/M/Y] in Step **3**, use the 24-hour clock display.

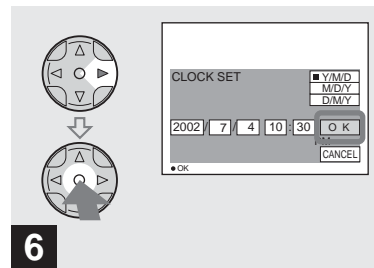

- 6** → Select [OK] using the ▶ on the control button, then press the center ●.

After the date and time are set, the clock will start to keep time.

- To cancel the setting process, select [CANCEL], then press the center ●.



## Inserting and removing a "Memory Stick"

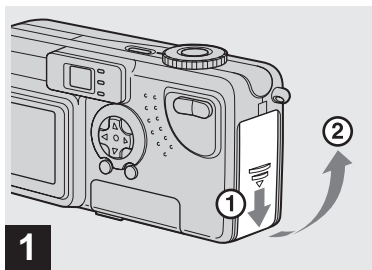

➔ **Open the battery/"Memory Stick" cover.**

Slide the cover in the direction of the arrow.

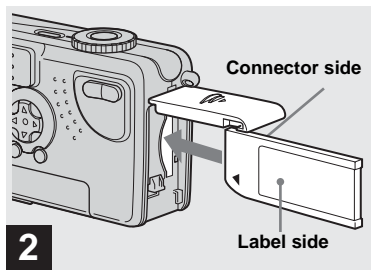

➔ **Insert the "Memory Stick."**

Insert the "Memory Stick" all the way in until it clicks as shown in the illustration.

- Whenever you insert a "Memory Stick," push it all the way in until it clicks. If you do not insert it correctly, a proper recording or playback may not be carried out.

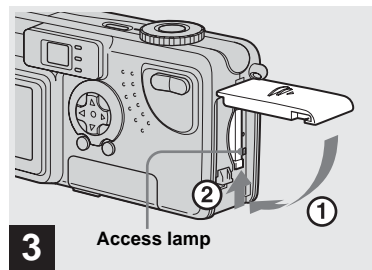

➔ **Close the battery/"Memory Stick" cover.**

**To remove the "Memory Stick"**

Open the battery/"Memory Stick" cover, then push the "Memory Stick" to pop it out.

- Whenever the Access lamp is lit, the camera is recording or reading out an image. Never remove the "Memory Stick" or turn off the power at this time.

# Deciding the still image size and quality

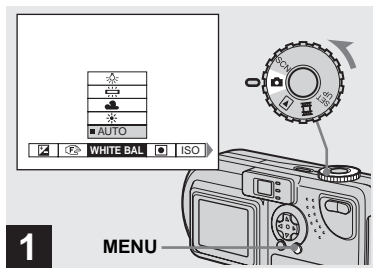

1

➔ Set the mode dial to , turn on the power, and then press MENU.

The menu appears.

- You can also carry out this operation when the mode dial is set to SCN.

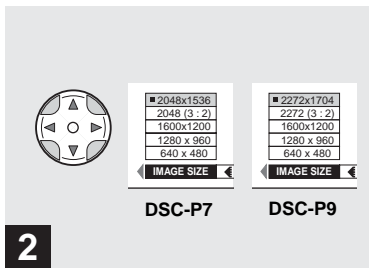



2

➔ Select  (IMAGE SIZE) using /▶ on the control button. Select the desired image size using ▲/▼.

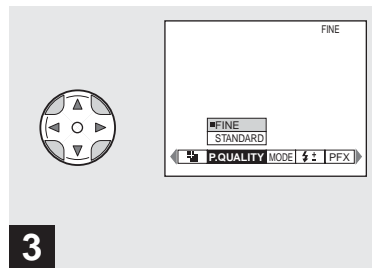
The image size is set.



3

➔ Select  (P. QUALITY) using /▶ on the control button. Select the desired image quality using ▲/▼.

The image quality is set.

When the setting is completed, press MENU. The menu disappears from the screen.

- For image quality, you can choose either [FINE] or [STANDARD].
- The image size and quality values chosen here will be preserved even when the camera is turned off.

## Image size and quality

You can choose image size (number of pixels) and image quality (compression ratio) based on the kind of images you want to shoot. The larger you make the image size and the higher you make the image quality, the better your image, but also the larger the amount of data needed to preserve your image. This means you can save fewer images in your “Memory Stick.”

Choose an image size and quality level appropriate for the kind of images you want to shoot.

You can resize the images later (Resize function, see page 68).

You can choose image size from among the five options in the following tables.

Image size	Examples
2272×1704 (DSC-P9)	Very fine prints
2272 (3:2) (DSC-P9)	3:2 prints*
2048×1536 (DSC-P7)	Very fine prints
2048 (3:2) (DSC-P7)	3:2 prints*
1600×1200	Printing A4 size images
1280×960	Printing postcard size images
640×480	For images to be attached to e-mail

\* This option records images in a horizontal to vertical proportion of 3:2 to match the size of the print paper used.

## The number of images\*\* that can be saved in a “Memory Stick”

The number of images that can be saved in FINE (STANDARD) mode are shown below.  
(Units: number of images)

Capacity Image size	8MB	16MB	32MB	64MB	128MB
2272×1704 (DSC-P9)	4 (7)	8 (14)	16 (30)	32 (60)	65 (121)
2272 (3:2) (DSC-P9)	4 (7)	8 (14)	16 (30)	32 (60)	65 (121)
2048×1536 (DSC-P7)	5 (9)	10 (18)	20 (36)	40 (74)	82 (148)
2048 (3:2) (DSC-P7)	5 (9)	10 (18)	20 (36)	40 (74)	82 (148)
1600×1200	8 (15)	16 (30)	32 (60)	64 (120)	133 (246)
1280×960	12 (23)	24 (44)	50 (93)	100 (186)	202 (375)
640×480	48 (120)	96 (240)	195 (488)	393 (983)	789 (1973)

\*\* When [REC MODE] is set to [NORMAL]  
For the number of images that can be saved in  
other modes, see page 88.

- The image size is the screen size used when viewing the images on a computer. When the images are viewed on the LCD screen of the camera, they all look the same size.
- Number of shooting images can differ from these values according to shooting conditions.
- The image size value (e.g., 1600×1200) is the number of pixels displayed.

# Basic still image shooting (using auto adjustment mode)

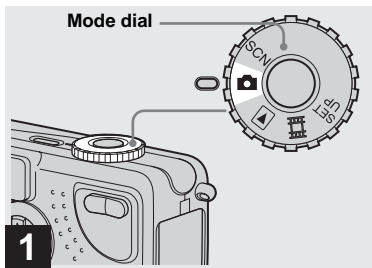

➔ Set the mode dial to , and turn on your camera.

- The lens cover opens when the power is turned on.
- Do not touch the lens portion while it is operating, such as when you press POWER to turn on the power or when the zoom function is working (page 24).
- When the mode dial is set to , the exposure and focus are adjusted automatically.

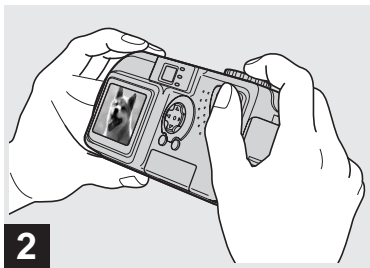

➔ Hold your camera with your both hands and position a subject in the center of the frame to focus on.

Do not cover the lens or flash with your fingers.

- You can choose either Multipoint AF mode or Center AF as the AF mode (page 53).



➔ Press and hold the shutter button halfway down.

The camera beeps. When the AE/AF lock indicator stops flashing and remains on, the camera is ready for shooting.

- If you release your finger from the shutter button, shooting will be canceled.
- The minimum focal distance to a subject is 50 cm (19 <sup>11</sup>/<sub>16</sub> inches) when the zoom is set all the way to the W side and 60 cm (23 <sup>5</sup>/<sub>8</sub> inches) when the zoom is set all the way to the T side. To shoot subjects at distances closer than this, use the Macro mode (page 24).
- The frame appearing on the LCD screen shows the limits of the area where the focus will be adjusted. (For more details on the AF range finder, see page 53.)

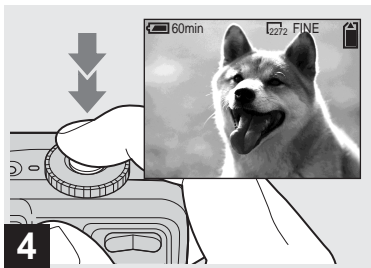

**4**

➔ **Press the shutter button fully down.**

The shutter clicks, the shooting is completed, and the still image is saved in the “Memory Stick.” When the Recording lamp goes out, you can shoot the next image.

- When you are shooting with the battery pack, if no tasks are performed for a while with the camera turned on, power is automatically shut off to preserve battery power (page 15).

## About Auto Focus

When you try to shoot a subject that is hard to focus on, the AE/AF lock indicator will change to flashing slowly.

The Auto Focus function may be difficult to use with in the following subjects. In such cases, release the shutter button, then try to recompose the shot and focus again.

- The subject is distant from the camera and dark
- The contrast of the subject and its background is poor
- The subject is seen through glass, such as a window
- A fast-moving subject
- The subject has a reflection, such as that from a mirror, or there is a luminous body and a lustrous subject
- A flashing subject.

## Checking the last image shot (Quick Review)

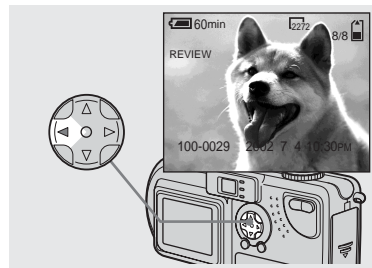

➔ **Press ◀ (Ⓢ) on the control button.**

To return to shooting mode, press the shutter button lightly or press ◀ (Ⓢ) on the control button again.

**To delete the image displayed on the LCD screen**

- 1 Press MENU to display the menu.
- 2 Press ▶ on the control button to select [DELETE], then press the center ●.
- 3 Press ▲ on the control button to select [OK], then press the center ●.  
The image will be deleted.

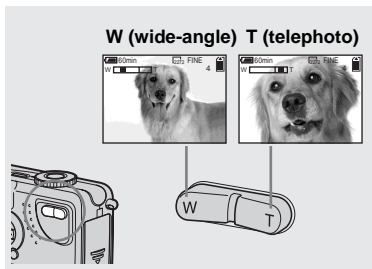

➔ Press the zoom button to choose the desired zoom position, and shoot your image.

### The minimum distance needed to focus on a subject

**When the zoom is set all the way to the W side:** approximately 50 cm (19 <sup>11</sup>/<sub>16</sub> inches) from the end of the lens

**When the zoom is set all the way to the T side:** approximately 60 cm (23 <sup>5</sup>/<sub>8</sub> inches) from the end of the lens

- The lens portion moves when the zoom feature is being used. Be very careful not to touch the lens portion.
- The zoom feature cannot be used while shooting movies (page 80).

## Digital zoom

When the zoom exceeds 3×, enlargement is carried out using digital processing of the image. The image can then be enlarged up to 6× using the digital zoom feature. When the digital zoom feature is used, image quality deteriorates. When this feature is not needed, set [DIGITAL ZOOM] to [OFF] in the SET UP settings (page 93).

The T side of this line shows the extent of digital zoom

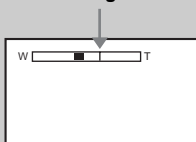

- When you are using digital zoom, you cannot confirm the image using the finder.
- When you are using the digital zoom feature, the auto focus frame is not displayed.



For close-ups of small subjects like flowers or insects, shoot using the Macro feature. You can use this feature for close-ups of subjects up to the distances specified below.



**When the zoom is set all the way to the W side:** approximately 10 cm (3 <sup>15</sup>/<sub>16</sub> inches) from the end of the lens

**When the zoom is set all the way to the T side:** approximately 60 cm (23 <sup>5</sup>/<sub>8</sub> inches) from the end of the lens

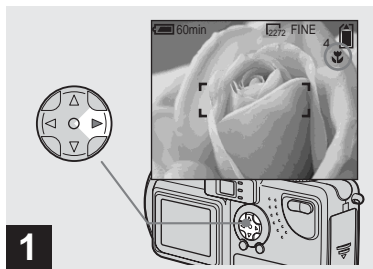



**1**

➔ Set the mode dial to , and press  (  ) on the control button.

 (Macro) will appear on the LCD screen.

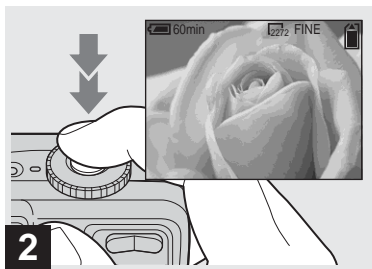

- If the menu is currently displayed, press MENU first to make the menu disappear.
- You can carry out this operation even when the mode dial is set to SCN (other than the Landscape mode) (page 30) or .



**2**

➔ Center the subject in the frame, and shoot the image.



#### To return to normal shooting

Press  (  ) on the control button again.  disappears from the LCD screen.

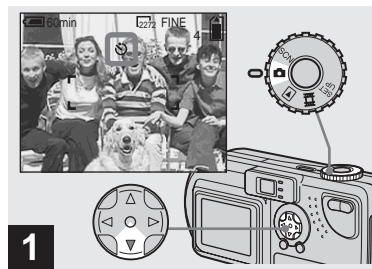
- Use the LCD screen to shoot when using the Macro feature. If you use the finder, the limits of what you see and what you actually shoot may be different.



**1**

➔ Set the mode dial to , and press  (  ) on the control button.

 (Self-timer) will appear on the LCD screen.

- If the menu is currently displayed, press MENU first to make the menu disappear.
- You can also carry out this operation when the mode dial is set to SCN or .

## Using the self-timer (continued)

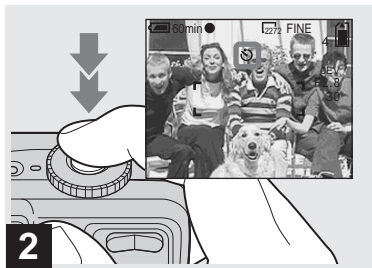

- ➔ **Center the subject in the frame, and press the shutter button fully down.**

The Self-timer lamp (page 8) will flash in orange, and you will hear a beeping sound. The image will be shot after approximately 10 seconds.

### To cancel the self-timer during the operation

Press **▼** (📷) on the control button again.

- If you stand in front of the camera and press the shutter button, the focus and the exposure may not be correctly set.

## Selecting a flash mode

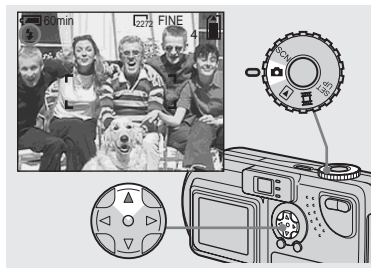



- ➔ **Set the mode dial to , and press **▲** (📷) on the control button repeatedly to select a flash mode.**

The flash mode has the following features.

**No indicator (Auto):** Based on the lighting conditions, the camera will decide if there is enough light, and will use the flash accordingly.

**📷 (Forced flash):** The flash will be used regardless of the amount of ambient light.

**📷 (No flash):** The flash will not be used.

- The recommended distance using the flash is as follows (when [ISO] is set to [AUTO]):
  - When the zoom is set all the way to the W side, 0.5 to 3.8 m (19 <sup>11</sup>/<sub>16</sub> inches to 12 feet 5 <sup>19</sup>/<sub>32</sub> inches).
  - When the zoom is set all the way to the T side, 0.6 to 2.4 m (23 <sup>5</sup>/<sub>8</sub> inches to 7 feet 10 <sup>1</sup>/<sub>2</sub> inches).
- If the menu is currently displayed, press MENU first to make the menu disappear.
- You can change the brightness of the flash using [FLASH LEVEL] in the menu settings (page 91).
- In the Auto or  (Forced flash) mode, you look at the LCD screen in a dark place, you may notice some “noise” in the image, but this will have no effect on the image you shoot.
- While the flash is being charged, the /CHG lamp flashes. After charging is completed, the lamp goes out.

## To reduce “red-eye” when shooting live subjects

The flash pre-strobes before shooting to reduce the red-eye phenomenon. Set [RED EYE REDUCTION] to [ON] in the SET UP settings (page 93). “” appears on the LCD screen.



- The amount of red-eye reduction possible varies according to the individual. In addition, the distance to the subject, and whether or not the subject has seen pre-strobe light begin to strobe may also reduce the effectiveness of the red-eye reduction process.

## Shooting with the AF illuminator

This is additional lighting provided to assist in focusing when shooting in dark places.

Set [AF ILLUMINATOR] (page 93) to [AUTO] in the SET UP settings. If you try to shoot under insufficient lighting conditions, “ON” appears on the LCD screen; the AF illuminator will flash automatically during the time between when the shutter button is pressed halfway down and the focus locks.

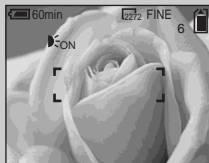

- Even when the AF illuminator flashes, but sufficient light does not reach the subject (the recommended distance for this feature is up to 2.8m (9 feet 2 1/4 inches) (wide), 1.6m (5 feet 3 inches) (tele), or the subject has weak contrast, the camera may not focus properly.

- If AF illuminator light misses the center of the image somewhat, the camera will focus properly as long as it reaches the subject.
- When the focus is adjusted manually, the AF illuminator does not function.
- In the following Scene selection modes (page 30), the AF illuminator will not function.
  - When shooting in Twilight mode
  - When shooting in Landscape mode
- The AF illuminator is a bright light. There are no safety hazards, but when shooting at short distances, do not aim it directly at the subject’s eyes.

## Shooting with the finder

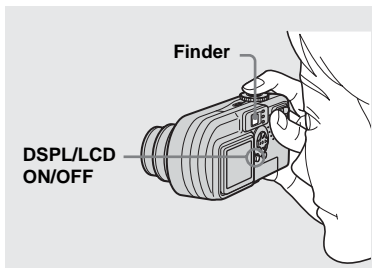

The finder is convenient when you want to save battery power, or when it is difficult to confirm the image using the LCD screen. Each time you press DSPL/LCD ON/OFF, the display changes in the following order.



**All of the indicators are turned off (only the shooting information is displayed)**

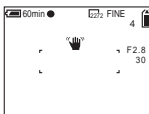

↓  
**The LCD screen is turned off.**

↓  
**All of the available indicators are turned on.**



- For details on the items displayed, see page 99.
- Just as with the AE/AF lock indicator on the LCD screen, when the AE/AF lock lamp of the finder section stops flashing and remains on, you can start shooting (page 22).
- When the LCD screen is turned off, the digital zoom does not function (page 24).
- When the LCD screen is turned off, if you press  (Flash mode)  (Self-timer)  (Macro), the image will be displayed on the screen for approximately two seconds so you can check or change the setting.

## Shooting with the date and time inserted

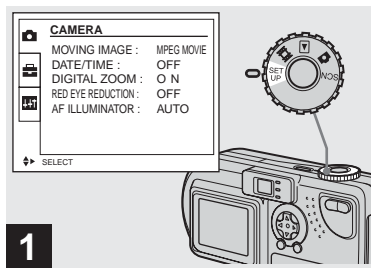

### ➔ Set the mode dial to SET UP.

The SET UP screen is displayed.

- When images are shot with the date and time inserted, the date and time cannot be removed later.
- When shooting images with the date and time inserted, the actual date and time are not displayed on the LCD screen, instead, “[DATE]” is displayed in the upper left portion of the LCD screen. The actual date and time are displayed when the image is played back.
- When you chose [DATE] in Step **3**, the date will be inserted in the order set in “Setting the date and time” (page 16).

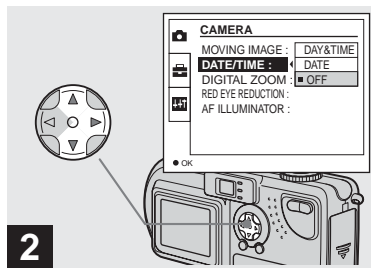

### ➔ Select (CAMERA) using ▲/▼ on the control button and press ►. Select [DATE/TIME] using ▲/▼ and press ►.

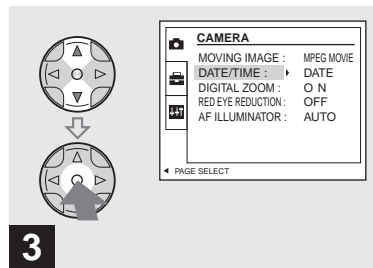

### ➔ Select the type of data to be inserted using ▲/▼ on the control button, then press the center ●.

**DAY&TIME:** Inserts the date and the time of shooting into the image

**DATE:** Inserts the year, the month and the date of shooting into the image

**OFF:** Does not insert date/time data into the image

After the setting has been completed, set the mode dial to , and continue your shooting.

- You can also carry out this operation when the mode dial is set to SCN.
- The settings made here will be saved even when the power is turned off.

## Shooting according to scene conditions (Scene selection)

### Twilight mode



### Twilight portrait mode



### Landscape mode



When shooting at night, shooting people at night, or shooting landscapes, use the modes listed below to increase the quality of your images.

### Twilight mode

Under dark lighting conditions, you can shoot using the Twilight mode, and still get good images. However, because the shutter speed is slower under these conditions, we recommend you use a tripod.

- The flash cannot be used.

### Twilight portrait mode

Use this mode when shooting people in the foreground at night.

Because the shutter speed is slow, it is recommended that you use a tripod.

- Allows you to shoot images of people in the foreground with distinct outlines without losing the feeling that you are shooting at night.
- The flash automatically strobos.

### Landscape mode

Focuses on images far away, so is convenient for shooting landscapes at a distance.

- You cannot shoot in Macro mode.
- The flash auto mode cannot be selected.

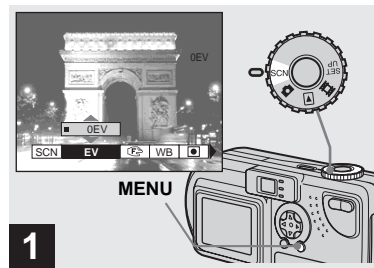

➔ Set the mode dial to SCN, and press MENU.

The menu appears.

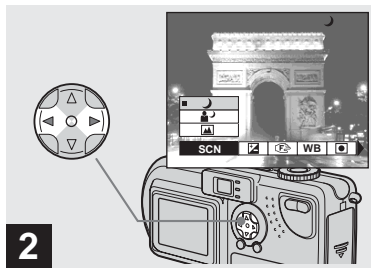

**2**  
 → Select [SCN] using ◀/▶ on the control button.

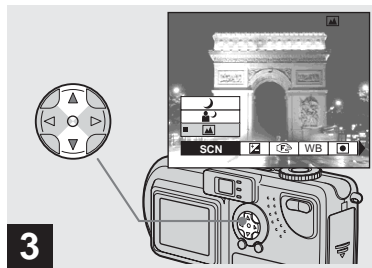

**3**  
 → Select the desired mode using ▲/▼ on the control button.

The mode will be set to your choice. When the setting is completed, press MENU. The menu disappears from the screen.

#### To cancel the Scene selection

Set the mode dial to something other than SCN.

- The settings made here will be saved even when the power is turned off.

## NR slow shutter

In Twilight or Twilight portrait mode, when the shutter speed value slower or equal to than a 1/2 second is selected, “NR” is displayed before the shutter speed indication, and the camera automatically changes to the NR slow shutter mode.

The NR slow shutter mode removes noise from recorded images, providing clear images. To eliminate the effects of vibration, use of a tripod is recommended.



Press the shutter button fully down.

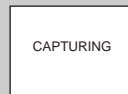

Then the screen turns black.

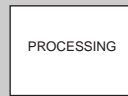

Finally, when “PROCESSING” disappears, the image has been recorded.

# Viewing images on the LCD screen of your camera

## Single (single image display)

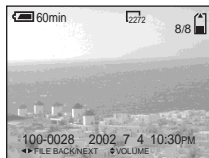

You can see the images you shoot with this camera almost immediately on the LCD screen. This camera offers the following three methods for viewing your images.

### Single (single image display)

You can view one image at a time, occupying the entire screen.

### Index (nine images display)

Nine images will be displayed simultaneously in separate panels on the screen.

### Index (three images display)

Three images will be displayed simultaneously in separate panels on the screen. Various items of image information will also be displayed.

## Index (nine images display)



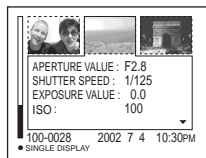

## Index (three images display)

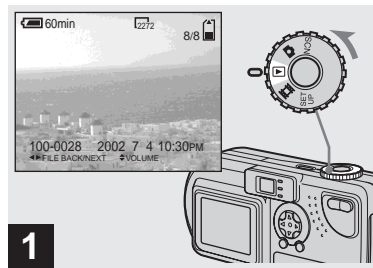

- For movies, see page 72.
- For information on the various symbols displayed, see page 101.

## Viewing single images



➔ **Set the mode dial to , and turn on the power.**

The last image you shot will be displayed.



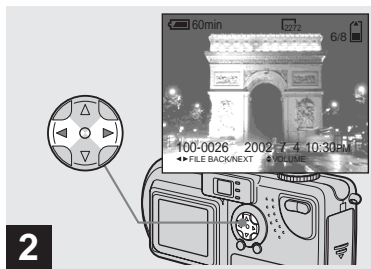

➔ **Select a still Image using ◀▶ on the control button.**

◀ : Displays the previous image.

▶ : Displays the next image.

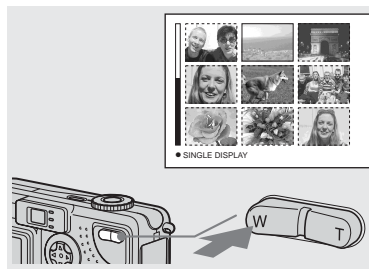

➔ **Press the zoom W button once.**

The display switches to the **Index (nine images) screen**.

**To display the previous (next) Index screen**

Press ▲/▼/◀/▶ on the control button to move the yellow frame up/down/left/right.

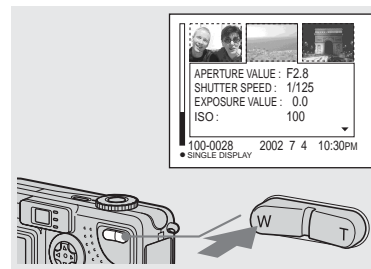

➔ **Press the zoom W button once more.**

The display switches to the **Index (three images) screen**.

When you press ▲/▼ on the control button, the remaining image information is displayed.

**To display the previous (next) Index screen**

Press ◀/▶ on the control button.

**To return to the Single image screen**

Repeatedly press the zoom T button, or press the center ● on the control button.

# Viewing images on a TV screen

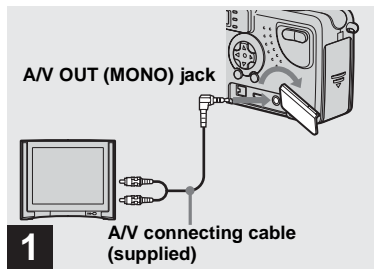

➔ Using the A/V connecting cable, connect the A/V OUT (MONO) jack of the camera to the audio/video input jacks of the TV set.

If your TV has stereo type input jacks, connect the audio plug (black) of the A/V connecting cable to the Lch jack.

- Connect the A/V connecting cable to the camera and the TV set only after confirming that both are turned off.

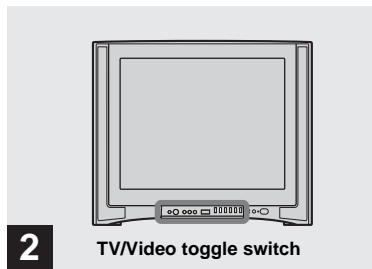

➔ Turn on the power of the TV set, and set the TV/Video toggle switch of the TV to "Video."

- Depending on your TV set, the name and location of this switch may be different.

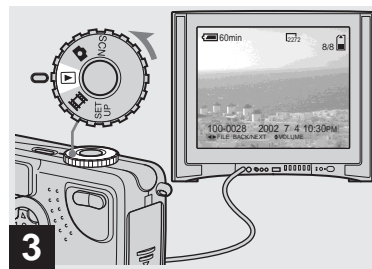

➔ Set the mode dial to , and turn on the camera.

Press  on the control button to select an image.

- When using this feature, it may be necessary to switch the video output signal to match that of your TV system (page 94).

### **Watching the playback picture on TV**

If you want to view the playback picture on a TV, you need a TV having a video input jack and a video connecting cable. The color system of the TV must be the same as that of your digital still camera. Check the following list:

#### **NTSC system**

Bahama Islands, Bolivia, Canada, Central America, Chile, Colombia, Ecuador, Jamaica, Japan, Korea, Mexico, Peru, Surinam, Taiwan, the Philippines, the U.S.A., Venezuela, etc.

#### **PAL system**

Australia, Austria, Belgium, China, Czech Republic, Denmark, Finland, Germany, Holland, Hong Kong, Italy, Kuwait, Malaysia, New Zealand, Norway, Portugal, Singapore, Slovak Republic, Spain, Sweden, Switzerland, Thailand, United Kingdom, etc.

#### **PAL-M system**

Brazil

#### **PAL-N system**



Argentina, Paraguay, Uruguay

#### **SECAM system**

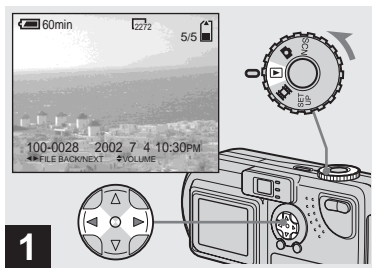

Bulgaria, France, Guiana, Hungary, Iran, Iraq, Monaco, Poland, Russia, Ukraine, etc.

# Deleting images



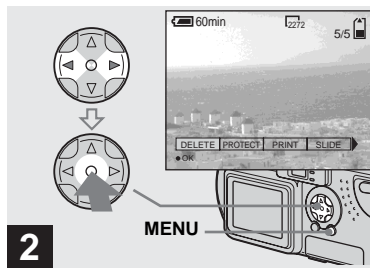

- 1** → Set the mode dial to , and turn on the camera. Select an image to be deleted using  on the control button.



- 2** → Press MENU. Select [DELETE] using  on the control button, then press the center .

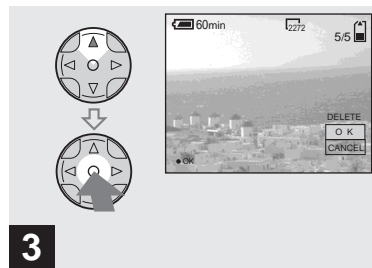

The image has not yet been deleted at this point.



- 3** → Select [OK] using  on the control button, then press the center .

“MEMORY STICK ACCESS” appears on the screen. When this message disappears, the image has been deleted.

### To cancel the deletion

Select [CANCEL] using  on the control button, then press the center .

## Deleting on the Index (nine images) screen

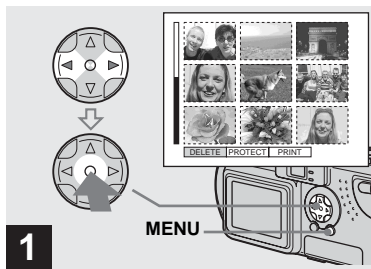

- While an Index (nine images) screen (page 33) is displayed, press MENU. Select [DELETE] using ◀/▶ on the control button, then press the center ●.

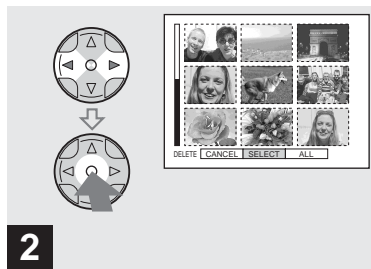



- Select [SELECT] using ◀/▶ on the control button, then press the center ●.

### To delete all the images

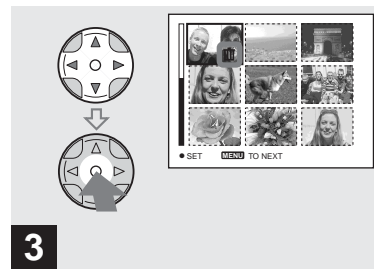
Select [ALL] using ◀/▶ on the control button, then press the center ●. Next, select [OK], then press the center ●. To cancel the deletion, select [EXIT], then press the center ●.



- Select the image you want to delete using ▲/▼/◀/▶ on the control button, then press the center ●.

The  mark is placed on the selected image. At this point, the image has not yet been deleted. Put the  mark on all of the images you want to delete.

- To cancel your selection, press the center ● one more time.

## Deleting on the Index (nine images) screen (continued)

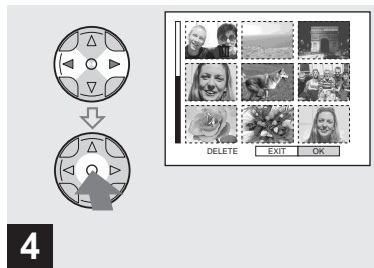

- Press MENU.  
Select [OK] using ◀▶ on the control button, then press the center ●.

When “MEMORY STICK ACCESS” disappears, the images have been deleted.

### To cancel the deletion

Select [EXIT] using ◀ on the control button, then press the center ●.

## Deleting on the Index (three images) screen

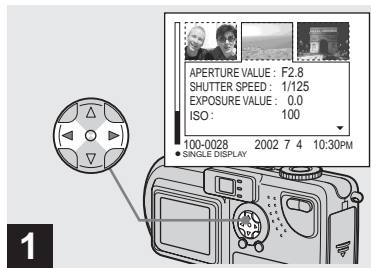

- While an Index (three images) screen (page 33) is displayed, move the image you want to delete to the center using ◀▶ on the control button.

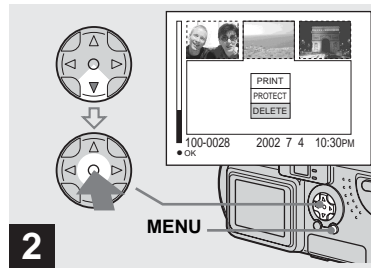

- Press MENU.  
Select [DELETE] using the ▼ on the control button, then press the center ●.

At this point, the image has not yet been deleted.

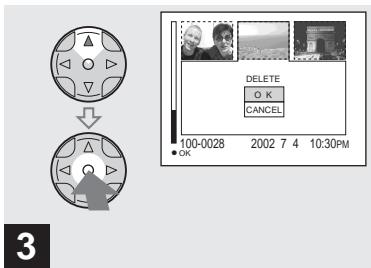
**3**

→ **Select [OK] using ▲ on the control button, then press the center ●.**

When “MEMORY STICK ACCESS” disappears, the image has been deleted.

**To cancel the deletion**

Select [CANCEL] using ▼ on the control button, then press the center ●.

# Formatting a "Memory Stick"

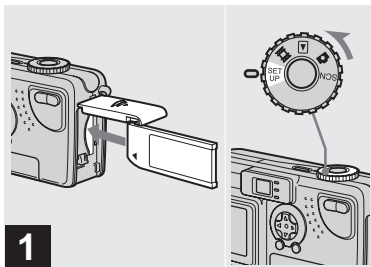

- 1** → Insert the "Memory Stick" you want to format into the camera. Set the mode dial to SET UP, and turn on the power.

- The term "formatting" means preparing a "Memory Stick" to record images; this process is also called "initialization." The "Memory Stick" provided with this camera, and those available commercially, are already formatted, and can be used immediately.
- When you format a "Memory Stick," be aware that all of the images in the "Memory Stick" will be permanently deleted.

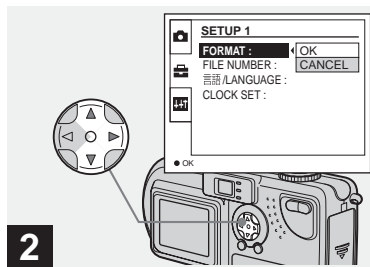

- 2** → Select  (SETUP 1) using ▲/▼ on the control button. Select [FORMAT] using ►, then, press ►. Select [OK] using ▲/▼, then press the center ●.

## To cancel the formatting

Select [CANCEL] using ▼ on the control button, then press the center ●.

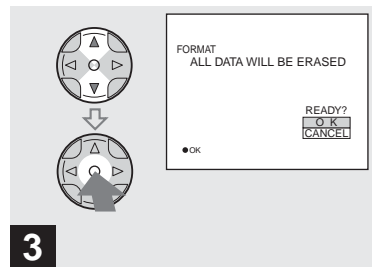

- 3** → Select [OK] using ▲/▼ on the control button, then press the center ●.

The "FORMATTING" message appears. When this message disappears, the format is complete.





# Copying still images to your computer

Follow the steps below to copy the images you shot to your computer.

## Steps required by your OS (Operating System)

OS	Steps
Windows 98/98SE/2000/Me	Steps ❶ to ❺ (pages 42 to 46, 48)
Windows XP	Steps ❷ to ❺ (pages 43, 44, 46 to 48)
Mac OS 8.5.1/8.6/9.0/9.1/9.2, Mac OS X (v10.0/v10.1)	Page 51

- Step ❶ may be unnecessary depending on your OS.
- After you complete the installation of the USB driver, Step ❶ is unnecessary.

## Recommended computer environment

### Recommended Windows environment

OS: Microsoft Windows 98, Windows 98SE, Windows 2000 Professional, Windows Millennium Edition, Windows XP Home Edition, or Windows XP Professional

An OS installed at the factory (not upgraded) is required for correct operations. We cannot guarantee operations for operating systems not listed above.

CPU: MMX Pentium 200 MHz or faster  
Display:

Resolution of 800×600 dots or higher, High Color (16-bit color, 65 000 colors) or more

USB connector:

Provided as standard equipment

### Recommended Macintosh environment

OS: Mac OS 8.5.1, 8.6, 9.0, 9.1, 9.2, or Mac OS X (v10.0/v10.1)

An OS installed at the factory is required for correct operations. For the following models, update your OS to Mac OS 9.0 or 9.1.

- iMac with Mac OS 8.6 installed at the factory, and a slot loading type CD-ROM drive
- iBook or Power Mac G4 with the Mac OS 8.6 installed at the factory

Display:

Resolution of 800×600 dots or higher, 32 000-color mode or higher

USB connector:

Provided as standard equipment

- If you connect two or more USB devices to your computer at one time, some devices, including your camera, may not work, depending on the type of USB device.
- Operations are not guaranteed when using a USB hub.
- Operations are not guaranteed for all the recommended environments mentioned above.

## USB mode

There are two modes for a USB connection, [NORMAL] and [PTP] modes. The factory setting is the [NORMAL] mode. This section describes the USB connection using the [NORMAL] mode.

## Communication with your computer (for Windows users only)

If you recover your computer from the suspend or sleep mode, communication between your camera and your computer may not recover at the same time.

## When a USB connector is not provided on your computer

When neither a USB connector nor a “Memory Stick” slot is provided, you can copy images using an additional device. See the Sony Website for details.  
<http://www.sony.net/>



# Installing the USB driver

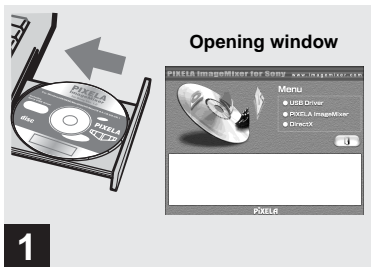

98	2000
98SE	Me



1

→ Turn on your computer, and insert the supplied CD-ROM into the CD-ROM drive.

**Do not connect your camera to your computer at this time.**

The opening window appears. If it does not appear, double-click  (My Computer) →  (ImageMixer) in order.

- This section describes how to establish a USB connection using Windows Me as an example. Required operations may be different depending on your OS.
- **Shut down all other applications before installation of the driver.**
- When you are using Windows 2000, log on as Administrator.

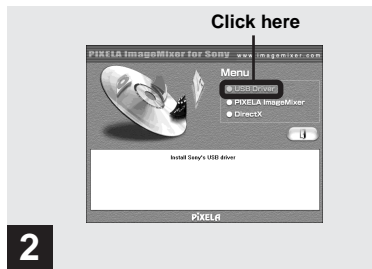

2

→ Click [USB Driver] on the opening window.

The "InstallShield wizard" window appears.

- Set the display to 800×600 dots or higher and High Color (16-bit color, 65 000 colors) or more. If it is set to less than 800×600 dots and 256 colors, the installation window does not appear.

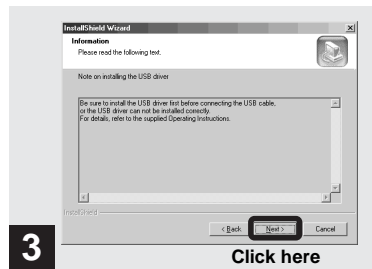

3

→ Click [Next]. When the "Information" window appears, click [Next].

The USB driver installation starts. When the installation is completed, the window informs you of completion. Eject the CD-ROM.



## Preparing your camera

98 2000 XP  
98SE Me



➔ Click [Yes, I want to restart my computer now], then click [Finish].

Your computer restarts. Then, you can establish the USB connection.

- You can use the “PIXELA ImageMixer for Sony” software to copy images to your computer. To install this software, click [PIXELA ImageMixer], on the opening window, then follow instructions on each succeeding window.
- Be sure to install DirectX when using the “PIXELA ImageMixer for Sony” software. Click [DirectX] and follow instructions on each succeeding window. Your computer restarts when the installation is completed.

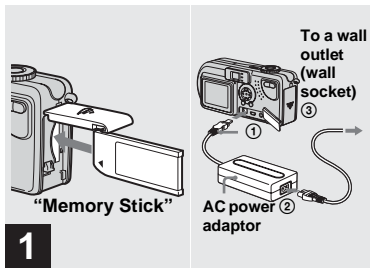

➔ Insert the “Memory Stick” with the images you want to copy into the camera. Connect the camera and the AC power adaptor, and plug the adaptor into a wall outlet (wall socket).

- For further details on the AC power adaptor, see page 14.
- For further details on the “Memory Stick,” see page 18.

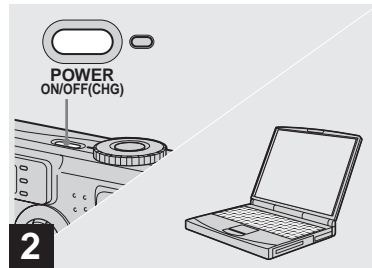

➔ Turn on your computer and camera.



## Connecting your camera to your computer

98 2000 XP  
98SE Me

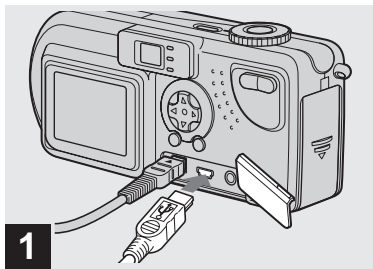

➔ **Connect the supplied USB cable to your camera. Then, connect the other end of the USB cable to your computer.**

- When using a desktop computer, connect the USB cable to the USB connector on the rear panel.
- When using Windows XP, the copy wizard automatically appears on the desktop. Proceed to page 46.

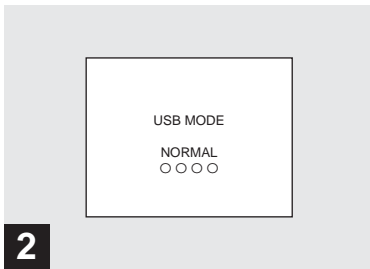

“USB MODE NORMAL” appears on the LCD screen of your camera. When a USB connection is established for the first time, your computer automatically runs the used program to recognize your camera. Wait for a while.

- If “USB MODE NORMAL” does not appear, confirm that [USB CONNECT] is set to [NORMAL] in the SET UP settings (page 94).

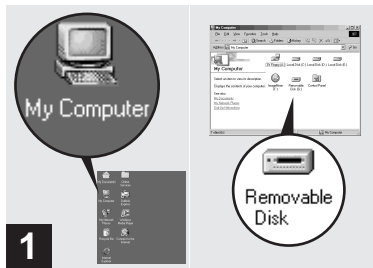

- 1** → Double-click [My Computer], then double-click [Removable Disk].

The contents of the “Memory Stick” inserted in your camera appear.

- This section describes an example of copying images to the “My Documents” folder.
- When the “Removable Disk” icon does not appear, see the next page.
- You can use the “PIXELA ImageMixer for Sony” software to copy images to your computer. For details, see the software’s help files.

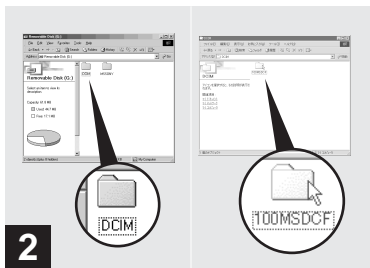

- 2** → Double-click [DCIM], then double-click [100MSDCF].

The “100MSDCF” folder opens.

- The “100MSDCF” folder contains the image files you shot using your camera.
- The folder names vary depending on the type of images they contain (page 49).

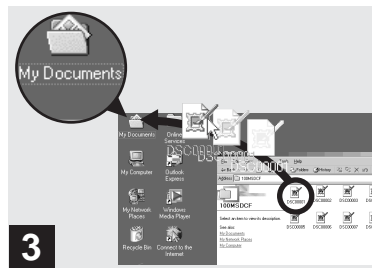

- 3** → Drag and drop the image files into the “My Documents” folder.

The image files are copied to the “My Documents” folder.

- When you try to copy an image to a folder in which an image with the same file name is stored, the overwrite confirmation message appears. When you want to overwrite the existing image with the new one, click [Yes]. When you do not want to overwrite it, click [No], then change the file name.

## When a removable disk icon is not shown

- 1 Right-click [My Computer], then click [Properties].  
The “System Properties” window appears.
- 2 Confirm if other devices are already installed.
  - ① Click [Device Manager].
  - ② Confirm if there is a [📷] Sony DSC] or [📷] Sony Handycam] with a 📷 mark in [📷] Other Devices].
- 3 If you find either of the devices above, follow the steps below to delete them.
  - ① Click [📷] Sony DSC] or [📷] Sony Handycam].
  - ② Click [Delete].  
The “Device deletion confirmation” window appears.
  - ③ Click [OK].  
The device is deleted.

Try the USB driver installation again using the supplied CD-ROM (page 42).

## 4 Copying images XP

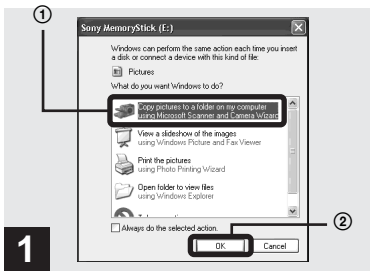

- ➔ Click [Copy pictures to a folder on my computer using Microsoft Scanner and Camera Wizard] window, then click [OK].

The “Scanner and Camera Wizard” window appears.

- When following the steps on page 44, the copy wizard appears on the desktop of your computer.

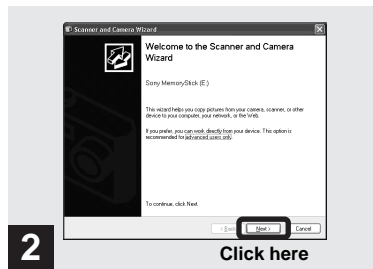

- ➔ Click [Next].

The images stored in the “Memory Stick” are displayed.

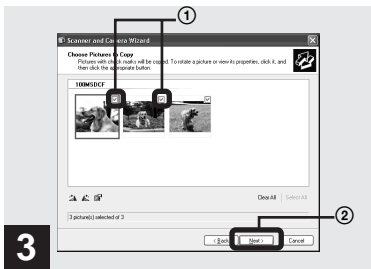

→ Click  to remove the checkmark from any images you do not want to copy to your computer, then click [Next].

The “Picture Name and Destination” window appears.

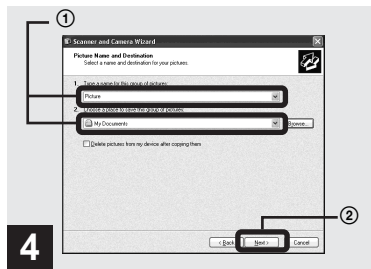

→ Specify the image file names to be copied and the copy destination, then click [Next].

Copying of the images starts. When the task is completed, the “Other Options” window appears.

- Here the “My Documents” folder is used as a copy-to folder for explanation.

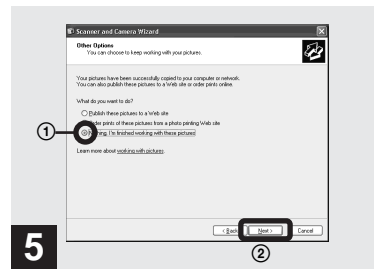

→ Click [Nothing. I'm finished working with these pictures], then click [Next].

The “Completing the Scanner and Camera Wizard” window appears.

#### 4 Copying images XP (continued)



→ Click [Finish].

The wizard window closes.

- When you want to continue copying other images, disconnect the USB cable once and reconnect it. Then, follow the process from Step 1.

#### 5 Viewing the images on your computer

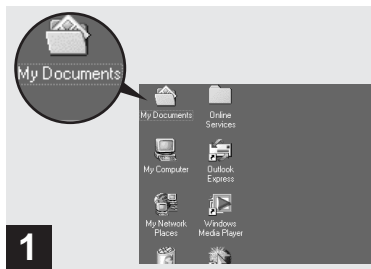

→ Double-click [My Documents] on the desktop.

The “My Documents” folder opens.

- This section describes the steps followed for copying images to the “My Documents” folder on pages 45 and 46.
- When using Windows XP, click [Start]→[My Documents] in that order.
- You can use the “PIXELA ImageMixer for Sony” software to view images on your computer. For details, see the software’s help files.

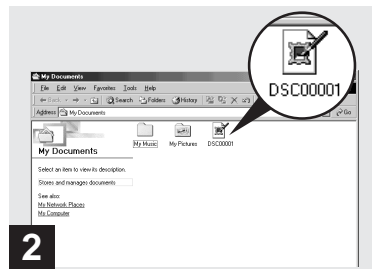



→ Double-click the desired image file.

The image file opens.



## Removing the USB cable from your computer or the “Memory Stick” from your camera during a USB connection

### For Windows 2000, Me, or XP users

- 1 Double-click  on the task tray.
- 2 Click  (Sony DSC), then click [Stop].
- 3 Confirm the device on the confirmation window, then click [OK].
- 4 Click [OK].  
This step is unnecessary for Windows XP users.
- 5 Disconnect the USB cable or remove the “Memory Stick.”

### For Windows 98 or 98SE users

Carry out only Step 5 above.

## Image file storage destinations and file names

The image files recorded with your camera are grouped as folders in the “Memory Stick,” depending on the recording modes.

### Example: when viewing folders on Windows Me

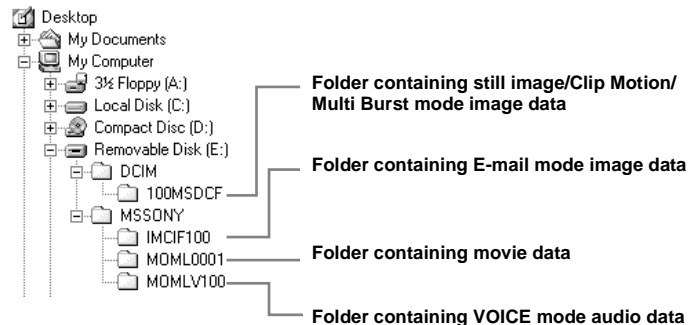

## Image file storage destinations and file names (continued)

Folder	File name	File meaning
100MSDCF	DSC0□□□□.JPG	<ul style="list-style-type: none"><li>• Still image files shot normally</li><li>• Still image files shot in<ul style="list-style-type: none"><li>– E-MAIL mode (page 61)</li><li>– VOICE mode (page 61)</li><li>– Multi Burst mode (page 59)</li></ul></li></ul>
	CLP0□□□□.GIF	<ul style="list-style-type: none"><li>• Clip Motion files shot in NORMAL mode (page 58)</li></ul>
	CLP0□□□□.THM	<ul style="list-style-type: none"><li>• Index image files of Clip Motion files shot in NORMAL mode</li></ul>
	MBL0□□□□.GIF	<ul style="list-style-type: none"><li>• Clip Motion files shot in MOBILE mode (page 58)</li></ul>
	MBL0□□□□.THM	<ul style="list-style-type: none"><li>• Index image files of Clip Motion files shot in MOBILE mode</li></ul>
IMCIF100	DSC0□□□□.JPG	<ul style="list-style-type: none"><li>• Small-size image files shot in E-MAIL mode (page 61)</li></ul>
MOML0001	MOV0□□□□.MPG	<ul style="list-style-type: none"><li>• Movie files shot normally (page 71)</li></ul>
MOMLV100	DSC0□□□□.MPG	<ul style="list-style-type: none"><li>• Audio files shot in VOICE mode (page 61)</li></ul>

### Note on the table

- The meanings of the file names are as above:
  - stands for any number within the range from 0001 to 9999.
- The numerical portions of the following files are the same.
  - A small-size image file shot in E-MAIL mode and its corresponding image file
  - An audio file shot in VOICE mode and its corresponding image file
  - An image file shot with Clip Motion and its corresponding index image file

## 5 Viewing the images on your computer



➔ **Double-click [My Documents] on the desktop.**

The “My Documents” folder opens.

- This section describes the steps followed for copying images to the “My Documents” folder on pages 47 and 48.
- When using Windows XP, click [Start]→[My Documents] in that order.
- You can use the “PIXELA ImageMixer for Sony” software to view images on your computer. For details, see the software’s help files.

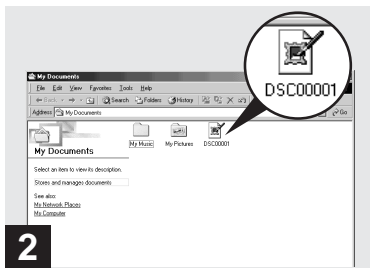



➔ **Double-click the desired image file.**

The image file opens.

### Removing the USB cable from your computer or the “Memory Stick” from your camera during a USB connection

**For Windows 2000, Me, or XP users**

- 1 Double-click  on the task tray.
- 2 Click  (Sony DSC), then click [Stop].
- 3 Confirm the device on the confirmation window, then click [OK].
- 4 Click [OK].  
This step is unnecessary for Windows XP users.
- 5 Disconnect the USB cable or remove the “Memory Stick.”

**For Windows 98 or 98SE users**

Carry out only Step 5 above.

## How to setup and operate your camera

This section describes the most frequently used menus and the SET UP screen.

### Control button

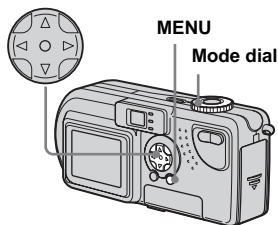

### Changing menu settings

#### 1 Press MENU.

The menu appears.

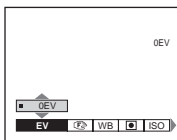

#### 2 Select the setting item you want to change using ◀▶ on the control button.

The letters and symbols of the item you select will turn yellow.

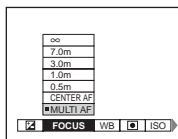

#### 3 Select the desired setting using ▲▼ on the control button.

The frame of the selected setting will turn yellow, and the setting will be made.

### To turn off the menu display

Press MENU.

### Changing items in the SET UP screen

#### 1 Set the mode dial to SET UP.

The SET UP screen appears.

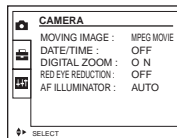

#### 2 Select the setting item you want to change using ▲▼/◀▶ on the control button.

The frame of the item you select will turn yellow.

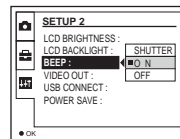

#### 3 Press the center ● on the control button to enter the setting.

### To turn off the SET UP screen display

Set the mode dial to anything other than SET UP.

## Choosing a focus method



**Mode dial:** /SCN/

### Multipoint AF

The AF range finder frame widens.



### Center AF

The AF range finder frame is only the center of the frame.

**1** Set the mode dial to either , SCN, or .

**2** Press MENU.

The menu appears.

**3** Select  (FOCUS) using , then select [MULTI AF] or [CENTER AF] using /▼.

The focus is adjusted automatically.  
The color of the AF range finder frame changes from white to green.

### Multipoint AF



### Center AF



- When you are shooting movies (MPEG movie) and you choose Multipoint AF, the distance to the center of the screen is estimated as an average, so the AF works even with a certain amount of vibration. The Center AF automatically focuses only on the center of the image, so it is convenient when you want to focus only on what you aim at.
- When you use Digital zoom or AF illuminator, priority AF movement is given to subjects in or near the center of the frame. In this case, the AF range finder is not displayed.

## Shooting with the AF lock using Center AF

Even if it is difficult to focus in Center AF shooting because the subject is not in the center of the frame, you can focus in this situation using the AF lock. For example, when you are shooting two human subjects, and there is a gap between them, the camera may focus on the background visible in the gap. In a case like this, use AF lock to ensure the subjects are in correct focus.

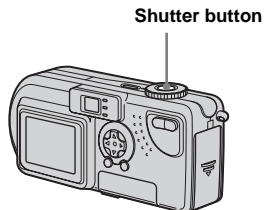

- When you are using AF lock, you can capture an image with the correct focus even if the subject is at the edge of the frame.

### 1 Compose the shot so that the subject is centered in the AF range finder, and press the shutter button halfway down.

First, the focus for the subject you are aiming at will be adjusted. When the AE/AF lock indicator stops flashing and remains on, and there is a beeping sound, focus adjustment is completed.

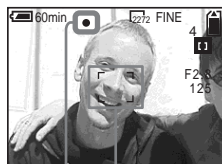

AF range finder

AE/AF lock indicator

### 2 Return to the fully composed shot, and press the shutter button fully down.

The shutter clicks, the image will be recorded with the proper focus for the human subjects.



- You can carry out the AF lock adjustment process before you press the shutter button fully down.

## Setting the distance to the subject

### – Focus preset

**Mode dial:** /SCN/

When shooting an image using a previously set distance to the subject, or when shooting a subject through a net or through window glass, it is difficult to get the proper focus in auto focus mode. This is when use of the Focus preset is convenient.

#### Control button

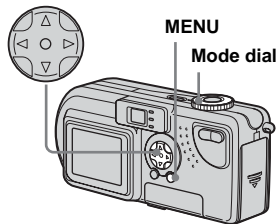

- 1** Set the mode dial to , SCN, or .
- 2** Press MENU.  
The menu appears.
- 3** Select (FOCUS) using /▶, then select the distance to the subject using ▲/▼.

You can select from the following distance settings.  
0.5m, 1.0m, 3.0m, 7.0m, ∞ (unlimited distance)

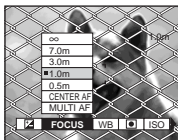

#### To return to auto focus mode

Press MENU again, select (FOCUS), then select [MULTI AF] or [CENTER AF].

- Focal point information may not show the exact distance.
- If you point the lens up or down, the error increases.
- If focus preset value flashes with [0.5m] selected, press the zoom W button until the value stops flashing.

## Adjusting the exposure

### – EV adjustment

**Mode dial:** /SCN/

Used when you want to change the automatic exposure to one of your own choice. The value can be set over a range from +2.0EV to -2.0EV, in 1/3EV increments.

- 1** Set the mode dial to , SCN, or .
- 2** Press MENU.  
The menu appears.
- 3** Select (EV) using /▶.  
The value of the exposure adjustment is displayed.



#### 4 Select the exposure adjustment value.

Select the exposure adjustment value using ▲/▼.

Make your adjustment while confirming the brightness of the background of the subject on the LCD screen.

#### To return to auto adjust mode

Return the exposure adjustment value to 0EV.

- When the subject is extremely bright or extremely dark, or when you are using the flash, the adjustment may not work.

#### Shooting techniques

In normal shooting, the camera makes automatic exposure adjustments. Check the image to be shot, if it looks like the image below, you should make manual adjustments. If you are shooting a back-lit person or a snowy scene, make your adjustments in the + plus direction; if you are shooting a dark subject that fills the screen, making your adjustments in the – direction should give the best results.



**Inadequate exposure**  
→ Adjust in the + direction



**Appropriate exposure**



**Overexposed** → Adjust in the – direction

## Spot light-metering

**Mode dial:** /SCN/

When there is backlight, or the background of the subject provides a very high contrast, you can adjust the focus to that most appropriate for your subject. You can aim at a particular point, and meter the light to adjust the focus for that point.

**Control button**

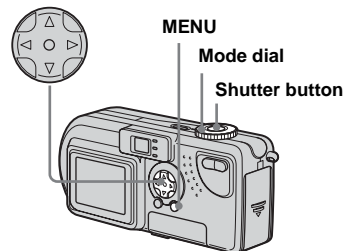

**1** Set the mode dial to , SCN, or .

**2** Press MENU.

The menu appears.



- 3** Select  (SPOT METER) using , then select [ON] using .

The Spot light-metering aiming point is displayed.

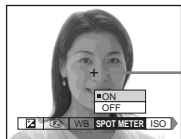

Spot light-metering aiming point

- 4** Aim the Spot light-metering aiming point at the spot you want to shoot, then shoot your image.

### To cancel Spot light-metering

In Step **3**, select [OFF]. The Spot light-metering aiming point disappears, and the camera returns to normal light-metering.

## Adjusting color tones

### – White Balance

**Mode dial:** /SCN/

When shooting images using automatic features, the white balance is set automatically in response to the condition of the subject, and the overall color balance is adjusted accordingly. When you want to fix the conditions under which the image is captured, or when shooting under special lighting conditions, you can select the settings manually.

#### **AUTO (no display)**

The white balance is adjusted automatically.

#### **(Daylight)**

Used when shooting outdoors, and for shooting at night, under neon lights, for fireworks, sunrises and sunsets.

#### **(Cloudy)**

Used when shooting under a cloudy sky.

#### **(Fluorescent)**

Used when shooting under fluorescent lights.



#### **(Incandescent)**

- Used when shooting, for example, at a party, where the lighting conditions change often
- Used in a studio, or under video lights
- Used when shooting under sodium or mercury lights

- 1** Set the mode dial to , SCN, or .

- 2** Press MENU.

The menu appears.

- 3** Select [WB] (WHITE BAL) using , then select the desired setting using .

### To return to automatic settings

In Step **3**, select [AUTO].

- Under fluorescent lights that flicker, even if you choose , the overall color of the image may show differences from the actual color.
- When the flash is triggered, the manual setting is cancelled, and the shooting of the image is done in AUTO mode.

## Shooting techniques

The color of the subject that you see will be captured according to the lighting conditions. Under the bright summer sun, everything will appear bluish, under a light sources like a light bulb, white objects will appear reddish. The human eye has an excellent ability to adjust. Even when lighting conditions change, the eye can adjust and recognize the correct color almost instantly. However, digital still cameras are greatly influenced by light. Normally, this camera adjusts automatically, but if you notice that the color of the entire image seems to be a bit unnatural when replaying an image on the LCD screen, it is recommended that you adjust the white balance.

## Shooting multiple frames

### – Clip Motion

#### Mode dial:

You can shoot a number of still images consecutively (GIF animation). Because the file size is small, these images are ideal for use on a home page, or for attaching to an e-mail message.

- Clip Motion images are restricted to color levels of 256 colors and below. This is a characteristic of GIF format recording. For this reason, the image quality of some images may deteriorate.

#### NORMAL (160×120)

The maximum number of frames you can shoot in one Clip Motion shot is 10. This is the best choice for use on a home page.

#### MOBILE (120×108)

Two frames is the maximum number that can be shot in Clip Motion in this mode.





- MOBILE mode has strict file size limits, so picture quality falls accordingly.
- For the number of images you can record using Clip Motion, see page 88.

### Before operation

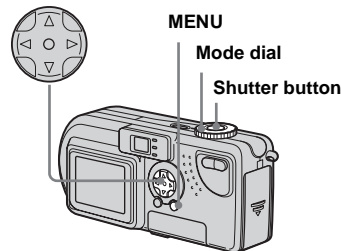
Set [MOVING IMAGE] to [CLIP MOTION] in the SET UP settings (pages 52, 93).

#### Control button



- 1 Set the mode dial to .**
- 2 Press MENU.**  
The menu appears.
- 3 Select  (IMAGE SIZE) using , then select the desired mode using .**

#### 4 Shoot one frame.



#### 5 Shoot the next frame.

Press the shutter button once to shoot the next frame, then repeat this operation until you have shot the desired number of frames.

#### 6 Press the center ●.

All of the frames will be saved in the "Memory Stick."

- If you do not complete Step **6**, the image will not be saved in the "Memory Stick." Up to that point, the image is saved temporarily in the camera.
- In Clip Motion mode, the date and time will not be recorded.
- When you view Clip Motion images using the Index screen, the images may appear different from the actual image recorded.
- GIF files made on other cameras may not display correctly on this camera.

### To delete shot images in the midst of shooting

- 1 In Steps **4** or **5**, press ◀ (⊖).  
Shot images will be played back in order, playback stops when the last image is reached.
- 2 Press MENU, and select either [DELETE LAST] or [DELETE ALL], then press the center ●.
- 3 Select [OK], then press the center ●. If you chose [DELETE LAST] in Step **2**, repeat Steps **1** to **3** to delete the images in order, from the latest one shot.

## Shooting in Multi Burst mode

### – Multi Burst

#### Mode dial:

Pressing the shutter button once records 16 frames in a row. This is convenient for checking your form in sports, for example. You can set the interval between frames using the menu.



## Before operation

Set [MOVING IMAGE] to [MULTI BURST] in the SET UP settings (pages 52, 93).

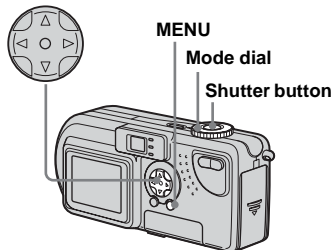

### Control button



**1** Set the mode dial to .

**2** Press MENU.

The menu appears.

**3** Select  (INTERVAL) using , then select the desired between-frame interval using .

You can choose the between-frame interval from among the following.  
NTSC: 1/7.5 sec., 1/15 sec., 1/30 sec.  
PAL: 1/6.3 sec., 1/12.5 sec., 1/25 sec.

(For information on NTSC/PAL, see page 92.)





**4** Press the shutter button.

16 frames will be recorded as one image (image size: 1280×960).

## To delete shot images

When using this mode, you cannot delete only certain frames. When you delete images, all 16 of the frames are deleted at the same time.

**1** Set the mode dial to .

**2** Press MENU and select [DELETE], then press the center .

**3** Select [OK], then press the center .  
All of the frames are deleted.

- When you play back images recorded in Multi Burst mode, the 16 frames will be played back in order, with a fixed interval between them.
- When the images are played back on a computer, the 16 frames you shot will all be displayed at the same time as part of one image.

- When Multi Burst images are played back on a camera without the Multi Burst feature, the 16 frames will all be displayed at the same time, as part of one image, just as they are on a computer.
- For the number of images that can be recorded, see page 88.
- The flash cannot be used.
- The date and time cannot be inserted.

---

## Shooting still images for e-mail

### – E-MAIL



#### Mode dial: /SCN

You can shoot images and save them in a file that is small enough to attach to an e-mail message. The normal mode image that was selected using the  (IMAGE SIZE) item (page 19) is also recorded.

**1** Set the mode dial to , or SCN.

**2** Press MENU.

The menu appears.

**3** Select [MODE] (REC MODE) using , then select [E-MAIL] using .

**4** Shoot your image.

#### To return to normal mode

In Step **3**, select [NORMAL].

- For instructions on how to attach your images to an e-mail message, refer to the Help files of the e-mail software you are using.

---

## Shooting still images with audio files

### –VOICE



#### Mode dial: /SCN

You can shoot still images with audio files.

**1** Set the mode dial to  or SCN.

**2** Press MENU.

The menu appears.

**3** Select [MODE] (REC MODE) using , then select [VOICE] using .

**4** Shoot your image.

If you press and release the shutter button, sound is recorded for five seconds.

If you hold down the shutter button, sound is recorded until you release the shutter button for up to 40 seconds.

#### To return to normal mode

In Step **3**, select [NORMAL].

- To view images recorded in VOICE mode, carry out the same procedure described in “Viewing movies on the LCD screen” (page 72).

## Adding special effects

### – Picture Effect

**Mode dial:** /SCN/

You can add special effects to bring out the contrast in your images.

#### SOLARIZE



Like an illustration with clearly delineated bright and dark portions

#### B&W



In black and white

#### SEPIA



Colored to look like an old photograph

#### NEG.ART



Made to look like a negative image

Control button



MENU

Mode dial

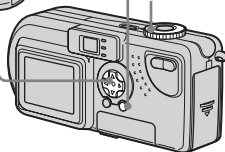

**1** Set the mode dial to , SCN, or .

**2** Press MENU.

The menu appears.

**3** Select [PFX] (P.EFFECT) using / , then select the desired mode using / .

### To cancel Picture Effect

In Step **3**, select [OFF].

## Enlarging a portion of a still image

### Mode dial:



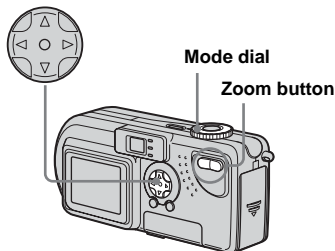

You can enlarge an image up to five times the size of the original image. You can also record the enlarged image as a new file.

### Control button



### Enlarging an image

– Playback zoom

- 1** Set the mode dial to .
- 2** Display the image you want to enlarge.
- 3** Press the zoom T button to enlarge the image.
- 4** Press  repeatedly to select a portion of the image to enlarge.



- ▲: To view a portion of the top of the image
- ▼: To view a portion of the bottom of the image
- ◀: To view a portion of the left side of the image
- ▶: To view a portion of the right side of the image

- 5** Press the zoom T button repeatedly, the portion of the image selected in Step **4** will be enlarged.



### To cancel enlarged viewing

Press the center .

- You cannot use Playback zoom with movies (MPEG movie), or images recorded in Clip Motion/Multi Burst modes.
- If you press the zoom W button when you are viewing images that have not been enlarged, the Index screen will appear (page 33).
- The images displayed in Quick Review (page 23) can be enlarged using the procedures outlined in Steps **3** to **5**.

## Recording an enlarged image – Trimming

- 1** After you have viewed an image using playback zoom, press MENU.
- 2** Select [TRIMMING] using  $\blacktriangleright$ , then press the center  $\bullet$ .
- 3** Select the image size using  $\blacktriangle$ / $\blacktriangledown$ , then press the center  $\bullet$ .

The image is recorded, and the screen image returns to the size it was before enlargement.

- The trimmed image is recorded as the newest file, and the original image is retained.
- The trimmed image may suffer some deterioration in image quality
- You cannot trim an image using the 3:2 image size.

## Playing back successive images

### – Slide show

**Mode dial:**  $\blacktriangleright$

You can play back recorded images in succession, one after another. This is useful for checking your images, or for giving a presentation.

**Control button**

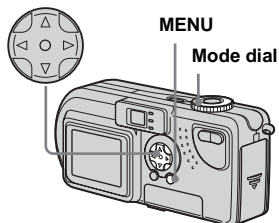

- 1** Set the mode dial to  $\blacktriangleright$ .
- 2** Press MENU.

The menu appears.

- 3** Select [SLIDE] using  $\blacktriangleleft$ / $\blacktriangleright$ , then press the center  $\bullet$ .

Select an interval from those listed below.

INTERVAL settings  
3 sec/5 sec/10 sec/30 sec/1 min

REPEAT

ON:Plays the images back repeatedly.  
OFF:Plays through the images one time and then stops.

- 4** Select [START] using  $\blacktriangle$ / $\blacktriangledown$ / $\blacktriangleleft$ / $\blacktriangleright$ , then press the center  $\bullet$ .

The slide show begins.

### To cancel the Slide show setting

In Step **3**, select [CANCEL].

### To stop the playback of the Slide show

Press the center  $\bullet$ , select [EXIT] using  $\blacktriangleright$ , then press the center  $\bullet$ .



## Skip to the next/previous image

Press the ► (next), or the ◀ (previous).

- The interval settings are just guidelines. The actual intervals differ, based on factors like the size of the image.

## Rotating still images

**Mode dial:** ►

Images shot when holding the camera vertically can be rotated and displayed horizontally.



- 1** Set the mode dial to ►, and display the image you want to rotate.
- 2** Press MENU.  
The menu appears.
- 3** Select [ROTATE] using ◀/►, then press the center ●.
- 4** Select ↶ ↷ using ▲/▼, and rotate the image using ◀/►.
- 5** Select [OK] using ▲/▼, then press the center ●.

### To cancel the rotation

In Step **4**, select [CANCEL].

- Protected images, movies (MPEG movie), or images recorded in Clip Motion/Multi Burst modes cannot be rotated.
- Images shot on other cameras may not rotate correctly on this camera.
- When viewing images on a computer, the image viewing software used may not handle the rotation information correctly.

## Protecting images

### – Protect

Mode dial: ►

To prevent accidental erasure of an important image, you can protect it.

Control button

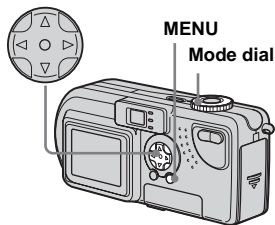

For the single screen

- 1 Set the mode dial to ►.
- 2 Display the image you want to protect using ◀/▶.
- 3 Press MENU.
- 4 Select [PROTECT] using ◀/▶, then press the center ●.

The menu appears.

The image currently being displayed is now protected, and a ◯➔ (Protect) mark is shown on the screen.

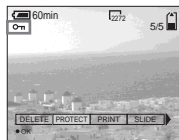

### To cancel the protection

In Step 4, press the center ● again. The ◯➔ mark disappears.

For the Index (nine images) screen

- 1 Set the mode dial to ►, press the zoom W button once to switch to the Index (nine images) screen appears.
- 2 Press MENU.
- 3 Select [PROTECT] using ◀/▶, then press the center ●.
- 4 Select [SELECT] using ◀/▶, then press the center ●.
- 5 Select the image you want to protect using ▲/▼/◀/▶, then press the center ●.

A ◯➔ (Protect) mark is placed on the selected image.



**6** To protect other images, repeat Step **5**.

**7** Press MENU.

The menu appears.

**8** Select [OK] using the **▶**, then press the center **●**.

The selected image is protected.

### To cancel the protection

Select [CANCEL] in Step **4** or select [EXIT] in Step **8**.

### To release protection

In Step **5**, using **▲/▼/◀/▶**, select an image for which you want to release protection, and press the center **●**. Repeat this operation for all the images for which you want to release protection. Then, press MENU, select [OK], and press the center **●**.

### To protect all your images

In Step **4**, select [ALL], then press the center **●**. Next, select [ON], then press the center **●**.

### To release all protection

In Step **4**, select [ALL], and press the center **●**. Then select [OFF], and press the center **●**.

*For the Index (three images) screen*

**1** Set the mode dial to **▶**, press the zoom W button twice to switch to the Index (three images) screen.

**2** Move the image you want to protect to the center using **◀/▶**.

**3** Press MENU.

The menu appears

**4** Select [PROTECT] using **▲/▼**, then press the center **●**.

The center image is protected, and a **🔒** (Protect) mark is placed on that image.

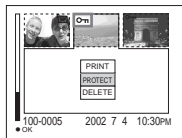

**5** To protect other images, move the image you want to protect to the center using **◀/▶**, and repeat Step **4**.

### To release protection

In Step **4**, select the image from which you want to release protection, and press the center **●**. To release protection from all of your images, repeat this process for each of them.

## Changing image size

### – Resize

**Mode dial:** 

You can change the size of your images, and record them as new files.

You can change your images to the following sizes.



2272×1704 (DSC-P9 only), 2048×1536 (DSC-P7 only), 1600×1200, 1280×960, 640×480

After the resizing is finished, the original image is retained.

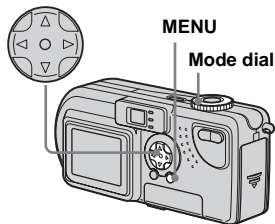
#### Control button





**1** Set the mode dial to .

**2** Select the image for which the size is to be changed using  .

**3** Press **MENU**.

The menu appears

**4** Select **[RESIZE]** using , then press the center .

**5** Select the new size using , then press the center .

The resized image is recorded as the newest file.

### To cancel the resizing

In Step **5**, select **[CANCEL]**.

- Movies (MPEG movie), or images recorded in Clip Motion/Multi Burst modes cannot be resized.
- When images are resized from a smaller to a larger size, the image quality will deteriorate.
- 3:2-sized images cannot be resized.
- If you try to resize a 3:2-sized image, black bands will appear at the top and bottom of the image.

## Choosing images to print

### – Print mark







#### Mode dial:

You can designate certain images to be printed.

This is convenient when you want to have images printed in shops that follow DPOF (Digital Print Order Format) specifications.

- Print marks cannot be placed on movies (MPEG movie) or images recorded in Clip Motion mode.
- In E-MAIL mode, the Print mark will be placed on the normal size image that was recorded at the same time.
- You can place a print mark on images shot using Multi Burst mode; all the images will be printed on one sheet divided into 16 panels.



For the single screen

- 1** Set the mode dial to .
- 2** Display the image you want to print using  .
- 3** Press MENU.  
The menu appears.
- 4** Select [PRINT] using  , then press the center .

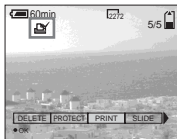











A  (Print) mark is placed on this image.



### To delete the Print mark

In Step **4**, press the center  again. The  mark disappears.

For the Index (nine images) screen

- 1** Set the mode dial to  and press the zoom W button once to switch to the Index (nine images) screen.
- 2** Press MENU.  
The menu appears.
- 3** Select [PRINT] using  , then press the center .
- 4** Select [SELECT] using  , then press the center .
- 5** Select the images you want to print using    , then press the center .

A  (Print) mark is placed on the selected image.



- 6** To print other images, repeat Step **5** for each of them.

## 7 Press MENU.

The menu appears

## 8 Select [OK] using ►, then press the center ●.

The setting of the  mark is completed.

## To delete a Print mark

In Step 5, select an image using ▲/▼/◀/▶, and press the center ●.

## To delete all the Print marks placed on all of your images

In Step 4, select [ALL], then press the center ●. Next, select [OFF], then press the center ●.

## To cancel the Print mark

In Step 4, select [CANCEL], or select [EXIT] in Step 8.

*For the Index (three images) screen*

1 Set the mode dial to , press the zoom W button twice to switch to the Index (three images) screen.

2 Move the image you want to print to the center using ◀/▶.

3 Press MENU.

The menu appears.

4 Select [PRINT] using ▲/▼, then press the center ●.

A  (Print) mark is placed on the center image.

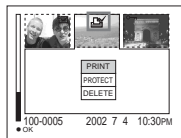

5 To print other images, move the image you want to print to the center using ◀/▶, and repeat Step 4.

## To delete a Print mark

In Step 4, press the center ● again. The  mark disappears.

## Shooting movies

### Mode dial:

You can shoot movies (MPEG movies).

### Before operation

Set [MOVING IMAGE] to [MPEG MOVIE] in the SET UP settings (pages 52, 93).

#### Control button

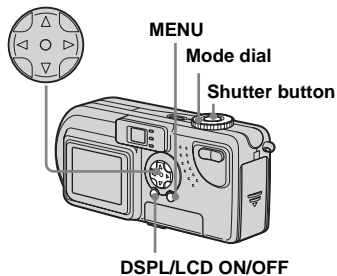

**1** Set the mode dial to .

**2** Press MENU.

The menu appears.

**3** Select  (IMAGE SIZE) using , and select the desired mode using .

You can choose from 320 (HQX), 320×240, or 160×112.

See page 88 for the recording time allowed for each screen size.

**4** Press the shutter button fully down.

“RECORDING” appears on the screen and the camera starts recording the image.



- When the capacity of the “Memory Stick” is used up, recording stops.
- For details on the recording time for movies, see page 88.

**5** Press the shutter button fully down again to stop recording.

### Indicators on the screen while you are shooting movies

These indicators are not recorded.

Each time you press DSPL/LCD ON/OFF, the status of the LCD screen changes as follows: Indicators OFF → LCD OFF → Indicators ON. See page 100 for a detailed description of the indicated items.

### To shoot close-ups (Macro)

Set the mode dial to  and follow the procedure on page 24.

### To shoot with a self-timer

Set the mode dial to  and follow the procedure on page 25.

- You cannot use a flash.
- You cannot write the date and time on the image.
- You cannot use the zoom while shooting movies.

## Viewing movies on the LCD screen

### Mode dial:

You can view movies on the LCD screen of the camera and hear sounds from the speaker of the camera.

#### Control button

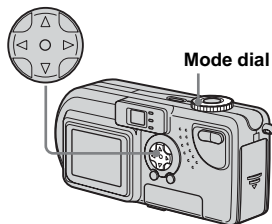

### 1 Set the mode dial to .

### 2 Select the desired movie using .

Movies are displayed a size smaller than still images.

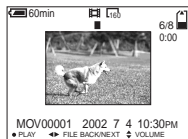

### 3 Press the center .

The movie images and sound are played back.

 (playback) appears on the LCD screen while a movie is playing back.

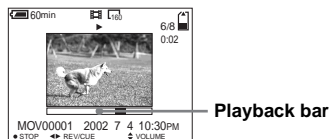

### To stop playback

Press the center .

### To adjust the volume

Press  .

### To rewind / fast-forward

Press   while playing back a movie.

To return to normal playback, press the center .

### High quality movies

Movies with the image size “320 (HQX)” appear on the full screen.

### Indicators on the screen while you are viewing movies

Each time you press DSPL/LCD ON/OFF, the status of the LCD screen changes as follows: Indicators OFF → LCD OFF → Indicators ON. See page 101 for a detailed description of the indicated items.

- The procedure for viewing movies on a TV is the same as that for viewing still images (page 34).



## Deleting movies

**Mode dial:** ►

You can delete unnecessary movies.

Control button

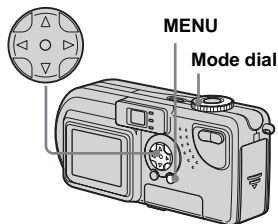

For the single screen

- 1** Set the mode dial to ►.
- 2** Select the movie you want to delete using ◀▶.
- 3** Press MENU.  
The menu appears.
- 4** Select [DELETE] using ◀▶, then press the center ●.  
The movie has not been deleted yet.
- 5** Select [OK] using ▲, then press the center ●.  
“MEMORY STICK ACCESS” appears on the screen.  
The movie has been deleted when the message disappears.

**To cancel the deletion**

In Step **5**, select [CANCEL].

For the Index (nine images) screen

- 1** Set the mode dial to ► and press the zoom W button once to display an Index (nine images) screen.
- 2** Press MENU.  
The menu appears.
- 3** Select [DELETE] using ◀▶, then press the center ●.
- 4** Select [SELECT] using ◀▶, then press the center ●.
- 5** Select the movies you want to delete using ▲▼/◀▶, then press the center ●.

A  mark is placed on the selected movie.



The movie has not been deleted yet.

**6 Repeat Step 5 of the procedure to delete other movies.**

**7 Press MENU.**

The menu appears.

**8 Select [OK] using ◀▶, then press the center ●.**

The movies are deleted when the “MEMORY STICK ACCESS” message disappears.

### To cancel the deletion

In Step 8, select [EXIT].

### To delete all the images

In Step 4, select [ALL], then press the center ●. To cancel the deletion, select [CANCEL] using ◀▶, then press the center ●.

*For the Index (three images) screen*

**1 Set the mode dial to ▶ and press the zoom W button twice to switch to the Index (three images) screen.**

**2 Move the movie you want to delete to the center using ◀▶.**

**3 Press MENU.**

The menu appears.

**4 Select [DELETE] using ▼, then press the center ●.**

The movie has not been deleted yet.

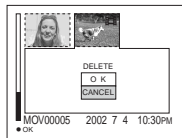

**5 Select [OK] using ▲, then press the center ●.**

The movie is deleted when the “MEMORY STICK ACCESS” message disappears.

### To cancel the deletion

In Step 5, select [CANCEL].

## Editing movies

### Mode dial:

You can cut movies, or delete unnecessary portions of movies. This is the recommended mode to use when the “Memory Stick” capacity is insufficient, or when you attach movies to your e-mail messages.

### The file numbers assigned when movies are cut

The files saved after a movie cut are recognized as the latest files and are assigned new numbers. The original files are deleted, and the numbers previously assigned to those files are treated as missing numbers.

<Example> Cutting a file numbered MOV00002.MPG

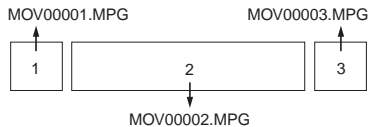

#### 1. Cutting scene A.



#### 2. Cutting scene B.

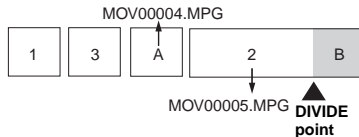

#### 3. Deleting scenes A and B if they are unnecessary.

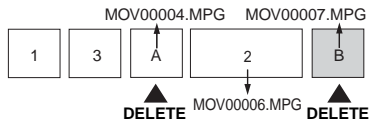







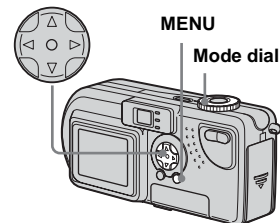

#### 4. Only the desired scenes remain.



## Cutting movies

### Control button



- 1** Set the mode dial to .
- 2** Select the movie you want to cut using /.
- 3** Press MENU.  
The menu appears.
- 4** Select [DIVIDE] using , then press the center . Next, select [OK] using , then press the center .

The playback of the movie starts.

## 5 Decide on a cutting point.

Press the center ● at the desired cutting point.

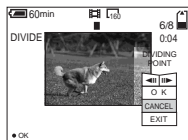

When you want to adjust the cutting point, use [◀/▶] (frame forward/rewind) and adjust the cutting point using ◀/ ▶. If you want to change the cutting point, select [CANCEL]. The playback of the movie starts again.

## 6 When you have decided on a cutting point, select [OK] using ▲/▼, and press the center ●.

## 7 Select [OK] using ▲, then press the center ●.

The movie is cut.

### To cancel cutting

In Step 5, select [EXIT]. The movie appears on the screen again.

- You cannot cut the following files.
  - Clip Motion files
  - Multi Burst files
  - Still image files
  - Files not long enough to cut
  - Protected MPEG movie files
- You cannot restore files once you cut them.
- The original file is deleted when you cut it.

### *Deleting unnecessary portions of movies*

## 1 Cut an unnecessary portion of a movie (see the previous page).

## 2 Display the portion of the movie you want to delete.

## 3 Press MENU.

The menu appears.

## 4 Select [DELETE] using ◀/ ▶, then press the center ●.

## 5 Select [OK] using ▲, then press the center ●.

The movie currently displayed on the screen is deleted.

---



## Copying movies to your computer

Follow the steps below to copy movies you shot to your computer.

### Before operation

Prepare the camera and your computer following the procedures described on pages 42 to 44.

*For Windows 98, 98SE, 2000, Me users*

- 1 Double-click  (My Computer), then double-click  (Removable Disk).**

The contents of the “Memory Stick” inserted into your camera appear.

- This section describes an example of copying movies into the “My Documents” folder.

- 2 Double-click  (MSSONY), then double-click  (MOML0001).**

The “MOML0001” folder opens.

- 3 Drag and drop the movie files into the “My Documents” folder.**

The movie files are copied to the “My Documents” folder.

*For Windows XP users*

For details, see pages 46 to 48.

- 1 Click [Copy pictures to a folder on my computer using Microsoft Scanner and Camera Wizard], then click [OK].**

The “Scanner and Camera Wizard” window appears.

- 2 Click [Next].**

The movies stored in the “Memory Stick” are displayed.

- 3 Click  to remove the checkmark from any movies you do not want to copy to your computer, then click [Next].**

The “Picture Name and Destination” window appears.

- 4 Specify the movie file names to be copied and the copy destination, then click [Next].**

Copying of the movies starts. When the task is completed, the “Other Options” window appears.

- Here the “My Documents” folder is used as a copy-to folder for explanation.

**5 Click [Nothing. I'm finished working with these pictures], then click [Next].**

The “Completing the Scanner and Camera Wizard” window appears.

**6 Click [Finish].**

The wizard closes.

- When you want to continue copying other movies, disconnect the USB cable once and reconnect it. Then, follow the process from Step **1**.

*For Macintosh users*

- 1** Double-click the newly recognized icon on the desktop.  
The contents of the “Memory Stick” inserted into your camera appear.
- 2** Double-click [MSSONY].
- 3** Double-click [MOML0001].
- 4** Drag and drop the movie files to the hard disk icon.  
The movie files are copied to your hard disk.

**To copy movie files using “ImageMixer”**

You can use the “PIXELA ImageMixer for Sony” software to copy movies to your computer. For details, see the software’s help files.

## Troubleshooting

If you have trouble with your camera, try the following solutions.

- 1 Check the items on pages 79 to 85. If the screen shows “C:□□:□□”, the self-diagnostics function is working. Please see page 87.

- 2 Press RESET (page 9) located inside the battery/“Memory Stick” cover, then turn on the power again. (This will erase the date/time settings, etc.)

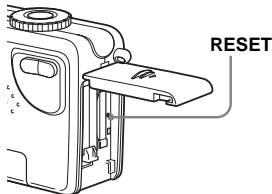

- 3 Consult your Sony dealer or local authorized Sony service facility.





### Battery and power

Symptom	Cause	Solution
The battery pack is not charged.	<ul style="list-style-type: none"><li>• The camera is turned on.</li></ul>	→ Turn the power off (page 15).
The battery pack cannot be installed.	<ul style="list-style-type: none"><li>• The battery pack is not properly installed.</li></ul>	→ Install the battery pack while pushing the battery eject lever down using the front edge of the battery pack (page 10).
¼/CHG lamp flashes.	<ul style="list-style-type: none"><li>• The battery pack is not properly installed.</li><li>• The battery pack malfunctions.</li></ul>	→ Properly install the battery pack (page 10). → Consult your Sony dealer or local authorized Sony service facility.
While charging the battery pack, the ¼/CHG lamp does not light.	<ul style="list-style-type: none"><li>• The AC power adaptor is not connected.</li><li>• The battery pack is not properly installed.</li><li>• The charging is complete.</li></ul>	→ Properly connect the AC power adaptor (page 10). → Properly install the battery pack (page 10). —
The battery remaining indicator is incorrect. Or the sufficient battery remaining indicator is displayed but the power soon runs out.	<ul style="list-style-type: none"><li>• You have used the camera for a long time in an extremely hot or an extremely cold location.</li><li>• The battery pack is dead (page 97).</li><li>• The battery pack is discharged.</li><li>• A mismatch has occurred in the remaining battery time information.</li></ul>	— → Replace the battery pack with a new one. → Replace it with a charged battery pack (page 10). → Fully charge the battery pack (page 10).











## Battery and power (continued)

Symptom	Cause	Solution
The battery pack runs down too quickly.	<ul style="list-style-type: none"> <li>You are recording/playing back images in an extremely cold location.</li> <li>The battery pack is not charged enough.</li> <li>The battery pack is dead (page 97).</li> </ul>	<p>—</p> <p>→ Fully charge the battery pack (page 10).</p> <p>→ Replace the battery pack with a new one.</p>
The power cannot be turned on.	<ul style="list-style-type: none"> <li>The battery pack is not installed properly.</li> <li>The AC power adaptor is disconnected.</li> </ul>	<p>→ Install the battery pack properly (page 10).</p> <p>→ Connect it securely to your camera (page 14).</p>
The power turns off suddenly.	<ul style="list-style-type: none"> <li>If you do not operate the camera for about 90 seconds while the power is on, the camera turns off automatically to prevent wearing down the battery (when [POWER SAVE] is [OFF], after three minutes.) (page 15).</li> <li>The battery pack is discharged.</li> </ul>	<p>→ Turn on the power again (page 15).</p> <p>→ Replace it with a charged battery pack (page 10).</p>

## Shooting still images / movies

Symptom	Cause	Solution
The LCD screen does not turn on when the power is turned on.	<ul style="list-style-type: none"> <li>The power was turned off with the LCD screen set to OFF the last time you used the camera.</li> </ul>	<p>→ Turn the LCD screen ON (page 28).</p>
The subject is not visible on the LCD screen.	<ul style="list-style-type: none"> <li>The mode dial is not set to , SCN, or .</li> </ul>	<p>→ Set it to , SCN, or  (pages 22, 30, 71).</p>
The image is out of focus.	<ul style="list-style-type: none"> <li>The subject is too close.</li> <li>Scene selection is set to the Landscape mode.</li> <li>Focus preset is selected.</li> </ul>	<p>→ Set the macro recording mode when you shoot a subject that is within 50 cm (19 <sup>11</sup>/<sub>16</sub> inches) from the lens. Make sure to place the lens farther away from the subject than the shortest shooting distance when shooting (page 24).</p> <p>→ Cancel the setting (page 30).</p> <p>→ Set to the auto focus mode (page 55).</p>
Unable to zoom.	<ul style="list-style-type: none"> <li>You cannot zoom while shooting a movie (MPEG movie).</li> </ul>	<p>—</p>





Symptom	Cause	Solution
<b>Digital zoom does not function.</b>	<ul style="list-style-type: none"> <li>You cannot zoom while shooting a movie (MPEG movie).</li> <li>[DIGITAL ZOOM] is set to [OFF] in the SET UP setting.</li> <li>The LCD screen is OFF.</li> </ul>	— → Set it to [ON] (pages 52, 93). → Turn it ON (page 28).
<b>The image is too dark.</b>	<ul style="list-style-type: none"> <li>You are shooting a subject with a light source behind the subject.</li> <li>The brightness of the LCD screen is too low.</li> <li>[POWER SAVE] is set to [ON].</li> </ul>	→ Adjust the exposure (page 55). → Adjust the brightness of the LCD screen (pages 52, 94). → Set [POWER SAVE] to [OFF] (pages 52, 94).
<b>The image is too bright.</b>	<ul style="list-style-type: none"> <li>You are shooting under a spotlight in a dark location, like stage lighting.</li> <li>The LCD screen is too bright.</li> </ul>	→ Adjust the exposure (page 55). → Adjust the brightness of the LCD screen (pages 52, 94).
<b>The image is monochrome (black and white).</b>	<ul style="list-style-type: none"> <li>[PFX] (P. EFFECT) is set to [B&amp;W].</li> </ul>	→ Cancel the B&W mode (page 62).
<b>Vertical streaks appear when you are shooting a very bright subject.</b>	<ul style="list-style-type: none"> <li>The smear phenomenon is occurring.</li> </ul>	→ This is not a malfunction.
<b>You cannot shoot images.</b>	<ul style="list-style-type: none"> <li>No “Memory Stick” is inserted.</li> <li>The capacity of the “Memory Stick” is insufficient.</li> <li>The write-protect switch on the “Memory Stick” is set to the LOCK position.</li> <li>You cannot shoot while the flash is charging.</li> <li>The mode dial is not set to  or SCN while shooting a still image.</li> <li>The mode dial is not set to  when shooting a movie.</li> </ul>	→ Insert a “Memory Stick” (page 18). → Delete the images saved in the “Memory Stick,” or format it. → Change the “Memory Stick.” → Set it to the recording position (page 96). — → Set it to  or SCN (pages 22, 30). → Set it to  (page 71).
<b>Cannot shoot images with the flash.</b>	<ul style="list-style-type: none"> <li>The mode dial is set to , SET UP, or .</li> <li>The flash is set to  (No flash).</li> <li>When shooting still images, Scene selection is set to the Twilight mode.</li> </ul>	→ Set it to a setting other than  , SET UP, or  (page 26). → Set the flash to “Auto” (no indicator) or  (forced flash) (page 26). → Cancel the Twilight mode (page 30).

## Shooting still images/ movies (continued)

Symptom	Cause	Solution
The eyes of the subject come out red.	—	→ Set the red eye reduction mode (page 27).
The date and time are recorded incorrectly.	<ul style="list-style-type: none"><li>• The date and time are not set correctly.</li></ul>	→ Set the correct date and time (page 16).

## Viewing images

Symptom	Cause	Solution
The image cannot be played back.	<ul style="list-style-type: none"><li>• The mode dial is not set to .</li><li>• You cannot play back the image on your camera, if it is modified on a computer or its file name is changed.</li></ul>	→ Set the mode dial to  (page 32). —
Images are coarse right after being played back.	—	→ This is not a malfunction.
The images cannot be played back on a TV.	<ul style="list-style-type: none"><li>• The [VIDEO OUT] setting for your camera in SET UP is incorrect.</li><li>• The connection is not correct.</li></ul>	→ Set it to [NTSC] or [PAL] (pages 52, 94). → Check the connection (page 34).
The images cannot be played back on a computer.	—	→ See page 83.
Unknown beeps are heard from the camera while viewing a movie.	<ul style="list-style-type: none"><li>• These beeps are heard when the auto focus is working.</li></ul>	→ This is not a malfunction. Set to the focus preset mode (page 55).

## Deleting/editing an image

Symptom	Cause	Solution
Your camera cannot delete an image.	<ul style="list-style-type: none"><li>• The image is protected.</li><li>• The write-protect switch on the “Memory Stick” is set to the LOCK position.</li></ul>	→ Cancel the protection (page 66). → Set it to the recording position (page 96).

Symptom	Cause	Solution
<b>You have deleted the image by mistake.</b>	<ul style="list-style-type: none"> <li>Once you have deleted a file, you cannot restore it.</li> </ul>	→ The write-protect switch on the “Memory Stick” will prevent you from deleting images by mistake (page 96).
<b>The resizing function does not work.</b>	<ul style="list-style-type: none"> <li>Movie (MPEG movie)/Clip Motion/Multi Burst files cannot be resized.</li> </ul>	—
<b>You cannot display a print mark.</b>	<ul style="list-style-type: none"> <li>Print marks cannot be attached to movie (MPEG movie)/Clip Motion files.</li> </ul>	—

## Computers

Symptom	Cause	Solution
<b>You do not know whether or not your OS can be used with the camera.</b>	—	→ Check “Recommended computer environment” (page 41).
<b>You cannot install the USB driver.</b>	—	→ In Windows 2000, log on as Administrator (authorized Administrators) (page 42).
<b>Your computer does not recognize your camera.</b>	<ul style="list-style-type: none"> <li>The camera is turned off.</li> <li>The battery level is too low.</li> <li>You are not using the supplied USB cable.</li> <li>The USB cable is not connected securely.</li> </ul> <ul style="list-style-type: none"> <li>[USB CONNECT] is set to [PTP] in the SET UP settings.</li> <li>The USB connectors on your computer are connected to other equipment besides the keyboard, the mouse, and your camera.</li> <li>The USB driver is not installed.</li> <li>Your computer does not properly recognize the device because you connected the camera and your computer with the USB cable before you installed the “USB Driver” from the supplied CD-ROM.</li> </ul>	<ul style="list-style-type: none"> <li>→ Turn on the camera (page 15).</li> <li>→ Use the AC power adaptor (supplied) (page 14).</li> <li>→ Use the supplied USB cable (page 44).</li> <li>→ Disconnect the USB cable, and securely connect it again. Make sure that “USB MODE” is displayed on the LCD screen (page 44).</li> <li>→ Set it to [NORMAL] (pages 52, 94).</li> </ul> <ul style="list-style-type: none"> <li>→ Disconnect the USB cables except for those connected to the keyboard, the mouse, and your camera.</li> </ul> <ul style="list-style-type: none"> <li>→ Install the USB driver (page 42).</li> <li>→ Delete the erroneously recognized device from your computer, then install the USB driver (pages 42, 46).</li> </ul>

## Computers (continued)

Symptom	Cause	Solution
<b>You cannot copy images.</b>	<ul style="list-style-type: none"><li>• The camera is not correctly connected to your computer.</li><li>• The copy procedure differs depending on your OS.</li><li>—</li></ul>	<ul style="list-style-type: none"><li>→ Connect the camera and your computer correctly using the USB cable (See above).</li><li>→ Follow the copy procedure that your OS suggests (pages 45, 46, 51).</li><li>→ If you are using the “PIXELA ImageMixer for Sony” software, click on HELP.</li></ul>
<b>The image cannot be played back on a computer.</b>	— —	<ul style="list-style-type: none"><li>→ If you are using the “PIXELA ImageMixer for Sony” software, click on HELP.</li><li>→ Consult the computer or software manufacturer.</li></ul>
<b>The image and sound are affected by noise when you play back an image on a computer.</b>	<ul style="list-style-type: none"><li>• You are playing back the file directly from the “Memory Stick.”</li></ul>	<ul style="list-style-type: none"><li>→ Copy the file to the hard disk of the computer and then play the file back from the hard disk (page 77).</li></ul>
<b>You cannot print an image.</b>	—	<ul style="list-style-type: none"><li>→ Check the printer settings.</li><li>→ See “Choosing images to print” (page 69), or if you are using the “PIXELA ImageMixer for Sony” software, click on HELP.</li></ul>

## “Memory Stick”



Symptom	Cause	Solution
<b>You cannot insert a “Memory Stick.”</b>	<ul style="list-style-type: none"><li>• You are inserting it backwards.</li></ul>	<ul style="list-style-type: none"><li>→ Insert it from the right side (page 18).</li></ul>
<b>You cannot record on a “Memory Stick.”</b>	<ul style="list-style-type: none"><li>• The write-protect switch on the “Memory Stick” is set to the LOCK position.</li><li>• The “Memory Stick” is full.</li></ul>	<ul style="list-style-type: none"><li>→ Set it to the recording position (page 96).</li><li>→ Delete unnecessary images (pages 36, 73).</li></ul>
<b>You cannot format a “Memory Stick.”</b>	<ul style="list-style-type: none"><li>• The write-protect switch on the “Memory Stick” is set to the LOCK position.</li></ul>	<ul style="list-style-type: none"><li>→ Set it to the recording position (page 96).</li></ul>
<b>You have formatted a “Memory Stick” by mistake.</b>	<ul style="list-style-type: none"><li>• All the images on the “Memory Stick” are deleted by formatting.</li></ul>	<ul style="list-style-type: none"><li>→ We recommend that you set the “Memory Stick” write-protect switch to the LOCK position to protect accidental erasure (page 96).</li></ul>

## Others

Symptom	Cause	Solution
<b>The camera does not work, no operations can be performed.</b>	<ul style="list-style-type: none"> <li>• An “InfoLITHIUM” battery is not used.</li> <li>• The battery level is low or zero (The  indicator appears.).</li> <li>• The AC power adaptor is not connected securely.</li> <li>• The internal system is not working properly.</li> </ul>	→ Use an “InfoLITHIUM” battery only (page 96). → Charge the battery (page 10).  → Connect it securely to the DC IN jack of your camera and to a wall outlet (wall socket) (page 14). → Disconnect, and then, after one minute, reconnect all power sources. Then turn the power on and check that the camera works properly.
<b>The power is on, but the camera does not work.</b>	<ul style="list-style-type: none"> <li>• The internal system is not working properly.</li> </ul>	→ Remove, and then, after one minute, reinstall the battery. If this does not work, press the RESET button located inside the battery/“Memory Stick” cover with a pointed object, then turn the power on again. (This will clear the date/time settings, etc.)
<b>You cannot identify the indicator on the LCD screen.</b>	—	→ Check the indicator (pages 99 to 101).
<b>The lens does not move back when you turn off the camera.</b>	<ul style="list-style-type: none"> <li>• The battery pack is discharged.</li> </ul>	→ Replace it with a fully charged battery or use the AC power adaptor (pages 10, 14).
<b>The lens gets fogged.</b>	<ul style="list-style-type: none"> <li>• Condensation is occurring.</li> </ul>	→ Leave the camera for about an hour and then try to use it again (page 95).
<b>The camera gets hot if you use it for a long time.</b>	—	→ This is not a malfunction.

## Warnings and messages

The following messages appear on the LCD screen.

Message	Meaning/ Corrective Action
<b>NO MEMORY STICK</b>	<ul style="list-style-type: none"><li>• Insert a “Memory Stick” (page 18).</li></ul>
<b>SYSTEM ERROR</b>	<ul style="list-style-type: none"><li>• Turn the power off and on again (page 15).</li></ul>
<b>MEMORY STICK ERROR</b>	<ul style="list-style-type: none"><li>• The inserted “Memory Stick” cannot be used in your camera (page 96).</li><li>• The “Memory Stick” is damaged, or the terminal section of the “Memory Stick” is dirty.</li><li>• Insert the “Memory Stick” correctly (page 18).</li></ul>
<b>FORMAT ERROR</b>	<ul style="list-style-type: none"><li>• The “Memory Stick” format failed. Format the “Memory Stick” again (page 40).</li></ul>
<b>MEMORY STICK LOCKED</b>	<ul style="list-style-type: none"><li>• The write-protect switch on the “Memory Stick” is set to the LOCK position. Set it to the recording position (page 96).</li></ul>
<b>NO MEMORY SPACE</b>	<ul style="list-style-type: none"><li>• The capacity of the “Memory Stick” is insufficient. You cannot record images. Delete unnecessary images (pages 36, 73).</li></ul>
<b>NO FILE</b>	<ul style="list-style-type: none"><li>• No images have been recorded on the “Memory Stick.”</li></ul>
<b>FILE ERROR</b>	<ul style="list-style-type: none"><li>• An error occurred while playing back the image.</li></ul>
<b>FILE PROTECT</b>	<ul style="list-style-type: none"><li>• The image is protected against erasure.</li></ul>
<b>For "InfoLITHIUM" BATTERY ONLY</b>	<ul style="list-style-type: none"><li>• The battery is not the “InfoLITHIUM” type.</li></ul>
<b>FOLDER ERROR</b>	<ul style="list-style-type: none"><li>• A folder with the same name already exists on the “Memory Stick.”</li></ul>
<b>IMAGE SIZE OVER</b>	<ul style="list-style-type: none"><li>• You are playing back an image of a size that cannot be played back on your camera.</li></ul>
<b>INVALID OPERATION</b>	<ul style="list-style-type: none"><li>• You are playing back a file that was created on equipment other than this camera.</li></ul>
	<ul style="list-style-type: none"><li>• The battery level is low or zero. Charge the battery (page 10). Depending on the conditions of use or the type of battery pack, the indicator may flash even though there are still 5 to 10 minutes of remaining battery time left.</li></ul>
<b>CAN NOT DIVIDE</b>	<ul style="list-style-type: none"><li>• The file is not long enough to be divided.</li><li>• The file is not a movie (MPEG movie).</li></ul>
	<ul style="list-style-type: none"><li>• You are not holding the camera steadily enough. Use the flash, mount the camera on a tripod, or otherwise secure the camera in place.</li></ul>
<b>TURN THE POWER OFF AND ON AGAIN</b>	<ul style="list-style-type: none"><li>• A problem with the lens caused an error.</li></ul>

## Self-diagnostics display

Your camera has a self-diagnostics display. This function displays the condition of the camera on the LCD screen using a combination of a letter and four numerical digits. If this occurs, check the following code chart and take the corresponding countermeasure. The last two digits (indicated by □□) will differ depending on the state of the camera.

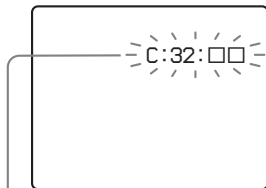

Self-diagnostics display

Code	Cause	Countermeasure
<b>C:32:</b> □□	There is trouble with your camera's hardware, or with the zoom function.	<ul style="list-style-type: none"><li>• Turn the power off and on again (page 15).</li></ul>
<b>C:13:</b> □□	The camera cannot read or write data on the "Memory Stick."	<ul style="list-style-type: none"><li>• Re-insert the "Memory Stick" several times.</li></ul>
	An unformatted "Memory Stick" is inserted.	<ul style="list-style-type: none"><li>• Format the "Memory Stick" (page 40).</li></ul>
	The inserted "Memory Stick" cannot be used with your camera, or the data is damaged.	<ul style="list-style-type: none"><li>• Insert a new "Memory Stick" (page 18).</li></ul>
<b>E:61:</b> □□ <b>E:91:</b> □□	A camera malfunction has occurred.	<ul style="list-style-type: none"><li>• Press the RESET button (page 9) located inside the battery/"Memory Stick" cover, then turn the power on again.</li></ul>

If your camera is not still functioning well after trying the countermeasure a couple of times, contact your Sony dealer or local authorized Sony service facility and inform them of the 5-digit code.

Example: E:61:10

## *The number of images that can be saved/shooting time*

The number of images that can be saved and the shooting time are different, depending on the capacity of the “Memory Stick,” the image size, and the image quality. Refer to the following charts when you choose a “Memory Stick.”

- The number of images is listed in FINE (STANDARD) order.
- The values for the number of images that can be saved and the shooting time may vary, depending on the shooting conditions.
- For normal shooting times and numbers of images that can be saved, see page 21.

### Clip Motion

(Units: images)

	8M	16M	32M	64M	128M
NORMAL	40	80	160	320	640
MOBILE	300	450	900	1800	3600

NORMAL: When 10 frames are shot

MOBILE: When two frames are shot

### Multi Burst

(Units: images)

	8M	16M	32M	64M	128M
1280×960	12 (23)	24 (44)	50 (93)	100 (186)	202 (375)

### E-mail

(Units: images)

	8M	16M	32M	64M	128M
2272×1704 (DSC-P9)	3 (7)	7 (14)	16 (29)	32 (58)	64 (116)
2272 (3:2) (DSC-P9)	3 (7)	7 (14)	16 (29)	32 (58)	64 (116)
2048×1536 (DSC-P7)	4 (8)	9 (17)	20 (36)	40 (72)	81 (146)
2048 (3:2) (DSC-P7)	4 (8)	9 (17)	20 (36)	40 (72)	81 (146)
1600×1200	8 (14)	16 (28)	32 (59)	64 (118)	128 (236)
1280×960	12 (21)	24 (42)	48 (88)	96 (176)	192 (352)
640×480	43 (95)	87 (192)	177 (390)	357 (786)	714 (1572)

### VOICE

(Units: images)

	8M	16M	32M	64M	128M
2272×1704 (DSC-P9)	3 (7)	7 (13)	15 (28)	30 (56)	60 (112)
2272 (3:2) (DSC-P9)	3 (7)	7 (13)	15 (28)	30 (56)	60 (112)
2048×1536 (DSC-P7)	4 (8)	9 (16)	19 (34)	39 (69)	78 (138)
2048 (3:2) (DSC-P7)	4 (8)	9 (16)	19 (34)	39 (69)	78 (138)
1600×1200	7 (13)	14 (26)	31 (54)	62 (108)	124 (216)
1280×960	11 (19)	22 (38)	45 (78)	90 (156)	180 (312)
640×480	34 (56)	68 (120)	139 (244)	280 (491)	560 (982)

### MPEG movies

(Units: seconds)















	8M	16M	32M	64M	128M
320 (HQX)	20	40	85	170	340
320×240	80	160	340	680	1360
160×112	320	640	1300	2700	5400





## Menu items

Menu items that can be changed differ depending on the position of the mode dial. The LCD screen shows only the items you can operate based on the current position of the mode dial. Factory settings are indicated with ■.









### When the mode dial is set to or SCN

Item	Setting	Description
SCN	■  /  / 	Selects one of the Scene selections (When the mode dial is set to  , this setting cannot be carried out.) (page 30).
 (EV)	+2.0EV / +1.7EV / +1.3EV / +1.0EV / +0.7EV / +0.3EV / ■0EV / -0.3EV / -0.7EV / -1.0EV / -1.3EV / -1.7EV / -2.0EV	Adjusts the exposure (page 55).
 (FOCUS)	∞ / 7.0m / 3.0m / 1.0m / 0.5m / CENTER AF / ■ MULTI AF	Chooses the auto focus method (page 53), sets the focus preset distance (page 55).
WB (WHITE BAL)	 /  /  /  / ■ AUTO	Sets the white balance (page 57).
 (SPOT METER)	ON / ■ OFF	Matches the exposure to the subject you want to shoot (page 56).
ISO	400 / 200 / 100 / ■ AUTO	Selects the ISO sensitivity. When shooting under dark conditions or shooting a fast-moving subject, use a high-number setting. When recording high-quality images, use a low-number setting (When the mode dial is set to SCN, this setting cannot be carried out.).
 (IMAGE SIZE) (DSC-P9)	■ 2272×1704 / 2272 (3:2) / 1600×1200 / 1280×960 / 640×480	Selects the image size used when shooting still images (page 19).
 (IMAGE SIZE) (DSC-P7)	■ 2048×1536 / 2048 (3:2) / 1600×1200 / 1280×960 / 640×480	Selects the image size used when shooting still images (page 19).
 (P.QUALITY)	■ FINE / STANDARD	Records images with fine image quality mode. / Records images in the standard image quality mode (page 19).

















### When the mode dial is set to or SCN (continued)

Item	Setting	Description
<b>MODE (REC MODE)</b>	VOICE E-MAIL  ■NORMAL	<ul style="list-style-type: none"> <li>– Records an audio file (with a still image) in addition to the JPEG file (page 61).</li> <li>– Records a small-size (320×240) JPEG file in addition to the selected image size (page 61).</li> <li>– Records an image using the normal recording mode.</li> </ul>
<b>± (FLASH LEVEL)</b>	HIGH ■NORMAL LOW	<ul style="list-style-type: none"> <li>– Makes the flash level higher than normal.</li> <li>– Normal setting.</li> <li>– Makes the flash level lower than normal.</li> </ul>
<b>PFX (P.EFFECT)</b>	SOLARIZE / B&W / SEPIA / NEG.ART / ■OFF	Sets the special effects for the image (page 62).
<b> (SHARPNESS)</b>	+2 / +1 / ■0 / -1 / -2	Adjusts the sharpness of the image. The  indicator appears (except when the setting is 0).









### When the mode dial is set to (when [MOVING IMAGE] is set to [MPEG MOVIE] in the SET UP settings)

Item	Setting	Description
<b> (EV)</b>	+2.0EV / +1.7EV / +1.3EV / +1.0EV / +0.7EV / +0.3EV / ■0EV / -0.3EV / -0.7EV / -1.0EV / -1.3EV / -1.7EV / -2.0EV	Adjusts the exposure (page 55).
<b> (FOCUS)</b>	∞ / 7.0m / 3.0m / 1.0m / 0.5m / CENTER AF / ■MULTI AF	Chooses the auto focus method (page 53), sets the focus preset distance (page 55).
<b>WB (WHITE BAL)</b>	 /  /  /  / ■AUTO	Sets the white balance (page 57).
<b> (SPOT METER)</b>	ON / ■OFF	Matches the exposure to the subject you want to shoot (page 56).
<b> (IMAGE SIZE)</b>	320 (HQX) / 320×240 / ■160×112	Selects the MPEG image size when recording movies (page 71).
<b>PFX (P.EFFECT)</b>	SOLARIZE / B&W / SEPIA / NEG.ART / ■OFF	Sets the special effects for the image (page 62).









When the mode dial is set to  (when [MOVING IMAGE] is set to [CLIP MOTION] in the SET UP settings)

Item	Setting	Description
 (EV)	+2.0EV / +1.7EV / +1.3EV / +1.0EV / +0.7EV / +0.3EV /  / -0.3EV / -0.7EV / -1.0EV / -1.3EV / -1.7EV / -2.0EV	Adjusts the exposure (page 55).
 (FOCUS)	$\infty$ / 7.0m / 3.0m / 1.0m / 0.5m / CENTER AF / 	Chooses the auto focus method (page 53), sets the focus preset distance (page 55).
WB (WHITE BAL)	 / 	Sets the white balance (page 57).
 (SPOT METER)	ON / 	Matches the exposure to the subject you want to shoot (page 56).
 (IMAGE SIZE)	 NORMAL / MOBILE	Selects the Clip Motion image size (page 58).
 (FLASH LEVEL)	HIGH  NORMAL LOW	<ul style="list-style-type: none"> <li>- Makes the flash level higher than normal.</li> <li>- Normal setting.</li> <li>- Makes the flash level lower than normal.</li> </ul>
PFX (P.EFFECT)	SOLARIZE / B&W / SEPIA / NEG.ART / 	Sets the special effects for the image (page 62).
 (SHARPNESS)	+2 / +1 /  0 / -1 / -2	Adjusts the sharpness of the image. The  indicator appears (except when the setting is 0).





When the mode dial is set to  (when [MOVING IMAGE] is set to [MULTI BURST] in the SET UP settings)

Item	Setting	Description
 (EV)	+2.0EV / +1.7EV / +1.3EV / +1.0EV / +0.7EV / +0.3EV /  / -0.3EV / -0.7EV / -1.0EV / -1.3EV / -1.7EV / -2.0EV	Adjusts the exposure (page 55).
 (FOCUS)	$\infty$ / 7.0m / 3.0m / 1.0m / 0.5m / CENTER AF / 	Chooses the auto focus method (page 53), sets the focus preset distance (page 55).
WB (WHITE BAL)	 / 	Sets the white balance (page 57).
 (SPOT METER)	ON / 	Matches the exposure to the subject you want to shoot (page 56).

## When the mode dial is set to (when [MOVING IMAGE] is set to [MULTI BURST] in the SET UP settings) (continued)

Item	Setting	Description
 (INTERVAL)	1/7.5 / 1/15 /  1/30 (NTSC) 1/6.3 / 1/12.5 /  1/25 (PAL)	<ul style="list-style-type: none"> <li>– In NTSC mode, choose the Multi Burst between-frame shutter interval.</li> <li>– In PAL mode, choose the Multi Burst between-frame shutter interval.</li> <li>* The choices of between-frame shutter interval change depending on the setting of the [VIDEO OUT] item in SET UP (page 94).</li> </ul>
 (P.QUALITY)	 FINE / STANDARD	Records images with fine image quality mode. / Records images in the standard image quality mode (page 19).
PFX (P.EFFECT)	SOLARIZE / B&W / SEPIA / NEG.ART /  OFF	Sets the special effects for the image (page 62).
 (SHARPNESS)	+2 / +1 /  0 / -1 / -2	Adjusts the sharpness of the image. The  indicator appears (except when the setting is 0).

## When the mode dial is set to

Item	Setting	Description
DELETE	OK CANCEL	<ul style="list-style-type: none"> <li>– Deletes the displayed image (pages 36, 73).</li> <li>– Cancels deleting of the image.</li> </ul>
PROTECT	—	Protects images against accidental erasure (page 66).
PRINT	—	Selects still images you want to print (page 69).
SLIDE	INTERVAL  REPEAT START CANCEL	<ul style="list-style-type: none"> <li>– Sets the slide show interval. (For the single screen only.)  3 sec / 5 sec / 10 sec / 30 sec / 1 min</li> <li>– Repeats the slide show.  ON/OFF</li> <li>– Starts the slide show</li> <li>– Cancels the settings and execution of the slide show</li> </ul>
RESIZE	2272×1704 (DSC-P9 only) / 2048×1536 (DSC-P7 only) / 1600×1200 / 1280×960 / 640×480 / CANCEL	Changes the recorded image size (page 68). (For single images only.)
ROTATE	 (counter-clockwise) /  (clockwise) / OK / CANCEL	Rotates the still image (page 65). (For single images only.)
DIVIDE	OK / CANCEL	Divides a movie (page 75). (For single images only.)

## SET UP items

Set the mode dial to SET UP. The SET UP screen appears.

Factory settings are indicated with ■.

When shooting movies, or images recorded in Clip Motion/Multi Burst modes, the date and time cannot be inserted in the image. Also, the date and time will not be displayed when shooting. The date and time will be displayed when the image is played back.

### CAMERA

Item	Setting	Description
<b>MOVING IMAGE</b>	■MPEG MOVIE / CLIP MOTION / MULTI BURST	Selects the shooting mode (pages 52, 58, 59, 71).
<b>DATE/TIME</b>	DAY & TIME / DATE / ■OFF	Selects whether to insert the date and time into the image (page 29).
<b>DIGITAL ZOOM</b>	■ON / OFF	Selects whether to use the digital zoom (page 24).
<b>RED EYE REDUCTION</b>	ON / ■OFF	Reduces the red-eye phenomenon when using a flash (page 27).
<b>AF ILLUMINATOR</b>	■AUTO / OFF	Selects whether to emit an AF assist light in the dark. Helps when it is hard to focus on the subject under dark lighting (page 27).

### SETUP 1

Item	Setting	Description
<b>FORMAT</b>	OK / CANCEL	Formats the “Memory Stick.” Please note that formatting erases all the information recorded on a “Memory Stick,” including even erasure protected images (page 40).
<b>FILE NUMBER</b>	■ SERIES RESET	– Assigns numbers to files in sequence even if the “Memory Stick” is changed. – Resets the file numbering and starts from 0001 each time the “Memory Stick” is changed.
<b>言語 / LANGUAGE</b>	■ ENGLISH 日本語 / JPN	– Displays the menu items, warnings and messages in English. – Displays the menu items, warnings and messages in Japanese.
<b>CLOCK SET</b>	OK / CANCEL	Sets the date and time (page 16).

**SETUP 2**

Item	Setting	Description
<b>LCD BRIGHTNESS</b>	BRIGHT/ ■NORMAL/ DARK	Selects the LCD brightness. This has no effect on the recorded images.
<b>LCD BACKLIGHT</b>	BRIGHT/ ■NORMAL	Selects the brightness of the LCD backlight. Selecting [BRIGHT] makes the screen bright and easy to see when using the camera outdoors or in other bright locations, but also uses up the battery charge faster. Displayed only when you are using your camera with the battery pack. When [POWER SAVE] is set to [ON], this item cannot be set.
<b>BEEP</b>	SHUTTER ■ ON OFF	<ul style="list-style-type: none"><li>– Turns on the shutter sound when you release the shutter.</li><li>– Turns on the beep/shutter sound when you press the control button/ release the shutter.</li><li>– Turns off the beep/shutter sound.</li></ul>
<b>VIDEO OUT</b>	NTSC PAL	<ul style="list-style-type: none"><li>– Sets the video output signal to NTSC mode (Japan, USA).</li><li>– Sets the video output signal to PAL mode (Europe).</li></ul>
<b>USB CONNECT</b>	PTP/■NORMAL	Switches the USB mode (page 41).
<b>POWER SAVE</b>	■ ON / OFF	Selects whether to use the POWER SAVE mode (page 13). Displayed only when you are using your camera with the battery pack.

---

## Precautions

### Cleaning

#### Cleaning the LCD screen

Clean the screen surface with an LCD cleaning kit (not supplied) to remove fingerprints, dust, etc.

#### Cleaning the lens

Wipe the lens with a soft cloth to remove fingerprints, dust, etc.

#### Cleaning the DC plug

Clean the DC plug of the AC power adaptor with a dry cotton bud. Do not use the dirty plug. Use of the dirty plug may not properly charge the battery pack.

#### Cleaning the camera surface

Clean the camera surface with a soft cloth slightly moistened with water, then wipe the surface with a dry cloth. Do not use any type of solvent such as thinner, alcohol or benzine as this may damage the finish or the casing.

#### Note on operating temperature

The camera is designed for use within a temperature range of 0° to 40° (32°F to 104°F). Shooting in extremely cold or hot locations that exceed this range is not recommended.

### On moisture condensation

If the camera is brought directly from a cold to a warm location, or is placed in a very damp room, moisture may condense inside or outside the camera. This moisture condensation may cause a malfunction of the camera.

#### Moisture condensation occurs easily when:

- The camera is brought from a cold location such as a ski slope into a warmly heated room.
- The camera is taken from an air-conditioned room or car interior to the hot outdoors, etc.

#### To prevent moisture condensation

When bringing the camera from a cold place to a warm place, seal the camera in a plastic bag and leave it in the new location for about an hour. Remove the plastic bag when the camera has adapted to the new temperature.

#### If moisture condensation occurs

Turn off the camera and wait about an hour for the moisture to evaporate. Note that if you attempt to shoot with moisture remaining inside the lens, you will be unable to record clear images.

### The internal rechargeable button battery

This camera has an internal rechargeable button battery for maintaining the date and time and other settings regardless of whether the power is on or off.

This rechargeable button battery is continually charged as long as you are using the camera. However, if you use the camera for only short periods it discharges gradually, and if you do not use the camera at all for about one month it becomes completely discharged. In this case, be sure to charge this rechargeable button battery before using the camera.

Note that even if this rechargeable button battery is not charged, you can still use the camera as long as you do not record the date and time.

#### Charging the battery

Connect the camera to a wall outlet (wall socket) using the AC power adapter or install a charged battery pack, and leave the camera for 24 hours or more with the POWER button set to OFF.

## The “Memory Stick”

“Memory Stick” is a new compact, portable and versatile IC recording medium with a data capacity that exceeds the capacity of a floppy disk.

There are two types of “Memory Stick”: an ordinary “Memory Stick” and a “MagicGate Memory Stick” that are equipped with the MagicGate copyright protection technology. You can use both types of “Memory Stick” with your camera. However, because your camera does not support the MagicGate standards, data recorded with your camera is not subject to MagicGate\* copyright protection.

\* MagicGate is copyright protection technology that uses encryption technology.

- You cannot record or delete images when the write-protect switch is set to LOCK. The position or the shape of the write-protect switch may differ depending on the “Memory Stick” you use.

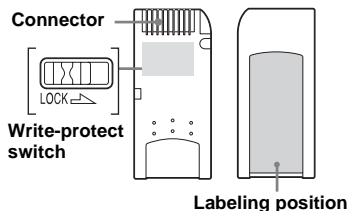

- Do not remove the “Memory Stick” while reading or writing data.
- Data may be damaged in a location subject to the effects of static electricity or noise.
- Do not attach any other material than the supplied label on the labeling position.
- When you carry or store the “Memory Stick,” put it in the case supplied with it.
- Do not touch the terminals of a “Memory Stick” with your hand or a metal object.
- Do not strike, bend or drop a “Memory Stick.”
- Do not disassemble or modify a “Memory Stick.”
- Do not expose the “Memory Stick” to water.

## The “InfoLITHIUM” battery pack



### What is the “InfoLITHIUM” battery pack?

The “InfoLITHIUM” battery pack is a lithium-ion battery pack that has functions for communicating information related to operating conditions of your camera. The “InfoLITHIUM” battery pack calculates the power consumption according to the operating conditions of your camera, and displays the remaining battery time in minutes.

### Charging the battery pack

- We recommend charging the battery pack in an ambient temperature of between 10°C to 30°C (50°F to 86°F). If you charge the battery pack outside of this temperature range, you may not be able to efficiently charge the battery pack.
- We recommend fully charging the battery pack.



## Effective use of the battery

- Battery performance decreases in low-temperature surroundings, and the battery life is shortened under such circumstances. To use the battery pack longer, we recommend you keep the battery pack in a pocket close to your body to warm it, and insert it in your camera just before you start shooting.
- If you use the LCD screen or shoot a lot using the zoom or flash, the battery power will be used up faster.
- We recommend having spare batteries handy for two or three times the expected shooting time, and try test shooting before the actually using the camera.
- Do not expose the battery pack to water. The battery pack is not water-resistant.

## Remaining battery time indicator

If the power goes off although the battery remaining indicator indicates that the battery pack has enough power to operate, charge the battery pack fully again after running it down so that the indication on the battery remaining indicator is correct. Note, however, that the correct battery indication sometimes will not be restored if it is used in high temperatures for a long time or left in a fully charged state, or the battery pack is frequently used.

## How to store the battery pack

- If the battery pack is not to be used for a long time, do the following procedure once per year to maintain proper function.
  1. Fully charge the battery pack.
  2. Discharge on your camera.
  3. Remove the battery from your camera and store it in a dry, cool place.
- To use the battery pack up on your camera, leave the POWER button to on in slide show playback mode (page 64) until the power goes off.

## Battery life

- The battery life is limited. Battery capacity decreases little by little as you use it more and more, and as time passes. When the battery operating time seems to have been considerably shortened, a probable cause is that the battery pack has reached the end of its life.
- The battery life varies depending on storage, operating conditions, and environment, and is different for each battery pack.

## Specifications

### System

Image device **DSC-P9**  
8.98 mm (1/1.8 type) color  
CCD  
Primary color filter  
**DSC-P7**  
8.93 mm (1/1.8 type) color  
CCD  
Primary color filter

Total pixels number of camera  
**DSC-P9**  
Approx. 4 130 000 pixels  
**DSC-P7**  
Approx. 3 340 000 pixels

Lens 3× zoom lens  
f=8–24.0 mm ( $\frac{5}{16}$ – $\frac{15}{16}$  inches)  
(35 mm camera conversion: 39 to  
117mm (1  $\frac{17}{32}$ –4  $\frac{19}{32}$  inches))  
F2.8–5.6

### Camera

Effective pixels number of camera  
**DSC-P9**  
Approx. 3 950 000 pixels  
**DSC-P7**  
Approx. 3 210 000 pixels

Exposure control  
Automatic,  
Scene selection (three modes)

White balance  
Automatic, Daylight, Cloudy,  
Fluorescent, Incandescent

File format	Still images: DCF conformity (Exif Ver. 2.2, JPEG conformity GIF at Clip Motion) DPOF correspondence Movies: MPEG1 conformity (Monaural) Audio with still image: MPEG1 conformity (Monaural)
Recording media	“Memory Stick”
Flash	Recommended distance 0.5 to 3.8 m (1.6 to 12.5 ft) (W) 0.6 to 2.4 m (2 to 7.9 ft) (T) (when ISO sensitivity is set to Auto)

## Output connectors

A/V OUT (MONO) jack	Minijack Video: 1 Vp-p, 75 Ω, unbalanced, sync negative Audio: 327 mV (at a 47 kΩ load) Output impedance 2.2 kΩ
USB jack	mini-B

## LCD screen

LCD panel used	3.8 cm (1.5 type) TFT drive
Total number of dots	123 200 (560×220) dots

## Power, general

Used battery pack	NP-FC10
Power requirements	3.6 V
Power consumption (when shooting)	1.9W
Operating temperature range	0° to +40°C (32° to +104°F)
Storage temperature range	−20° to +60°C (−4° to +140°F)
Dimensions	114 × 51.5 × 35.8 mm (4 1/2 × 2 × 1 3/8 inches) (W/H/D, protruding portions not included)
Mass	206 g (7 oz) (NP-FC10 battery pack, “Memory Stick” and wrist strap included)
Microphone	Electret condenser microphone
Speaker	Dynamic speaker

## AC-LS1A AC power adaptor

Power requirements	AC 100 – 240 V, 50/60 Hz
Rated output voltage	DC 4.2 V, 1.5 A
Operating temperature range	0° to +40°C (32° to +104°F)
Storage temperature range	−20° to +60°C (−4° to +140°F)
Dimensions	105 × 36 × 56 mm (4 1/4 × 1 7/16 × 2 1/4 inches) (W/H/D, protruding parts not included)
Mass	Approx. 180 g (6 oz) (adaptor only)

## NP-FC10 battery pack

Used battery	Lithium ion battery
Maximum voltage	DC 4.2 V
Nominal voltage	DC 3.6 V
Capacity	2.4 Wh (675 mAh)

## Accessories

- A/V connecting cable (1)
- NP-FC10 battery pack (1)
- AC-LS1A AC power adaptor (1)
- Power cord (mains lead) (1)
- USB cable (1)
- Wrist strap (1)
- “Memory Stick” (16MB) (1)
- CD-ROM (USB driver: SPVD-008) (1)
- Operating Instructions (1)

Design and specifications are subject to change without notice.

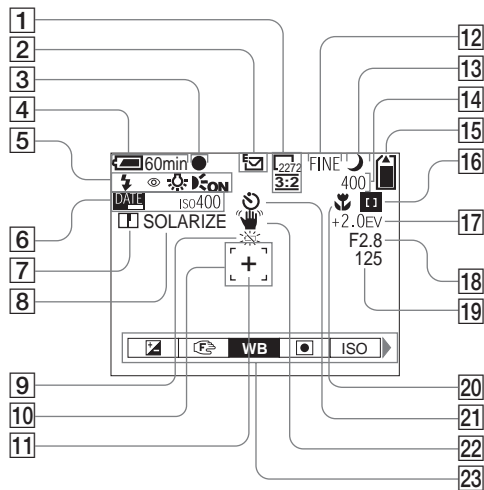

## The LCD screen

### For shooting still images



- 1 Image size indicator (19, 20)
- 2 Recording mode indicator (58 – 61)
- 3 AE/AF lock indicator (22, 54)
- 4 Remaining battery indicator display (11)

- 5 Flash mode (26)/Red-eye reduction (27)/White balance indicator (57)/AF illuminator indicator (27, 93)
- 6 Date/time indicator (29) ISO sensitivity (89)
- 7 Sharpness indicator (90, 91, 92)
- 8 Picture effect indicator (62)



- 9 Low battery warning (11)
- 10 AF range finder (53)
- 11 Spot light-meter aiming point (57)
- 12 Image quality indicator (19, 20)
- 13 Scene selection indicator (30)
- 14 Remaining images indicator (21) Self-diagnostics display (87)
- 15 Remaining “Memory Stick” capacity indicator (21)
- 16 Center AF  indicator (53)/ Focus preset value (55)
- 17 EV adjustment indicator (55)
- 18 Iris value indicator
- 19 Shutter speed indicator
- 20 Macro  (24)
- 21 Self-timer display (25)
- 22 Vibration warning indicator (86)
- 23 Menu/Guide menu (52)

- Pressing the MENU button switches the menu/guide menu on/off.

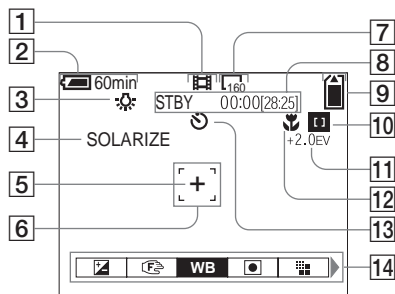
## For shooting movies



- 1 Recording mode indicator (71)
- 2 Remaining battery indicator display (11)
- 3 White balance indicator (57)
- 4 Picture effect indicator (62)
- 5 Spot light-metering aiming point (57)
- 6 AF range finder (53)
- 7 Image size indicator (71)
- 8 Recording time remaining indicator (Maximum recording time) indicator (12)/ Self-diagnostics display (87)
- 9 Remaining "Memory Stick" capacity indicator (21)

- 10 Center AF  indicator (53)/ Focus preset value (55)
  - 11 EV adjustment indicator (55)
  - 12 Macro  (24)
  - 13 Self-timer indicator (25)
  - 14 Menu/Guide menu (52)
- Pressing the MENU button switches the menu/guide menu on/off.

The page numbers in parentheses indicate the location of additional important information.

## For still image playback

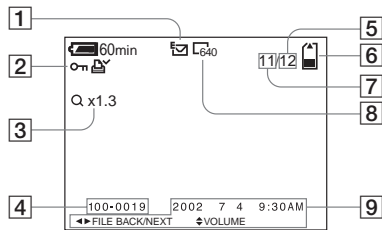

- 1 **Recording mode indicator** (61)
- 2 **Volume indicator** (61)/**Protection indicator** (66)/**Print mark indicator** (69)
- 3 **Zoom indicator** (63)
- 4 **File name** (50)
- 5 **Number of pages recorded in “Memory Stick”** (21)
- 6 **Remaining “Memory Stick” capacity indicator** (21)
- 7 **Image number** (21)
- 8 **Image size indicator** (19, 20)
- 9 **Date/time recorded indicator** (29)/**Menu/Guide menu** (52)

## For movie playback

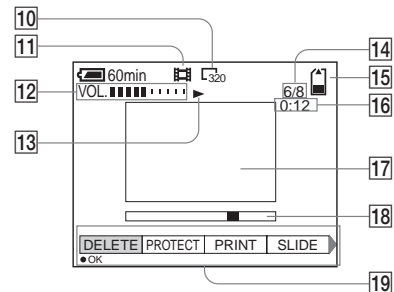

- 10 **Image size indicator** (72)
- 11 **Recording mode indicator** (72)
- 12 **Volume indicator** (72)
- 13 **Playback indicator** (72)
- 14 **Image number/Number of images recorded in the “Memory Stick”** (72)
- 15 **Remaining “Memory Stick” capacity** (72)
- 16 **Counter** (72)
- 17 **Playback screen** (72)
- 18 **Playback bar** (72)
- 19 **Menu/Guide menu** (52)

The page numbers in parentheses indicate the location of additional important information.

# Index

## A

Access lamp .....	18
AE/AF lock .....	22, 54
AE/AF lock lamp .....	9
AF ILLUMINATOR .....	93
AF illuminator .....	8, 27
AF lock .....	54
AF lock lamp (green) .....	9
Auto focus mode .....	55
Auto Power Off feature .....	15
A/V connecting cable .....	34

## B

Battery pack	
Battery life .....	12
Charging the battery pack .....	10
Charging time .....	12
Remaining indicator .....	11
Beep/shutter sound .....	94

## C

CD-ROM .....	42
Charging	
Charging the battery pack .....	10
Charging time .....	12
Computer	
Copying images .....	45, 51
Copying movies to your computer .....	77
USB cable .....	44
USB driver .....	42

Control button .....	15
Copying images .....	45, 51

## D

DC plug .....	10, 95
Deleting images .....	36
DIVIDE .....	75

## E

Editing still images	
Print mark .....	69
Protect .....	66
Resize .....	68
E-MAIL .....	61
EV adjustment .....	55
Exposure	
EV adjustment .....	55

## F

File	
File names .....	49
Image file storage destinations .....	49
Finder .....	28
Flash	
FLASH LEVEL .....	90, 91
RED EYE REDUCTION .....	27
Selecting a flash mode .....	26

## Focus

AE/AF lock lamp .....	9
AF lock .....	54
Focus preset .....	55
Shooting (using auto adjustment mode) .....	22
FORMAT .....	40

## G

GIF .....	50
-----------	----

## I

Image	
Copying images .....	45, 51
File names .....	49
Image file storage destinations .....	49
Image quality .....	19
Image size .....	19, 20, 88
Index .....	32
Installation	
USB driver .....	42
ISO .....	89

## J

JPG .....	50
-----------	----

## L

LCD screen display	
DSPL/LCD ON/OFF .....	28
LCD brightness .....	94

## M

Memory Stick	
Formatting a "Memory Stick" .....	40
Inserting a "Memory Stick" .....	18
Number of shooting images .....	21
The number of images that can be saved/ shooting time .....	88
Menu	
Changing menu .....	52
Mode dial .....	9, 52

Moisture condensation .....	95	Setting		Scene selection .....	30
Movie		Changing menu .....	52	Selecting a flash mode .....	26
Continuous shooting .....	13	Date and time .....	16	Shooting close-ups (Macro) .....	24
Copying movies to your computer .....	77	Image quality .....	19	Shooting with the date and time	
Cutting movies .....	75	Image size .....	19, 20, 88	inserted .....	29
Deleting movies .....	73	SET UP .....	52	Spot light-metering .....	56
Shooting movies .....	71	Setting the date and time .....	16	The number of images that can be saved ....	88
Viewing .....	72	SHARPNESS .....	90	The number of images that can be shot ....	12
MPG .....	50	Shooting close-ups (Macro) .....	24	Using auto adjustment mode .....	22
<b>N</b>		Shooting mode		Using the self-timer .....	25
NR slow shutter .....	31	Clip Motion .....	58	White balance .....	57
NTSC .....	94	E-MAIL .....	61	Zoom .....	24
<b>P</b>		MPEG MOVIE .....	71	<b>T</b>	
PAL .....	94	Shooting (using auto adjustment mode) ....	22	Trimming .....	64
Picture effect .....	62	Shooting in Multi Burst mode .....	59	TV set .....	34
Power		VOICE .....	61	<b>U</b>	
An external power source .....	14	Shooting with the date and time inserted ....	29	USB .....	42, 44
Battery pack .....	10	Still image playback		Using your camera abroad .....	14
Inserting battery pack .....	10	Index (nine images) screen .....	33	<b>V</b>	
ON/OFF .....	15	Quick Review .....	23	Viewing single images .....	32
Precautions .....	95	ROTATE .....	65	VOICE .....	61
<b>R</b>		Slide show .....	64	<b>W</b>	
RED EYE REDUCTION .....	27, 93	Using the zoom feature .....	24	Warnings and messages .....	86
RESET button .....	9, 87	Viewing images on a TV screen .....	34	<b>Z</b>	
<b>S</b>		Viewing single images .....	32	Zoom	
Scene selection .....	30	Viewing the images on your		Digital zoom .....	24
SCN .....	30	computer .....	48, 51	Playback zoom .....	63
Self-timer .....	25	Still image shooting		Using the zoom feature .....	24
		AE/AF lock lamp .....	9		
		Auto focus mode .....	55		
		EV adjustment .....	55		
		Image quality .....	19		
		Image size .....	19		
		Number of shooting images .....	21		
		Picture effect .....	62		



Printed on recycled paper

Printed using VOC (Volatile  
Organic Compound)-free  
vegetable oil based ink.

<http://www.sony.net/>

Sony Corporation Printed in Japan

Additional information on this product and answers to frequent  
asked questions can be found at our Customer Support Website.