

Video Cassette Recorder

Operating Instructions

Owner's record

The model and serial numbers are located at the rear of the unit. Record these numbers in the spaces provided below. Refer to them whenever you call upon your Sony dealer regarding this product.

Model No. _____

Serial No. _____

For hookup and setup, see the supplied hookup/setup manual.

VHS

Hi-Fi

VCR^{plus}
GOLD

GUIDE^{plus}
GEMSTAR

SLV-M20HF

WARNING

To prevent fire or shock hazard, do not expose the unit to rain or moisture.



This symbol is intended to alert the user to the presence of uninsulated "dangerous voltage" within the product's enclosure that may be of sufficient magnitude to constitute a risk of electric shock to persons.



This symbol is intended to alert the user to the presence of important operating and maintenance (servicing) instructions in the literature accompanying the appliance.

CAUTION

To prevent electric shock, do not use this polarized AC plug with an extension cord, receptacle or other outlet unless the blades can be fully inserted to prevent blade exposure.

WARNING

The AC power cord must be changed at qualified service shop.

Precautions

Safety

- Operate the unit only on 120 V AC, 60 Hz.
- If anything falls into the cabinet, unplug the unit and have it checked by qualified personnel before operating it any further.
- This unit is not disconnected from the AC power source (mains) as long as it is connected to the wall outlet, even if the unit itself has been turned off.
- One blade of the plug is wider than the other for the purpose of safety and will fit into the power outlet only one way. If you are unable to insert the plug fully into the outlet, contact your Sony dealer.
- Unplug the unit from the wall outlet if you do not intend to use it for an extended period of time. To disconnect the cord, pull it out by the plug, never by the cord.

Installing

- Allow adequate air circulation to prevent internal heat buildup.
- Do not place the unit on surfaces (rugs, blankets, etc.) or near materials (curtains, draperies) that may block the ventilation slots.

- Do not install the unit near heat sources such as radiators or air ducts, or in a place subject to direct sunlight, excessive dust, mechanical vibration or shock.
- Do not install the unit in an inclined position. It is designed to be operated in a horizontal position only.
- Keep the unit and cassettes away from equipment with strong magnets, such as microwave ovens or large loudspeakers.
- Do not place heavy objects on the unit.
- If the unit is brought directly from a cold to a warm location, moisture may condense inside the VCR and cause damage to the video head and tape. When you first install the unit, or when you move it from a cold to a warm location, wait for about one hour before operating the unit.

Information

For customers in the USA

You are cautioned that any changes or modifications not expressly approved in this manual could void your authority to operate this equipment.

This equipment has been tested and found to comply with the limits for a Class B digital device, pursuant to Part 15 of the FCC Rules. These limits are designed to provide reasonable protection against harmful interference in a residential installation. This equipment generates, uses, and can radiate radio frequency energy and, if not installed and used in accordance with the instructions, may cause harmful interference to radio communications. However, there is no guarantee that interference will not occur in a particular installation. If this equipment does cause harmful interference to radio or television reception, which can be determined by turning the equipment off and on, the user is encouraged to try to correct the interference by one or more of the following measures:

- Reorient or relocate the receiving antenna.
- Increase the separation between the equipment and receiver.
- Connect the equipment into an outlet on a circuit different from that to which the receiver is connected.
- Consult the dealer or an experienced radio/TV technician for help.

For customers in Canada

Operation is subject to the following two conditions: (1) this VCR may not cause interference, and (2) this VCR must accept any interference, including interference that may cause undesired operation of the VCR.

Caution

Television programs, films, video tapes and other materials may be copyrighted. Unauthorized recording of such material may be contrary to the provisions of the copyright laws. Also, use of this recorder with cable television transmission may require authorization from the cable television transmission and/or program owner.

Table of contents

Basic Operations

- 4 Playing a tape
- 6 Recording TV programs
- 10 Locating a channel using the channel list
- 12 Recording TV programs using VCR Plus+*
- 15 Setting the timer manually

Additional Operations

- 18 Playing/searching at various speeds
- 21 Searching for a selected point on the tape
- 23 Skip-searching automatically
- 24 Creating a favorite channel list
- 26 Recording TV programs using the quick timer
- 27 Checking/changing/canceling the manual timer settings
- 30 Recording stereo and bilingual programs
- 32 Searching using the index function
- 33 Adjusting the picture
- 34 Changing menu options
- 36 Editing with another VCR

SmartFile Function

- 38 About the SmartFile function
- 40 Recording using the SmartFile function
- 45 Selecting and playing a program
- 46 Checking the contents of a tape
- 47 Labelling a recorded program and tape
- 52 Protecting a recorded program
- 54 Erasing the data of an unwanted program
- 55 Storing program data from the DSS receiver (Program Data Download)

GUIDE Plus+* System

- 57 About the GUIDE Plus+ system
- 60 Overview of the GUIDE Plus+ menu
- 62 Using the Grid menu
- 67 Using the Sort menu
- 70 Using the Schedule menu
- 74 Using the Editor menu
- 76 Using the Demo menu

Additional Information

- 77 Troubleshooting
- 80 Specifications
- 81 Index to parts and controls
- 87 Index
- back cover
- Quick reference to using the VCR

* VCR Plus+, PlusCode and GUIDE Plus+ are trademarks of Gemstar Development Corporation. The VCR Plus+ and GUIDE Plus+ systems are manufactured under license from Gemstar Development Corporation and VCR Index Systems B.V., respectively.

Playing a tape

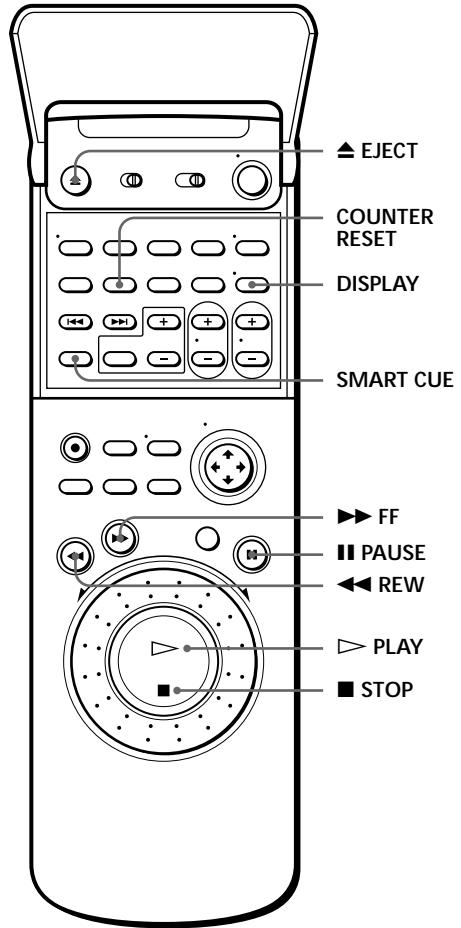

You can play back both VHS and S-VHS tapes on this VCR. However, you cannot obtain the original resolution quality of S-VHS (simplified playback).

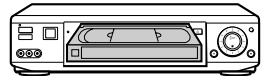

1 Turn on your TV and set it to the video channel.

2 Insert a tape.
The VCR turns on and starts playing automatically if you insert a tape with its safety tab removed.



3  Press  PLAY.
When the tape reaches the end, it will rewind automatically.

Additional tasks

To	Press
Stop play	■ STOP
Pause play	PAUSE
Resume play after pause	PAUSE or ▷ PLAY
Fast-forward the tape	▶▶ FF during stop
Rewind the tape	◀◀ REW during stop
Eject the tape	▲ EJECT

To skip playback

You can skip a portion of playback you don't want to watch such as a commercial and restart playback by pressing a single button.

- 1 Press SMART CUE during playback of the scene you want to skip. The VCR starts searching.
- 2 Press SMART CUE again when you find the scene you want to watch. The VCR stops searching, rewinds a few seconds, then resumes normal playback.

If you press and hold SMART CUE while the VCR is skip searching, the VCR will stop searching, and continue rewinding until you release SMART CUE.

Tip

- You can change the length of rewinding time on the ADVANCED OPTIONS menu. See page 35.

To use the time counter

At the point on the tape that you want to find later, press COUNTER RESET. The counter in the display window resets to "0:00:00." Search for the point afterwards by referring to the counter.

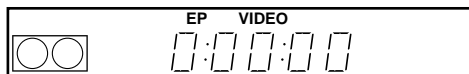

To display the counter on the TV screen, press DISPLAY.

Notes

- Tapes recorded in LP mode on other VCRs can be played back on this VCR but the picture quality cannot be guaranteed.
- The counter resets to "0:00:00" whenever a tape is reinserted.
- The counter stops counting when it comes to a portion with no recording.

Recording TV programs

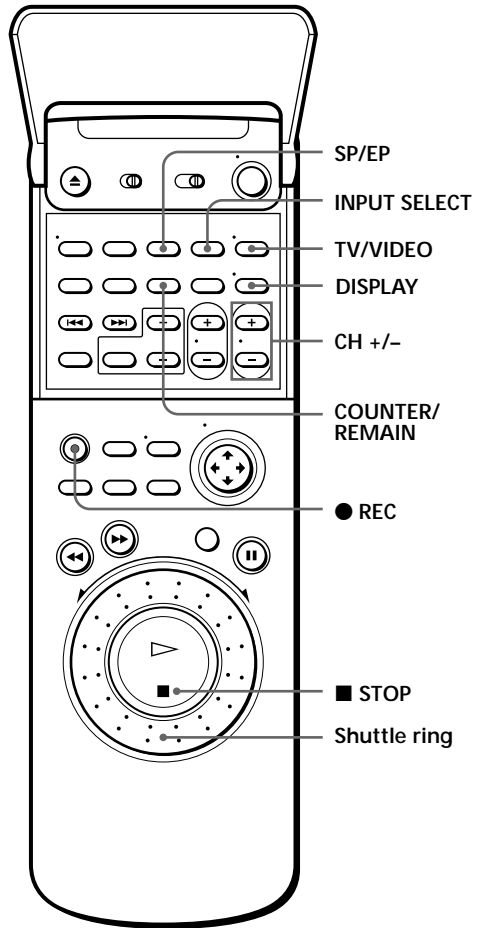

1 Turn on your TV and set it to the video channel.
To record from a cable box, turn it on.

2 Insert a tape with its safety tab in place.

3



Press INPUT SELECT until a channel number appears in the display window.

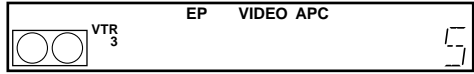

4



Press CH +/- to select the channel you want to record.

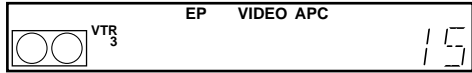

5



Press SP/EP to select the tape speed, SP or EP.

EP (Extra Play) provides recording time three times as long as SP (Standard Play); however, SP produces better picture quality.

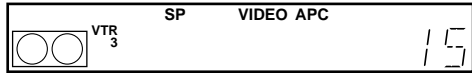

6



Press ● REC to start recording.

The recording indicator lights up red in the display window.

Recording indicator

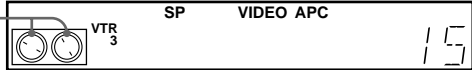

To stop recording

Press ■ STOP.

continued

Recording TV programs (continued)

To check the remaining tape length

Press DISPLAY. The white bar indicates the approximate length of tape remaining. With the display on, press COUNTER/REMAIN to check the remaining time. Each time you press COUNTER/REMAIN, the time counter and the remaining time appear alternately. The remaining time with the  indicator also appears in the display window.

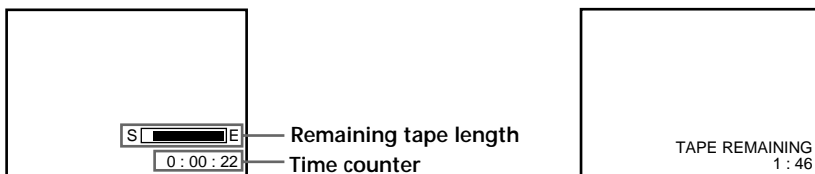

To check the remaining time of a T-140 or T-180 tape, set TAPE SELECT in the ADVANCED OPTIONS menu to "180." (For details, see page 35.)

To watch another TV program while recording

- 1 Press TV/VIDEO to turn off the VIDEO indicator in the display window.
- 2 If the TV is connected to the VCR's LINE OUT jacks, set the TV to TV input; if not, skip this step.
- 3 Select another channel on the TV.

To select a channel using the shuttle ring

To select a channel in step 4 above, you can also use the shuttle ring. During stop, turn the shuttle ring clockwise for higher channels or counterclockwise for lower channels. The VCR switches the channel in the preset order.

To save a recording

To prevent accidental erasure, break off the safety tab as illustrated. To record on a tape again, cover the tab hole with adhesive tape.



Tips

- To select a channel, you can use the number buttons on the remote commander. Enter the channel number, then press ENTER.
- You can select a video source from the LINE-1 IN or LINE-2 IN jacks using INPUT SELECT.
- The display appears on the TV screen indicating information about the tape, but the information won't be recorded on the tape.
- If you don't want to watch TV while recording, you can turn off the TV. When using a cable box, make sure to leave it on.
- You can set the channel with the shuttle ring during stop. However, you cannot set the channel with the shuttle ring on the remote commander when:
 - you set CABLE MOUSE in the CABLE BOX CONTROL menu to ON.
 - you press JOG so that the remote commander is in jog mode.

Notes

- The remaining time may not be indicated accurately for short tapes such as T-20 or T-30, or tapes recorded in LP mode.
- The display does not appear during still (pause) mode or slow-motion playback.
- It may take up to one minute for the VCR to calculate and display the remaining time after you press DISPLAY.

Locating a channel using the channel list

You can select the TV program from the channel list.

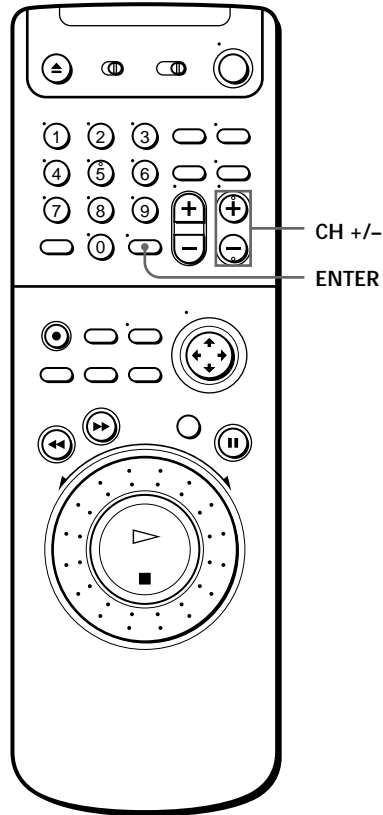

1 Turn on your TV and set it to the video channel.
When using a cable box, turn it on.

2  Press ENTER.
The channel list appears on the TV screen.

The selected channel

	3
	9
	10
	12
	13
	15
	19
	22
	43
	45

3



Press CH +/- to select the channel you want.

3
9
10
12
13
15
19
22
43
45

4



Press ENTER.

Recording TV programs using VCR Plus+

How VCR Plus+ works

Whenever you want to record a TV program, all you need to do is look up the program's "PlusCode," a number assigned to each program published in the TV section of most newspapers, cable TV listings, and even TV GUIDE magazine. Then, just enter the PlusCode of the program you want and the VCR is automatically programmed to record that show. It's that simple.

You can preset up to 20 programs with the GUIDE Plus+ timer for recording and/or viewing at one time.

Example of "PlusCode"

		PlusCode
5:30	14 MOVIE — Musical (2hrs.)	33044
	2 SPORT — Golf (1hr. 25min.)	42060
	CNN — WS 9974	
6:30	2 3 4 DRAMA — Comedy (2hrs.)	17390
	5 SCIENCE AND TECHNOLOGY (1hr. 15min.)	73457

Before you start...

- Check that the VCR clock is set to the correct time.
- Turn on your TV and set it to the video channel. When using a cable box, turn it on.
- Insert a tape with its safety tab in place. Make sure the tape is longer than the total recording time.
- If you insert a tape with the SmartFile function, make sure the total recording time doesn't overlap any protected programs. For details about the SmartFile function, see pages 52 through 53.

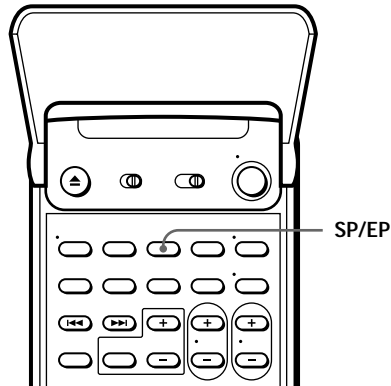
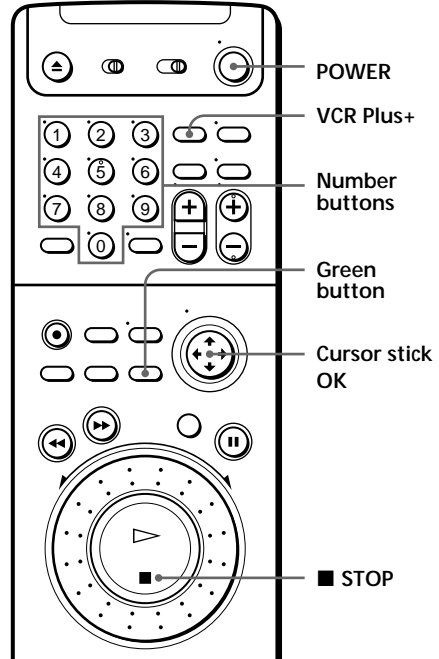



Press VCR Plus+.

When the Channel map selection menu appears on the TV screen, you have to select the channel map of your area. For details on how to select the channel map, see “To select the channel map” on page 59.

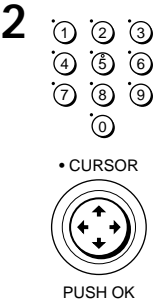
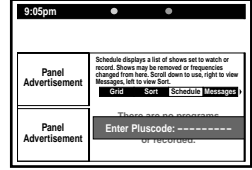

Press the number buttons to enter the program's PlusCode, then press the cursor stick (OK).

The date, start time, program name, and recording pattern appear on the TV screen. The program is set to be automatically recorded in EP mode.

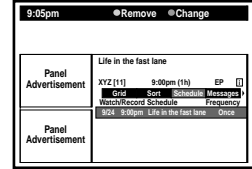

Press SP/EP to select the tape speed, SP or EP.

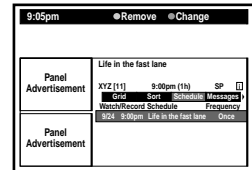

Press the green (Change) button repeatedly to select Once, Daily, or Weekly:

To record	Select
Only once	Once
Everyday Monday to Friday	Daily
Once a week	Weekly

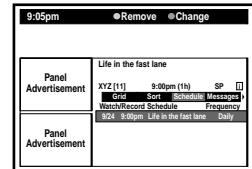

Press POWER to turn off the VCR.

The  indicator appears in the display window and the VCR stands by for recording. When using a cable box, leave it on.

continued

Recording TV programs using VCR Plus+ (continued)

To stop recording

To stop the VCR while recording, press ■ STOP.

To use the VCR after setting the timer

To use the VCR before a timer recording begins, just press POWER. The ☺ indicator turns off and the VCR switches on. Remember to press POWER to reset the VCR in timer recording standby after using the VCR.

You can also do the following tasks while the VCR is recording:

- Reset the counter.
- Display tape information on the TV screen.
- Check the timer settings.
- Watch another TV program.

To lock the VCR after setting the timer (Child Lock)

While the VCR turns on, hold POWER down on the VCR until the 🔒 indicator appears in the display window. The VCR turns off and the 🔒 indicator remains lit. The VCR will not work except for timer recording.

To unlock the VCR, hold POWER down on the VCR until the 🔒 indicator disappears from the display window. The VCR is unlocked and turns on.

To stop timer recording while the VCR is locked, press ■ STOP. The recording stops and the VCR is unlocked.

Tip

- To cancel VCR Plus+ recording, see “Canceling a VCR Plus+ or GUIDE Plus+ recording or viewing schedule” on page 71.

Notes

- If the VCR doesn't accept the PlusCode, this means that the PlusCode is incorrect.
- You cannot select Daily or Weekly for a program that airs more than seven days ahead.
- The VCR will be unlocked when:
 - you stop timer recording by pressing ■ STOP.
 - you insert a tape.
 - the AC power cord is disconnected or power supply stops.

Setting the timer manually

If VCR Plus+ and GUIDE Plus+ are not available in your area, follow the instructions below to set the timer to record programs. You can manually preset up to eight programs at one time not including those of VCR Plus+ and GUIDE Plus+ recording.

Before you start...

- Check that the VCR clock is set to the correct time.
- Turn on your TV and set it to the video channel. When using a cable box, turn it on.
- Insert a tape with its safety tab in place. Make sure the tape is longer than the total recording time.
- If you insert a tape with the SmartFile function, make sure the total recording time doesn't overlap any protected programs. For details about the SmartFile function, see pages 52 through 53.

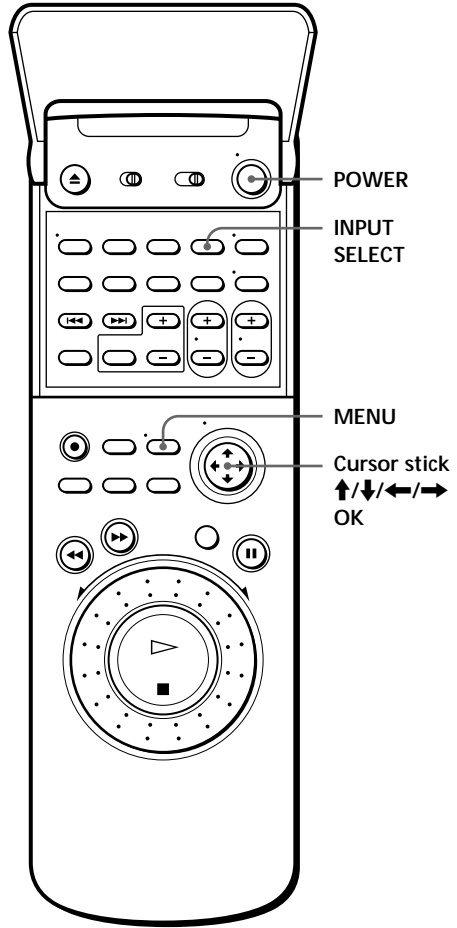

1



Press MENU and select TIMER SET/
CHECK.

TIMER SET / CHECK				11 / 16MON
DATE	START	STOP	CH	
- / -	- : -	- : -	- - -	-
- / -	- : -	- : -	- - -	-
- / -	- : -	- : -	- - -	-
- / -	- : -	- : -	- - -	-
- / -	- : -	- : -	- - -	-
- / -	- : -	- : -	- - -	-
- / -	- : -	- : -	- - -	-

continued

Setting the timer manually (continued)

2



Set the date, start and stop times, channel number and tape speed:

- 1 Push the cursor stick to **→** to highlight each item in turn.
- 2 Push the cursor stick to **↓/↑** to set each item.

TIMER SET / CHECK				11 / 16MON
DATE	START	STOP	CH	
11 / 18 WED	--:--	--:--	--	EP
- / - -	--:--	--:--	--	--
- / - -	--:--	--:--	--	--
- / - -	--:--	--:--	--	--
- / - -	--:--	--:--	--	--
- / - -	--:--	--:--	--	--
- / - -	--:--	--:--	--	--

To correct a setting, push the cursor stick to **←** to return to that setting and reset.

To record the same program every day or the same day every week, push the cursor stick to **↓** while the date is highlighting. For details, see “Daily/weekly recording” on the next page.

To record from a source connected to the LINE-1 IN or LINE-2 IN jacks, press INPUT SELECT to display “LINE1” or “LINE2” in the “CH” position.



3



Push the cursor stick to **→** to confirm the setting.

The cursor appears at the beginning of the line. To enter another setting, move the cursor to the next line and repeat step 2.

4



Press the cursor stick (OK).

5



Press POWER to turn off the VCR.

The  indicator appears in the display window and the VCR stands by for recording.

When using a cable box, leave it on.

Daily/weekly recording

In step 2 above, push the cursor stick to ↓ to select the recording pattern. Each time you push the cursor stick to ↓, the indication changes as shown below. Push the cursor stick to ↑ to change the indication in reverse order.

the current date → SUN-SAT → MON-SAT → MON-FRI → EVERY SAT
 → EVERY MON → EVERY SUN → 1 month later → (date counts down) →
 the current date

Tips

- To set the channel, you can also use the CH +/- or number buttons.
- You can set the channel with the shuttle ring during stop. However, you cannot set the channel with the shuttle ring on the remote commander when:
 - you set CABLE MOUSE in the CABLE BOX CONTROL menu to ON.
 - you press JOG so that the remote commander is in jog mode.
- To set the tape speed, you can also use the SP/EP button.
- When you are recording a program in SP mode and the remaining tape becomes shorter than the recording time, the tape speed is automatically changed to EP mode. Note that some noises will appear on the picture when the tape speed is changed. If you want to keep the same tape speed, set AUTO TAPE SPEED to OFF in the ADVANCED OPTIONS menu (page 35).
- To lock the VCR after setting the timer, see page 14.

Note

- If you are using cable box control, you cannot select “LINE1” or “LINE2.”

Playing/searching at various speeds

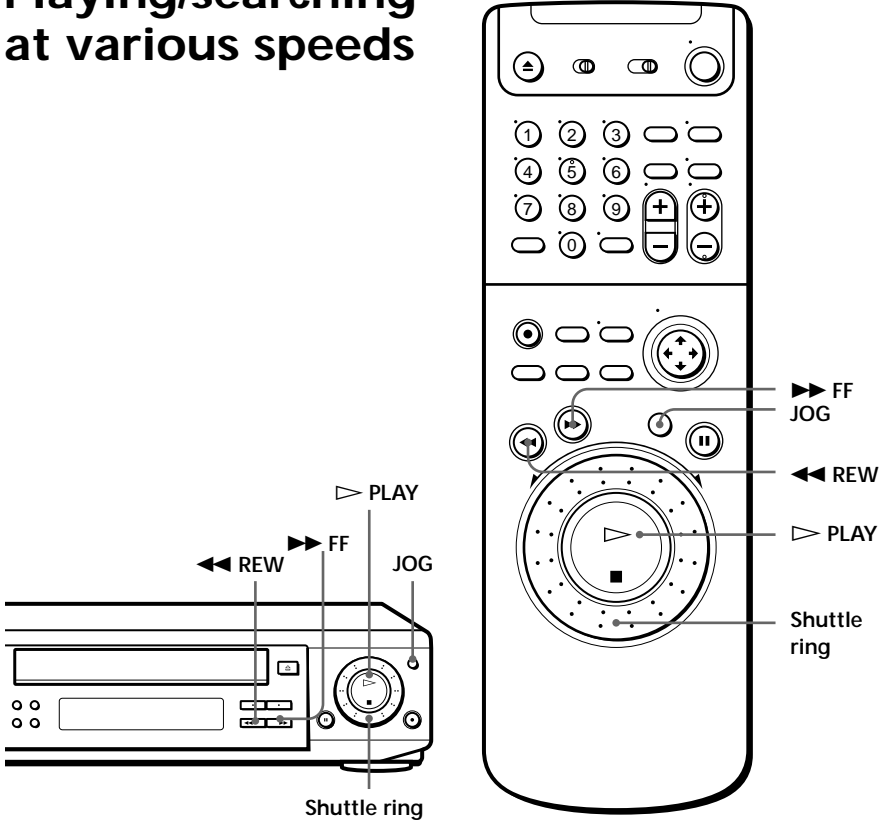

Playback options	Operation
View the picture during fast-forward or rewind	During fast-forward, hold ►► FF down. During rewind, hold ◀◀ REW down.
Search forward	Press ►► FF during playback.
Search backward	Press ◀◀ REW during playback.
Rewind and start play	During stop, hold ◀◀ REW <u>on the VCR</u> , and press ▷ PLAY <u>on the VCR</u> .

Using the shuttle ring

With the shuttle ring, you can operate a variety of playback options. There are two ways for using the shuttle ring, normal mode and jog mode.

To use the shuttle ring in normal mode

During playback or pause, turn the shuttle ring clockwise or counterclockwise. Each change in the shuttle ring position changes the playback mode, and the corresponding mark appears on the TV screen for a few seconds in the following way if the on-screen display function is on:

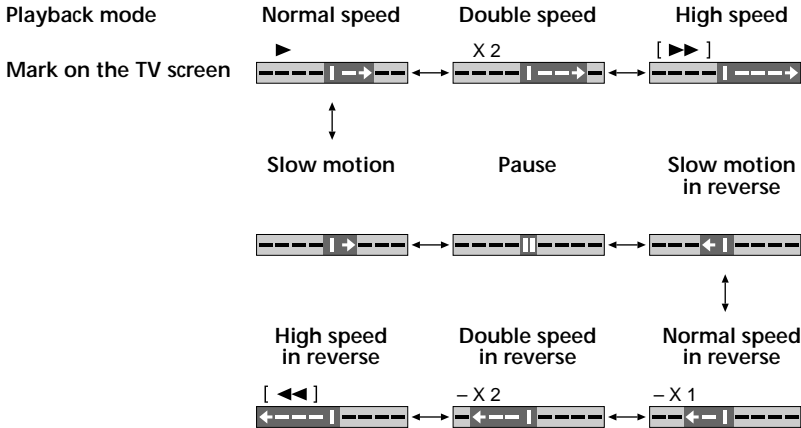

To use the shuttle ring in jog mode

Use this mode for frame-by-frame playback.

Press JOG to enter jog mode. The JOG button lights up. If you change to jog mode during any playback mode, the playback pauses so you can see a still picture. Each change in the shuttle ring position shifts the picture one frame. To shift frames in reverse, turn the shuttle ring counterclockwise.

The frame shift speed depends on the speed you turn the shuttle ring.

To resume normal playback, press JOG again. The JOG indicator goes off.

To resume normal playback

Press ▷ PLAY.

continued

Playing/searching at various speeds (continued)

Tip

- Adjust the picture using the TRACKING +/- buttons if:
 - streaks appear while playing in slow motion.
 - bands appear at the top or bottom while pausing.
 - the picture shakes while pausing.

Notes

- The sound is muted during these operations.
- Tapes recorded in LP mode on other VCRs can be played back on this VCR but the picture quality cannot be guaranteed.
- The picture may have snow:
 - when playing at high speed in reverse.
 - when playing in reverse slow motion.
 - when playing in reverse.
- If the playback mode mark doesn't appear on the TV screen, press DISPLAY.
- The picture may flutter a bit when playing in slow motion.

Searching for a selected point on the tape

You can easily find a specific point by moving the pointer on the TV screen. The VCR fast-forwards or rewinds to the point you indicate and starts playback automatically.

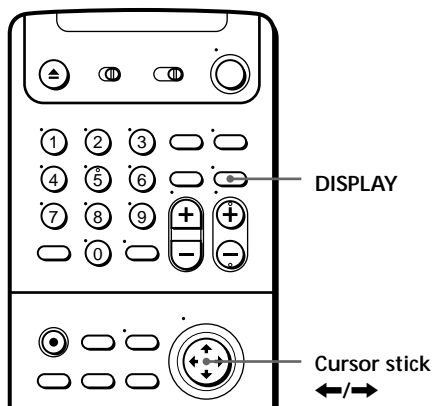

- 1 Press DISPLAY repeatedly until the bar indication appears on the TV screen.
A cursor (■) indicating the current position of the tape appears on the bar indication. If the cursor does not appear, play the tape a few moments (by pressing ▷ PLAY, ►► FF or ◀◀ REW) until the cursor appears.
- 2 Push the cursor stick to ◀/▶ to move the pointer (+) to the point where you want to start playback.

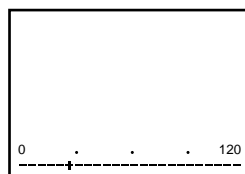

The VCR starts searching and the cursor (■) moves toward the pointer. When the VCR locates the marked point, playback starts.

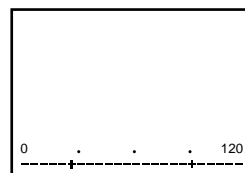

To cancel searching

Press ▷ PLAY or ■ STOP.

To turn off the bar indication

Press DISPLAY again.

continued

Searching for a selected point on the tape (continued)

Notes

- The figure on the bar indication represents the total time length of the inserted tape as shown below.
The total time length may not be displayed correctly for:
 - tapes other than T-60, T-120, or T-160
 - tapes recorded in more than one tape speed mode.

Tape type	Total time length		
	SP	LP	EP
T-60 or shorter	60	120	180
from T-80 to T-140	120	240	360
T-160 or longer	160	320	480

- If you move the pointer (+) on the bar indication during search, the VCR searches for the new reset point.

Skip-searching automatically

You can spot check a whole tape quickly. At intervals, the VCR skips playback while searching forward or backward.

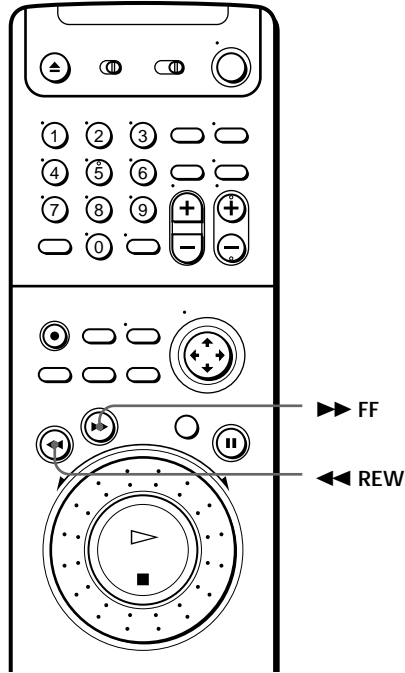

Press ►► FF (or ◀◀ REW) for more than two seconds during stop. “SKIP” appears on the TV screen.

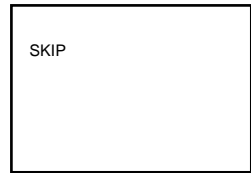

The VCR searches forward (or backward) for about two minutes on the counter, then fast-forwards (or rewinds) for about ten minutes on the counter. The VCR repeats this operation until it stops at the end (or beginning) of the tape.



To cancel skip-search

Press ▷ PLAY or ■ STOP.

Note

- The VCR automatically fast-forwards (or rewinds) any portion with no recording.

Creating a favorite channel list

You can create your favorite channel list from the TV channels. You can store up to 10 channels and select the channel from your favorite channel list.

Before you start...

- Turn on your TV and set it to the video channel. When using a cable box, turn it on.

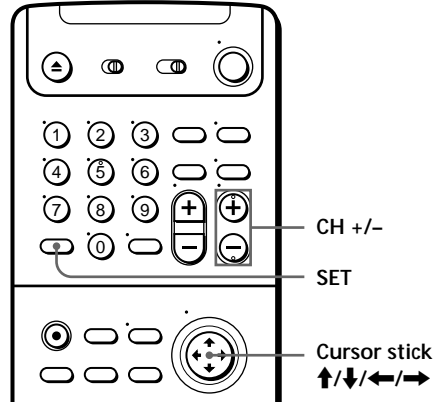

Creating your favorite channel list

- 1 Press SET.
The FAVORITE CH screen appears on the TV screen.
- 2 Press CH +/- to select the channel you want to replace.
You can also use the cursor stick (↑/↓) instead.
- 3 Push the cursor stick to ←/→ to select the channel you want to set.
- 4 Repeat steps 2 and 3 to set the channels as required.
- 5 Press SET.

The selected channel

FAVORITE CH	
	12
	15
	9
	13
	19
	3
	45
	43
	22
	10

FAVORITE CH	
	12
	15
	27
	13
	19
	3
	45
	43
	22
	10

Selecting a channel from your favorite channel list

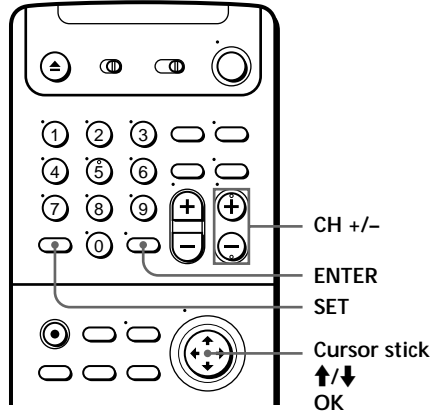

1 Press SET.

Your FAVORITE CH screen appears on the TV screen.

The selected channel

FAVORITE CH	
12	
15	
27	
13	
19	
3	
45	
43	
22	
10	

2 Press CH +/- to select the channel you want to select.

You can also use the cursor stick (↑/↓) instead.

FAVORITE CH	
12	
15	
27	
13	
19	
3	
45	
43	
22	
10	

3 Press ENTER.

You can also use the cursor stick (OK) instead.

Recording TV programs using the quick timer

After starting recording in the normal way, you can have the VCR stop recording automatically after a specified duration.

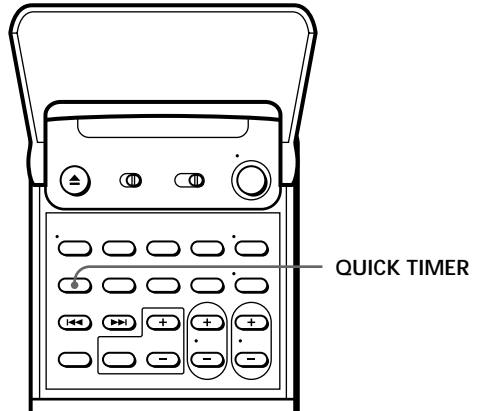

- 1 While recording, press QUICK TIMER once.

The ⏻ indicator appears in the display window.

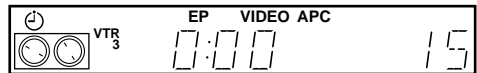

- 2 Press QUICK TIMER repeatedly to set the duration.

Each press advances the time in increments of 30 minutes.

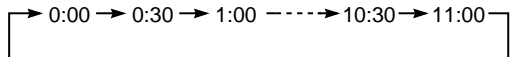

The duration decreases minute by minute to 0:00, then the VCR stops recording and turns off automatically.

To extend the duration

Press QUICK TIMER repeatedly to set to the new duration.

To stop while recording

Press ■ STOP.

Using the quick timer during stop mode

- 1 Press QUICK TIMER.
- 2 Press CH +/- or INPUT SELECT to select the channel you want to record.
- 3 Press QUICK TIMER repeatedly to set the recording duration. The recording starts.

Checking/ changing/ canceling the manual timer settings

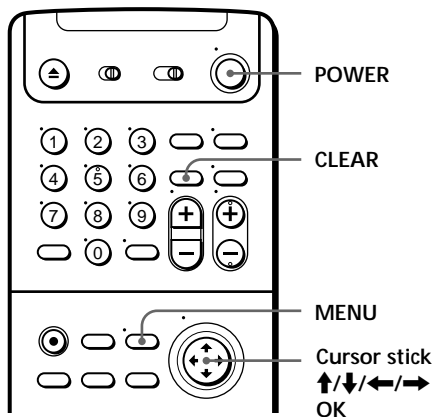

Before you start...

- Turn on your TV and set it to the video channel.

- 1 Press **POWER** to turn on the VCR.
- 2 Press **MENU** and select **TIMER SET/CHECK**:
 - If you want to change a setting, go on to the next step.
 - If you do not need to change the settings, press the cursor stick (**OK**), then turn off the VCR to return to recording standby.

TIMER SET / CHECK				11 / 16 MON	
DATE	START	STOP	CH		
11 / 18 WED	7 : 00 AM	8 : 00 AM	6	SP	
11 / 22 SUN	10 : 30 PM	11 : 15 PM	50	EP	
MON - SAT	1 : 00 AM	3 : 00 AM	LINE1	EP	
EVERY SUN	12 : 55 PM	1 : 30 PM	12	SP	
- / - / -	- : - : -	- : - : -	-	-	-
- / - / -	- : - : -	- : - : -	-	-	-
- / - / -	- : - : -	- : - : -	-	-	-

- 3 Push the cursor stick to **↑/↓** to select the setting you want to change:
 - To change the setting, push the cursor stick to **←/→** to highlight the item you want to change, and push the cursor stick to **↑/↓** to reset it. Then, push the cursor stick to **→** repeatedly until the cursor appears at the beginning of the line.
 - To cancel the setting, press **CLEAR**.
- 4 Press the cursor stick (**OK**).

If any timer settings remain, turn off the VCR to return to recording standby.

continued

Checking/changing/canceling the manual timer settings (continued)

When the manual timer settings overlap

The program that starts first has priority and the second program starts recording only after the first program has finished. If the programs start at the same time, the program listed first in the menu has priority.

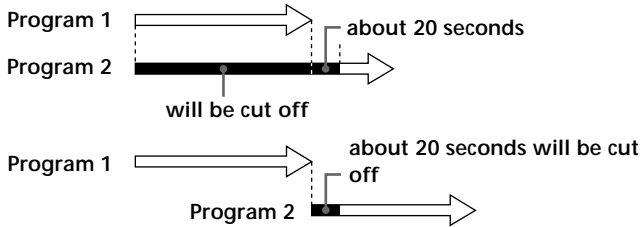

When the manual timer setting and the GUIDE Plus+ timer setting overlap

When the manual timer setting and the GUIDE Plus+ timer setting (including VCR Plus+ recording) overlap, the GUIDE Plus+ timer setting has priority. If you want to make more than one timer setting at one time, we recommend that you use the same timer setting method at that time for all timer settings, either the GUIDE Plus+ timer or the manual timer setting.

- If the recording stop time of the GUIDE Plus+ timer setting and the recording start time of the manual timer setting are set at the same time, the manual timer setting is canceled.

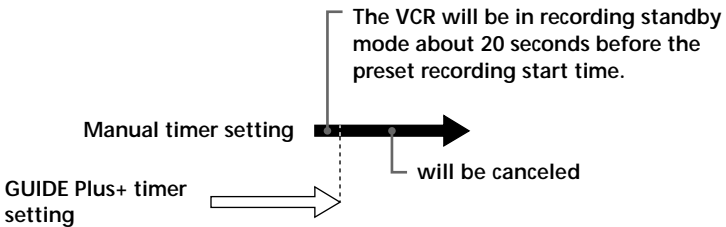

- If the manual timer setting and GUIDE Plus+ timer setting are scheduled to start at the same time, the VCR starts recording the program preset with the GUIDE Plus+ timer.
- If the GUIDE Plus+ timer setting is scheduled to start while the VCR is already recording a manual timer setting, the VCR stops recording the manual timer setting and starts recording the GUIDE Plus+ timer setting. If the recording stop time of the manual timer setting and the recording start time of the GUIDE Plus+ timer setting are set at the same time, the VCR stops recording of the manual timer setting about two minutes before the preset stop time.

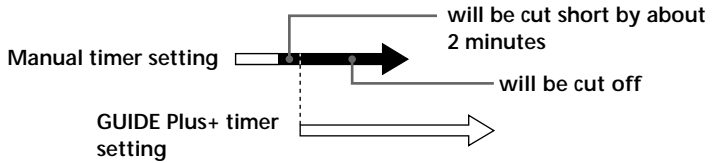

- If a manual timer setting is scheduled to start while the VCR is recording the GUIDE Plus+ timer setting, the manual timer setting is canceled.

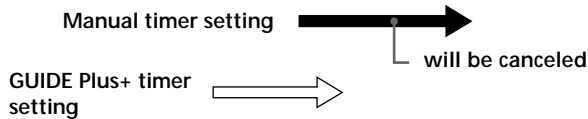

Recording stereo and bilingual programs

Recording stereo programs

This VCR automatically receives and records stereo programs. When a stereo program is received, the STEREO indicator lights up. If there is noise in the stereo program, set AUTO STEREO in the ADVANCED OPTIONS menu to OFF. The sound will be recorded in monaural (on both hi-fi and normal audio tracks) but with less noise. For details, see page 34.

Recording bilingual programs

Normally, this VCR records only the main sound. When a SAP (Second Audio Program) is received, the SAP indicator lights up. To record only SAP sound, set TUNER AUDIO in the ADVANCED OPTIONS menu to SAP. For details, see page 34.

Selecting the sound during playback

Press AUDIO MONITOR to select the sound you want. (The sound being recorded will not change.)

To listen to	On-screen display	Display window
Stereo/main (left and right channels)	STEREO	STEREO
Left channel only	LEFT CH	STEREO
Right channel only	RIGHT CH	STEREO
Monaural	No indicator	No indicator

How sound is recorded on a video tape

The VCR records sound onto two separate tracks. Hi-fi audio is recorded onto the main track along with the picture. Monaural sound is recorded onto the normal audio track along the edge of the tape.

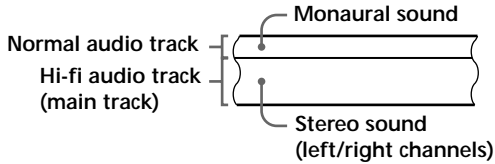

Notes

- To play a tape in stereo, you must use the A/V connections.
- When you play a tape recorded in monaural, the sound is heard in monaural regardless of the AUDIO MONITOR setting.
- If the AUDIO MONITOR button does not function, check that AUDIO MIX in the ADVANCED OPTIONS menu is set to OFF.

Searching using the index function

The VCR marks the tape with an index signal at the point where each recording begins. Use these signals as references to find a specific recording. The VCR can search up to 99 index signals ahead of or behind the current position.

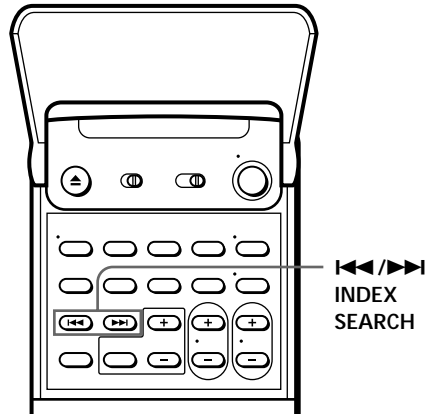

- 1 Insert an indexed tape into the VCR.
- 2 Press **◀◀/▶▶** INDEX SEARCH repeatedly to specify how many index signals ahead or behind you want to search:
 - To search ahead, press **▶▶** INDEX SEARCH.
 - To search backwards, press **◀◀** INDEX SEARCH.

The VCR starts searching and the index number on the TV screen counts down to zero. Playback starts automatically from that point.

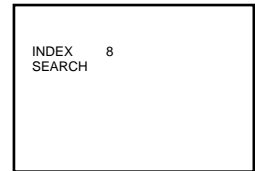

To stop searching
Press **■** STOP.

Adjusting the picture

Adjusting the tracking

Although the VCR automatically adjusts the tracking when playing a tape (the  indicator flashes in the display window, then goes off), distortion may occur if the tape was recorded in poor condition. In this case, manually adjust the tracking.

Press the TRACKING +/- buttons to display the tracking meter. The distortion should disappear as you press one of the two buttons (the  indicator lights up). To resume automatic tracking adjustment, eject the tape and reinsert it.

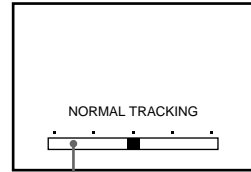

Tracking meter

About Adaptive Picture Control (APC)

Adaptive Picture Control (APC) automatically improves recording and playback quality by adjusting the VCR to the condition of the video heads and tape. To maintain better picture quality, we recommend that you set APC to ON in the ADVANCED OPTIONS menu (with the APC indicator in the display window lit). For details, see page 35.

APC playback

The APC function automatically works on all types of tapes, including rental tapes and tapes that were not recorded with APC.

APC recording

Whenever you insert a tape and first start recording, the VCR adjusts to the tape using the APC function (the APC indicator flashes rapidly). This adjustment is retained until the tape is ejected.

Notes

- Auto tracking adjustment cannot be guaranteed to work with tapes recorded in LP mode on other VCRs.
- The APC function does not work if the tape speed is automatically changed from SP to EP mode during a manual timer recording, unless the tape has been recorded in EP mode with the APC function.
- There is a delay of a few seconds before the VCR actually starts recording while the VCR analyzes the tape. To avoid the delay, first set the VCR to recording pause (the APC indicator flashes slowly) and press ● REC to have the VCR analyze the tape (the APC indicator flashes rapidly). After the APC indicator stops flashing, press ■ PAUSE to start recording immediately.

If you want to start recording quickly without using the APC function, first set the VCR to recording pause (the APC indicator flashes slowly) and press ■ PAUSE to start recording.

Changing menu options

- 1 Press MENU and select ADVANCED OPTIONS.
- 2 Push the cursor stick to **↑/↓** to select the option to change, then push the cursor stick to **←/→** to change the setting.
 The ADVANCED OPTIONS menu has 2 pages. To select page 2, push the cursor stick to **↓** repeatedly until page 2 appears. To select page 1, push the cursor stick to **↑** repeatedly until page 1 appears.
- 3 Press the cursor stick (OK) to return to the original screen.

Page 1

ADVANCED OPTIONS			page1
AUTO ANT SEL	ON	OFF	
AUTO STEREO	ON	OFF	
AUDIO MIX	ON	OFF	
TUNER AUDIO	MAIN	SAP	
SHARPNESS	L	-	H
DEFAULT SPEED	EP		

Use **↑/↓** to select an item, then push **←/→**

Page 2

ADVANCED OPTIONS			page2
APC	ON	OFF	
DIMMER	ON	OFF	
AUTO TAPE SPEED	ON	OFF	
TAPE SELECT	AUTO		180
SMART CUE	MEDIUM		

Use **↑/↓** to select an item, then push **←/→**

Menu choices

Initial settings are indicated in bold print.

Menu option	Set this option to
AUTO ANT SEL	ON if your TV is connected only to VHF/UHF OUT on the VCR. To play a tape, set the TV to the VCR channel (channel 3 or 4). OFF if your TV is connected to both VHF/UHF OUT and LINE OUT on the VCR. To play a tape, set the TV to the VCR input.
AUTO STEREO	ON to receive stereo programs, OFF to reduce noise. The sound changes to monaural.
AUDIO MIX	ON to listen to the sound recorded on hi-fi and normal audio tracks at the same time. The AUDIO MONITOR button will not function. OFF to listen to hi-fi and normal audio tracks separately. Select the sound using the AUDIO MONITOR button.
TUNER AUDIO	MAIN to record the main sound on both hi-fi and normal audio tracks. SAP to record the SAP (Second Audio Program) sound on both hi-fi and normal audio tracks.
SHARPNESS	L (Low) through H (High) to adjust the sharpness of the picture. L to turn off the sharpness control.
DEFAULT SPEED	EP to set the recording tape speed automatically back to EP after recording. SP to set the recording tape speed automatically back to SP after recording. FLOAT to set the recording tape speed to the last position selected from the SP/EP button.

Menu option	Set this option to
APC	ON to switch on the APC (Adaptive Picture Control) function and improve picture quality, OFF to switch off APC.
DIMMER	ON to make the display window dim, OFF to make it brighter.
AUTO TAPE SPEED	ON to change the manual timer recording tape speed automatically to EP mode when the remaining tape becomes shorter than the recording time, OFF to keep the same tape speed.
TAPE SELECT	AUTO or 180 (when using a T-140 or T-180) to select the tape length and display the remaining time correctly.
SMART CUE	MEDIUM to set the automatic rewinding time on skip playback to a medium length, SHORT to set to short, LONG to set to long.

Notes

- If you set the **DEFAULT SPEED** option to **EP**, you can still change the recording tape speed to **SP**, or vice versa by pressing the **SP/EP** button only for that program. Next time you record a program, the recording tape speed is automatically set to the position you set in the **DEFAULT SPEED** option.
- The Auto Tape Speed function doesn't work for the **VCR Plus+** and the **GUIDE Plus+** recordings.

Editing with another VCR

How to hook up to record on this VCR

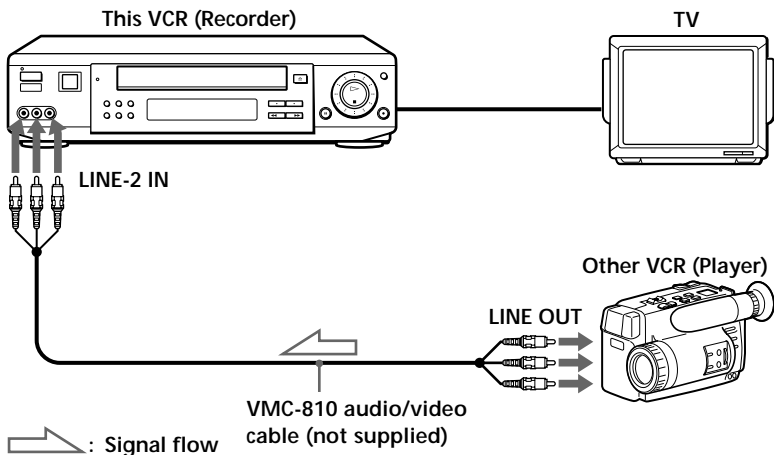

How to hook up to a stereo system

Connect LINE-2 IN AUDIO on this VCR to the audio output jacks on the stereo system, using the RK-C510KS audio cable (not supplied).

If the other VCR has a CONTROL S OUT jack for synchronized editing

Hook up to record on the other VCR, then connect the VCRs via the CONTROL S jacks. The CONTROL S connection lets you control (pause and release pause) both VCRs from the recording VCR.

Notes

- Make sure you connect the plugs to jacks of the same color.
- If the other VCR is a monaural type and connected to this VCR's LINE-2 IN jacks, connect the audio plug to the AUDIO L (white) jack. The sound is recorded on both right and left channels. When connecting to the AUDIO R (red) jack, the sound is recorded only on the right channel.
- If you connected this VCR to both the LINE IN and LINE OUT jacks of the other VCR, select the input correctly to prevent a humming noise.
- You can also use the LINE-1 IN jacks instead. If the other VCR is a monaural type, the sound is recorded only on the channel whose jack is connected to the audio plug. To record on both right and left channels, connect the audio plugs to the AUDIO R/L jacks using a VMC-910MS audio/video cable (not supplied).
- If the CONTROL S IN jack is used for S-Link™ (A/V bus control) with a TV, the CONTROL S connection cannot be used for editing.

Operation (when recording on this VCR)

Before you start editing

- Turn on your TV and set it to the video channel.
- Press INPUT SELECT to display “L2” or “L1” in the display window.
- Press SP/EP to select the tape speed, SP or EP.

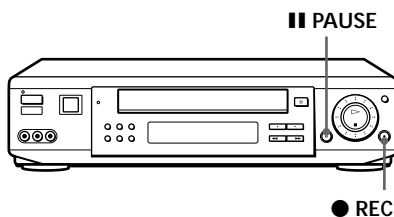

- 1 Insert a source tape with its safety tab removed into the other (playback) VCR. Search for the point to start playback and set it to playback pause.
- 2 Insert a tape with its safety tab in place into this (recording) VCR. Search for the point to start recording and press || PAUSE.
- 3 Press ● REC on this VCR and set it to recording pause.
- 4 To start editing, press the || PAUSE buttons on both VCRs at the same time.

To stop editing

Press the ■ STOP buttons on both VCRs.

Tips

- To edit more precisely, press the || PAUSE buttons on the VCRs to release pause.
- To cut out unwanted scenes while editing, press || PAUSE on this VCR when an unwanted scene begins. When it ends, press || PAUSE again to resume recording (Assemble Editing).

Note

- If you start recording following the procedure above, the VCR won't start recording with the APC function. To record a tape with the APC function, press ● REC again during recording pause in step 3 so that the VCR analyzes the tape. Then when you start recording in step 4, press || PAUSE immediately after the APC indicator stops flashing. If you press || PAUSE before the APC indicator stops flashing, the APC function is canceled.

Labelling a recorded program and tape (page 47)

You can attach an electronic “label” to the video tape and its programs on the SmartFile list. Labelling the recorded programs enables you to find a program easily when you want to play it back.

Protecting a recorded program (page 52)

You can protect a recorded program from accidental over-recording or erasure.

Erasing the data of an unwanted program (page 54)

By erasing a program from the SmartFile list, the VCR will record over the unwanted program.

Storing program data from the DSS receiver (Program Data Download) (page 55)

If you connect a DSS receiver equipped with the Program Data Download function, you can store the program and category name transmitted from the DSS on a SmartFile tape. The DSS receiver equipped with the Data Download function will be available in the future.

Recording using the SmartFile function

To use the SmartFile function, attach the SmartFile label to the spine of the cassette tape. If you record a program on a tape with a SmartFile label, program data, such as the program name, category, date, and channel, is automatically stored in the memory of the SmartFile label.

Attaching the SmartFile label to the cassette tape

To use the SmartFile function, attach the supplied SmartFile label to the cassette tape. Remove any stains or dirt from the surface of the spine of the tape. Then, holding both edges of the SmartFile label so that it doesn't bend, attach it along the guide line to the spine of the cassette tape. This tape is henceforth referred to as a SmartFile tape.

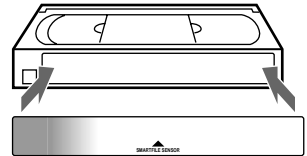

Note on the purchase of SmartFile labels

- **For the customers in the USA**
To order additional SmartFile labels, see the back page.
- **For the customers in Canada**
Additional SmartFile labels can be purchased at Sony of Canada Ltd. Authorized VHS Dealers.

Notes

- The SmartFile label is equipped with a memory chip. The memory chip may be damaged and cannot be used when you:
 - twist or fold the SmartFile label.
 - remove the SmartFile label and re-attach it to a tape.
 - attach more than one SmartFile label to a tape.
 - attach some metal, or sticker which has metal, to the SmartFile label.
 - write too strongly on the SmartFile label using a ballpoint pen or similar sharp instrument.
 - disassemble or remodel a label.
- Do not leave the SmartFile label in a place subject to excessive dust or dirt, direct sunlight, humidity, mildew, strong magnetism, or near heat sources.
- If you attach the SmartFile label to a short length tape, such as T-30 or shorter, you cannot use the SmartFile function.

Recording a program on the SmartFile tape

When recording a program on the SmartFile tape, no matter what method you use to record the program (normal recording, VCR Plus+ recording, GUIDE Plus+ recording, etc.), program data (date, channel, recording start time, etc.) is stored in the memory of the SmartFile label. If you record a program using VCR Plus+ or GUIDE Plus+, you can also store in memory the program and category name transmitted from certain TV stations. The SmartFile label can contain up to 12 programs' data. When the number of the stored programs goes over 12, the oldest program data is erased from the SmartFile list. However, a program which lasts less than about 15 minutes in EP mode or about 5 minutes in SP mode cannot be stored in the memory.

When you record a program on the SmartFile tape which already contains program data, see "Recording after locating the Blank Time space" on page 43.

Before you start...

- Turn on your TV and set it to the video channel.

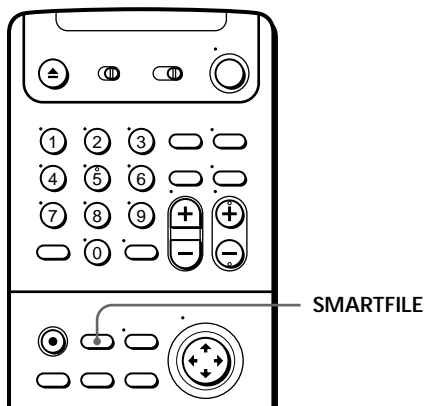

- 1 Insert a SmartFile tape with its safety tab in place.
The VCR turns on, the SMARTFILE indicator lights up, and the SmartFile search list automatically appears on the TV screen.

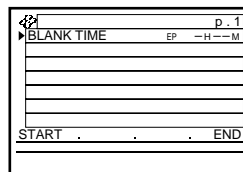

- 2 Press SMARTFILE.
The SmartFile search list disappears.
- 3 Start recording a program.

Tip

- You can protect a recorded program from accidental over-recording or erasure (see page 52).

Note

- If you press the **||** PAUSE button one or more times during recording, thereby creating short lengths of recorded time between such pauses, program data may not be stored in the SmartFile label.

continued

Recording using the SmartFile function (continued)

To check the information of a recorded program

Press SMARTFILE. The SmartFile search list appears. The recording day of the week, start time, channel, date, station ID, recording time, and tape speed appear on the list. The longest space which doesn't have any program data (Blank Time space) appears as "BLANK TIME."

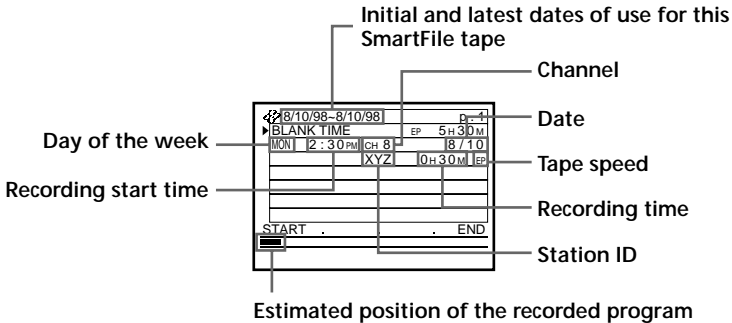

Tips

- When you record a program using VCR Plus+ or GUIDE Plus+, the program and category name may appear on the list instead of the day of the week, recording start time, and channel.
- You can manually label a recorded program and select the category. You can also label the SmartFile tape. See pages 47 through 51.

Notes

- The station ID appears only if the broadcaster sends this information.
- If you don't set the clock or the clock isn't set to the correct time, the recording time won't be stored correctly on the SmartFile list.
- When you record a program using the normal recording mode while the CABLE MOUSE option is set to ON in the CABLE BOX CONTROL menu, the channel number is stored as "CH--."
- When you set the AUTO TAPE SPEED option to ON in the ADVANCED OPTIONS menu, and the tape speed automatically changes from SP to EP during manual timer recording, the VCR displays the entire recording time converted in SP mode to the SmartFile list.
- The recording time length in the SmartFile list is an estimation and may be slightly different from the actual recorded time length.

Recording after locating the Blank Time space

The SmartFile function identifies not only the largest amount of available blank space, but also recorded material that doesn't have corresponding program data stored in the SmartFile label. The longest available recording space (including programs that are not stored on the SmartFile label) is referred to as "Blank Time space." You can locate the beginning of the Blank Time space for recording. If there is a recorded program after the Blank Time space, the VCR will over-record on that program unless you stop recording. If there is a program you want to prevent from being recorded over or erased, protect that program before you start recording another program (see pages 52 through 53).

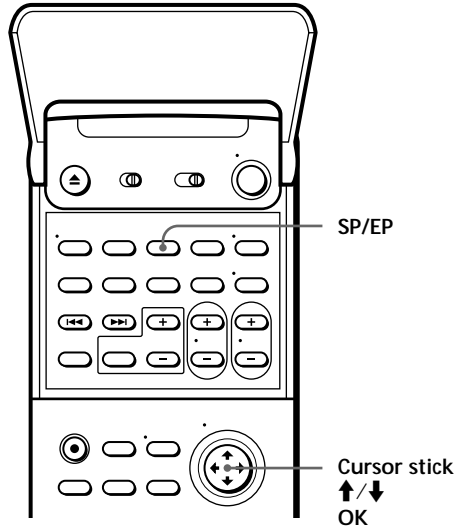

Before you start...

- Turn on your TV and set it to the video channel.

- 1 Insert a SmartFile tape with its safety tab in place.

The VCR turns on, the SMARTFILE indicator lights up, and the SmartFile search list automatically appears on the TV screen. The Blank Time space appears in the "BLANK TIME" row.

8/10/98-8/16/98		p. 1	
▶ BLANK TIME		EP	1H 48M
SUN	6:30PM CH 16	8/16	
		0H 30M	SP
THU	8:00PM CH 12	8/13	
		0H 50M	SP
MON	2:30PM CH 8	8/10	
		0H 30M	EP
START	.	.	END

The Blank Time space also appears in the display window.

- 2 Push the cursor stick to ↑/↓ to select BLANK TIME.

BLANK TIME is on page 1 of the SmartFile search list.

8/10/98-8/16/98		p. 1	
▶ BLANK TIME		EP	1H 48M
SUN	6:30PM CH 16	8/16	
		0H 30M	SP
THU	8:00PM CH 12	8/13	
		0H 50M	SP
MON	2:30PM CH 8	8/10	
		0H 30M	EP
START	.	.	END

continued

Recording using the SmartFile function (continued)

- 3** Press SP/EP to select the tape speed, SP or EP.

The BLANK TIME changes according to the selected tape speed. Select a tape speed that matches the length of the program you want to record.

8/10/98-8/16/98	p. 1
▶BLANK TIME	SP 0H 36M
SUN 6:30PM CH 16	8/16
	0H 30M SP
THU 8:00PM CH 12	8/13
	0H 50M SP
MON 2:30PM CH 8	8/10
	0H 30M EP
START . . .	END

- 4** Press the cursor stick (OK).

The VCR goes to the beginning of the Blank Time space and stops.



- 5** Start recording.

Notes

- If a newly recorded program overlaps a stored program, the stored program information is erased from the SmartFile list when:
 - the stored program is over-recorded for more than about 15 minutes in EP mode and about 5 minutes in SP mode.
 - the remaining length of the stored program becomes less than about 15 minutes in EP mode and about 5 minutes in SP mode.
- You may not be able to locate the beginning of the Blank Time space correctly in the above step 4 when:
 - the SmartFile tape contains one or more short length (less than about 15 minutes in EP mode and about 5 minutes in SP mode) recorded programs of which program data are not stored in the SmartFile label.
 - the SmartFile tape is damaged or dirty.

Selecting and playing a program

You can automatically locate and start playback of a program recorded on the SmartFile tape. Select a program in the SmartFile search list. The SmartFile search list can contain up to 12 programs.

Before you start...

- Turn on your TV and set it to the video channel.

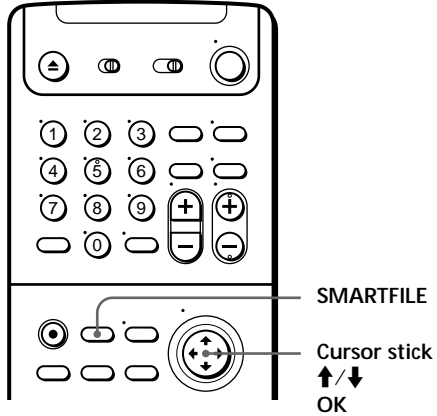

1 Insert a SmartFile tape.

The VCR turns on, the SMARTFILE indicator lights up, and the SmartFile search list automatically appears on the TV screen.

If the SmartFile tape is already inserted, press SMARTFILE.

8/10/98-8/16/98	p. 1
BLANK TIME	EP 1H48M
SUN 6:30PM CH 16	8/16
	0H30M SP
THU 8:00PM CH 12	8/13
	0H50M SP
MON 2:30PM CH 8	8/10
	0H30M EP
START	END

2 Push the cursor stick to ↑/↓ to select a program.

Pushing the cursor stick to ↑/↓ repeatedly will turn the pages.

8/10/98-8/16/98	p. 1
BLANK TIME	EP 1H48M
SUN 6:30PM CH 16	8/16
	0H30M SP
THU 8:00PM CH 12	8/13
	0H50M SP
MON 2:30PM CH 8	8/10
	0H30M EP
START	END

3 Press the cursor stick (OK).

The VCR starts searching for the beginning of the selected program. Playback starts automatically from that point.

To stop searching

Press ■ STOP.

Note

- You may not be able to locate the beginning of the selected program correctly when:
 - the SmartFile tape contains one or more short length (less than about 15 minutes in EP mode and about 5 minutes in SP mode) recorded programs of which program data are not stored in the SmartFile label.
 - the SmartFile tape is damaged or dirty.

Checking the contents of a tape

You can display the program data list of a SmartFile tape on the TV screen. It is not necessary to insert the tape into the VCR. This feature allows you to quickly find a specific program or to find a tape with enough recording space. The SmartFile check list can contain up to 12 programs.

Before you start...

- Turn on your TV and set it to the video channel.

- 1 Hold the label side of the SmartFile tape close to the SmartFile sensor. Slowly bring the center of the label within 3 cm of the SmartFile sensor.

There is a short beep, the SMARTFILE indicator lights up, and the SmartFile check list appears.

The Blank Time space also appears in the display window.

- 2 Press CURSOR ↓ repeatedly to turn the pages.

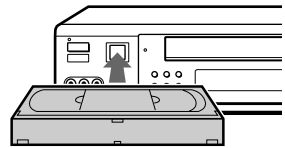
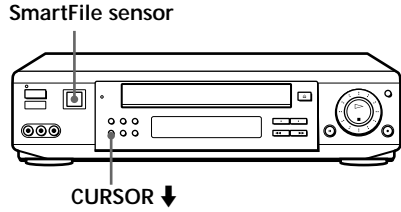

8/10/98-8/30/98		p. 1	
BLANK TIME EP 1H 48M			
SUN	9:00PM	CH 16	8/30
SAT	6:30PM	CH 4	8/29
THU	8:00PM	CH 12	8/27
THU	5:45PM	CH 7	8/27
WED	1:00PM	CH 12	8/26
MON	4:30PM	CH 8	8/24
NEXT: [Left/Right]		QUIT: [OK]	

8/10/98-8/30/98		p. 2	
BLANK TIME EP 1H 48M			
SAT	6:30PM	CH 16	8/22
THU	8:00PM	CH 12	8/20
MON	9:30PM	CH 16	8/17
SUN	6:30PM	CH 16	8/16
THU	8:00PM	CH 12	8/13
MON	2:30PM	CH 8	8/10
BACK: [Left/Right]		QUIT: [OK]	

Tips

- The SmartFile check list automatically disappears after about three minutes of nonuse.
- If you press a button other than SP/EP or the cursor stick (OK), the SmartFile check list disappears.
- You can turn the pages by pushing the cursor stick to ↑/↓ on the remote commander.

Notes

- You cannot display the SmartFile check list while:
 - you display the SmartFile list of a different SmartFile tape inserted into the VCR.
 - you display any other menu.
- If the SmartFile check list doesn't appear on the TV screen, try again by drawing the SmartFile tape away from the SmartFile sensor at least 5 cm, then bring it back to within 3 cm of the sensor.

Labelling a recorded program and tape

You can electronically “label” a program and select a category, such as SPECIAL or MOVIE, for a recorded program in the SmartFile list. You can also label a tape. Up to 18 characters can be input for a program and tape label.

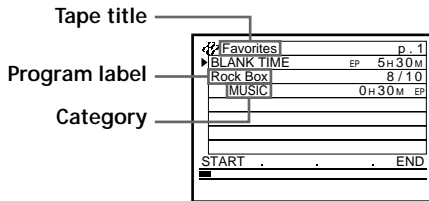

Labelling a recorded program and selecting a category

Before you start...

- Turn on your TV and set it to the video channel.

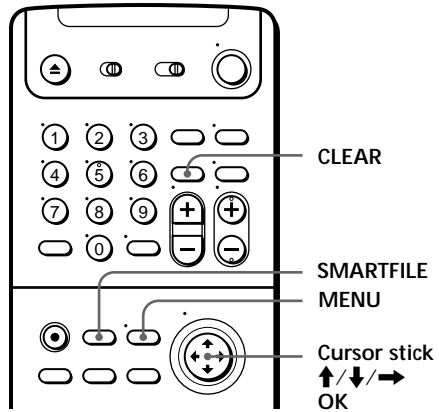

- 1** Insert a SmartFile tape.

The VCR turns on, the SMARTFILE indicator lights up, and the SmartFile search list automatically appears on the TV screen.
- 2** Press SMARTFILE.

The SmartFile search list disappears.

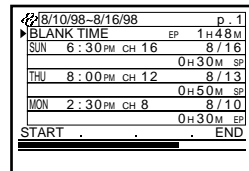

continued

Labelling a recorded program and tape (continued)

- 3** Press MENU and select SMARTFILE EDIT.
The SMARTFILE EDIT menu appears.

SMARTFILE EDIT		p. 1
8/10/98-8/16/98		
SUN	6:30PM CH 16	8/16
		0H30M SP
THU	8:00PM CH 12	8/13
		0H50M SP
MON	2:30PM CH 8	8/10
		0H30M EP
SELECT :	←→	QUIT : MENU
CATEGORY :	□	TITLE : □

- 4** Push the cursor stick to ↑/↓ to select a program.

SMARTFILE EDIT		p. 1
8/10/98-8/16/98		
SUN	6:30PM CH 16	8/16
		0H30M SP
THU	8:00PM CH 12	8/13
		0H50M SP
MON	2:30PM CH 8	8/10
		0H30M EP
SELECT :	←→	QUIT : MENU
CATEGORY :	□	TITLE : □

- 5** Push the cursor stick to →.
The cursor moves to the program label input position.

SMARTFILE EDIT		p. 1
8/10/98-8/16/98		
SUN	6:30PM CH 16	8/16
		0H30M SP
		8/13
		0H50M SP
MON	2:30PM CH 8	8/10
		0H30M EP
SELECT :	←→	CONFIRM : OK
BACK :	□	NEXT : □

- 6** Label the program.

- 1** Push the cursor stick to ↑/↓ to select a character.

Each time you push the cursor stick to ↓, the character changes as shown below.

A → B → ... → Z → symbol → 0 →
1 → ... → 9 → a → b → ... → z →
(blank space)

If you make a mistake, press CLEAR.

- 2** To set the next character, push the cursor stick to →.

The cursor moves to the next position.

SMARTFILE EDIT		p. 1
8/10/98-8/16/98		
SUN	6:30PM CH 16	8/16
		0H30M SP
N		8/13
		0H50M SP
MON	2:30PM CH 8	8/10
		0H30M EP
SELECT :	←→	CONFIRM : OK
BACK :	□	NEXT : □

SMARTFILE EDIT		p. 1
8/10/98-8/16/98		
SUN	6:30PM CH 16	8/16
		0H30M SP
N		8/13
		0H50M SP
MON	2:30PM CH 8	8/10
		0H30M EP
SELECT :	←→	CONFIRM : OK
BACK :	□	NEXT : □

- 3** Repeat steps **1** and **2** to label the program.

7 Press the cursor stick (OK).

SMARTFILE EDIT		p. 1
8/10/98-8/16/98		
SUN	6:30 PM CH 16	8/16
		0H30M SP
Nick & Matt		8/13
		0H50M SP
MON	2:30 PM CH 8	8/10
		0H30M EP
SELECT :	↕	CONFIRM : OK

8 Push the cursor stick to ↑/↓ to select a category.

Each time you push the cursor stick to ↓, the category changes as shown below.

SPECIAL → MOVIE → NEWS → SHOW →
SPORTS → KIDS → MUSIC → ARTS →
SERIES → EDUCATI (education) → HOBBY →
SHOPPIN (shopping) → VARIETY →
COMEDY → DRAMA → DAYTIME →
HOW TO → OTHERS → (blank)

SMARTFILE EDIT		p. 1
8/10/98-8/16/98		
SUN	6:30 PM CH 16	8/16
		0H30M SP
Nick & Matt		8/13
		0H50M SP
MON	2:30 PM CH 8	8/10
		0H30M EP
SELECT :	↕	CONFIRM : OK

9 Press the cursor stick (OK).

The program label and a selected category are stored.

10 Press MENU.

The menu disappears.

To erase the program label

Press CLEAR after step 4 above. The program label is erased and the recording day of the week, start time, and channel number reappear.

To erase the selected category

Press CLEAR in step 8 above. The selected category is erased and the space becomes blank.

continued

Labelling a recorded program and tape (continued)

Labelling a tape

Before you start...

- Turn on your TV and set it to the video channel.

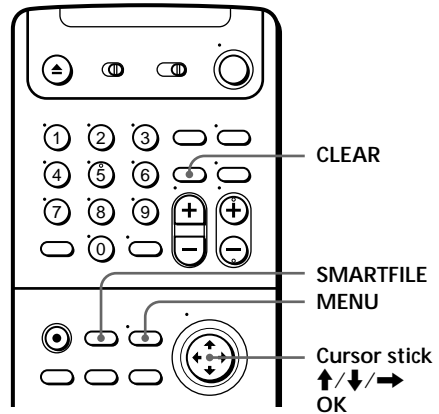

1 Insert a SmartFile tape.

The VCR turns on, the SMARTFILE indicator lights up, and the SmartFile search list automatically appears on the TV screen.

#8/10/98-8/16/98	p. 1
BLANK TIME	EP 1H48M
Someday	8 / 16
DRAMA	0H30M SP
Nick & Matt	8 / 13
COMEDY	0H50M SP
Rock Box	8 / 10
MUSIC	0H30M EP
START	END

2 Press SMARTFILE.

The SmartFile search list disappears.

3 Press MENU and select SMARTFILE EDIT.

The SMARTFILE EDIT menu appears.

SMARTFILE EDIT	p. 1
8/10/98-8/16/98	
Someday	8 / 16
DRAMA	0H30M SP
Nick & Matt	8 / 13
COMEDY	0H50M SP
Rock Box	8 / 10
MUSIC	0H30M EP
SELECT : <input type="text"/>	QUIT : MENU
CATEGORY : <input type="text"/>	TITLE : <input type="text"/>

4 Push the cursor stick to ↑ to select the tape title.

SMARTFILE EDIT	p. 1
8/10/98-8/16/98	
Someday	8 / 16
DRAMA	0H30M SP
Nick & Matt	8 / 13
COMEDY	0H50M SP
Rock Box	8 / 10
MUSIC	0H30M EP
SELECT : <input type="text"/>	QUIT : MENU
TITLE EDIT	: <input type="text"/>

5 Push the cursor stick to →.

The cursor moves to the tape title input position.

SMARTFILE EDIT	p. 1
Someday	8 / 16
DRAMA	0H30M SP
Nick & Matt	8 / 13
COMEDY	0H50M SP
Rock Box	8 / 10
MUSIC	0H30M EP
SELECT : <input type="text"/>	CONFIRM : OK
BACK : <input type="text"/>	NEXT : <input type="text"/>

6 Label the tape.

- 1 Push the cursor stick to \uparrow/\downarrow to select a character.

Each time you push the cursor stick to \downarrow , the character changes as shown below.

A \rightarrow B \rightarrow ... \rightarrow Z \rightarrow symbol \rightarrow 0 \rightarrow

1 \rightarrow ... \rightarrow 9 \rightarrow a \rightarrow b \rightarrow ... \rightarrow z \rightarrow

(blank space)

If you make a mistake, press CLEAR.

- 2 To set the next character, push the cursor stick to \rightarrow .

The cursor moves to the next position.

- 3 Repeat steps 1 and 2 to label the tape.

7 Press the cursor stick (OK).

The tape title is stored.

8 Press MENU.

The menu disappears.

To erase the tape title

Press CLEAR after step 4 above. The tape title is erased and the initial and latest dates of use for this tape reappear. If you want to erase these dates from the tape title column, press CLEAR again.

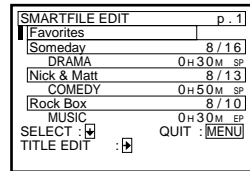
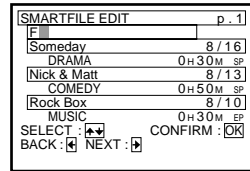
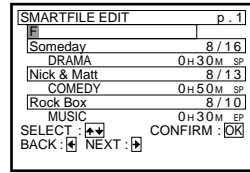

Protecting a recorded program

You can protect a recorded program using the SmartFile function from accidental over-recording or erasure. When you start recording from a position prior to the protected program, the recording stops automatically before the protected program.

Before you start...

- Turn on your TV and set it to the video channel.

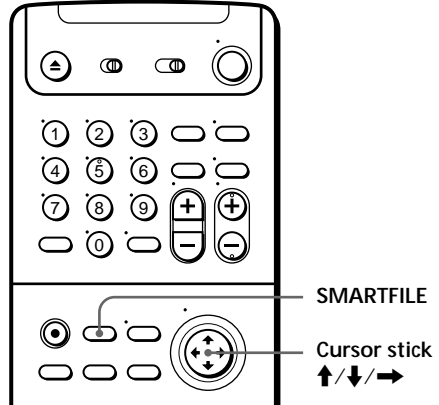

- 1** Insert a SmartFile tape.

The VCR turns on, the SMARTFILE indicator lights up, and the SmartFile search list automatically appears on the TV screen.

If the SmartFile tape is already inserted, press SMARTFILE.
- 2** Push the cursor stick to **↑/↓** to select the program you want to protect.
- 3** Push the cursor stick to **→**.

The **🔒** indicator appears to the left of the selected program and the program becomes protected.
- 4** Press SMARTFILE.

The SmartFile search list disappears.

8/10/98-8/16/98	p. 1
▶ BLANK TIME	EP 1H 48M
SUN 6:30PM CH 16	8/16
	0H 30M SP
THU 8:00PM CH 12	8/13
	0H 50M SP
MON 2:30PM CH 8	8/10
	0H 30M EP
START	END

8/10/98-8/16/98	p. 1
BLANK TIME	EP 1H 48M
SUN 6:30PM CH 16	8/16
	0H 30M SP
▶ THU 8:00PM CH 12	8/13
	0H 50M SP
MON 2:30PM CH 8	8/10
	0H 30M EP
START	END

8/10/98-8/16/98	p. 1
BLANK TIME	EP 1H 48M
SUN 6:30PM CH 16	8/16
	0H 30M SP
▶ THU 8:00PM CH 12	8/13
🔒	0H 50M SP
MON 2:30PM CH 8	8/10
	0H 30M EP
START	END

To unlock the protected program

Push the cursor stick to ← in step 4 above. The  indicator disappears and you can record over this program.

Tips

- When you start recording from a position prior to the protected program, the recording automatically stops no more than about three minutes in SP mode and about eight minutes in EP mode before the beginning of the protected program.
- If you protect a program just after the Blank Time space, BLANK TIME becomes shortened by about three minutes in SP mode and by about eight minutes in EP mode.
- If you try to record on a SmartFile tape containing a protected program, a message indicating that there is a protected program on this tape appears on the TV screen.

Notes

- When you record another program just after a protected program, locate the beginning of the Blank Time space by following the instructions in “Recording after locating the Blank Time space” on page 43. Otherwise, if the recording start point overlaps the protected program, the VCR may over-record the protected program.
- If the VCR Plus+, GUIDE Plus+, or manual timer setting overlaps the protected program, the VCR automatically stops recording before the protected program and ejects the tape.
- If you insert a SmartFile tape which contains a protected program or protect a program for the first time on a new tape, the VCR will analyze the position of the protected program for a few seconds. You cannot operate the VCR while the VCR is analyzing the tape.
- If the SmartFile list contains 12 protected programs, the next program you record won't be stored in the SmartFile list.

Erasing the data of an unwanted program

You can erase an unwanted program from the SmartFile list. When you erase a program from the list, that portion of tape is subject to Blank Time space priority.

Before you start...

- Turn on your TV and set it to the video channel.

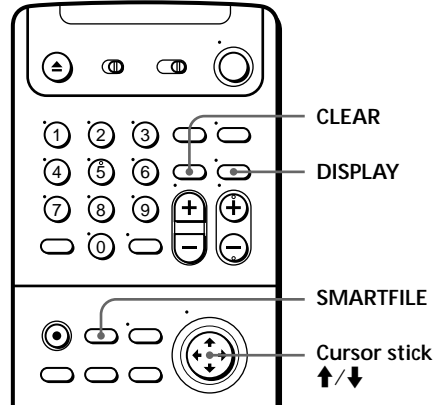

1 Insert a SmartFile tape.

The VCR turns on, the SMARTFILE indicator lights up, and the SmartFile search list automatically appears on the TV screen.

If the SmartFile tape is already inserted, press SMARTFILE.

8/10/98-8/16/98	p. 1
BLANK TIME	EP 1H48M
SUN 6:30PM CH 16	8/16 0H30M SP
THU 8:00PM CH 12	8/13 0H50M SP
MON 2:30PM CH 8	8/10 0H30M EP
START . . .	END

2 Push the cursor stick to ↑/↓ to select a program you want to erase from the list.

8/10/98-8/16/98	p. 1
BLANK TIME	EP 1H48M
SUN 6:30PM CH 16	8/16 0H30M SP
▶THU 8:00PM CH 12	8/13 0H50M SP
MON 2:30PM CH 8	8/10 0H30M EP
START . . .	END

3 Press CLEAR.

The selected program is erased from the SmartFile list.

If you erase a program by mistake, press DISPLAY to make the program reappear.

8/10/98-8/16/98	p. 1
BLANK TIME	EP 2H30M
SUN 6:30PM CH 16	8/16 0H30M SP
▶MON 2:30PM CH 8	8/10 0H30M EP
START . . .	END

4 Press SMARTFILE.

The SmartFile search list disappears.

Notes

- You cannot erase a protected program from the SmartFile list. You have to first unlock the protected program by following the instructions in “To unlock the protected program” on page 53, then erase that program from the list.
- If a program is left about 15 minutes or less in EP mode, or about 5 minutes or less in SP mode, you cannot make the program reappear by using the DISPLAY button.

Storing program data from the DSS receiver (Program Data Download)

If you connect a DSS receiver equipped with the Program Data Download function and use the timer recording of the DSS receiver, the program and category name transmitted from the DSS are stored on the SmartFile tape. The DSS receiver equipped with the Data Download function will be available in the future.

How to hook up to the DSS receiver

You should connect CPD IN of the VCR and VCR CONTROL of the DSS receiver using the supplied monaural cable.

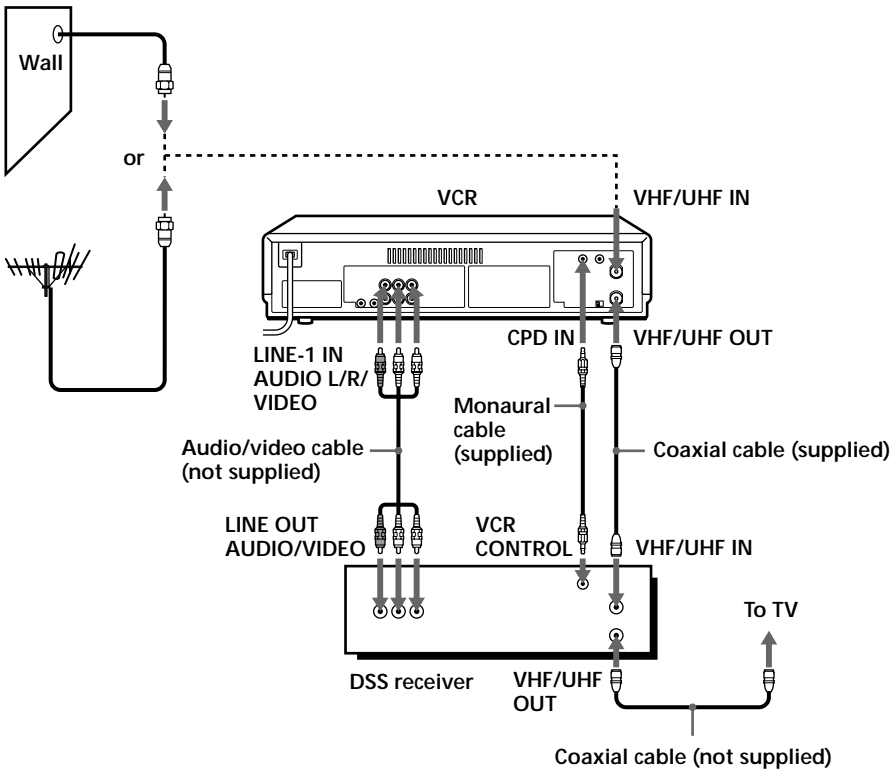

continued

Storing program data from the DSS receiver (Program Data Download) (continued)

Setting up the DSS receiver

You have to set the VCR brand number on the DSS receiver. For example, select “99” in the VCR CONTROL menu to use a Sony VCR with the SmartFile function. For details, refer to the instruction manual of your DSS receiver.

Storing program data on the SmartFile tape

When you record a DSS program using the DSS receiver’s timer, the program and category name are automatically stored on the SmartFile tape.

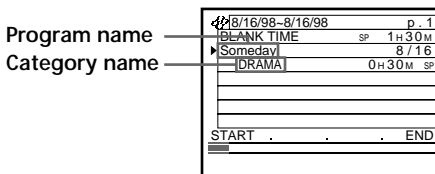

Notes

- Do not operate the VCR, the DSS receiver, and any other equipment connected to these units for at least two minutes after timer recording starts. If you operate these equipment immediately after timer recording starts, the correct program data may not be sent from the DSS receiver.
- When you use the VCR’s timer for recording, program data from the DSS receiver is not stored on the SmartFile tape.

About the GUIDE Plus+ system

The GUIDE Plus+ system can display a two-day on-screen program list (transmitted from certain TV stations) on the TV screen. You can select the program you want to record from this program list.

You need to use the on-screen menus to use the GUIDE Plus+ system. Learn how to select the GUIDE Plus+ on-screen menus before you use the GUIDE Plus+ system.

Learning the menu

Press GUIDE to enter the GUIDE Plus+ on-screen menu, then navigate with the cursor stick, blue and green colored buttons.

Before you start...

- Turn on your TV and set it to the video channel.

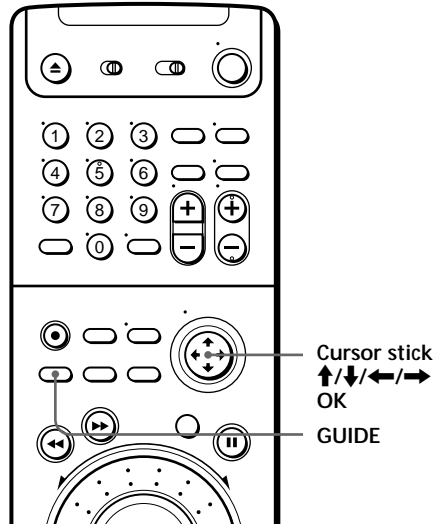

1 Press GUIDE.

The Grid menu appears on the TV screen with the Grid column highlighted on the menu bar. The cursor is the top item of the Grid menu.

If the program information signal in your area has several channel map patterns, the Channel map selection menu appears the first time you press the GUIDE button. In this case, you have to select the channel map on the Channel map selection menu. See “To select the channel map” on page 59.

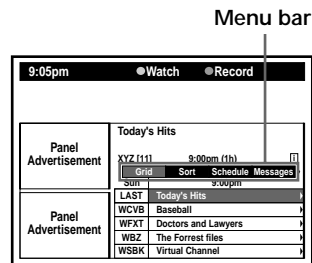

continued

About the GUIDE Plus+ system (continued)

- 2 Push the cursor stick to **↑**.
The cursor moves to the menu bar.

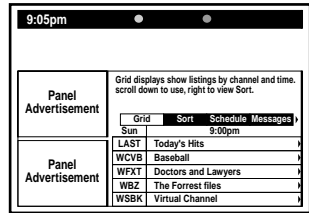

- 3 Push the cursor stick to **←/→** to select the menu you want to display.
The selected menu appears on the TV screen.

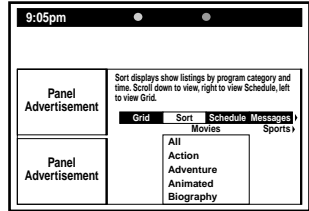

To select an item

- 1 After selecting the menu, push the cursor stick to **↓**.
The cursor moves to the top item.

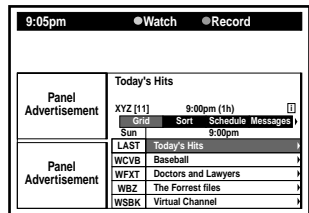

- 2 Push the cursor stick to **↑/↓/←/→** to select the item you want.

The cursor stick's **←/→** work only when there are items on the right and left.

If timer setting or other operations are available for the selected item, the names of the operations appear next to the blue or green button indications.

Green button indication

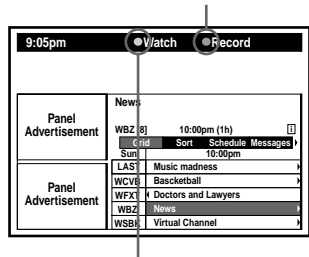

Blue button indication

To close the menu
Press GUIDE.

To select the channel map

If the program information signal in your area has several channel map patterns, the Channel map selection menu appears on the TV screen. In this case, you have to select the channel map on the Channel map selection menu.

- 1 Push the cursor stick to **←/→** to select the channel map you want.
- 2 Press the cursor stick (OK).

The next program listing data transmission start time appears in the Grid menu.

- 3 Turn off the VCR.

Whenever the VCR is turned off, it is in data receiving standby mode, and will receive the program listing once per day.

If you set the wrong channel map, select the correct channel map following the steps below.

- 1 To clear the wrong channel map data, enter your ZIP/POSTAL CODE but change the last digit to another number which is different than the one for your area, then set it using the EASY SET UP.

- 2 Enter the correct ZIP POSTAL CODE for your area, then set it again using the EASY SET UP.

When the EASY SET UP finishes, wait until the VCR receives the GUIDE Plus+ program listing.

- 3 Press GUIDE, then select the correct channel map following the steps in “To select the channel map” again.

Notes

- If no programs appear on the program listing, the VCR hasn't received the GUIDE Plus+ data. To receive the GUIDE Plus+ program listing on a daily basis, be sure to turn off the VCR when not in use. Whenever the VCR is turned off, it is in data receiving standby mode, and will receive the program listing once per day. Select “No listing” on the Grid menu's program list to see the next data transmission start time. In most cases, it takes about two hours to download the data.
- The GUIDE Plus+ menu is displayed only in English; therefore, even if you select French or Spanish on the LANGUAGE menu, the GUIDE Plus+ menu appears only in English.
- You cannot display the GUIDE Plus+ menu when you press the GUIDE button if:
 - you display any other menu.
 - the VCR is in recording mode.
 - the VCR is in playback mode.

Overview of the GUIDE Plus+ menu

The GUIDE Plus+ system has six menus. See below for a summary of each menu. For details about the operations for each menu, see the pages listed next to each menu title.

Grid menu (page 62)

You can view the program listings of up to 50 channels for the current time and on through midnight of the next day. After viewing the information about the programs, select the program you want to watch or record.

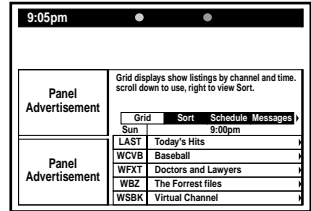

Sort menu (page 67)

You can search for a program by category, such as Movies or Sports. Programs for up to the next eight days appear in the menu. After viewing the information about the programs, select the program you want to watch or record.

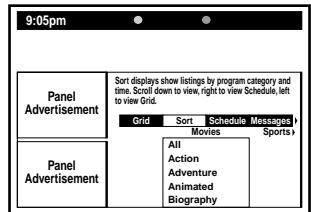

Schedule menu (page 70)

You can check and make changes to the recording or viewing schedule set on the Grid menu, Sort menu, or VCR Plus+. Use this menu to change the recording pattern (Once, Daily, Weekly) and tape speed. You can set VCR Plus+ recordings using the PlusCode on this menu.

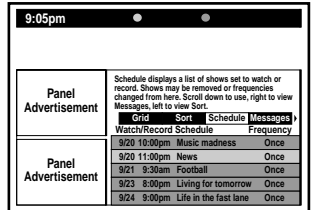

Editor menu (page 74)

You can select which channels to display on the Grid menu's program list.

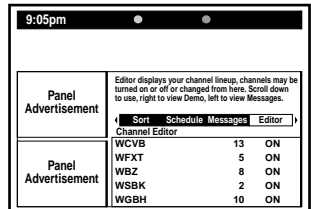

Messages menu

This menu is provided exclusively for service and repair personnel and is not intended for use during normal operation.

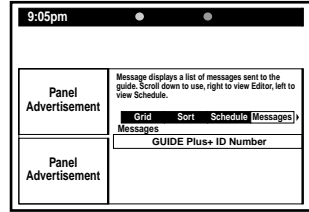

Demo menu (page 76)

You can practice operating the menu using the GUIDE Plus+ demonstration function.

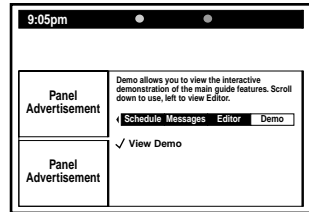

Using the Grid menu

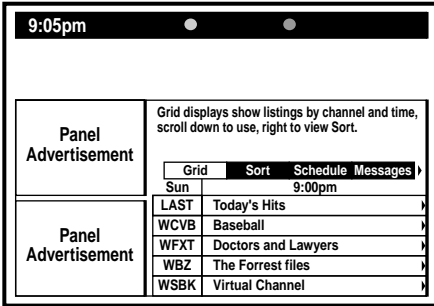

You can view the program listing for the current time and on through midnight of the next day using the Grid menu. The program list contains up to 50 channels. You can set the GUIDE Plus+ timer for recording and/or viewing on the program list for up to 20 programs at one time.

To display the Grid menu, select Grid on the menu bar. See “Learning the menu” on page 57 for more information about the menu.

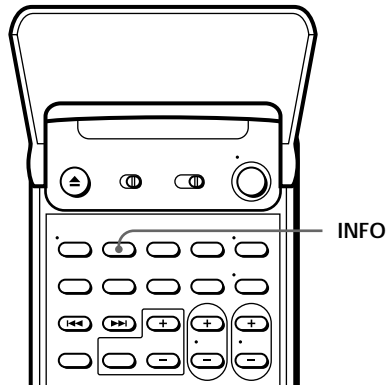
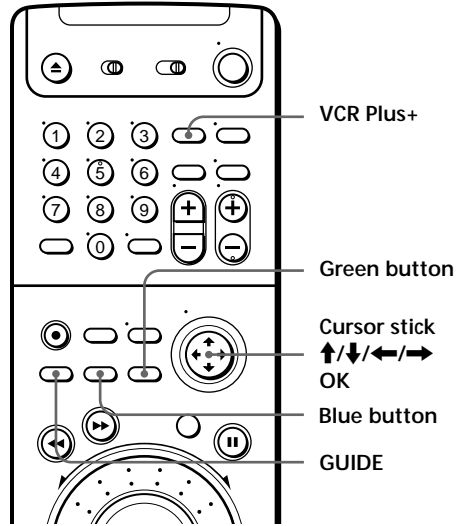

Getting information about a program

You can get information about a current or future program you want to watch or record. The program you were watching before using the GUIDE Plus+ menu is displayed in gray.

Select a program using the cursor stick (↑/↓/←/→). Basic information about the program appears in the information box.

Tip

- If **i** is displayed in the information box, you can receive detailed information about that program and view the program's channel listing by pressing the INFO button. You can set the GUIDE Plus+ timer to record by pressing the green (Record) button, or to view by pressing the blue (Watch) button.

To go back to the Grid menu, press INFO.

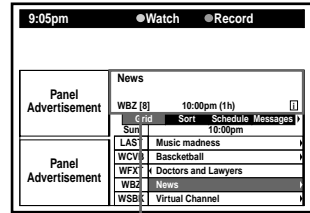

Information box

Note

- If no programs appear on the program listing, the VCR hasn't received the GUIDE Plus+ data. To receive the GUIDE Plus+ program listing on a daily basis, be sure to turn off the VCR when not in use. Whenever the VCR is turned off, it is in data receiving standby mode, and will receive the program listing once per day. Select "No listing" on the Grid menu's program list to see the next data transmission start time. In most cases, it takes about two hours to download the data.

Watching a program

Push the cursor stick to **↑/↓/←/→** to select a currently broadcast program which you want to watch, then press the cursor stick (OK). The Grid menu disappears and you can watch the selected program.

continued

Setting the GUIDE Plus+ timer to record

Push the cursor stick to **↑/↓/←/→** to select the program you want to record, then press the green (Record) or VCR Plus+ button.

The selected program listing turns red, and the VCR is set to record this program in EP mode. Insert a tape with its safety tab in place and turn off the VCR before recording starts.

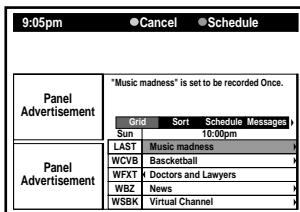

Tips

- You can cancel the GUIDE Plus+ timer settings, change the recording pattern (Once, Daily, or Weekly), and change the tape speed by using the Schedule menu (page 71). When you select a program for recording and press the green (Schedule) button, you will go to the Schedule menu.
- You can cancel the GUIDE Plus+ timer settings if you make a mistake by pressing the blue (Cancel) button. However, you cannot cancel timer settings on the Grid menu after you move the cursor to other programs.
- When you set the GUIDE Plus+ timer to record the program currently being broadcast, the VCR starts recording that program in the tape speed selected on the VCR.
- When you record a program on a SmartFile tape using the GUIDE Plus+ timer, the program and category name are automatically stored on the SmartFile list (page 41).

Setting the GUIDE Plus+ timer for viewing

Push the cursor stick to **↑/↓/←/→** to select the program you want to watch, then press the blue (Watch) button.

The selected program listing turns orange, and the VCR is placed in viewing timer standby mode. When the preset program begins, the VCR automatically turns on and sets the channel to the selected program's channel.

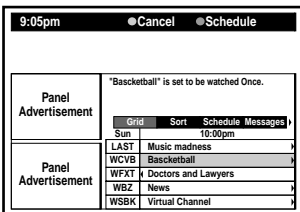

Tips

- You can cancel the GUIDE Plus+ timer settings and change the viewing pattern (Once, Daily, or Weekly) by using the Schedule menu (page 71). When you select a program for viewing and press the green (Schedule) button, you will go to the Schedule menu.
- You can cancel the GUIDE Plus+ timer settings if you make a mistake by pressing the blue (Cancel) button. However, you cannot cancel timer settings on the Grid menu after you move the cursor to other programs.
- Whenever the VCR is automatically turned on by the preset GUIDE Plus+ timer viewing function, the VCR automatically turns off after the preset program finishes. However, if you press any button while viewing the program, the VCR will not automatically turn off.

Viewing advertisements

GUIDE Plus+ has two different types of advertisements; a panel advertisement and a virtual channel advertisement. You can view detailed information about these advertisements and set the GUIDE Plus+ timer to record or view these programs.

To view a panel advertisement

All menus have a panel advertisement.

Push the cursor stick to **←** repeatedly until the panel advertisement is selected. When the cursor is on the menu bar, push the cursor stick to **↓** to move the cursor to the top item, then push the cursor stick to **←** repeatedly.

Detailed information about the panel advertisement appears. To go back to the original menu, push the cursor stick to **→**.

Tips

- You can set the GUIDE Plus+ timer to record that program by pressing the green (Record) button, or to view that program by pressing the blue (Watch) button.
- If there is no panel advertisement on the menu, you can view “Overview of the GUIDE Plus+ features” or “Getting Started Tips.”

To view a virtual channel advertisement

The virtual channel advertisement is in the program list.

Push the cursor stick to **↑/↓** to select the virtual channel advertisement, then press INFO.

Detailed information about the virtual channel advertisement appears. To go back to the original menu, press INFO.

Tip

- You can set the GUIDE Plus+ timer to record that program by pressing the green (Record) button, or to view that program by pressing the blue (Watch) button.

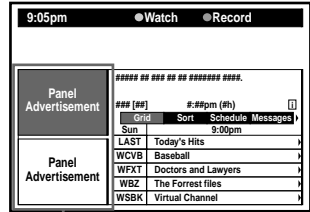

Panel advertisement

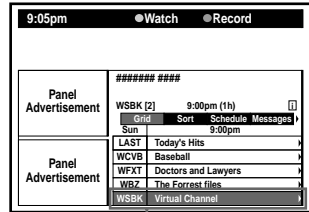

Virtual channel advertisement

continued

Using the Grid menu (continued)

Locking the channel behind the menu

As you select programs using the cursor stick (↑/↓/←/→), every time the cursor shifts, the program behind the menu changes as well. If you want to display the same channel behind the menu, you can set it so that one channel is locked-in behind the menu regardless of cursor movements.

- 1 Push the cursor stick to ← repeatedly until the channel column is selected.
- 2 Push the cursor stick to ↑/↓ to select the channel you want to lock-in.

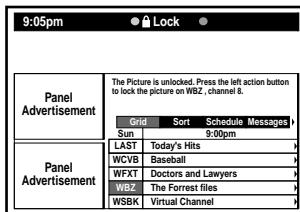

- 3 Press the blue (Lock) button.
🔒 appears and the selected channel is locked-in.
To unlock, press the blue (Unlock) button in step 3.

Closing the menu

Press GUIDE.

Note

- If no programs appear on the program listing, the VCR hasn't received the GUIDE Plus+ data. To receive the GUIDE Plus+ program listing on a daily basis, be sure to turn off the VCR when not in use. Whenever the VCR is turned off, it is in data receiving standby mode, and will receive the program listing once per day. Select "No listing" on the Grid menu's program list to see the next data transmission start time. In most cases, it takes about two hours to download the data.

Using the Sort menu

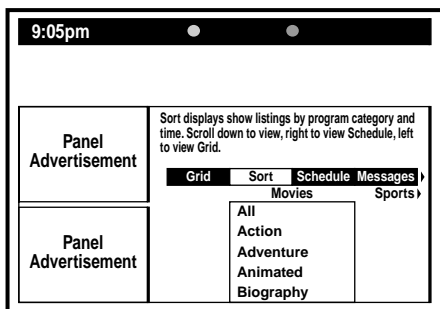

You can display the program listings for the next eight days in the Sort menu according to category (movie, sports, etc.). Use this menu when you want to search for a program by category. You can set the GUIDE Plus+ timer for recording and/or viewing on the program list for up to 20 programs at one time.

To display the Sort menu, select Sort on the menu bar. See “Learning the menu” on page 57 for more information about the menu.

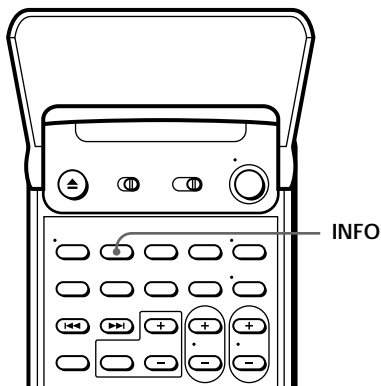
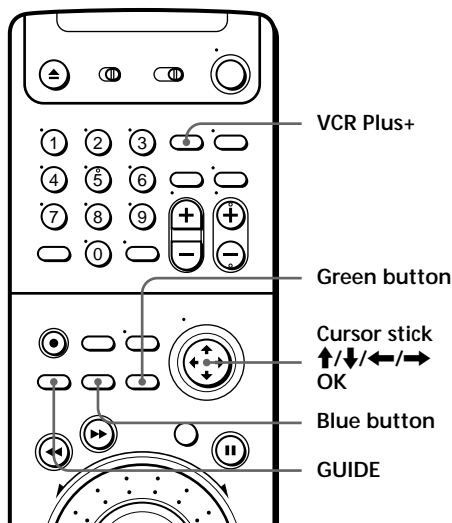

Viewing the program list by category

- 1 Push the cursor stick to \leftarrow/\rightarrow to select the category you want.

When the cursor is on the menu bar, push the cursor stick to \downarrow , then push the cursor stick to \leftarrow/\rightarrow to select the category.

continued

Using the Sort menu (continued)

- 2 Push the cursor stick to **↑/↓** to select the subcategory you want, then press the cursor stick (OK).

The program listing sorted by the selected category and subcategory appears.

Panel Advertisement	Baseball
	WCVB (13) 9:00pm (1h)
	Grid Sort Schedule Messages
	Sports: All Sun, September 20
Panel Advertisement	Baseball
	WCVB Baseball 9:00pm
	WFXT College Football 9:00pm
	WBZ Auto Racing 9:00pm
	WSBK Basketball 10:00pm
	WGBH Triathlon 3:30am

- 3 Push the cursor stick to **↑/↓** to select the program you want.

Information about the program appears in the information box.

If **i** is displayed in the information box, you can receive detailed information about that program and view the program's channel listing by pressing the INFO button. You can set the GUIDE Plus+ timer to record by pressing the green (Record) button, or to view by pressing the blue (Watch) button.

To go back to the program list, press INFO.

To select another category, push the cursor stick to **↑** to select Sort on the menu bar, then press the cursor stick (OK). Repeat from step 1.

Tip

- After selecting a program on the Sort menu's program list, by pushing the cursor stick to **←/→**, you can select the preceding or succeeding day's same time broadcast program.

Setting the GUIDE Plus+ timer to record

You can preset the timer to record a program on the program list.

Push the cursor stick to **↑/↓/←/→** to select the program you want to record, then press the green (Record) or VCR Plus+ button.

The selected program listing turns red, and the VCR is set to record this program in EP mode. Insert a tape with its safety tab in place and turn off the VCR before recording starts.

Panel Advertisement	"Triathlon" is set to be recorded Once.
	Grid Sort Schedule Messages
	Sports: All Sun, September 20
Panel Advertisement	Baseball
	WCVB Baseball 9:00pm
	WFXT College Football 9:00pm
	WBZ Auto Racing 9:00pm
	WSBK Basketball 10:00pm
	WGBH Triathlon 3:30am

Tips

- You can cancel the GUIDE Plus+ timer settings, change the recording pattern (Once, Daily, or Weekly), and change the tape speed by using the Schedule menu (page 71). When you select a program for recording and press the green (Schedule) button, you will go to the Schedule menu.
- You can cancel the GUIDE Plus+ timer settings if you make a mistake by pressing the blue (Cancel) button. However, you cannot cancel timer settings on the Sort menu after you move the cursor to other programs.
- When you set the GUIDE Plus+ timer to record the program currently being broadcast, the VCR starts recording that program in the tape speed selected on the VCR.
- When you record a program on a SmartFile tape using the GUIDE Plus+ timer, the program and category name are automatically stored on the SmartFile list (page 41).

Setting the GUIDE Plus+ timer for viewing

Display the program list, push the cursor stick to \uparrow/\downarrow to select the program you want to watch, then press the blue (Watch) button.

The selected program listing turns orange, and the VCR is placed in viewing timer standby mode. When the preset program begins, the VCR automatically turns on and sets the channel to the selected program's channel.

9:05pm ●Cancel ●Schedule			
Panel Advertisement			
"Basketball" is set to be watched Once.			
Sports: All Sun, September 20			
Grid	Sort	Schedule	Messages
WCVE	Baseball	9:00pm	
WFXT	College Football	9:00pm	
WBZ	Auto Racing	9:00pm	
WSBK	Basketball	10:00pm	
WGBH	Triathlon	3:30am	

Tips

- You can cancel the GUIDE Plus+ timer settings and change the viewing pattern (Once, Daily, or Weekly) by using the Schedule menu (page 71). When you select a program for viewing and press the green (Schedule) button, you will go to the Schedule menu.
- You can cancel the GUIDE Plus+ timer settings if you make a mistake by pressing the blue (Cancel) button. However, you cannot cancel timer settings on the Sort menu after you move the cursor to other programs.
- Whenever the VCR is automatically turned on by the preset GUIDE Plus+ timer viewing function, the VCR automatically turns off after the preset program finishes. However, if you press any button while viewing the program, the VCR will not automatically turn off.

Closing the menu

Press GUIDE.

Using the Schedule menu

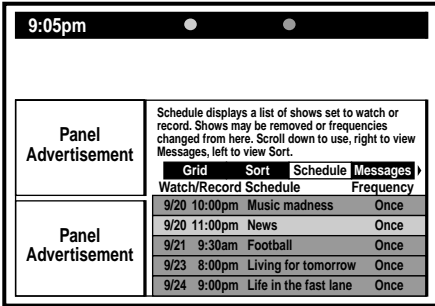

You can check the GUIDE Plus+ programs scheduled to record or be viewed in the Schedule menu. You can change the recording and/or viewing pattern (Once, Daily, or Weekly), change the recording speed, and cancel recordings and/or viewings. You can also use PlusCode to preset the VCR Plus+ recording schedule with this menu.

To display the Schedule menu, select Schedule on the menu bar. See “Learning the menu” on page 57 for more information about the menu.

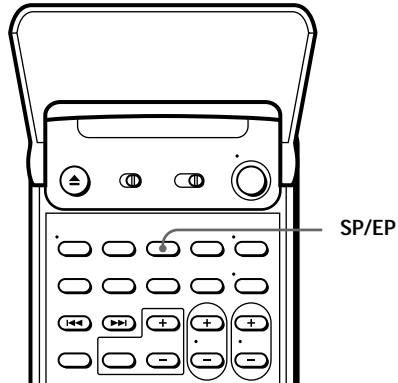
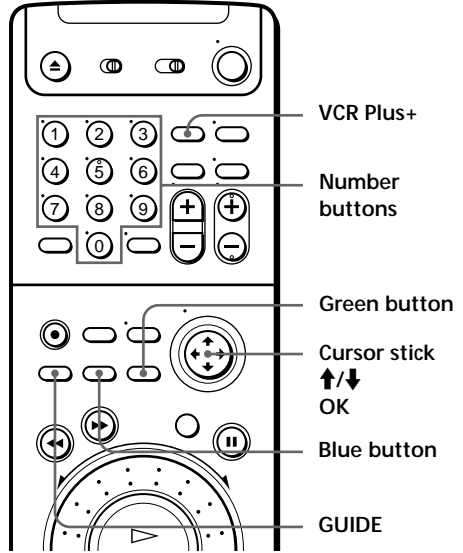

Checking the VCR Plus+ and GUIDE Plus+ recording or viewing schedule

Push the cursor stick to ↑/↓ to find the preset programs.

Programs set to record are displayed in red, and programs set to be viewed are displayed in orange. Information about the selected program appears in the information box.

Changing the VCR Plus+ and GUIDE Plus+ recording or viewing pattern

To change the recording or viewing pattern, first push the cursor stick to **↑**/**↓** to select the program you want to change. Then press the green (Change) button repeatedly to select Once, Daily, or Weekly.

You cannot select Daily or Weekly for a program that airs more than seven days ahead.

Changing the recording speed

To change the recording speed, first push the cursor stick to **↑**/**↓** to select the program you want to change. Then press SP/EP to select the tape speed. The selected tape speed appears in the information box.

Canceling a VCR Plus+ or GUIDE Plus+ recording or viewing schedule

Push the cursor stick to **↑**/**↓** to select the program you want to cancel and press the blue (Remove) button. The selected program is canceled and disappears from the program list on the Schedule menu. If you cancel the program currently recording, the VCR automatically turns off.

Tip

- To stop the current VCR Plus+ or GUIDE Plus+ recording or viewing, select the program you want to stop and press the blue (STOP) button.

continued

Using the Schedule menu (continued)

Recording TV programs using VCR Plus+

You can set a future program which isn't on the GUIDE Plus+ list yet by using the PlusCode feature of VCR Plus+. For details about VCR Plus+, see "How VCR Plus+ works" on page 12.

- 1 Press VCR Plus+.
The Enter Pluscode screen appears.

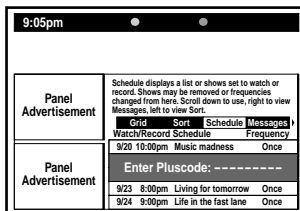

- 2 Press the number buttons to enter the program's PlusCode.
If you make a mistake, press VCR Plus+ twice and re-enter the correct number.
- 3 Press the cursor stick (OK).
The selected program is added to the list, and VCR is set to record this program in EP mode. Insert a tape with its safety tab in place and turn off the VCR before recording starts.

Tip

- You can cancel the VCR Plus+ timer settings, change the recording pattern (Once, Daily, or Weekly), and change the tape speed by using the Schedule menu (page 71).

Note

- You cannot operate the Schedule menu while the Enter Pluscode screen is displayed on the TV screen. To close the Enter Pluscode screen, press VCR Plus+ button.

Closing the menu

Press GUIDE.

When the manual timer setting and the GUIDE Plus+ timer setting overlap

When the manual timer setting and the GUIDE Plus+ timer setting (including VCR Plus+ recording) overlap, the GUIDE Plus+ timer setting has priority. If you want to make more than one timer setting at one time, we recommend that you use the same timer setting method at that time for all timer settings, either the GUIDE Plus+ timer or the manual timer setting.

- If the recording stop time of the GUIDE Plus+ timer setting and the recording start time of the manual timer setting are set at the same time, the manual timer setting is canceled.

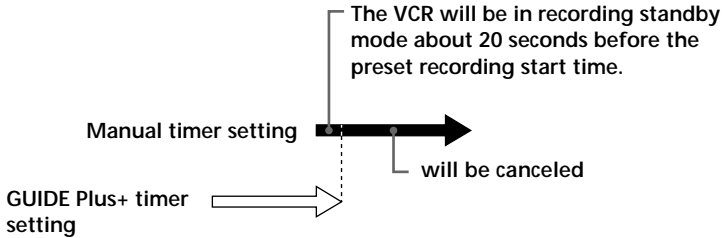

- If the manual timer setting and GUIDE Plus+ timer setting are scheduled to start at the same time, the VCR starts recording the program preset with the GUIDE Plus+ timer.
- If the GUIDE Plus+ timer setting is scheduled to start while the VCR is already recording a manual timer setting, the VCR stops recording the manual timer setting and starts recording the GUIDE Plus+ timer setting. If the recording stop time of the manual timer setting and the recording start time of the GUIDE Plus+ timer setting are set at the same time, the VCR stops recording of the manual timer setting about two minutes before the preset stop time.

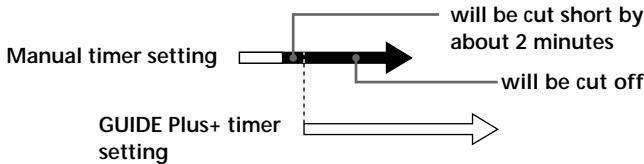

- If a manual timer setting is scheduled to start while the VCR is recording the GUIDE Plus+ timer setting, the manual timer setting is canceled.

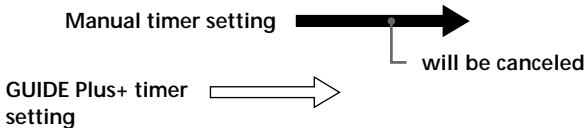

Note

- You cannot change the date, recording start and stop time, or channel of the GUIDE Plus+ timer setting after the recording schedule has been set. To make a correction, you need to cancel the GUIDE Plus+ timer setting and reset it from the beginning.

Using the Editor menu

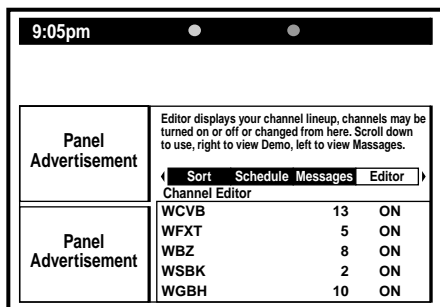

You can select the channels to be displayed on the Grid menu's program list using the Editor menu. You can display up to 50 channels on the program list. The channels are displayed in the order of the Editor menu channels. You cannot change the channel order. Customize your program list by selecting ON or OFF for each channel in the Editor menu.

To display the Editor menu, select Editor on the menu bar. See "Learning the menu" on page 57 for more information about the menu.

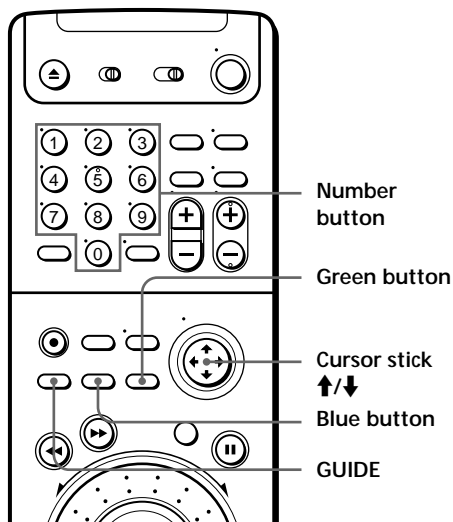

Selecting the channels to be displayed on the program list

Push the cursor stick to \uparrow/\downarrow to select the channel you want to hide or show. To display the channel on the program list, press the green (On/Off) button to select ON. To hide the channel, press the green (On/Off) button to select OFF.

Canceling a selected display setting

Push the cursor stick to \uparrow/\downarrow to select the channel you want to cancel. Then, press the blue (Cancel) button. The display setting (ON or OFF) is reset to its previous state. Once you close the Editor menu, you cannot cancel the display setting using this method. Use the above method "Selecting the channels to be displayed on the program list" instead.

Changing channel numbers

Push the cursor stick to **↑/↓** to select the channel you want to change. Using the number buttons, enter the new channel number which you want to assign to that station. The TV stations in your area appear in the channel list. Note, however, that depending on your connection type, you may not be able to receive certain broadcast stations.

Note

- When changing channel numbers, be careful not to set the same channel number to two or more different broadcast stations.

Closing the menu

Press **GUIDE**.

Using the Demo menu

You can see a demonstration of the various menu operations of the GUIDE Plus+ system. Even if the VCR hasn't received the program list data of GUIDE Plus+, you can practice operating the GUIDE Plus+ system using this menu.

To display the Demo menu, select Demo on the menu bar. See "Learning the menu" on page 57 for more information about the menu.

Push the cursor stick to ↓ to select "✓ View Demo," then press the cursor stick (OK). The demonstration starts. If the VCR has received GUIDE Plus+ program list data, the demonstration will use the actual program list.

To stop a demonstration

Press GUIDE. The demonstration stops and the menu disappears.

Note

- If you use the cursor stick (↑/↓/←/→) during a demonstration, a different menu appears on the TV screen. However, the demonstration doesn't finish unless you press the GUIDE button and close the menu.

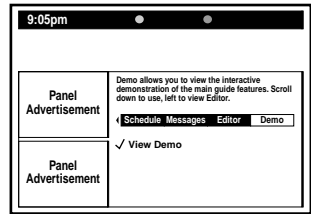

Troubleshooting

If you have any questions or problems not covered below, please consult your nearest Sony dealer.

	Symptom	Remedy
Power	The POWER switch does not function.	<ul style="list-style-type: none"> • Connect the AC power cord securely. • Make sure the VCR is not locked. To unlock, hold POWER down on the VCR until  indicator disappears.
	The power is turned on but the VCR does not operate.	<ul style="list-style-type: none"> • Moisture condensation occurs. Turn the power off, unplug the AC power cord and leave the VCR to dry for over an hour.
Clock	The clock has stopped and “-:--” lights in the display window.	<ul style="list-style-type: none"> • The clock stops if the VCR is disconnected from the wall outlet for more than one hour. Reset the clock (and timer).
Playback	The playback picture does not appear on the TV screen.	<ul style="list-style-type: none"> • Make sure the TV is set to the channel for the VCR. If you are using a monitor, set it to video input.
	The picture is not clear.	<ul style="list-style-type: none"> • Adjust the tracking with the TRACKING +/- buttons. • The video heads are dirty (see below). Clean the video heads using the Sony T-25CLD, T-25CLDR, or T-25CLW video head cleaning cassette. If these cleaning cassettes are not available in your area, have the heads cleaned at your nearest Sony dealer (a standard service charge will be required). Do not use a commercially available liquid type cleaning cassette other than Sony's, as they may damage the video heads. • The video heads may have to be replaced. Consult your local Sony dealer for more information.
	The picture rolls vertically during picture search.	<ul style="list-style-type: none"> • Adjust the vertical hold control on the TV or monitor.
	The picture has no sound.	<ul style="list-style-type: none"> • The tape is defective. • If you made A/V connections, check the audio cable connection.

Symptoms caused by contaminated video heads

- Normal picture
- Rough picture
- Unclear picture
- No picture (or black & white screen appears)



initial contamination



terminal

continued

Troubleshooting (continued)

	Symptom	Remedy
Recording	A TV program does not appear on the TV screen.	<ul style="list-style-type: none"> • Make sure the TV is set to the channel for the VCR. If you are using a monitor, set it to video input.
	TV reception is poor.	<ul style="list-style-type: none"> • Adjust the TV antenna.
	The tape starts playing as soon as it is inserted.	<ul style="list-style-type: none"> • The safety tab has been removed. To record on this tape, cover the tab hole.
	The tape is ejected when you press ● REC.	<ul style="list-style-type: none"> • Check that the safety tab has not been removed.
	Nothing happens when you press ● REC.	<ul style="list-style-type: none"> • Make sure the tape is not at its end. • Select the correct source with the INPUT SELECT button. Select a channel number when recording TV programs; select "L1" or "L2" when recording from other equipment. • The current position of the tape is record protected. Search for the recording available space.
	Recording stops halfway.	<ul style="list-style-type: none"> • If the tape contains a protected program, recording automatically stops before the protected program. Use another tape which has enough recording space.
Timer recording	The timer does not operate.	<ul style="list-style-type: none"> • Check that the clock is set. • Make sure a tape has been inserted. • Check that the safety tab has not been removed. • Make sure the tape is not at its end. • The recording start point overlaps the protected program. • Make sure a program has been set for timer recording. • Make sure your timer settings have not already passed the current time. • Check that the cable box is turned on. • The clock stops if the VCR is disconnected from the wall outlet for more than one hour. Reset the clock and timer. • When you use cable box control, make sure the CABLE BOX CONTROL option is set to ON.

	Symptom	Remedy
GUIDE Plus+	The Grid menu doesn't appear on the TV screen when you press GUIDE.	<ul style="list-style-type: none"> • If using a cable box, check that it is turned on. • Make sure the TV is set to the channel for the VCR. If you are using a monitor, set it to video input. • Check that the VCR is in stop mode.
	The program listing data disappeared from the program list.	<ul style="list-style-type: none"> • A power cut occurred or the VCR was disconnected from the wall outlet for more than one hour. Turn off the VCR so that the VCR can receive the program listing data.
	The VCR has not received the program listing data.	<ul style="list-style-type: none"> • Turn off the VCR. The next data transmission start time appears in the information box of the Grid menu.
	The GUIDE Plus+ or VCR Plus+ timer recording program does not record, or timer recording stops halfway.	<ul style="list-style-type: none"> • A power cut occurred during the timer recording.
Others	A tape cannot be inserted.	<ul style="list-style-type: none"> • Check that a tape isn't already in the tape compartment.
	The remote commander does not function.	<ul style="list-style-type: none"> • Make sure you are pointing the remote commander at the remote sensor on the VCR. • Replace all the batteries in the remote commander with new ones if they are weak. • If you are not using S-Link™, make sure that both miniplugs are unconnected. • The command mode of the remote commander is different from the one of the VCR.
	The channels on the VCR cannot be changed.	<ul style="list-style-type: none"> • Make sure the CABLE BOX CONTROL option is set to OFF.
	The tracking meter does not appear on the screen.	<ul style="list-style-type: none"> • The recording condition of the tape is very poor and tracking cannot be adjusted.
	You cannot control other TVs.	<ul style="list-style-type: none"> • Set your TV's code number. The code number resets when you replace the batteries of the remote commander.
	The VCR needs to be cleaned.	<ul style="list-style-type: none"> • Clean the cabinet, panel and controls with a dry, soft cloth, or a soft cloth slightly moistened with a mild detergent solution. Do not use any type of solvent, such as alcohol or benzine.

Specifications

System

- Format
 - VHS NTSC standard
- Video recording system
 - Rotary head helical scanning FM system
- Video heads
 - Double azimuth four heads
- Video signal
 - NTSC color, EIA standards
- Tape speed
 - SP: 33.35 mm/s (1³/₈ inches/s)
 - EP: 11.11 mm/s (7/₁₆ inches/s)
 - LP: 16.67 mm/s (11/₁₆ inches/s), playback only
- Maximum recording/playback time
 - 8 hrs. in EP mode (with T-160 tape)
- Fast-forward and rewind time
 - Approx. 3 min. (with T-120 tape)

Tuner section

- Channel coverage
 - VHF 2 to 13
 - UHF 14 to 69
 - CATV A-8 to A-1, A to W, W+1 to W+84
- Antenna
 - 75-ohm antenna terminal for VHF/UHF

Inputs and outputs

- LINE-1 IN and -2 IN
 - VIDEO IN, phono jack (1 each)
 - Input signal: 1 Vp-p, 75 ohms, unbalanced, sync negative
 - AUDIO IN, phono jack (2 each)
 - Input level: 327 mVrms
 - Input impedance: more than 47 kilohms
- LINE OUT
 - VIDEO OUT, phono jack (1)
 - Output signal: 1 Vp-p, 75 ohms, unbalanced, sync negative
 - AUDIO OUT, phono jack (2)
 - Standard output: 327 mVrms
 - Load impedance: 47 kilohms
 - Output impedance: less than 10 kilohms
- S-LINK (CONTROL S IN)
 - Mini jack (1)
- CABLE BOX CONTROL (CONTROL S OUT)
 - Stereo mini jack (plug in power) (1)
- CPD IN
 - Mini jack (1)
- G-Link
 - Mini jack (1)

Timer section

- Clock
 - Quartz locked
- Timer indication
 - 12-hour cycle
- Timer setting
 - 8 programs per month (max.)
- Power back-up
 - Built-in self-charging capacitor
 - Back-up duration: up to 1 hour at a time

General

- Power requirements
 - 120 V AC, 60 Hz
- Power consumption
 - 24 W
- Operating temperature
 - 5 °C to 40 °C (41 °F to 104 °F)
- Storage temperature
 - 20 °C to 60 °C (- 4 °F to 140 °F)
- Dimensions
 - Approx. 430 × 107 × 287 mm (w/h/d)
 - (Approx. 17 × 4¹/₄ × 11³/₈ inches) including projecting parts and controls
- Mass
 - Approx. 4.6 kg (10 lb 2 oz)

Supplied accessories

- Remote commander (1)
- Size AA (R6) batteries (2)
- 75-ohm coaxial cable with F-type connectors (1)
- Audio/video cable (3-phono, 1-mini to 3-phono, 1-mini) (1)
- Monaural cable (1-mini to 1-mini) (1)
- Cable Mouse (cable box controller) (1)
- Jack cover (1)
- SmartFile labels (5)

Design and specifications are subject to change without notice.

Index to parts and controls

Refer to the pages indicated in parentheses () for details.

Front panel

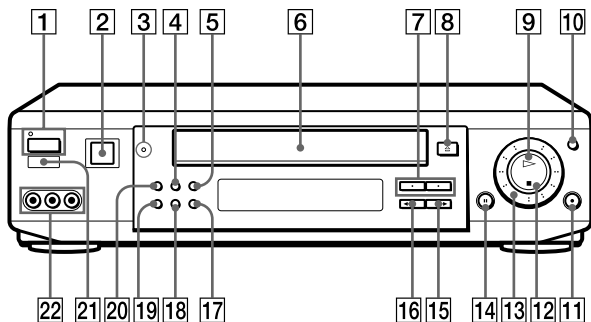

- | | |
|--|--|
| 1 POWER switch/indicator (13, 16) | 12 ■ STOP button (5, 37) |
| 2 SmartFile sensor (46) | 13 Shuttle ring (8, 19) |
| 3 SMARTFILE indicator (41, 46) | 14 ■ PAUSE button (5, 37) |
| 4 INPUT SELECT button (7, 37) | 15 ►► FF (fast forward) button (5, 18, 23) |
| 5 EASY SET UP button | 16 ◀◀ REW (rewind) button (5, 18, 23) |
| 6 Tape compartment | 17 COMMAND MODE button |
| 7 CHANNEL/TRACKING +/- buttons (7, 33) | 18 OK button (44) |
| 8 ▲ EJECT button (5) | 19 CURSOR ↓ button (46) |
| 9 ▷ PLAY button (4, 18) | 20 SMARTFILE button (41, 45) |
| 10 JOG button/indicator (19) | 21 Remote sensor |
| 11 ● REC (record) button (7, 37) | 22 LINE-2 IN VIDEO/AUDIO L/R jacks (36) |

continued

Index to parts and controls (continued)

Display window

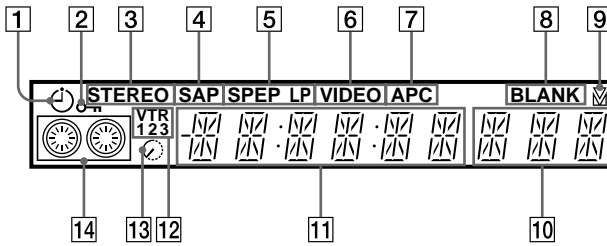

- | | |
|--|--|
| 1 Timer indicator (13) | 8 BLANK indicator (43) |
| 2 Child Lock indicator (14) | 9 Tracking indicator (33) |
| 3 STEREO indicator (30) | 10 Line/channel indicator (7, 37) |
| 4 SAP (Second Audio Program) indicator (30) | 11 Time counter/clock (5) |
| 5 Tape speed indicator (7) | 12 Command mode indicator |
| 6 VIDEO indicator (8) | 13 Remaining time indicator (8) |
| 7 APC (Adaptive Picture Control) indicator (33) | 14 Tape/recording indicator (7) |

Rear panel

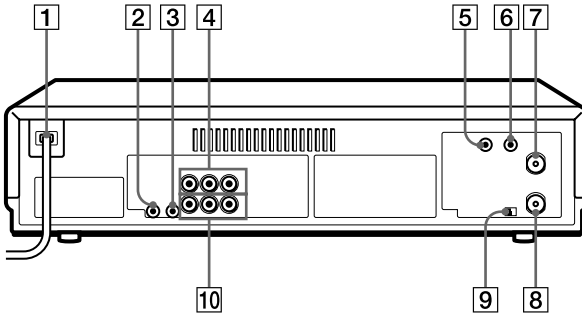

- | | |
|--|---|
| 1 AC power cord | 6 G-Link jack* |
| 2 S LINK (CONTROL S IN) jack (36) | 7 VHF/UHF IN connector (55) |
| 3 CABLE BOX CONTROL (CONTROL S OUT) jack | 8 VHF/UHF OUT connector (55) |
| 4 LINE-1 IN AUDIO L/R/VIDEO jacks (36, 55) | 9 RF (Radio Frequency) UNIT switch |
| 5 CPD (Control and Program Data) IN jack (55) | 10 LINE OUT AUDIO L/R/VIDEO jacks |

continued

* This jack is provided for future expected functions.

Index to parts and controls (continued)

Remote commander

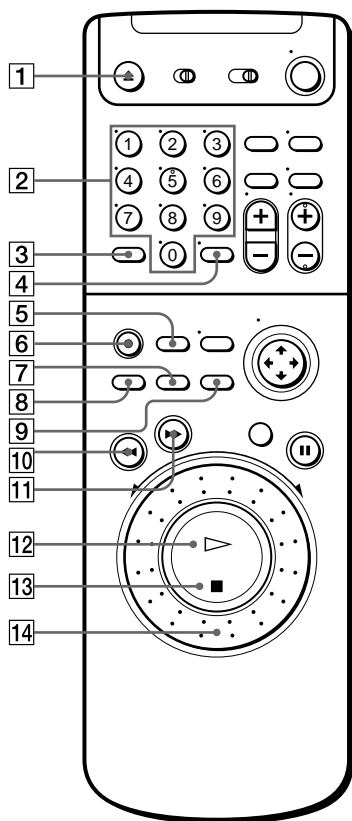

- 1 ▲ EJECT button (5)
- 2 Number buttons (13, 72)
- 3 SET button (24)
- 4 ENTER button (10, 25)
- 5 SMARTFILE button (41, 45)
- 6 ● REC (record) button (7)
- 7 Blue button (63, 64, 66, 71)
- 8 GUIDE button (57)
- 9 Green button (13, 63, 64, 71, 74)
- 10 ◀◀ REW (rewind) button (5, 18, 23)
- 11 ▶▶ FF (fast forward) button (5, 18, 23)
- 12 ▷ PLAY button (4)
- 13 ■ STOP button (5)
- 14 Shuttle ring (8, 19)

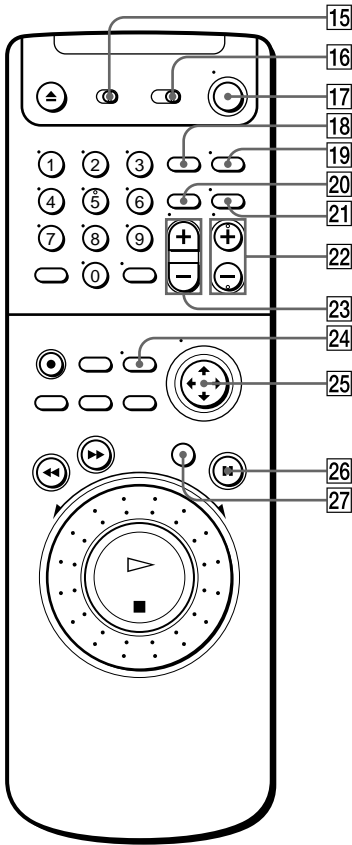

- 15 TV/VIDEO switch
- 16 COMMAND MODE switch
- 17 POWER switch (13, 16)
- 18 VCR Plus+ button (13, 64, 72)
- 19 TV/VIDEO button (8)
- 20 CLEAR button (27, 48)
- 21 DISPLAY button (5, 21, 54)
- 22 CH (channel) +/- buttons (7)
- 23 VOL (volume) +/- buttons
- 24 MENU button (15)
- 25 Cursor stick (13, 16, 43, 58)
 ↑/↓/←/→
 OK
- 26 || PAUSE button (5)
- 27 JOG button/indicator (19)

continued

Index to parts and controls (continued)

Remote commander, with top cover opened

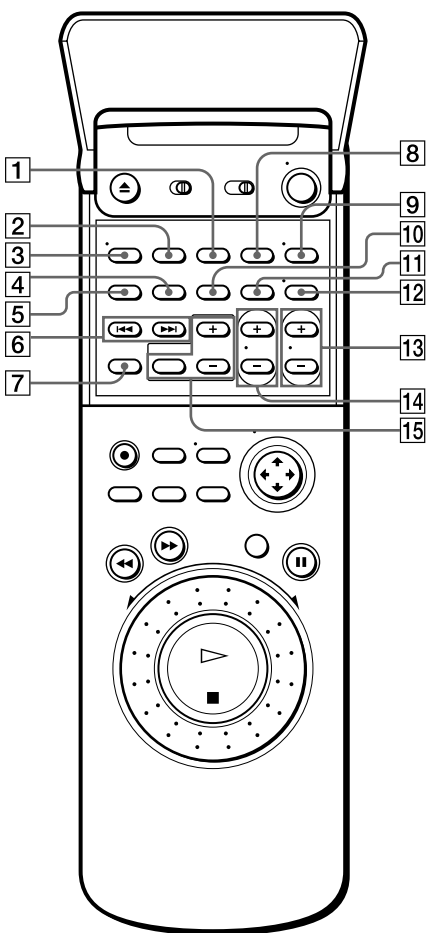

- 1 SP (Standard Play)/EP (Extra Play) button (7)
- 2 INFO (information) button (63)
- 3 AUDIO MONITOR button (30)
- 4 COUNTER RESET button (5)
- 5 QUICK TIMER button (26)
- 6 ◀▶ INDEX SEARCH buttons (32)
- 7 SMART CUE button (5)
- 8 INPUT SELECT button (7, 37)
- 9 TV/VIDEO button (8)
- 10 COUNTER/REMAIN button (8)
- 11 CLEAR button (27, 48)
- 12 DISPLAY button (5, 21, 54)
- 13 CH (channel) +/- buttons (7)
- 14 VOL (volume) +/- buttons
- 15 Receiver operation buttons
RECEIVER VOL (volume) +/- buttons
MUTING button

Index

A, B

- Accessories supplied 80
- Adjusting
 - picture 33
 - tracking 33
- APC (Adaptive Picture Control) 33
- Audio track 31
- Auto Tape Speed 35

C

- Canceling timer settings
 - GUIDE Plus+ timer 71
 - manual timer 27
- Changing timer settings
 - GUIDE Plus+ timer 71
 - manual timer 27
- Checking timer settings
 - GUIDE Plus+ timer 70
 - manual timer 27
- Child Lock 14
- Cleaning the video heads 77
- Counter 5

D

- DSS (Digital Satellite System) 55
- Dubbing. *See* Editing.

E, F

- Editing 36
- EP mode 7

G

- GUIDE Plus+ 57
 - canceling the GUIDE Plus+ timer settings 71
 - changing the GUIDE Plus+ timer settings 71
 - checking the GUIDE Plus+ timer settings 70
 - demonstration 76
 - getting information 62
 - locking the channel behind the menu 66
 - timer for recording 64, 68
 - timer for viewing 64, 69
 - viewing
 - advertisements 65

H

- Hi-fi audio track 31

I, J, K

- Index searching 32

L

- Locking the VCR 14
- LP mode 9, 20

M

- Monitoring audio during playback 30

N, O

- Normal audio track 31

P

- Picture adjustment. *See* Adjusting.
- Playback 4
 - at various speeds 18
 - frame-by-frame 19
 - skip 5
 - slow motion 19

Q

- Quick timer 26

R

- Recording 6
 - bilingual programs 30
 - SAP broadcasts 30
 - saving 8
 - stereo broadcasts 30
 - using GUIDE Plus+ 64, 68
 - using VCR Plus+ 12, 72
 - while watching another program 8

S

- Safety tab 8
- SAP (Second Audio Program) 30
- Searching
 - at various speeds 18
 - for a selected point 21
 - skip-search 23
- S-Link™ 36
- SmartFile 38
 - checking the contents of a tape 46
 - erasing the data of an unwanted program 54
 - labelling a recorded program and tape 47
 - protecting a recorded program 52
 - recording 41
 - selecting 45
 - SmartFile label 40
 - storing program data from the DSS receiver 55
- SP mode 7

T, U

- Timer recording
 - canceling timer settings 27, 71
 - changing timer settings 27, 71
 - checking timer settings 27, 70
 - daily/weekly recording 17
 - manual timer 15
 - overlapping timer recordings 28, 72
 - using GUIDE Plus+ 64, 68
 - using VCR Plus+ 12, 72
- Tracking adjustment. *See* Adjusting.

V, W, X, Y, Z

- VCR Plus+ recording 12, 72

Quick reference to using the VCR

Hookup 1

To play a tape

- 1 Set the TV to channel 3 or 4 (or to video input, if you made A/V connections.)
- 2 Insert a tape and press \triangleright PLAY.

To record a program

- 1 Turn on the cable box.
- 2 Press VCR Plus+ on the remote commander.
- 3 Enter the program's PlusCode number.
- 4 Press the cursor stick (OK).
- 5 Insert a tape.
- 6 Press POWER to turn off the VCR.
- 7 Leave the cable box on.

To watch TV

- 1 Turn off your VCR, or press the VCR's TV/VIDEO button until the VIDEO indicator in the display window goes off.
- 2 Turn on your cable box.
- 3 Set the TV to the cable box output channel (usually 2, 3, or 4).
- 4 Set the cable box to the channel you want to watch.

Hookup 2

To play a tape

- 1 If you made A/V connections, set the TV to video input.
If you didn't use A/V hookup:
 - Turn on the cable box.
 - Set the cable box to channel 3 or 4.
 - Set the TV to the output channel of the cable box (usually 2, 3, or 4).
- 2 Insert a tape and press \triangleright PLAY.

To record a program

- 1 Press VCR Plus+ on the remote commander.
- 2 Enter the program's PlusCode number.
- 3 Press the cursor stick (OK).
- 4 Insert a tape.
- 5 Press POWER to turn off the VCR.

To watch TV

- 1 Turn off your VCR, or press the VCR's TV/VIDEO button until the VIDEO indicator in the display window goes off.
- 2 Select the channel with your cable box (if you have one) or with your TV.

Hookup 3

To play a tape

- 1 Set the TV to channel 3 or 4 (or to video input, if you made A/V connections.)
- 2 Insert a tape and press \triangleright PLAY. If there's no picture on your TV, press the VCR's TV/VIDEO button until the VIDEO indicator comes on in the display window.

To record a program

- 1 Press VCR Plus+ on the remote commander.
- 2 Enter the program's PlusCode number.
- 3 Press the cursor stick (OK).
- 4 Insert a tape.
- 5 Press POWER to turn off the VCR.

To watch TV

- 1 Turn off your VCR, or press the VCR's TV/VIDEO button until the VIDEO indicator in the display window goes off.
- 2 Set the TV to the channel you want to watch.

Hookup 4

To play a tape

- 1 Set the TV to channel 3 or 4 (or to video input, if you made A/V connections.)
- 2 Insert a tape and press \triangleright PLAY.

To record a program

- 1 Turn on the cable box.
- 2 Set the cable box to the channel you want to record.
- 3 Press VCR Plus+ on the remote commander.
- 4 Enter the program's PlusCode number.
- 5 Press the cursor stick (OK).
- 6 Insert a tape.
- 7 Press POWER to turn off the VCR.
- 8 Leave the cable box on.

To watch TV

- 1 Turn off your VCR, or press the VCR's TV/VIDEO button until the VIDEO indicator in the display window goes off.
- 2 Turn on your cable box.
- 3 Set the TV to the cable box output channel (usually 2, 3, or 4).
- 4 Set the cable box to the channel you want to watch.

To order additional SmartFile Labels

Please call 1-888-293-9885.
Cost is \$9.95 for a package of 5 labels.

If you have any questions about this product, you may call: **Sony Customer Information Center 1-800-222-SONY (7669)** or write to: **Sony Customer Information Center Sony Drive, Mail Drop #T1-11, Park Ridge, NJ 07656**