

# Video Cassette Recorder

---

## Operating Instructions

### Owner's record

The model number is located at the rear of the unit and the serial number on the top. Record these numbers in the spaces provided below. Refer to them whenever you call upon your Sony dealer regarding this product.

Model No. \_\_\_\_\_

Serial No. \_\_\_\_\_



Hi-Fi

VCR *plus+*

SLV-760HF  
SLV-760HF MJ  
SLV-760HF PX  
SLV-761HF

## WARNING

To prevent fire or shock hazard, do not expose the unit to rain or moisture.

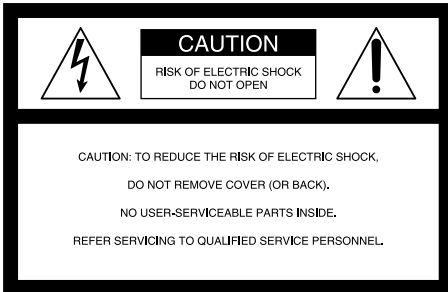

This symbol is intended to alert the user to the presence of uninsulated “dangerous voltage” within the product’s enclosure that may be of sufficient magnitude to constitute a risk of electric shock to persons.



This symbol is intended to alert the user to the presence of important operating and maintenance (servicing) instructions in the literature accompanying the appliance.

### CAUTION (SLV-760HF/761HF)

To prevent electric shock, do not use this polarized AC plug with an extension cord, receptacle or other outlet unless the blades can be fully inserted to prevent blade exposure.

## Precautions

### Safety

- For SLV-760HF/761HF, operate the unit only on 120 V AC, 60 Hz.  
For SLV-760HF MJ/760HF PX, operate the unit on 110 to 240 V AC, 50/60 Hz.
- If anything falls into the cabinet, unplug the unit and have it checked by qualified personnel before operating it any further.
- (SLV-760HF/761HF) One blade of the plug is wider than the other for the purpose of safety and will fit into the power outlet only one way. If you are unable to insert the plug fully into the outlet, contact your Sony dealer.
- (SLV-760HF/761HF) Unplug the unit from the wall outlet if you do not intend to use it for an extended period of time. To disconnect the cord, pull it out by the plug, never by the cord.

### Installing

- Allow adequate air circulation to prevent internal heat buildup.

- Do not place the unit on surfaces (rugs, blankets, etc.) or near materials (curtains, draperies) that may block the ventilation slots.
- Do not install the unit near heat sources such as radiators or air ducts, or in a place subject to direct sunlight, excessive dust, mechanical vibration or shock.
- Do not install the unit in an inclined position. It is designed to be operated in a horizontal position only.
- Keep the unit and cassettes away from equipment with strong magnets, such as microwave ovens or large loudspeakers.
- Do not place heavy objects on the unit.
- If the unit is brought directly from a cold to a warm location, moisture may condense inside the VCR and cause damage to the video head and tape. When you first install the unit, or when you move it from a cold to a warm location, wait for about one hour before operating the unit.

## Information

### For customers in the USA (SLV-760HF/760HF MJ/760HF PX/761HF)

This equipment has been tested and found to comply with the limits for a Class B digital device, pursuant to Part 15 of the FCC Rules. These limits are designed to provide reasonable protection against harmful interference in a residential installation. This equipment generates, uses, and can radiate radio frequency energy and, if not installed and used in accordance with the instructions, may cause harmful interference to radio communications. However, there is no guarantee that interference will not occur in a particular installation. If this equipment does cause harmful interference to radio or television reception, which can be determined by turning the equipment off and on, the user is encouraged to try to correct the interference by one or more of the following measures:

- Reorient or relocate the receiving antenna.
- Increase the separation between the equipment and receiver.
- Connect the equipment into an outlet on a circuit different from that to which the receiver is connected.
- Consult the dealer or an experienced radio/TV technician for help.

You are cautioned that any changes or modifications not expressly approved in this manual could void your authority to operate this equipment.

### Caution

Television programs, films, video tapes and other materials may be copyrighted. Unauthorized recording of such material may be contrary to the provisions of the copyright laws. Also, use of this recorder with cable television transmission may require authorization from the cable television transmission and/or program owner.

# Table of contents

## Getting Started

- 4 Step 1: Unpacking
- 5 Step 2: Setting up the remote commander
- 7 Step 3: Hookups
- 23 Step 4: Setting the clock
- 29 Presetting channels
- 33 Setting up VCR Plus+

## Basic Operations

- 36 Playing a tape
- 38 Recording TV programs
- 41 Recording TV programs using VCR Plus+
- 44 Setting the timer manually

## Additional Operations

- 46 Playing/searching at various speeds
- 48 Recording TV programs using the quick timer
- 49 Checking/changing/cancelling timer settings
- 50 Recording stereo and bilingual programs
- 52 Adjusting the picture
- 53 Changing menu options
- 54 Hooking up to a VCR or stereo system

## Additional Information

- 56 General setup information
- 58 Troubleshooting
- 60 Specifications
- 61 Index to parts and controls
- 65 Index
- back cover  
Quick reference to using the VCR

\* VCR Plus+ and PlusCode are trademarks of Gemstar Development Corporation. VCR Plus+ system is manufactured under license from Gemstar Development Corporation.

# Step 1

## Unpacking

Check that you have received the following items with the VCR:

- Remote commander

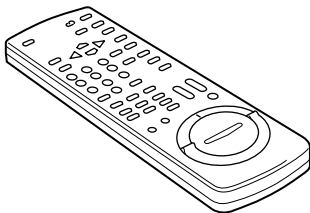

- AC power cord

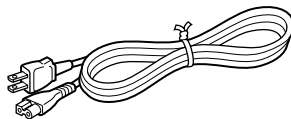

(SLV-760HF/761HF)

- Size AA (R6) batteries

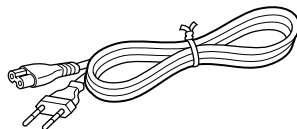
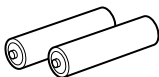

(SLV-760HF MJ/760HF PX)

- Audio/video cable (3-phono to 3-phono)

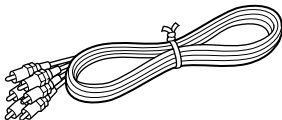

- Plug adaptor (SLV-760HF MJ/760HF PX)

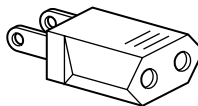

- 75-ohm coaxial cable with F-type connectors

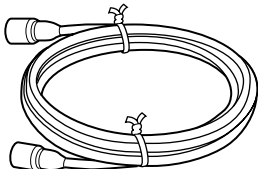

If the plug supplied with your VCR does not fit your power outlet, attach the supplied adaptor to the plug.

## Step 2

# Setting up the remote commander

### Inserting the batteries

Insert two size AA (R6) batteries by matching the + and - on the batteries to the diagram inside the battery compartment.

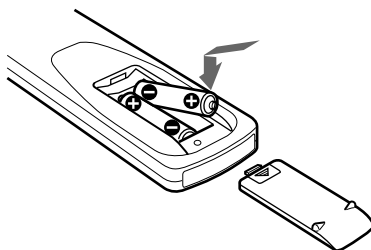

### Using the remote commander

You can use this remote commander to operate this VCR and a Sony TV. Buttons marked with a dot (•) can be used to operate your Sony TV.

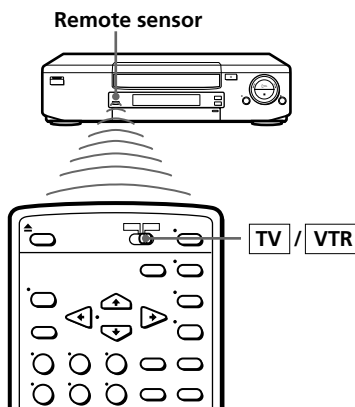

To operate	Set <b>TV</b> / <b>VTR</b> to
the VCR	<b>VTR</b> and point at the remote sensor on the VCR
a Sony TV	<b>TV</b> and point at the remote sensor on the TV

### Notes

- With normal use, the batteries should last about three to six months.
- If you do not use the remote commander for an extended period of time, remove the batteries to avoid possible damage from battery leakage.
- Do not use a new battery with an old one.
- Do not use different types of batteries.

**continued**

## Step 2: Setting up the remote commander (continued)

### Controlling other TVs with the remote commander

The remote commander is preprogrammed to control non-Sony TVs. If your TV is listed in the table below, set the appropriate manufacturer's code number.

- 1 Set **[TV]/[VTR]** at the top of the remote commander to **[TV]**.
- 2 Hold down **POWER**, and enter your TV's code number(s) using the number buttons. Then release **POWER**.

Now you can use the **POWER**, **VOL +/-**, **CH +/-** and **TV/VTR** buttons to control your TV. You can also use the buttons marked with a dot (•) to control a Sony TV. To control the VCR, reset **[TV]/[VTR]** to **[VTR]**.

### Code numbers of controllable TVs

If more than one code number is listed, try entering them one at a time until you find the one that works with your TV.

Manufacturer	Code number	Manufacturer	Code number	Manufacturer	Code number
Sony	01	KMC	03	RCA	04,10
Akai	04	Magnavox	03,08,12	Sampo	12
AOC	04	Marantz	04,13	Sanyo	11
Centurion	12	MGA/Mitsubishi	04,12,13,17	Scott	12
Coronado	03	NEC	04,12	Sears	07,10,11
Curis-Mathes	12	Panasonic	06,19	Sharp	03,05,18
Daytron	12	Philco	03, 04	Sylvania	08,12
Fisher	11	Philips	08	Teknika	03,08,14
General Electric	06,10	Pioneer	16	Toshiba	07
Hitachi	02,03	Portland	03	Wards	03,04,12
J.C.Penny	04,12	Quasar	06,18	Yorx	12
JVC	09	Radio Shack	05,14	Zenith	15

### Notes

- If the TV uses a different remote control system from the one programmed to work with the VCR, you cannot control your TV with the remote commander.
- If you enter a new code number, the code number previously entered will be erased.
- When you replace the batteries of the remote commander, the code number automatically resets to 01 (Sony). Reset the appropriate code number.

## Step 3

# Hookups

### Selecting the best hookup option

There are many ways in which your VCR can be hooked up. To hook up your VCR so that it works best for you, first scan through the table below. Then use the accompanying diagrams and procedures on the following pages to set up your VCR.

If you have	Use	Refer to
TV that has audio/video inputs	<b>Audio/video (A/V) hookup</b> , then follow one of the hookups below.	<b>Pages 8 to 9</b>
Antenna only, no cable TV	<b>Hookup 1</b>	<b>Pages 10 to 12</b>
Cable box with many scrambled channels	<b>Hookup 2</b>	<b>Pages 13 to 15</b>
No cable box or cable box with only a few scrambled channels	<b>Hookup 3</b>	<b>Pages 16 to 18</b>
Cable box with only a few scrambled channels, using an A/B switch	<b>Hookup 4</b>	<b>Pages 19 to 22</b>

After you've completed the connections, follow the instructions for setup. During setup, if you need more details on the procedure described, page numbers are provided where you can find complete, step-by-step instructions.

After you've completed the setup, you're ready to use your VCR. Procedures differ depending on the hookup you used. For an overview, refer to "Quick reference to using the VCR" on the back cover.

#### Before you get started

- Turn off the power to all equipment.
- Do not connect the AC power cords until all of the connections are completed.
- Be sure you make connections firmly. Loose connections may cause picture distortion.
- If your TV doesn't match any of the examples provided, see your nearest Sony dealer or qualified technician.

## Step 3: Hookups (continued)

### Audio/video (A/V) hookup

Pages 8 to 9

If your TV has audio/video (A/V) input jacks, you will get a better picture and sound if you hook up your VCR using these connections. In addition, for a true “home theater” experience, you should connect the audio outputs of your VCR or TV to your stereo system. If your TV doesn’t have A/V inputs, see the following pages for antenna or cable hookups.

If you’re not planning to use your VCR to record programs, you’re finished setting up the VCR after you’ve made the connections shown on pages 8 and 9.

If you want to record off-air or off your cable TV system, complete these connections first, and then go to the following pages for antenna or cable hookups.

#### **A** Use this hookup if your TV has stereo jacks

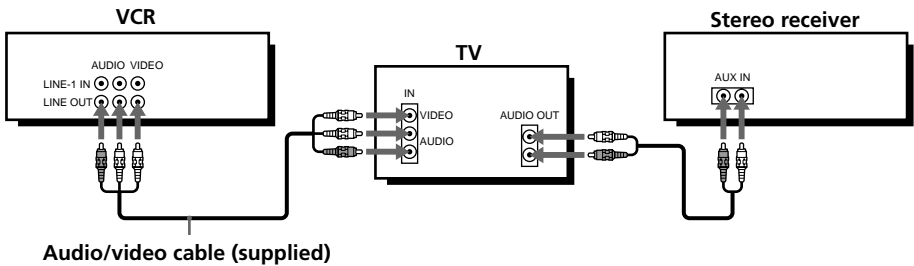

#### **B** Use this hookup if your TV doesn't have stereo jacks

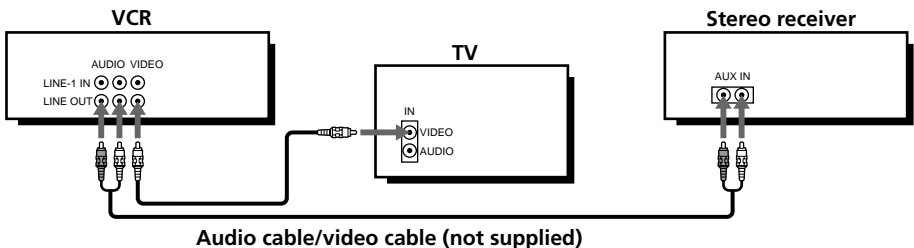

#### **Note**

To play a tape in stereo, you must use the A/V connection.



## A/V hookup: VCR setup

After you've connected your TV and completed antenna or cable hookup, use the following procedure to set up the VCR.

**Press MENU and select  
ADVANCED OPTIONS.**

MENU	
TIMER SET / CHECK	
TUNER PRESET	
CLOCK SET	
SET VCR Plus+ CHANNELS	
▶ADVANCED OPTIONS	
SELECT : [↕]	
SET : [EXECUTE]	



**Set AUTO ANT SEL to  
OFF and press EXECUTE.**

ADVANCED OPTIONS		
▶AUTO ANT SEL	ON	•OFF
AUTO STEREO	•ON	OFF
DIMMER	ON	•OFF
AUDIO MIX	ON	•OFF
NORMAL AUDIO	•MAIN	SAP
APC	•ON	OFF
SELECT : [↕]		
SET : [↔]		

For details, see  
page 53.

### Caution

Connections between the VCR's VHF/UHF connector and the antenna terminals of the TV receiver should be made only as shown in the following instructions. Failure to do so may result in operation that violates the regulations of the Federal Communications Commission regarding the use and operation of RF devices. Never connect the output of the VCR to an antenna or make simultaneous (parallel) antenna and VCR connections at the antenna terminals of your receiver.

### Note to CATV system installer

This reminder is provided to call the CATV system installer's attention to Article 820-40 of the NEC that provides guidelines for proper grounding and, in particular, specifies that the cable ground shall be connected to the grounding system of the building, as close to the point of cable entry as practical.

### Antenna hookup

Make the following connections if you're using an antenna (if you don't have cable TV).

**A Use this hookup if you're using:**

- VHF/UHF antenna (you get channels 2–13 and channels 14 and higher)
- UHF-only antenna (you get channels 14 and higher)
- Separate VHF and UHF antennas

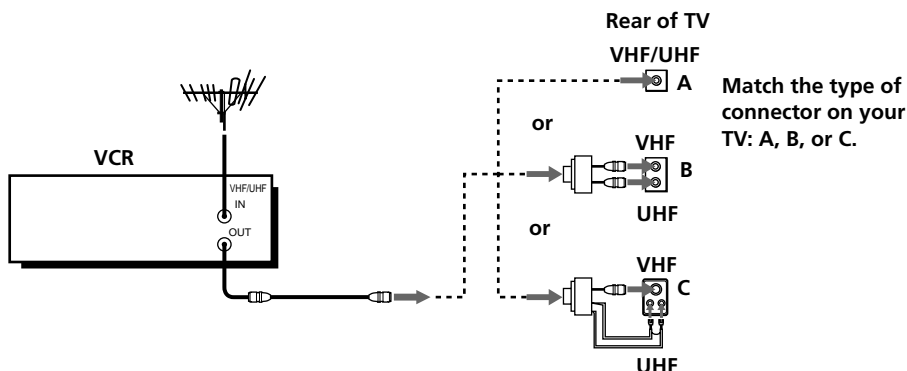

**B Use this hookup if you're using a VHF-only antenna (you get channels 2–13 only)**

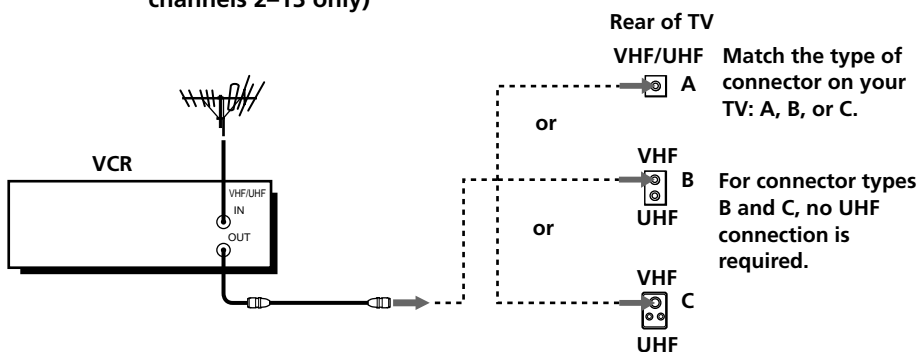

**If you cannot connect your antenna cable to the VCR directly**

If your antenna cable is a flat cable (300-ohm twin lead cable), attach an external antenna connector (not supplied) so that you can connect the cable to the VHF/UHF IN connector. If you have separate cables for VHF and UHF antennas, you should use a U/V band mixer (not supplied). For details, see page 57.

## Hookup 1: VCR setup

- 1 Set the RF UNIT switch to CH 3 or CH 4, whichever channel is not used in your area. If both are used, set the switch to either channel.

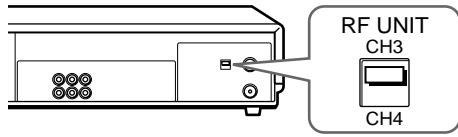

For details, see page 56. If you made A/V connections (pages 8 and 9), you can skip this step.

- 2 Set the clock. For details, see page 23.

- 1 Press MENU and select CLOCK SET.

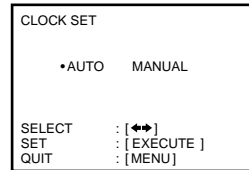

- 2 Select AUTO, then press EXECUTE.

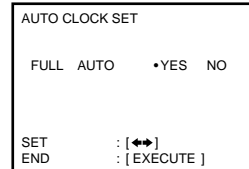

- 3 Set FULL AUTO to YES, then press EXECUTE.

- 3 Preset the channels into the VCR. For details, see page 29.

- 1 Press MENU and select TUNER PRESET.

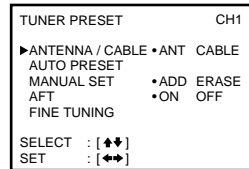

- 2 Set ANTENNA/CABLE to ANT.

- 3 Select AUTO PRESET and press EXECUTE.

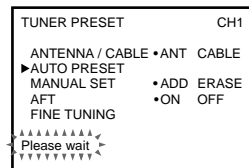

**continued**

## Step 3: Hookups (continued)

### Hookup 1: VCR Plus+ channel setup

- 1 Find the VCR Plus+ Channel Listing in your program guide. For details, see page 33.
- 2 If the channels in the program guide are different from the channels that you actually use on your TV, set the channels that are different as follows. For details, see page 34.
  - 1 Press MENU and select SET VCR Plus+ CHANNELS.
- 2 Enter the program guide channel, then the channel you use on your TV.
- 3 Press EXECUTE.

```
MENU
TIMER SET / CHECK
TUNER PRESET
CLOCK SET
▶SET VCR Plus+ CHANNELS
  ADVANCED OPTIONS
SELECT : [◆◆]
SET    : [EXECUTE]
```

```
SET VCR Plus+ CHANNELS
GUIDE CH  TV CH
  25    -   15
Push [0-9] keys to set
program GUIDE CH
Or, push [ EXECUTE ] to see
VCR Plus+ CHANNEL LIST
```

Program guide channel

Your actual TV channel

#### Automatic clock setting

If you select AUTO in the CLOCK SET menu, then set FULL AUTO to YES, it automatically sets the clock the first time you turn off the VCR. After that, whenever you turn off the VCR, it checks the time and adjusts the clock, even for Daylight Saving Time. The VCR sets the clock by picking up a time signal provided by some TV channels.

If you want to use the timer to record right away, or if the channels in your area do not carry time signals, set the clock manually. For details, see pages 27 and 28.

## Cable box with many scrambled channels

### Recommended use

Use this hookup if your cable system scrambles all or most channels.

### What you can do with this hookup

- Record any channel by selecting the channel on the cable box

### What you can't do

- Record with the cable box off
- Record one channel while watching another channel

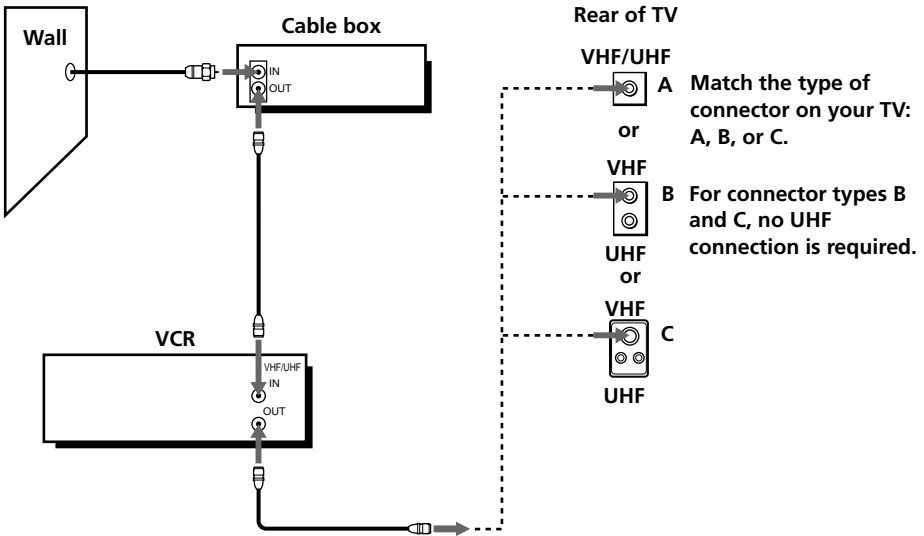

continued



## Hookup 2: VCR Plus+ channel setup

- 1 Find the VCR Plus+ Channel Listing in your program guide. For details, see page 33.
- 2 Enter all the channels you want to record and the cable box output channel (usually 2, 3, or 4). For details, see page 34.
  - 1 Press MENU and select SET VCR Plus+ CHANNELS.
- 2 Enter the program guide channel, then the cable box output channel.
- 3 Press EXECUTE.

```

MENU
TIMER SET / CHECK
TUNER PRESET
CLOCK SET
▶SET VCR Plus+ CHANNELS
ADVANCED OPTIONS

SELECT : [▲◆]
SET    : [EXECUTE]
  
```

```

SET VCR Plus+ CHANNELS

GUIDE CH  TV CH
33  -   5

Push [0-9] keys to set
program GUIDE CH

Or, push [ EXECUTE ] to see
VCR Plus+ CHANNEL LIST
  
```

Program guide channel

Cable box output channel

### Automatic clock setting

To use the Auto Clock Set feature with this hookup, you need to manually select a channel that carries a time signal:

- 1 Tune the cable box to a channel that carries a time signal.
- 2 Select AUTO in the CLOCK SET menu to turn on the Auto Clock Set feature.
- 3 Turn off the VCR. It automatically sets the clock and adjusts for Daylight Saving Time by picking up the time signal.

If you want to use the timer to record right away, or if the channels in your area do not carry time signals, set the clock manually. For details, see pages 27 and 28.

### Note

To use the automatic clock setting feature, leave the cable box on.

### No cable box, or cable box with only a few scrambled channels

#### Recommended use

Use this hookup if you do not have a cable box. Also use this hookup if your cable system scrambles only a few channels.

#### What you can do with this hookup

- Record any unscrambled channel by selecting the channel on the VCR

#### What you can't do

- Record scrambled channels that require a cable box

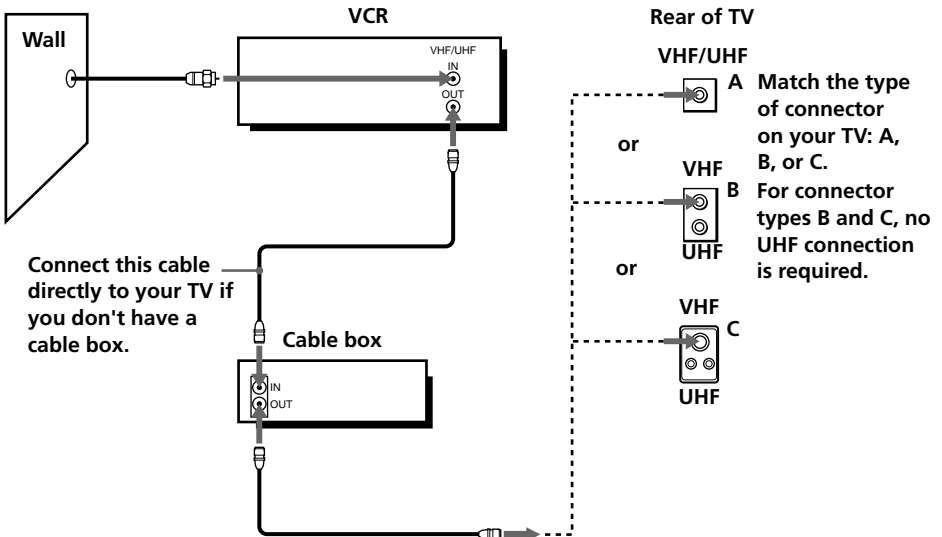



## Hookup 3: VCR setup

- 1 Set the RF UNIT switch to CH 3 or CH 4, whichever channel is not used in your area. If both are used, set the switch to either channel.

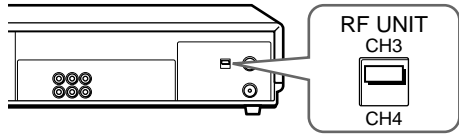

For details, see page 56. If you made A/V connections (pages 8 and 9), you can skip this step.

- 2 Turn on your cable box.
- 3 Set the clock. For details, see page 23.

- 1 Press MENU and select CLOCK SET.

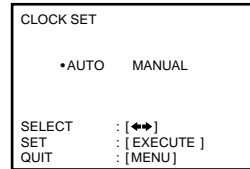

- 2 Select AUTO, then press EXECUTE.

- 3 Set FULL AUTO to YES, then press EXECUTE.

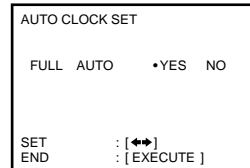

- 4 Preset the channels into the VCR. For details, see page 29.

- 1 Press MENU and select TUNER PRESET.

- 2 Set ANTENNA/CABLE to CABLE.

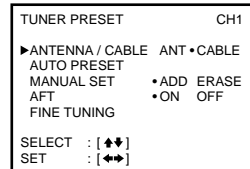

- 3 Select AUTO PRESET and press EXECUTE.

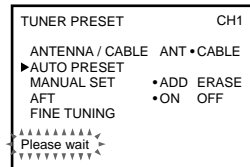

**continued**

## Step 3: Hookups (continued)

### Hookup 3: VCR Plus+ channel setup

- 1 Find the VCR Plus+ Channel Listing in your program guide. For details, see page 33.
- 2 If the channels in the program guide are different from the channels that you actually use on your TV, set the channels that are different as follows. For details, see page 34.

- 1 Press MENU and select SET VCR Plus+ CHANNELS.

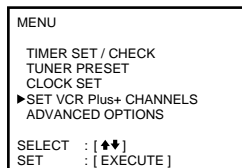

- 2 Enter the program guide channel, then the channel you use on your TV.

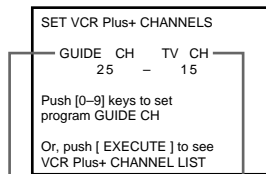

- 3 Press EXECUTE.

Program guide channel

Your actual TV channel

#### Automatic clock setting

If you select AUTO in the CLOCK SET menu, then set FULL AUTO to YES, it automatically sets the clock the first time you turn off the VCR. After that, whenever you turn off the VCR, it checks the time and adjusts the clock, even for Daylight Saving Time. The VCR sets the clock by picking up a time signal provided by some TV channels.

If you want to use the timer to record right away, or if the channels in your area do not carry time signals, set the clock manually. For details, see pages 27 and 28.

## Cable box with only a few scrambled channels, using an A/B switch

### Recommended use

By using an A/B switch (not supplied), this hookup allows you to record both scrambled and unscrambled channels conveniently.

### What you can do with this hookup

- Record any unscrambled channel by selecting the channel directly on the VCR (the A/B switch is set to A)
- Record any scrambled channel by selecting the channel on the cable box (the A/B switch is set to B)

### What you can't do

- Record one scrambled channel while watching another channel (the A/B switch is set to B)

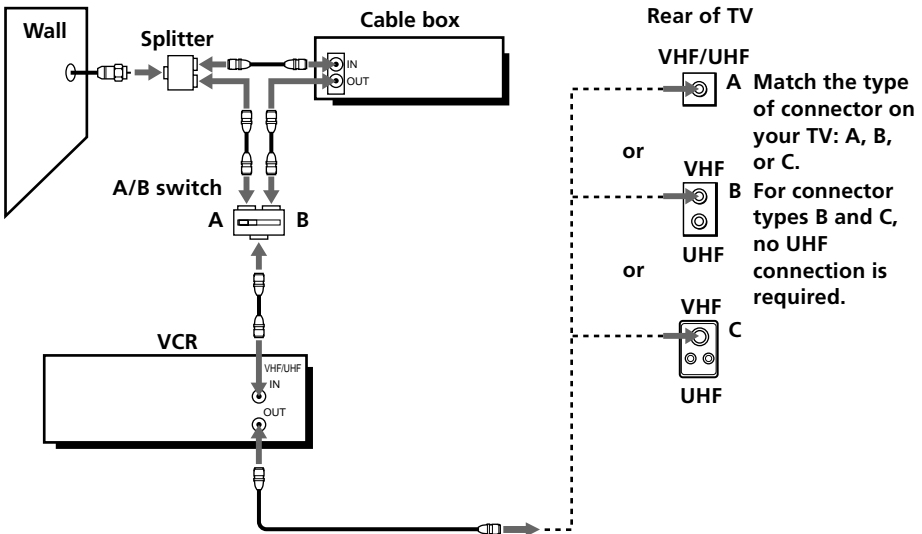

continued



**5** Preset the cable box output channel (usually 2, 3 or 4). For details, see page 31.

❶ Press MENU and select TUNER PRESET.

❷ Enter the cable box output channel.

❸ Set MANUAL SET to ADD and press EXECUTE.

**Cable box output channel**

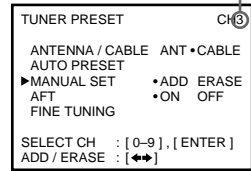

## Step 3: Hookups (continued)

### Hookup 4: VCR Plus+ channel setup

- 1 Find the VCR Plus+ Channel Listing in your program guide. For details, see page 33.
- 2 For unscrambled channels, if the channels in the program guide are different from the channels that you actually use on your TV, set the channels that are different as follows. For details, see page 34.

- 1 Press MENU and select SET VCR Plus+ CHANNELS.

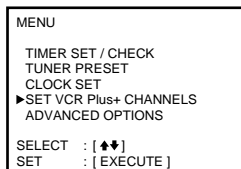

- 2 Enter the program guide channel, then the channel you use on your TV.

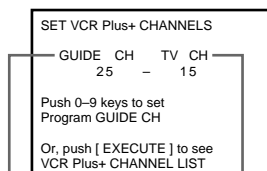

Program guide channel

Your actual TV channel

- 3 Press EXECUTE.

- 3 For scrambled channels, enter all the scrambled channels you want to record and the cable box output channel (usually 2, 3, or 4). For details, see page 34.

- 1 Press MENU and select SET VCR Plus+ CHANNELS.

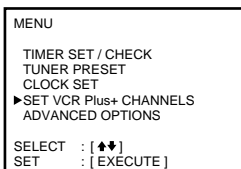

- 2 Enter the program guide channel, then the cable box output channel.

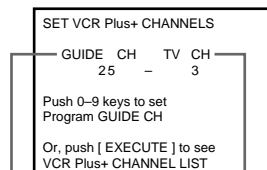

Program guide channel

Cable box output channel

## Step 4

# Setting the clock

## Using the Auto Clock Set feature

Some TV and cable channels transmit time signals with their broadcasts. Your VCR can pick up this time signal to automatically set the clock.

The Auto Clock Set feature works only if a channel in your area is broadcasting a time signal. If broadcasters in your area are not yet sending time signals, set the time manually (page 27).

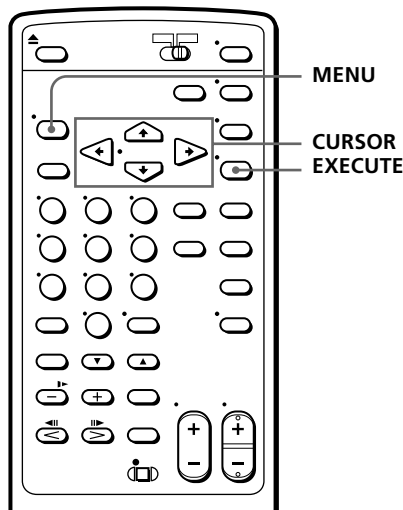

### Before you start...

- Turn on the VCR and the TV.
- Set the TV to the VCR channel (channel 3 or 4). If your TV is connected to the VCR using A/V connections, set the TV to video input.
- Press TV/VTR to display the VTR indicator in the VCR's display window.
- Press INPUT SELECT so that a channel number appears in the VCR's display window.

### 1

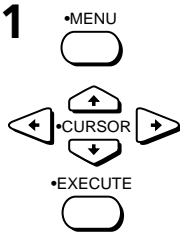

Press MENU, then press CURSOR  $\uparrow/\downarrow$  to move the cursor ( $\blacktriangleright$ ) to CLOCK SET and press EXECUTE.

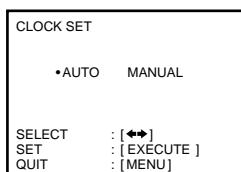

### 2

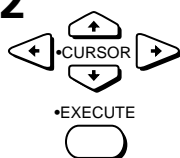

Press CURSOR  $\leftarrow/\rightarrow$  to select AUTO, then press EXECUTE.

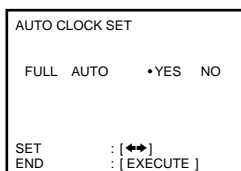

continued

---

## Setting the clock (continued)

---

3

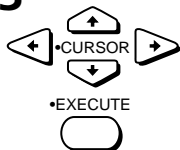

Press CURSOR ←/→ to set FULL AUTO to YES, then press EXECUTE.

4

To activate the Auto Clock Set function, turn off the VCR.

The VCR automatically sets the clock by searching for a channel that carries a time signal and sets your time zone and Daylight Saving Time (if applicable).

If your clock is set to the wrong time zone or Daylight Saving Time, you can adjust these settings without turning off the Auto Clock Set feature (page 25).

---

### Notes

- The clock cannot be set automatically if you don't receive a channel that carries a time signal in your area. If so, set the clock manually.
- If there are only a few channels in your area that carry time signals, setting the clock automatically may take up to about 30 minutes. If nothing happens even after you wait about 30 minutes, set the clock manually.
- If you use Hookup 2, make sure you leave the cable box on.



## If the clock is not activated

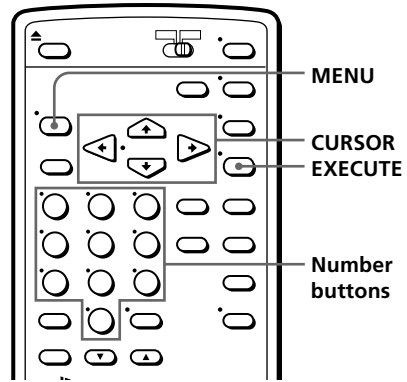

### 1

Follow steps 1 and 2 in "Using the Auto Clock Set feature."  
The AUTO CLOCK SET menu is displayed.

### 2

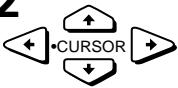

Press CURSOR  $\leftarrow/\rightarrow$  to set FULL AUTO to NO.

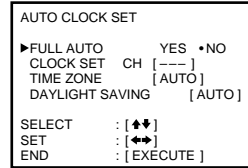

### 3

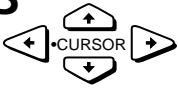

Press CURSOR  $\uparrow/\downarrow$  to move the cursor ( $\blacktriangleright$ ) to the item you want to set, then change the setting with the CURSOR  $\leftarrow/\rightarrow$ .

- For CLOCK SET CH

Leave CLOCK SET CH to "---" to have the VCR automatically search for a channel that carries a time signal. Press the number buttons to search a channel that carries a time signal. Use this option if you know of a channel that carries a time signal. Most PBS member stations broadcast a time signal. For the fastest response, select your local PBS station.

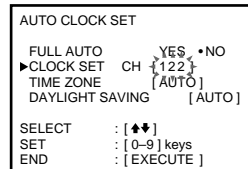

**continued**

## Setting the clock (continued)

- For TIME ZONE  
Select the time zone of your area, or select AUTO to have the VCR automatically set your time zone.
- The options are:  
AUTO → ATLANTIC → EASTERN → CENTRAL → MOUNTAIN → PACIFIC → ALASKA → HAWAII → AUTO.

```
AUTO CLOCK SET
FULL AUTO      YES, *NO
CLOCK SET CH  {122}
▶TIME ZONE     [ATLANTIC]
DAYLIGHT SAVING [AUTO]

SELECT        : [↕↕]
SET           : [↕↕]
END           : [EXECUTE]
```

- For DAYLIGHT SAVING  
Select ON or OFF (standard time), or AUTO to have the VCR automatically set the Daylight Saving Time.

```
AUTO CLOCK SET
FULL AUTO      YES, *NO
CLOCK SET CH  {122}
TIME ZONE     [ATLANTIC]
▶DAYLIGHT SAVING [ON]

SELECT        : [↕↕]
SET           : [↕↕]
END           : [EXECUTE]
```

---

**4** EXECUTE



Press EXECUTE.

---

**5**

To activate the Auto Clock Set function, turn off the VCR.

---

## Using Manual Clock Set

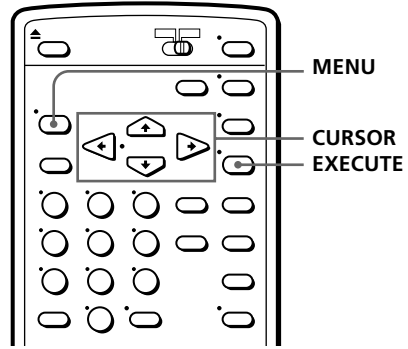

- 1** Press MENU, then press CURSOR  $\uparrow/\downarrow$  to move the cursor ( $\blacktriangleright$ ) to CLOCK SET and press EXECUTE.

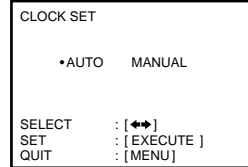
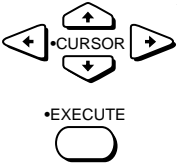

- 2** Press CURSOR  $\leftarrow/\rightarrow$  to select MANUAL and press EXECUTE.

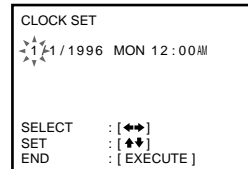
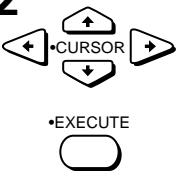

- 3** Press CURSOR  $\uparrow/\downarrow$  to set the month.

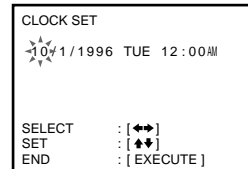

- 4** Press CURSOR  $\rightarrow$  to flash the day and press CURSOR  $\uparrow/\downarrow$  to set the day. The day of the week is set automatically.

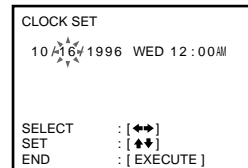
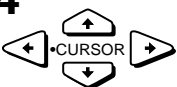

**continued**

---

## Setting the clock (continued)

---

5



Set the year, hour and minutes in the same way as the day.

---

6



Press EXECUTE to start the clock.

---

# Presetting channels

This VCR is capable of receiving VHF channels 2 to 13, UHF channels 14 to 69 and unscrambled CATV channels 1 to 125. First, we recommend that you preset the receivable channels in your area using automatic presetting. Then, if there are any unwanted channels, disable them manually. If you have decided which channels you wish to preset, set them directly using manual presetting.

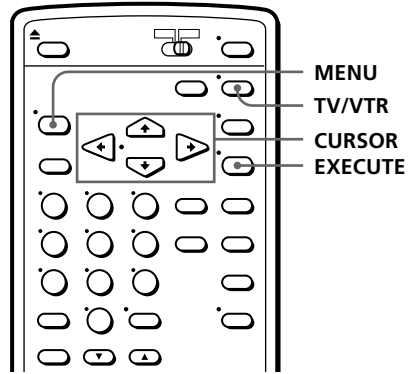

## Before you start...

- Turn on the VCR and the TV.
- Set the TV to the VCR channel (channel 3 or 4). If your TV is connected to the VCR using A/V connections, set the TV to video input.
- Press TV/VTR to display the VTR indicator in the VCR's display window.
- Press INPUT SELECT so that a channel number appears in the VCR's display window.

## Presetting all receivable channels automatically

- 1** Press MENU, then press CURSOR  $\uparrow/\downarrow$  to move the cursor ( $\blacktriangleright$ ) to TUNER PRESET and press EXECUTE.

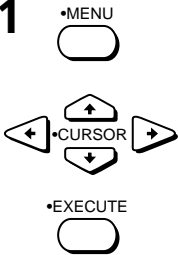

TUNER PRESET	CH1
ANTENNA / CABLE	ANT • CABLE
AUTO PRESET	
▶ MANUAL SET	• ADD ERASE
AFT	• ON OFF
FINE TUNING	
SELECT CH : [0-9], [ENTER]	
ADD / ERASE : [↔]	

- 2** Press CURSOR  $\uparrow/\downarrow$  to select ANTENNA/CABLE.

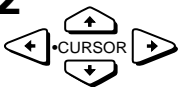

**continued**

## Presetting channels (continued)

3



- To preset cable TV channels:  
Press CURSOR  $\leftarrow/\rightarrow$  to set ANTENNA/CABLE to CABLE.

```
TUNER PRESET          CH1
▶ANTENNA / CABLE  ANT •CABLE
AUTO PRESET
MANUAL SET          •ADD ERASE
AFT                  •ON  OFF
FINE TUNING
SELECT : [▲▼]
SET      : [◀▶]
```

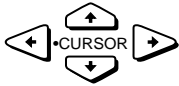

- To preset VHF and UHF channels:  
Press CURSOR  $\leftarrow/\rightarrow$  to set ANTENNA/CABLE to ANT.

```
TUNER PRESET          CH2
▶ANTENNA / CABLE  •ANT  CABLE
AUTO PRESET
MANUAL SET          •ADD ERASE
AFT                  •ON  OFF
FINE TUNING
SELECT : [▲▼]
SET      : [◀▶]
```

4



Press CURSOR  $\uparrow/\downarrow$  to select AUTO PRESET, then press EXECUTE.

All receivable channels are preset in numerical sequence. When no more receivable channels can be found, presetting stops and the picture from the lowest numbered channel is displayed on the TV screen.



```
TUNER PRESET          CH2
  ANTENNA / CABLE •ANT  CABLE
▶AUTO PRESET
MANUAL SET          •ADD ERASE
AFT                  •ON  OFF
FINE TUNING
Please wait
*****^
```

### Tip

- When receiving a VHF, UHF or CATV channel, the display changes as follows each time you press the DISPLAY button.

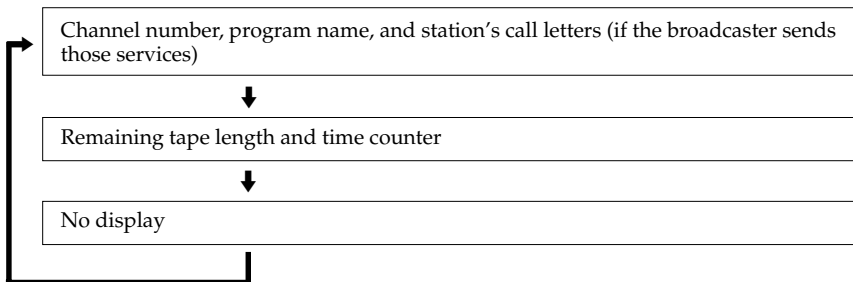

## Presetting/disabling channels manually

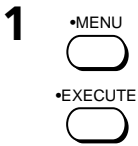
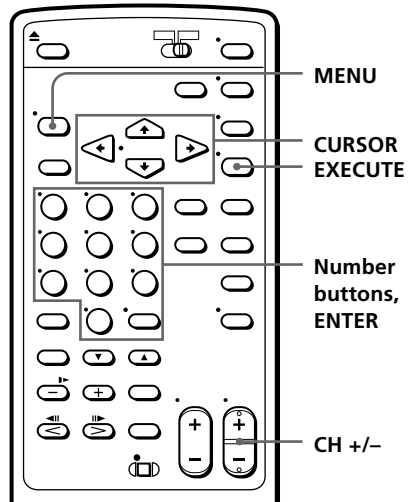

Press **MENU** and select **TUNER PRESET**, then press **EXECUTE**.

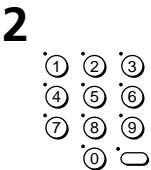
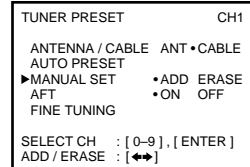

• To preset a channel:

- 1 Press the number buttons to enter the channel number, then press **ENTER**.
- 2 Press **CURSOR** ←/→ to set **MANUAL SET** to **ADD**.

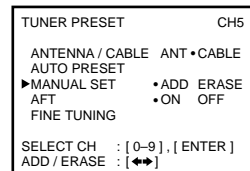

• To disable a channel:

- 1 Press **CH +/-** to select the channel number.
- 2 Press **CURSOR** ←/→ to set **MANUAL SET** to **ERASE**.

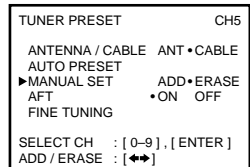

Repeat step 2 to preset or disable channels as required, then press **EXECUTE**.

## Presetting channels (continued)

### If the picture is not clear

Normally, the Auto Fine Tuning (AFT) function automatically tunes in channels clearly. If, however, the picture of a channel is not clear, you can also use the manual tuning function.

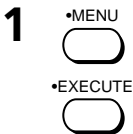
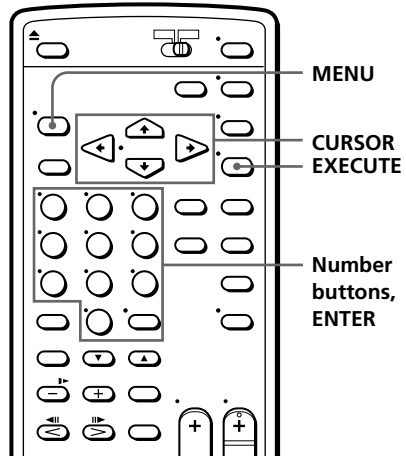

Press MENU and select TUNER PRESET, then press EXECUTE.

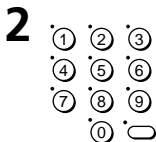
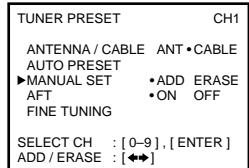

Press the number buttons to select the channel you want to fine-tune, then press ENTER.

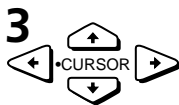
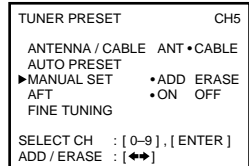

Press CURSOR ↑/↓ to select FINE TUNING.

The fine tuning meter appears.

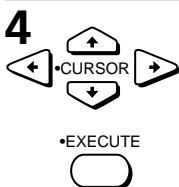
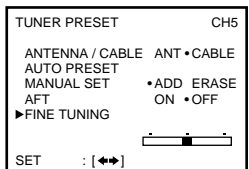

Press CURSOR ←/→ to adjust to a clearer picture, then press EXECUTE.

Note that the AFT setting switches to OFF.

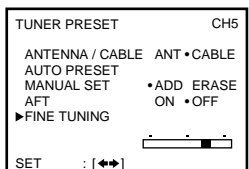



# Setting up VCR Plus+

## How VCR Plus+ works

Whenever you want to record a TV program, all you need to do is look up the program's "PlusCode," a number assigned to each program that's published in the TV section of most newspapers, cable TV listings, and even *TV GUIDE* magazine. Then, just enter the PlusCode of the program you want and the VCR is automatically programmed to record that show. It's that simple.

## How to set up your VCR

Setting up your VCR involves coordinating the TV channel number (the number you turn to on your TV or VCR to watch a program) with the guide channel (the number that's assigned to that channel in your program guide). To get the guide channel numbers, find the "Channel Line-up Chart" in the program guide for your area that features VCR PlusCodes. It usually looks like the example to the right.

For each channel your VCR receives, use the Channel Line-up Chart to check that the channel numbers match. For example, if HBO is listed in the Channel Line-up Chart on channel 33, and your VCR receives HBO on channel 5, you need to coordinate these numbers using the following procedure. For channels in which the numbers are the same, you can skip this procedure.

## Example of "PlusCode"

		PlusCode
5:30	<b>14</b> MOVIE — Musical (2hrs.)	<b>33044</b>
	<b>2</b> SPORT — Golf (1hr. 25min.)	42060
	<b>CNN</b> — WS 9974	
6:30	<b>2</b> <b>3</b> <b>4</b> DRAMA — Comedy (2hrs.)	17390
	<b>5</b> SCIENCE AND TECHNOLOGY (1hr. 15min.)	73457

## Example of "Channel Line-up Chart"

CABLE CH	CABLE TV	VCR Plus+ GUIDE CH
16	<b>AMC</b> American Movie Classics	35
17	<b>BRV</b> Bravo (program grid only)	54
20	<b>CNN</b> Cable News Network	42
21	<b>CSP</b> C-SPAN	28
22	<b>DIS</b> The Disney Channel	53
25	<b>DSC</b> The Discovery Channel	37
34	<b>ESN</b> ESPN	34
35	<b>FAM</b> The Family Channel	47
5	<b>HBO</b> Home Box Office	33
27	<b>LIF</b> Lifetime	46
29	<b>MAX</b> Cinemax	45
30	<b>MTV</b> Music Television	48
31	<b>NIK</b> Nickelodeon	38
38	<b>SC</b> Sports Channel	59
39	<b>SCA</b> Sports Channel America	70
45	<b>SHO</b> Showtime	41
17	<b>TBS</b> TBS SuperStation	43
44	<b>TMC</b> The Movie Channel	58
49	<b>TNN</b> The Nashville Network	49
50	<b>TNT</b> Turner Network Television	52
51	<b>USA</b> USA Network	44

continued

## Setting up VCR Plus+ (continued)

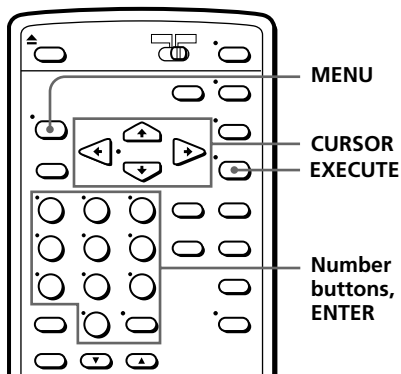

- 1** Press MENU, then press CURSOR  $\uparrow/\downarrow$  to move the cursor ( $\blacktriangleright$ ) to SET VCR Plus+ CHANNELS and press EXECUTE.

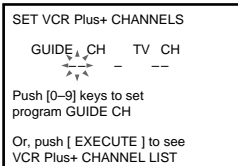
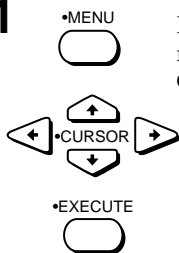

- 2** Enter the channel number assigned in the program guide and press ENTER.

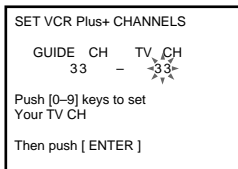
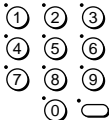

- 3**
- If you made Hookup 1 or 3: Enter the actual number on your TV (and VCR) and press ENTER.
  - If you made Hookup 2: Enter the cable output channel (usually 2, 3 or 4) and press ENTER.
  - If you made Hookup 4: Enter the actual number on your TV (and VCR) for an unscrambled channel and press ENTER. For a scrambled channel, enter the cable box output channel (usually 2, 3 or 4) and press ENTER.

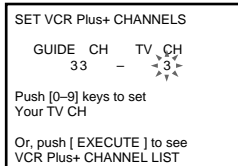
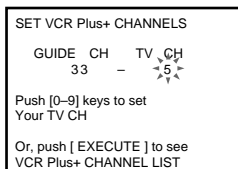

**4**

Repeat steps 2 and 3 for each channel whose numbers don't match.

**5**

•EXECUTE



When you have set all channels, press EXECUTE to confirm your channel settings.

VCR Plus+ CHANNEL LIST			
PAGE 1			
GUIDE	TV	GUIDE	TV
2	- 73	59	- 47
5	- 4	61	- 3
17	- 55	77	- 35
28	- 9	86	-120
33	- 5	90	- 22

Use ◀▶ to change page  
Push [ MENU ] to quit

**6**

•MENU



When you've finished, press MENU to exit.

# Playing a tape

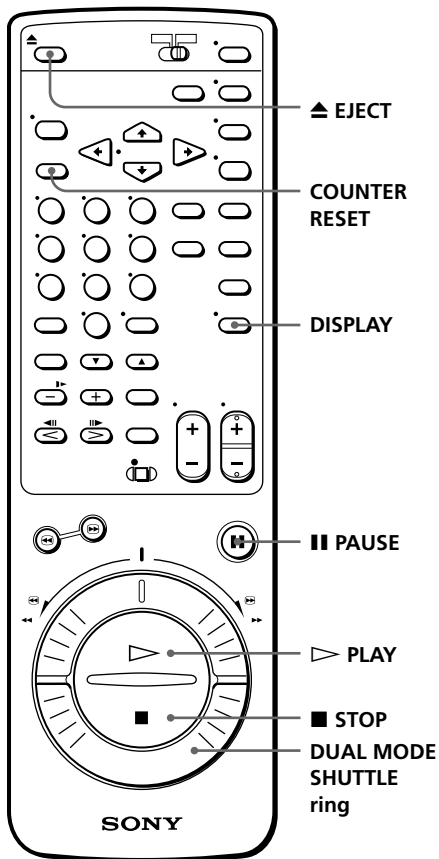

**1** Turn on your TV and set it to the video channel.

**2** Insert a tape.  
The VCR turns on and starts playing automatically if you insert a tape with its safety tab removed.

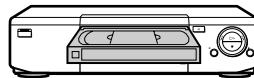

**3**  Press **▶ PLAY**.  
When the tape reaches the end, it will rewind automatically.

## Additional tasks

To	Press
Stop play	■ STOP
Pause play	▬ PAUSE
Resume play after pause	▬ PAUSE or ▷ PLAY
Search forward	Turn the DUAL MODE SHUTTLE (DMS) ring to ⏭ during playback
Search backward	Turn the DMS ring to ⏮ during playback
Fast-forward the tape	Turn the DMS ring to ⏩ FF during stop
Rewind the tape	Turn the DMS ring to ⏪ REW during stop
Eject the tape	▲ EJECT

## To use the time counter

At the point on the tape that you want to find later, press COUNTER RESET. The counter in the display window resets to "0H00M00S." Search for the point afterwards by referring to the counter.





To display the counter on the TV screen, press DISPLAY.

### Notes

- Tapes recorded in the LP mode on other VCRs can be played back on this VCR but the picture quality cannot be guaranteed.
- The counter resets to "0H00M00S" whenever a tape is reinserted.
- The counter stops counting when it comes to a portion with no recording.

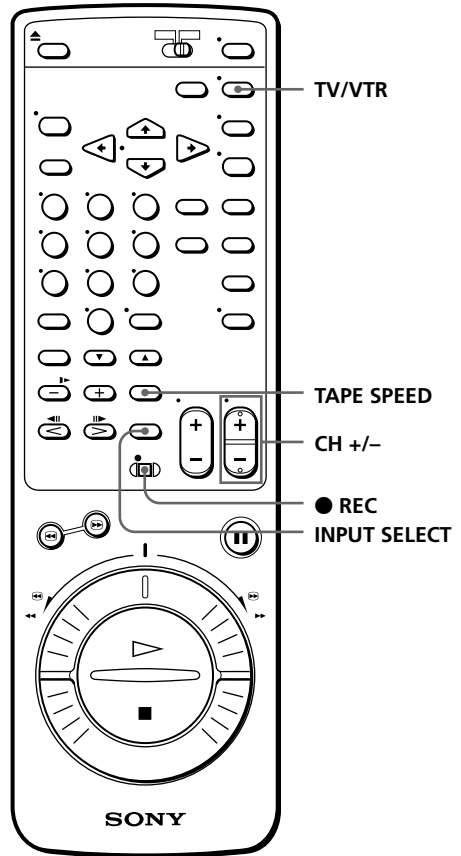
# Recording TV programs



- 1** Turn on your TV and set it to the video channel.  
To record from a cable box, turn it on.
- 2** Insert a tape with its safety tab in place.
- 3**  Press INPUT SELECT until a channel number appears in the display window.

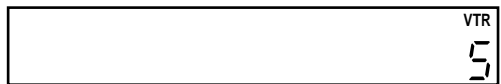

4



Press CH +/- to select the channel you want to record.



5

TAPE SPEED



Press TAPE SPEED to select the tape speed, SP or EP.

EP provides recording time three times as long as SP, however, SP produces better picture quality.



6



Press ● REC to start recording.

### To stop recording

Press ■ STOP.

### To check the remaining tape length

Press DISPLAY during playback or recording. The white bar indicates the approximate length of tape remaining.



### To watch another TV program while recording

- 1 Press TV/VTR to turn off the VTR indicator in the display window.
- 2 If the TV is connected to the VCR's LINE OUT jacks, set the TV to TV input; if not, skip this step.
- 3 Select another channel on the TV.

continued

---

## Recording TV programs (continued)

### To save a recording

To prevent accidental erasure, break off the safety tab as illustrated. To record on a tape again, cover the tab hole with adhesive tape.



### Tips

- To select a channel, you can use the number buttons on the remote commander. Enter the channel number, then press ENTER.
- To cut out an unwanted scene while recording, press ■ PAUSE and turn the DUAL MODE SHUTTLE ring on the VCR to rewind the tape to the beginning of the unwanted scene, then press ■ PAUSE to resume recording.
- The display appears on the TV screen indicating information about the tape, but the information won't be recorded on the tape.
- If you don't want to watch TV while recording, you can turn off the TV. When using a cable box, make sure to leave it on.

### Notes

- The remaining tape length may not be indicated accurately for short tapes such as T-20 or T-30, or tapes recorded in the LP mode.
- The display does not appear during still (pause) mode or slow-motion playback.
- It may take up to one minute for the VCR to calculate and display the remaining tape length after you press DISPLAY.



# Recording TV programs using VCR Plus+

Just enter the program's PlusCode listed in the TV program guide. The date, times and channel number of that program are set automatically. You can preset up to eight programs at a time.

## Before you start...

- Check that the VCR clock is set to the correct time.
- Turn on your TV and set it to the video channel. When using a cable box, turn it on.
- Insert a tape with its safety tab in place. Make sure the tape is longer than the total recording time.

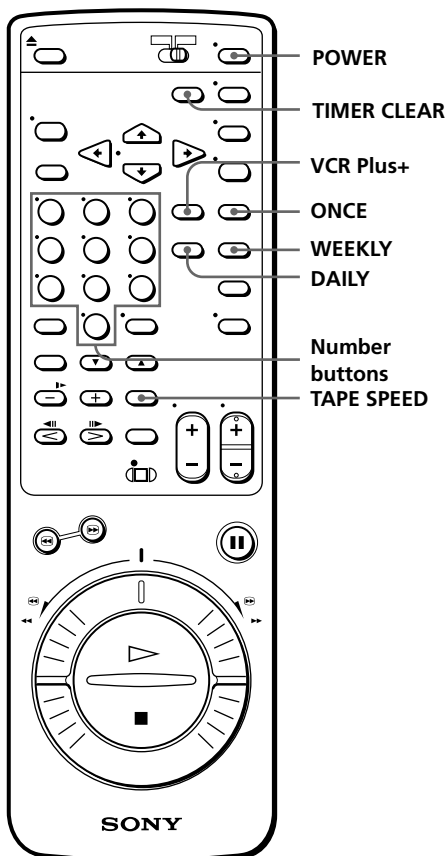

**1** VCR Plus+ Press VCR Plus+.



VCR Plus+	
PLUSCODE	TAPE SPEED
[-----]	[SP]
SET	: [0-9] keys
SP / EP	: [TAPE SPEED]

**2** Press the number buttons to enter the program's PlusCode. If you make a mistake, press TIMER CLEAR and re-enter the correct number.

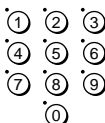

VCR Plus+	
PLUSCODE	SP / EP
[53292---]	[SP]
CONFIRM	: [ONCE], [DAILY], [WEEKLY]
CANCEL	: [TIMER CLEAR]

**continued**

## Recording programs using VCR Plus+ (continued)

**3** TAPE SPEED Press TAPE SPEED to select SP or EP.



VCR Plus+	
PLUSCODE [53292----	SP / EP [ EP ]
CONFIRM : [ ONCE ], [ DAILY ], [ WEEKLY ]	
CANCEL : [ TIMER CLEAR ]	

**4** ONCE Press ONCE, DAILY or WEEKLY:



or



or



WEEKLY



To record	Press
Only once	ONCE
Everyday Monday to Friday	DAILY
Once a week	WEEKLY

VCR Plus+	
PLUSCODE [53292----	SP / EP [ EP ]
RECORDING TIME	
DATE	START STOP CH
9 / 25 MON	8 : 00 PM 11 : 30 PM 52 EP
CANCEL : [ TIMER CLEAR ]	

The date, start and stop times, channel number and tape speed appear on the TV screen. If the information is not correct, press **TIMER CLEAR** to cancel the setting.

**5** To enter another setting, repeat steps 1 to 4.

**6** **POWER** Press **POWER** to turn off the VCR.



The **TIMER** indicator on the VCR lights up and the VCR stands by for recording. When using a cable box, leave it on.

### To stop recording

To stop the VCR while recording, press **STOP**.

---

### To use the VCR after setting the timer

To use the VCR before a timer recording begins, just press POWER. The "TIMER" indicator turns off and the VCR switches on. Remember to press POWER to reset the VCR in timer recording standby after using the VCR.

You can also do the following tasks while the VCR is recording:

- Reset the counter.
- Display tape information on the TV screen.
- Check the timer settings.
- Watch another TV program.

### Tip

- To cancel the procedure, press VCR Plus+ before pressing ONCE, DAILY or WEEKLY.

### Note

- If the VCR beeps, this means that:
  - The PlusCode is incorrect.
  - ONCE, DAILY or WEEKLY was selected incorrectly. You cannot select DAILY or WEEKLY for a program that airs more than seven days ahead.

# Setting the timer manually

If VCR Plus+ is not available in your area, follow the instructions below to set the timer to record programs.

## Before you start...

- Check that the VCR clock is set to the correct time.
- Turn on your TV and set it to the video channel. When using a cable box, turn it on.
- Insert a tape with its safety tab in place. Make sure the tape is longer than the total recording time.

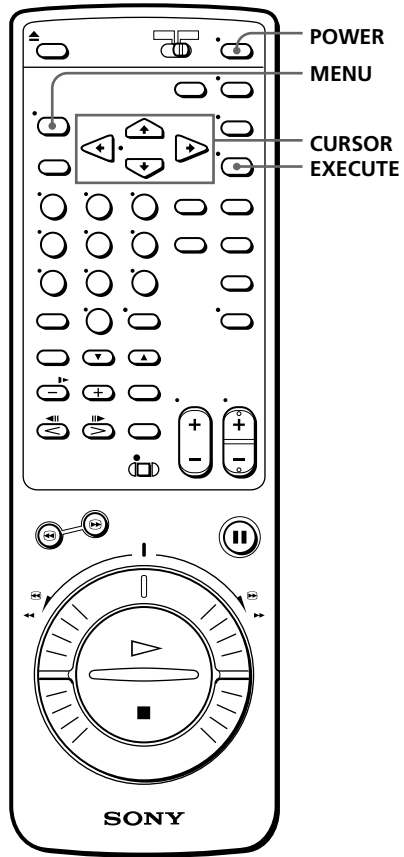

1



Press MENU and select TIMER SET / CHECK.

TIMER SET / CHECK	10 / 16	WED	
DATE	START	STOP	CH
▶ / --	--:--	--:--	--
-- / --	--:--	--:--	--
-- / --	--:--	--:--	--
-- / --	--:--	--:--	--
-- / --	--:--	--:--	--
-- / --	--:--	--:--	--
-- / --	--:--	--:--	--
-- / --	--:--	--:--	--

2

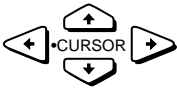

Set the date, start and stop times, channel number and tape speed:

1 Press CURSOR → to flash each item in turn.

2 Press CURSOR ↑/↓ to set each item.

To correct a setting, press CURSOR ← to return to that setting and reset.

To record the same program every day or the same day every week, press CURSOR ↓ while the date is flashing. For details, see "Daily/weekly recording" below.

To record from a source connected to the LINE-1 IN or LINE-2 IN jacks, press INPUT SELECT to display "L1" or "L2" in the "CH" position.

TIMER SET / CHECK	10 / 16	WED	CH	SP
DATE	START	STOP	CH	SP
10 / 16 WED	- : -	- : -	-	SP
3 / 3 3 3	- : -	- : -	-	-
- / -	- : -	- : -	-	-
- / -	- : -	- : -	-	-
- / -	- : -	- : -	-	-
- / -	- : -	- : -	-	-
- / -	- : -	- : -	-	-

3

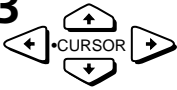

Press CURSOR → to confirm the setting.

The cursor (▶) appears at the top of the line. To enter another setting, move the cursor to the next line and repeat step 2.

4



Press EXECUTE.

5



Press POWER to turn off the VCR.

The TIMER indicator on the VCR lights up and the VCR stands by for recording.

When using a cable box, leave it on.

### Daily/weekly recording

In step 2 above, press CURSOR ↓ to select the recording pattern. Each time you press CURSOR ↓, the indication changes as shown below. Press CURSOR ↑ to change the indication in reverse order.

the current date → SUN-SAT → MON-SAT → MON-FRI → EVERY SAT →  
 ..... → EVERY MON → EVERY SUN → 1 month later → (cycles backward)  
 → the current date

### Tips

- To set the channel, you can also use the CH+/- or number buttons.
- To set the tape speed, you can also use the TAPE SPEED button.

# Playing/searching at various speeds

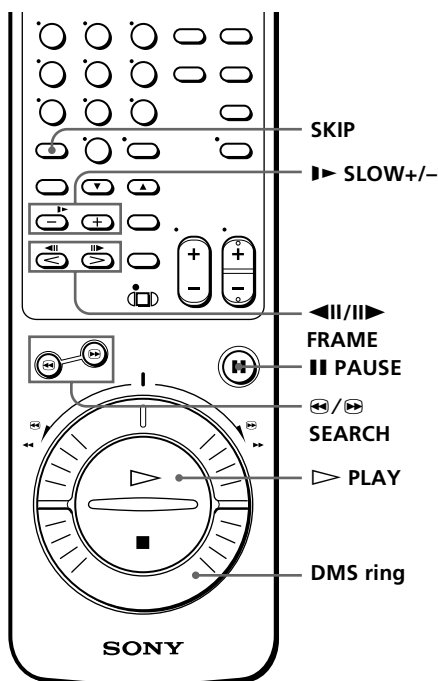

Playback options	Operation
Play at various speeds	During playback, turn the DMS ring and hold at the speed you want.
Fast-forward/rewind	During stop, turn the DMS ring to ▶▶FF or ◀◀REW and release.
View the picture during fast-forward or rewind	During fast-forward, turn the DMS ring to ▶▶FF. During rewind, turn the DMS ring to ◀◀REW.
Play at twice the normal speed	During playback, turn the DMS ring to x2
Play at high speed	During playback or pause, press ◀◀SEARCH or ▶▶SEARCH. To change direction, press    ▶FRAME or ◀◀   FRAME.
Play in slow motion	During playback or pause, press ▶▶SLOW+/- . Press the +/- buttons to change the speed. To change direction, press    ▶FRAME or ◀◀   FRAME.
Play frame by frame	During pause, press    ▶FRAME or ◀◀   FRAME. Hold the button down to play one frame each second.
Play in reverse	During playback, press ◀◀   FRAME.
Skip a scene	During playback, press SKIP. Pressing once skips about a minute.
Rewind and start play	During stop, press ▶▶PLAY on the VCR while holding the DMS ring on the VCR at the ◀◀REW position.

---

## To resume normal playback

Press ▷ PLAY.

### Tip

- Adjust the picture using the ▼/▲ TRACKING/STILL ADJUST buttons if:
  - Streaks appear while playing in slow motion.
  - Bands appear at the top or bottom while pausing.
  - The picture shakes while pausing.

### Notes

- The sound is muted during these operations.
- Tapes recorded in the LP mode on other VCRs can be played back on this VCR but the picture quality cannot be guaranteed.

# Recording TV programs using the quick timer

After starting recording in the normal way, you can have the VCR stop recording automatically after a specified duration.

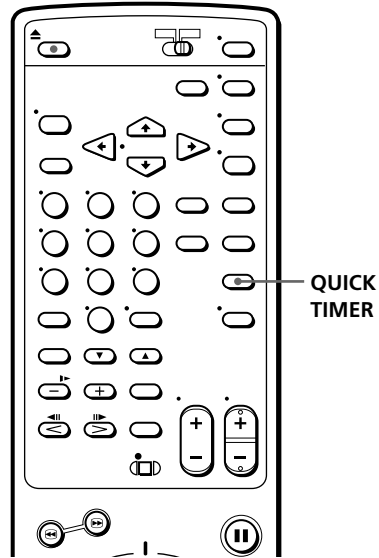

- 1 While recording, press QUICK TIMER once.

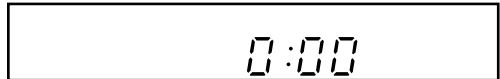

- 2 Press QUICK TIMER repeatedly to set the duration.  
Each press advances the time in increments of 30 minutes.

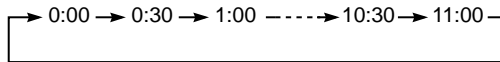

The duration decreases minute by minute to 0:00, then the VCR stops recording and turns off automatically.

## To extend the duration

Press QUICK TIMER repeatedly to set to the new duration.

## To stop the VCR while recording

Press ■ STOP.

## Tip

- You can also set the quick timer and start recording during the stop mode.



# Checking/ changing/ cancelling timer settings

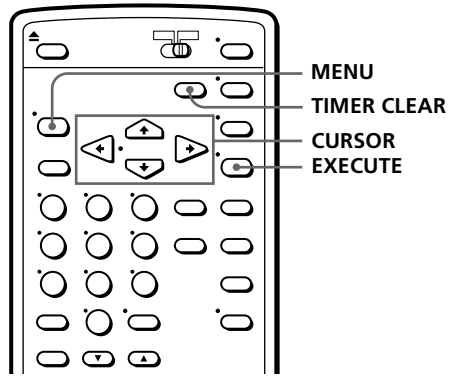

## Before you start...

- Turn on your TV and set it to the video channel.

- 1 Press POWER to turn on the VCR.
- 2 Press MENU and select TIMER SET/CHECK:

- If you want to change a setting, go on to the next step.
- If you do not need to change the settings, press EXECUTE, then turn off the VCR to return to recording standby.

TIMER SET / CHECK	10 / 16	WED	
DATE	START	STOP	CH
▶ 10 / 17 THU	7 : 00 AM	8 : 00 AM	6 SP
10 / 25 FRI	10 : 20 PM	11 : 15 PM	50 EP
MON - SUN	1 : 00 PM	3 : 00 PM	LINE1 EP
EVERY	SUN 11 : 50 AM	1 : 30 PM	40 SP
- / - / -	- : - -	- : - -	- - -
- / - / -	- : - -	- : - -	- - -
- / - / -	- : - -	- : - -	- - -
- / - / -	- : - -	- : - -	- - -

- 3 Press CURSOR **↑/↓** to select the setting you want to change or cancel:
  - To change the setting, press CURSOR **←/→** to flash the item you want to change, and press CURSOR **↑/↓** to reset it. Then, press CURSOR **→** repeatedly until the cursor (▶) appears at the top of the line.
  - To cancel the setting, press TIMER CLEAR.
- 4 Press EXECUTE.

If any timer settings remain, turn off the VCR to return to recording standby.

## When the timer settings overlap

The program that starts first has priority and the second program starts recording only after the first program has finished. If the programs start at the same time, the program listed first in the menu has priority.

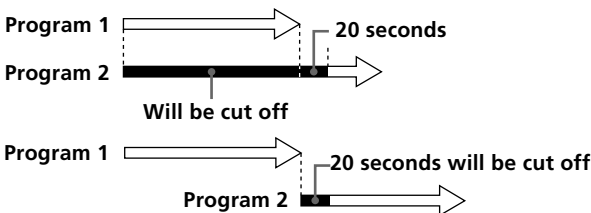

---

# Recording stereo and bilingual programs

## Recording stereo programs

This VCR automatically receives and records stereo programs. When a stereo program is received, the STEREO indicator lights up. If there is noise in the stereo program, set AUTO STEREO in the ADVANCED OPTIONS menu to OFF. The sound will be recorded in monaural (on both hi-fi and normal audio tracks) but with less noise. For details, see page 53.

## Recording bilingual programs

Normally, this VCR records only the main sound on both hi-fi and normal audio tracks. To record SAP (Second Audio Program) sound on the normal audio track, set NORMAL AUDIO in the ADVANCED OPTIONS menu to SAP (the SAP indicator lights up). For details, see page 53.

### To select the bilingual sound while recording

Press AUDIO MONITOR to select the sound you want.

### Selecting the sound during playback

Press AUDIO MONITOR to select the sound you want.

To listen to	On-screen display	Display window
Stereo/main (left and right channels)	STEREO	STEREO
Left channel only	LEFT CH	STEREO
Right channel only	RIGHT CH	STEREO
Monaural (SAP)	No indicator	No indicator

---

## How sound is recorded on a video tape

The VCR records sound onto two separate tracks. Hi-fi audio is recorded onto the main track along with the picture. Monaural sound is recorded onto the normal audio track along the edge of the tape.

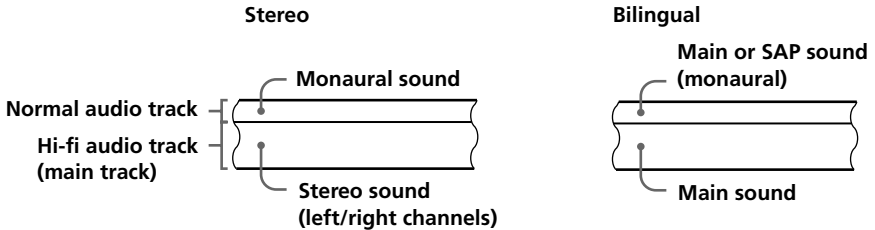

### Notes

- To play a tape in stereo, you must use the A/V connections.
- When you play a tape recorded in monaural, the sound is heard in monaural regardless of the AUDIO MONITOR setting.
- If the AUDIO MONITOR button does not function, check that AUDIO MIX in the ADVANCED OPTIONS menu is set to OFF.
- Set NORMAL AUDIO to MAIN when not recording SAP sound, or no sound is recorded on the normal audio track. If no sound is recorded on the normal audio track and you play the tape on a mono VCR, you will see only video — no audio will be heard.

# Adjusting the picture

## Adjusting the tracking

Although the VCR automatically adjusts the tracking when playing a tape (the AUTO TRACKING indicator flashes in the display window, then lights steadily), distortion may occur if the tape was recorded in poor condition. If so, manually adjust the tracking.

Press the ▼/▲TRACKING NORMAL/SLOW buttons to display the tracking meter. The distortion should disappear as you press one of the two buttons. If you cannot get a clear picture with manual adjustment, press TRACKING AUTO/MANUAL to return to automatic adjustment.

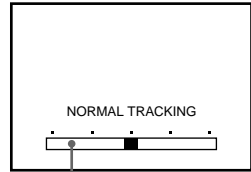

Tracking meter

## About Adaptive Picture Control (APC)

Adaptive Picture Control (APC) automatically improves recording and playback quality by adjusting the VCR to the condition of the video heads and tape. To maintain better picture quality, we recommend that you set APC to ON in the ADVANCED OPTIONS menu (with the APC indicator in the display window lit).

### APC playback

The APC function automatically works on all types of tapes, including rental tapes and tapes that were not recorded with APC.

### APC recording

Whenever you insert a tape and first start recording, the VCR adjusts to the tape using the APC function (the APC indicator flashes rapidly). This adjustment is retained until the tape is ejected.

#### Notes

- Auto tracking adjustment cannot be used on tapes recorded in the LP mode on other VCRs.
- There is a delay of a few seconds before the VCR actually starts recording while the VCR analyzes the tape. To avoid the delay, first set the VCR to recording pause (the APC indicator flashes slowly) and press ● REC to have the VCR analyze the tape (the APC indicator flashes rapidly). After the APC indicator stops flashing, press ■ PAUSE to start recording immediately.

If you want to start recording quickly without using the APC function, first set the VCR to recording pause (the APC indicator flashes slowly) and press ■ PAUSE to start recording.

# Changing menu options

- 1 Press MENU and select ADVANCED OPTIONS.

ADVANCED OPTIONS		
▶AUTO ANT SEL	•ON	OFF
AUTO STEREO	•ON	OFF
DIMMER	ON	•OFF
AUDIO MIX	ON	•OFF
NORMAL AUDIO	•MAIN	SAP
APC	•ON	OFF
SELECT	: [↕↔]	
SET	: [↔↕]	

- 2 Press CURSOR ↑/↓ to select the option to change, then press CURSOR ←/→ to change the setting.
- 3 Press EXECUTE to return to the original screen.

## Menu choices

Initial settings are indicated in bold print.

Menu option	Set this option to
AUTO ANT SEL	<b>ON</b> if your TV is connected only to VHF/UHF OUT on the VCR. To play a tape, set the TV to the VCR channel (channel 3 or 4). <b>OFF</b> if your TV is connected to both VHF/UHF OUT and LINE OUT on the VCR. To play a tape, set the TV to the VCR input.
AUTO STEREO	<b>ON</b> to receive stereo programs, <b>OFF</b> to reduce noise. The sound changes to monaural.
DIMMER	ON to make the display window dim, <b>OFF</b> to make it brighter.
AUDIO MIX	ON to listen to the sound recorded on hi-fi and normal audio tracks at the same time. The AUDIO MONITOR button will not function. <b>OFF</b> to listen to hi-fi and normal audio tracks separately. Select the sound using the AUDIO MONITOR button.
NORMAL AUDIO	<b>MAIN</b> to record the main sound on both hi-fi and normal audio tracks. <b>SAP</b> to record the SAP (Second Audio Program) sound on the normal audio track. The main sound is recorded on the hi-fi audio track.
APC	<b>ON</b> to switch on the APC (Adaptive Picture Control) function and improve picture quality, <b>OFF</b> to switch off APC.

# Hooking up to a VCR or stereo system

## How to hook up to record on this VCR

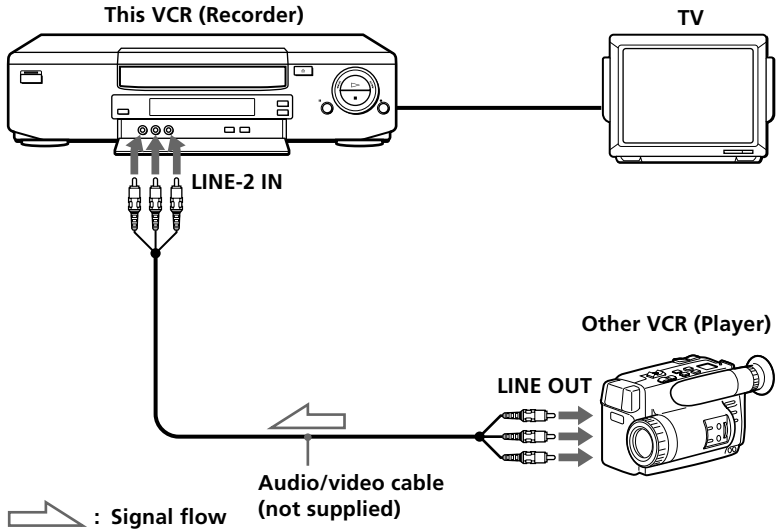

### Notes

- Make sure you connect the plugs to jacks of the same color.
- If the other VCR is a monaural type, leave the red plugs unconnected.
- If you connected this VCR to both the LINE IN and LINE OUT jacks of the other VCR, select the input correctly to prevent a humming noise.
- You can also use the LINE-1 IN jacks instead.

## How to hook up to a stereo system

Connect LINE-2 IN AUDIO on this VCR to the audio output jacks on the stereo system, using the RK-C510KS audio cable (not supplied).

## Operation (when recording on this VCR)

### Before you start editing

- Turn on your TV and set it to the video channel.
- Press INPUT SELECT to display “L2” in the display window.
- Press TAPE SPEED on the remote commander to select the tape speed, SP or EP.

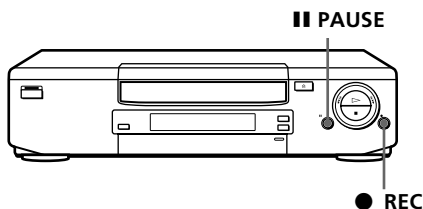

- 1** Insert a source tape with its safety tab removed into the other (playback) VCR. Search for the point to start playback and set it to playback pause.
- 2** Insert a tape with its safety tab in place into this (recording) VCR. Search for the point to start recording and press **II PAUSE**.
- 3** Press **● REC** on this VCR and set it to recording pause.
- 4** To start editing, press the **II PAUSE** buttons on both VCRs at the same time.

### To stop editing

Press the **■ STOP** buttons on both VCRs.

### Tips

- To edit more precisely, press the **II PAUSE** buttons on the VCRs to release pause.
- To cut out unwanted scenes while editing, press **II PAUSE** on this VCR when an unwanted scene begins. When it ends, press **II PAUSE** again to resume recording (Assemble Editing).

### Note

- If you start recording following the procedure above, the VCR won't start recording with the APC function. To record a tape with the APC function, press **● REC** again during recording pause in step 3 so that the VCR analyzes the tape. Then when you start recording in step 4, press **II PAUSE** immediately after the APC indicator stops flashing. If you press **II PAUSE** before the APC indicator stops flashing, the APC function is canceled.

# General setup information

## Setting the RF unit

When connecting the VCR to the TV using only an antenna cable, you must set the RF UNIT switch on the rear of the VCR so that the TV can receive the correct signal from the VCR.

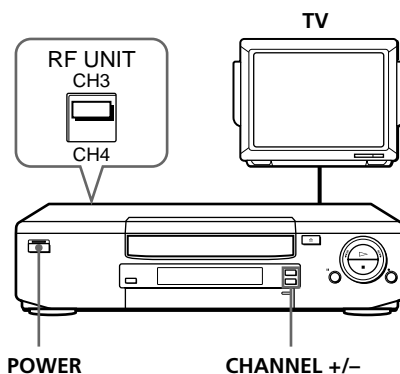

- 1** Set the RF UNIT switch on the rear of the VCR to CH3 or CH4, whichever channel is not used in your area. If both are used, set the switch to either channel.
- 2** Press POWER to turn on the VCR.
- 3** Press TV/VTR on the remote commander to turn on the VTR indicator in the VCR's display window.
- 4** Press CHANNEL +/- to display a channel number in the display window. Select an active channel number in your area.
- 5** Turn on your TV and set it to the channel you selected in step 1 (channel 3 or 4).

The selected TV channel broadcast appears on the TV screen. If the channels change when you press CHANNEL +/- on the VCR, you have made the correct setting.

Whenever you use the VCR, set the TV to the channel selected in step 1.



## Attaching the external antenna connector

When using a 300-ohm twin lead cable for VHF/UHF antenna, use the EAC-32 antenna connector (not supplied) to connect the antenna to the VCR.

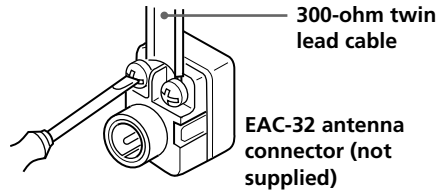

- 1** Loosen the screws on the antenna connector.
- 2** Wind the twin leads around the screws on the antenna connector.
- 3** Retighten the screws.

## Attaching a UHF/VHF band mixer

When using both 75-ohm coaxial cable and 300-ohm twin lead cable for VHF/UHF antenna, use the EAC-66 UHF/VHF band separator/mixer (not supplied) to connect the antenna to the VCR.

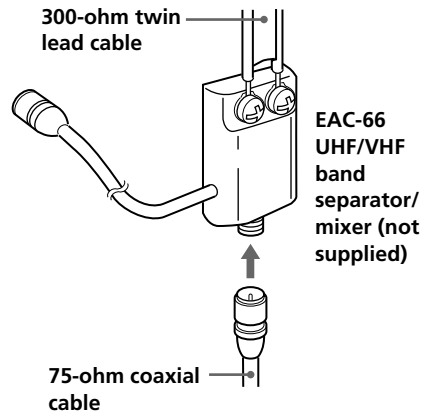

- 1** Loosen the screws on the mixer.
- 2** Wind the twin leads around the screws on the mixer.
- 3** Retighten the screws.
- 4** Connect the 75-ohm coaxial cable to the mixer.

# Troubleshooting

If you have any questions or problems not covered below, please consult your nearest Sony dealer.

	Symptom	Remedy
Power	The POWER switch does not function.	<ul style="list-style-type: none"> <li>Connect the AC power cord securely.</li> </ul>
	The power is turned on but the VCR does not operate.	<ul style="list-style-type: none"> <li>Moisture condensation occurs. Turn the power off, unplug the AC power cord and leave the VCR to dry for over an hour.</li> </ul>
Clock	The clock has stopped and “-:-” lights in the display window.	<ul style="list-style-type: none"> <li>The clock stops if the VCR is disconnected from the wall outlet for more than three hours. Reset the clock (and timer).</li> </ul>
	The playback picture does not appear on the TV screen.	<ul style="list-style-type: none"> <li>Make sure the TV is set to the channel for the VCR. If you are using a monitor, set it to video input.</li> </ul>
Playback	The picture is not clear.	<ul style="list-style-type: none"> <li>Adjust the tracking with the ▼/▲ TRACKING NORMAL/SLOW buttons.</li> <li>The video heads are dirty (see below). Clean the video heads using the Sony T-25CL video head cleaning cassette. If this cleaning cassette is not available in your area, have the heads cleaned at your nearest Sony service facility (a standard service charge will be required). Do not use a commercially available wet-type cleaning cassette, as it may damage the video heads.</li> <li>The video heads may have to be replaced. Consult your local Sony dealer for more information.</li> </ul>
	The picture rolls vertically during picture search.	<ul style="list-style-type: none"> <li>Adjust the vertical hold control on the TV or monitor.</li> </ul>
	The picture has no sound.	<ul style="list-style-type: none"> <li>The tape is defective. Use a new tape.</li> </ul>
	Both main and SAP sounds are heard.	<ul style="list-style-type: none"> <li>When you play a bilingual tape, make sure the AUDIO MIX option in the ADVANCED OPTIONS menu is set to OFF.</li> </ul>

## Symptoms caused by contaminated video heads

- Normal picture
- Rough picture
- Unclear picture
- No picture (or black & white screen appears)



initial → terminal

	Symptom	Remedy
Recording	A TV program does not appear on the TV screen.	<ul style="list-style-type: none"> <li>• Make sure the TV is set to the channel for the VCR. If you are using a monitor, set it to video input.</li> </ul>
	TV reception is poor.	<ul style="list-style-type: none"> <li>• Adjust the TV antenna.</li> </ul>
	The tape starts playing as soon as it is inserted.	<ul style="list-style-type: none"> <li>• The safety tab has been removed. To record on this tape, cover the tab hole.</li> </ul>
	The tape ejects when you press ● REC.	<ul style="list-style-type: none"> <li>• Check that the safety tab has not been removed.</li> </ul>
	Nothing happens when you press ● REC.	<ul style="list-style-type: none"> <li>• Make sure the tape is not at its end.</li> <li>• Select the correct source with the INPUT SELECT button. Select a channel number when recording TV programs; select "L1" or "L2" when recording from other equipment.</li> </ul>
Timer recording	No sound is recorded on the normal audio track.	<ul style="list-style-type: none"> <li>• When not recording SAP sound, make sure the NORMAL AUDIO option in the ADVANCED OPTIONS menu is set to MAIN.</li> </ul>
	The timer does not operate.	<ul style="list-style-type: none"> <li>• Check that the clock is set.</li> <li>• Make sure a tape has been inserted.</li> <li>• Check that the safety tab has not been removed.</li> <li>• Make sure the tape is not at its end.</li> <li>• Make sure a program has been set for timer recording.</li> <li>• Make sure your timer settings have not passed the current time.</li> <li>• Check that the cable box is turned on.</li> <li>• The clock stops if the VCR is disconnected from the wall outlet for more than three hours. Reset the clock and timer.</li> </ul>
Others	A tape cannot be inserted.	<ul style="list-style-type: none"> <li>• Check that a tape isn't in the tape compartment.</li> </ul>
	The remote commander does not function.	<ul style="list-style-type: none"> <li>• Make sure you are pointing the remote commander at the remote sensor on the VCR.</li> <li>• Replace all the batteries in the remote commander with new ones if they are weak.</li> </ul>
	The tracking indicator does not appear on the screen.	<ul style="list-style-type: none"> <li>• The recording condition of the tape is very poor and tracking cannot be adjusted.</li> </ul>
	You cannot control other TVs.	<ul style="list-style-type: none"> <li>• Set your TV's code number. The code number resets to 01 when you replace the batteries of the remote commander.</li> </ul>
	The VCR needs to be cleaned.	<ul style="list-style-type: none"> <li>• Clean the cabinet, panel and controls with a dry, soft cloth, or a soft cloth slightly moistened with a mild detergent solution. Do not use any type of solvent, such as alcohol or benzene.</li> </ul>

# Specifications

## System

- Format
  - VHS NTSC standard
- Video recording system
  - Rotary head helical scanning FM system
- Video heads
  - Double azimuth four heads
- Video signal
  - NTSC color, EIA standards
- Tape speed
  - SP: 33.35 mm/s ( $1\frac{3}{8}$  inches/s)
  - EP: 11.11 mm/s ( $\frac{7}{16}$  inches/s)
  - LP: 16.67 mm/s ( $1\frac{1}{16}$  inches/s), playback only
- Maximum recording/playback time
  - 8 hrs. in EP mode (with T-160 tape)
- Fast-forward and rewind time
  - Approx. 3 min. (with T-120 tape)

## Tuner section

- Channel coverage
  - VHF 2 to 13
  - UHF 14 to 69
  - CATV A-8 to A-1, A to W, W+1 to W+84
- Antenna
  - 75-ohm antenna terminal for VHF/UHF

## Inputs and outputs

- LINE-1 IN and LINE-2 IN
  - VIDEO IN, phono jack (1 each)
    - Input signal: 1 Vp-p, 75 ohms, unbalanced, sync negative
  - AUDIO IN, phono jack (2 each)
    - Input level: 327 mVrms
    - Input impedance: more than 47 kilohms
- LINE OUT
  - VIDEO OUT, phono jack (1)
    - Output signal: 1 Vp-p, 75 ohms, unbalanced, sync negative
  - AUDIO OUT, phono jack (2)
    - Standard output: 327 mVrms
    - Load impedance: 47 kilohms
    - Output impedance: less than 10 kilohms

## Timer section

- Clock
  - Quartz locked
- Timer indication
  - 12-hour cycle
- Timer setting
  - 8 programs per month (max.)
- Power back-up
  - Built-in self-charging capacitor
  - Back-up duration: up to 3 hours at a time

## General

- Power requirements
  - 120 V AC, 60 Hz (SLV-760HF/761HF)
  - 110 V AC to 240 V AC, 50/60 Hz (SLV-760HF MJ/760HF PX)
- Power consumption
  - 27 W (max.) (SLV-760HF/761HF)
  - 24 W (max.) (SLV-760HF MJ/760HF PX)
- Operating temperature
  - 5°C to 40°C (41°F to 104°F)
- Storage temperature
  - 20°C to 60°C (-4°F to 140°F)
- Dimensions
  - Approx. 430 × 109 × 310 mm (w/h/d)
  - Approx. (17 × 4  $\frac{3}{8}$  × 12  $\frac{1}{4}$  inches) including projecting parts and controls
- Mass
  - Approx. 4.3 kg (9 lb 8 oz)

## Supplied accessories

- Remote commander (1)
- Size AA (R6) batteries (2)
- 75-ohm coaxial cable with F-type connectors (1)
- AC power cord (1)
- Audio/video cable (3 phono to 3 phono) (1)
- Plug adaptor (1) (SLV-760HF MJ/760HF PX)

Design and specifications are subject to change without notice.

# Index to parts and controls

Refer to the pages indicated in parentheses ( ) for details.

## Front panel

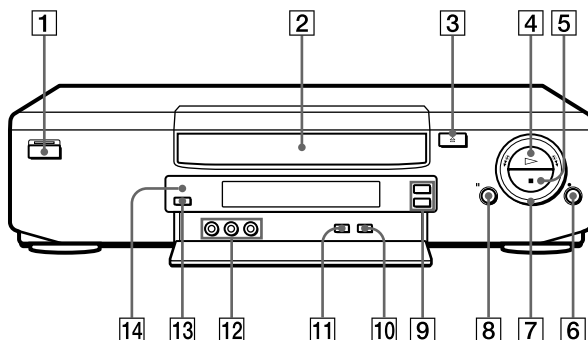

- |  |  |
|--|--|
| <b>1</b> POWER switch/indicator          | <b>8</b> <b>  </b> PAUSE button (37, 55)       |
| <b>2</b> Tape compartment                | <b>9</b> CHANNEL +/--buttons (31, 39)          |
| <b>3</b> <b>▲</b> EJECT button (37)      | <b>10</b> TAPE SPEED (SP/EP) button (39)       |
| <b>4</b> <b>▷</b> PLAY button (36)       | <b>11</b> INPUT SELECT button (38)             |
| <b>5</b> <b>■</b> STOP button (37, 39)   | <b>12</b> LINE-2 IN VIDEO/AUDIO L/R jacks (54) |
| <b>6</b> <b>●</b> REC button (39, 55)    | <b>13</b> TV/VTR button (39)                   |
| <b>7</b> DUAL MODE SHUTTLE ring (37, 46) | <b>14</b> Remote sensor (5)                    |

**continued**

## Index to parts and controls (continued)

### Display window

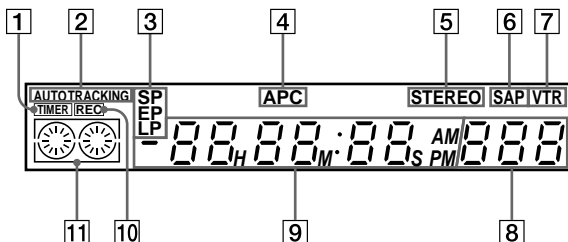

- |   |                              |    |                                   |
|---|------------------------------|----|-----------------------------------|
| 1 | TIMER indicator (45)         | 7  | VTR indicator (39)                |
| 2 | AUTO TRACKING indicator (52) | 8  | Line/channel indicator (38)       |
| 3 | Tape speed indicator (39)    | 9  | Time counter/clock indicator (37) |
| 4 | APC indicator (52)           | 10 | REC (recording) indicator         |
| 5 | STEREO indicator (50)        | 11 | Tape indicator                    |
| 6 | SAP indicator (50)           |    |                                   |

### Rear panel

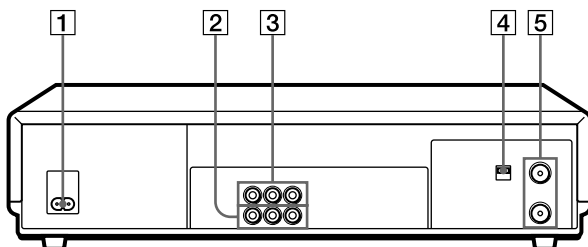

- |   |                                      |   |  |
|---|--------------------------------------|---|--|
| 1 | AC IN connector                      | 4 | RF UNIT switch (56)                        |
| 2 | LINE OUT AUDIO L/R/VIDEO jacks (8)   | 5 | VHF/UHF IN/OUT connectors (10, 13, 16, 19) |
| 3 | LINE-1 IN AUDIO L/R/VIDEO jacks (54) |   |  |

## Remote commander

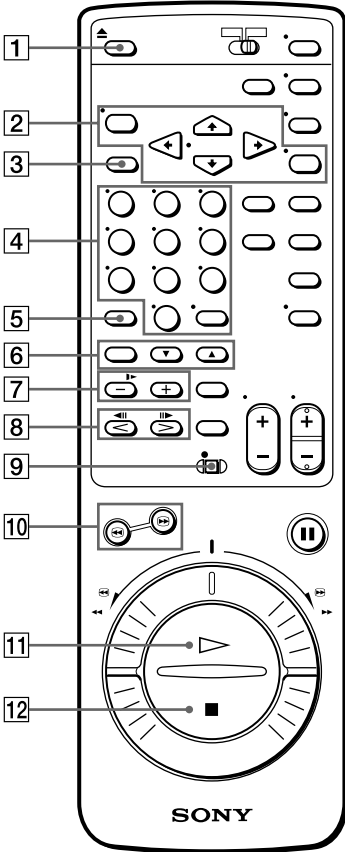

- 1 ▲ EJECT button (37)
- 2 Menu operation buttons (53)  
MENU button  
CURSOR ↑/↓/←/→ buttons  
EXECUTE button
- 3 COUNTER RESET button (37)
- 4 Channel number buttons and ENTER button (31, 34, 41)
- 5 SKIP button (46)
- 6 TRACKING buttons (52)  
▼/▲ NORMAL SLOW (STILL ADJUST) buttons  
AUTO/MANUAL button
- 7 ►► SLOW buttons (46)
- 8 ◀◀ / ▶▶ FRAME buttons (46)
- 9 ● REC button (38)
- 10 ◀◀ / ▶▶ SEARCH buttons (46)
- 11 ▷ PLAY button (36)
- 12 ■ STOP button (37)

**continued**

## Index to parts and controls (continued)

### Remote commander (continued)

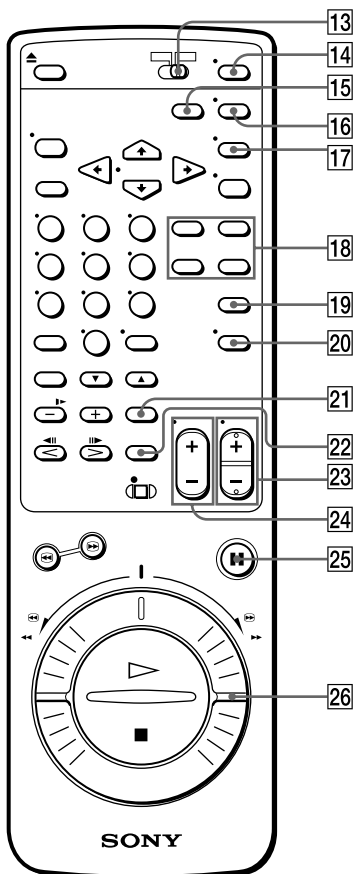

- 13 TV/VTR remote control switch (5, 6)
- 14 POWER switch
- 15 TIMER CLEAR button (41, 49)
- 16 TV/VTR button (39)
- 17 AUDIO MONITOR button (50)
- 18 VCR Plus+ buttons (41)
  - VCR Plus+ button
  - ONCE button
  - DAILY button
  - WEEKLY button
- 19 QUICK TIMER button (48)
- 20 DISPLAY button (37, 39)
- 21 TAPE SPEED button (39)
- 22 INPUT SELECT button (38)
- 23 CH +/- buttons (31, 39)
- 24 VOL +/- buttons
- 25 ■ PAUSE button (37)
- 26 DUAL MODE SHUTTLE ring (37, 46)



---

# Index

## A, B

- Accessories supplied 4
- Adjusting
  - picture 47
  - tracking 52
- AFT (Auto Fine Tuning) 32
- Antenna hookup 10
- APC (Adaptive Picture Control) 52
- Audio track 50
- Audio/video (A/V) hookup 8
- Auto Clock Set feature 23

## C

- Cable hookup 13
- Cleaning the video heads 58
- Cancelling timer settings 49
- Changing timer settings 49
- Channel line-up chart 33
- Clearing the video heads 58
- Clock setting 23
- Connecting
  - cable TV 13
  - external antenna connector 57
  - UHF/VHF band mixer 57
- Counter 37

## D

- Disabling channels 31
- Dubbing. *See* Editing.

## E, F, G

- Editing 55
- EP mode 39

## H, I, J, K

- Hi-fi audio track 51

## L

- LP mode 40, 47

## M

- Monitoring audio 50

## N, O

- Normal audio track 51

## P

- Picture adjustment. *See* Adjusting
- Playback 36
  - at various speeds 46
  - frame-by-frame 46
  - skip 46
  - slow motion 46
- Presetting channels 29

## Q

- Quick timer 48

## R

- Recording 38
  - bilingual programs 50
  - SAP broadcasts 50
  - saving 40
  - stereo broadcasts 50
  - using VCR Plus+ 41
  - while watching another program 40

## S

- Safety tab 40
- SAP (Second Audio Program) 50
- Searching at various speeds 46
- SP mode 39

## T, U

- Timer recording 44
  - cancelling timer settings 49
  - changing timer settings 49
  - checking timer settings 49
  - daily/weekly recording 45
  - overlapping timer recordings 49
  - using VCR Plus+ 41
- Tracking adjustment. *See* Adjusting

## V, W, X, Y, Z

- VCR Plus+ 41
  - channel setup 33
  - recording 41





# Quick reference to using the VCR

## Hookup 1

### To play a tape

- 1 Set the TV to channel 3 or 4 (or to video input, if you made A/V connections.)
- 2 Insert a tape and press **PLAY**. If there's no picture on your TV, press the VCR's TV/VTR button until the VTR indicator comes on in the display window.

### To record a program

- 1 Press VCR Plus+ on the remote commander.
- 2 Enter the program's PlusCode number.
- 3 Press ONCE, DAILY, or WEEKLY.
- 4 Insert a tape.
- 5 Press POWER to turn off the VCR.

### To watch TV

- 1 Turn off the VCR, or press the VCR's TV/VTR button until the VTR indicator in the display window goes off.
- 2 Set the TV to the channel you want to watch.

## Hookup 2

### To play a tape

- 1 Set the TV to channel 3 or 4 (or to video input, if you made A/V connections.)
- 2 Insert a tape and press **PLAY**. If there's no picture on your TV, press the VCR's TV/VTR button until the VTR indicator comes on in the display window.

### To record a program

- 1 Turn on the cable box.
- 2 Set the cable box to the channel you want to record.
- 3 Press VCR Plus+ on the remote commander.
- 4 Enter the program's PlusCode number.
- 5 Press ONCE, DAILY, or WEEKLY.
- 6 Insert a tape.
- 7 Press POWER to turn off the VCR.  
Leave the cable box on.

### To watch TV

- 1 Turn off your VCR, or press the VCR's TV/VTR button until the VTR indicator in the display window goes off.
- 2 Turn on your cable box.
- 3 Set the TV to the cable box output channel (usually 2, 3, or 4).
- 4 Set the cable box to the channel you want to watch.

## Hookup 3

### To play a tape

- 1 If you made A/V connections, set the TV to video input.  
If you didn't use A/V hookup:
  - Turn on the cable box.
  - Set the cable box to channel 3 or 4.
  - Set the TV to the output channel of the cable box (usually 2, 3 or 4).
- 2 Insert a tape and press **PLAY**.

### To record a program

- 1 Press VCR Plus+ on the remote commander.
- 2 Enter the program's PlusCode number.
- 3 Press ONCE, DAILY, or WEEKLY.
- 4 Insert a tape.
- 5 Press POWER to turn off the VCR.

### To watch TV

- 1 Turn off your VCR, or press the VCR's TV/VTR button until the VTR indicator in the display window goes off.
- 2 Select the channel with your cable box (if you have one) or with your TV.

If you have any questions about this product, you may call: **Sony Customer Information Center** 1-800-222-SONY (7669) or write to: **Sony Customer Information Center** Sony Drive, Mail Drop #T1-11, Park Ridge, NJ 07656