

Index

A, B

- Accessories supplied 4
- Adjusting
 - picture 34
 - tracking 34
 - volume 70
- Aerial hookup 7
- APC (Adaptive Picture Control) 34
- Audio dubbing 36
- Audio track 32
- AV connection 6

C

- Cleaning the video heads 62
- Colour system
 - compatible colour systems 2
 - setting 12
- Connecting
 - the player and your TV 6
 - to a TV with audio/video jacks 6
- Continuous play 17
- Counter 13

D

- Dubbing. *See* Editing

E, F, G

- Editing 30
- EP mode 29

H

- Handling CDs 61
- Hi-fi audio track 32

I, J

- Index
 - searching 33

K

- Karaoke sing along 23
 - Adding harmony 58
 - Backing up your singing 56
 - Grading your singing 59
 - Reducing the playback vocals 56

L

- Language selection 10
- Locating
 - a specific point 42
 - a specific scene 39
 - a specific track 42
 - using index 33
- LP mode 28

M

- Monitoring
 - during playback 26

N, O

- Normal audio track 32
- NTSC-recorded tapes 9

P, Q

- PBC functions 51
- Picture adjustment. *See* Adjusting
- Playback 11, 16
 - at various speeds 12, 17, 26
 - frame-by-frame 26
 - slow motion 26
- Program 48, 54
 - changing 50, 54
 - checking 50

R

- Recording 28
 - saving 29
- Remaining time 20
- Remote commander 5
- Resume Play 41

S

- Safety tab 29
- Scene Search 39
- Searching
 - at various speeds 12, 17, 26
 - with the index function 33
- Shuffle Play 47
- Slow-motion play 26
- SP mode 28

T, U, V, W, X, Y, Z

- Total playing time 19
- Tracking adjustment. *See* Adjusting
- TV system 9

Video CD Player/ Video Cassette Player

Operating Instructions

VHS

PAL NTSC

Hi-Fi

COMPACT
disc
DIGITAL VIDEO

COMPACT
disc
DIGITAL AUDIO

SLV-7000K CH/PS

WARNING

To prevent fire or shock hazard, do not expose the unit to rain or moisture.

To avoid electrical shock, do not open the cabinet. Refer servicing to qualified personnel only.

Laser component in this product is capable of emitting radiation exceeding the limit for Class 1.

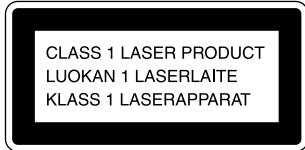

This appliance is classified as a CLASS 1 LASER product. The CLASS 1 LASER PRODUCT MARKING is located on the rear exterior.

The following caution label is located inside of the unit.

CAUTION	: INVISIBLE LASER RADIATION WHEN OPEN. AVOID EXPOSURE TO BEAM.
ADVARSEL	: USYNLIG LASERSTRÅLING VED ÅBNING NÅR SIKKERHEDSÅRBEJDENE ER LØSE AF FUNKTION. UNDGÅ UDØS JETTELSE FOR STRÅLING.
VARO!	: AVIHTÄMÄSSÄ JA SUOJAUMUTUS OVIETÄTTÄESSÄ OLET ALTIINA LASERBATEILYLLLE.
VARNING	: LASERSTRÅLING NÄR DENNA DEL ÄR ÖPPNAD OCH SPÅRRETT ÄR URKOPPLAD.
ADVARSEL	: USYNLIG LASERSTRÅLING NÄR DÖKSEL ÅPNES UNNGÅ EKSPONERING FOR STRÅLEN.

Caution

Television programmes, films, video tapes, and other materials may be copyrighted.

Unauthorized recording of such material may be contrary to the provisions of the copyright laws. Also, use of this recorder with cable television transmission may require authorization from the cable television transmitter and/or programme owner.

Compatible colour systems

This player is designed to record and play back using the PAL (B/G and D/K), MESECAM (B/G and D/K), and NTSC colour systems.

Recording of video sources based on other colour systems cannot be guaranteed.

Welcome!

Thank you for purchasing the Sony Video CD Player / Video Cassette Player. Before operating the unit, please read this manual thoroughly and retain it for future reference.

Table of contents

Getting Started

- 4 Step 1: Unpacking
- 5 Step 2: Setting up the remote commander
- 6 Step 3: Connecting
- 8 Step 4: Tuning your TV to this player
- 10 Step 5: Selecting a language

Basic Operations - VHS part

- 11 Playing a tape

Basic Operations - VCD part

- 15 The VCD part of this player can play the various discs
- 16 Playing a VIDEO CD/Audio CD
- 19 Using the display window

Basic Operations - Karaoke function

- 22 Before you start karaoke
- 23 Karaoke sing-along
- 25 Displaying the karaoke information

Enjoying Playback and Recording a Tape

- 26 Playing/searching at various speeds
- 28 Recording TV programmes
- 30 Editing with another VCR
- 33 Searching with the index function
- 34 Adjusting the picture
- 35 Changing menu options
- 36 Audio dubbing

Enjoying Playback of a VIDEO CD/Audio CD

- 39 Locating scenes directly using the scene numbers (Scene Search)
- 41 Resuming playback from the point you stopped a VIDEO CD (Resume Play)
- 42 Locating a particular point in a scene or track
- 45 Playing repeatedly
- 47 Playing in random order (Shuffle Play)
- 48 Creating your own programme (Programme Play)
- 51 Playing a VIDEO CD with PBC functions (PBC Playback)
- 53 Switching the sound

Enjoying Karaoke Sing-along

- 54 Programming the order of the songs
- 56 Using the various functions
- 60 Recording your karaoke singing

Additional Information

- 61 Precautions
- 62 Troubleshooting
- 64 Specifications
- 65 Index to parts and controls

Back cover

Index

Step 1

Unpacking

Check that you have received the following items with this player

- Remote commander

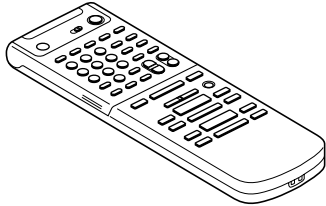

- Mains lead

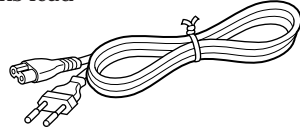

- R6 (Size AA) batteries

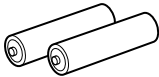

- Microphone

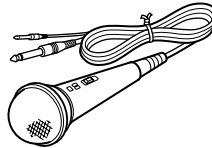

- Aerial cable

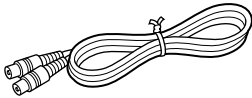

- Plug adaptor (SLV-7000K CH only)

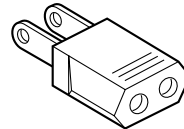

- Audio/video cable (3-phono to 3-phono)

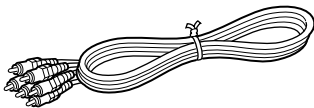

Checking your model name

The instructions in this manual are for the 2 models : SLV-7000K CH, 7000K PS. Check your model number by looking at the rear panel of your unit. The SLV-7000K CH is the model used for illustration purposes. Any difference in operation is clearly indicated in the text, for example, "SLV-7000K CH only."

Step 2

Setting up the remote commander

Inserting the batteries

Insert two R6 (size AA) batteries by matching the + and - on the batteries to the diagram inside the battery compartment.

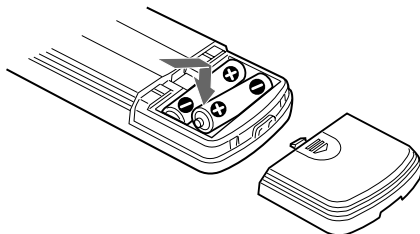

Using the remote commander

You can use this remote commander to operate this player and a Sony TV. Buttons on the remote commander marked with a dot (•) can be used to operate your Sony TV.

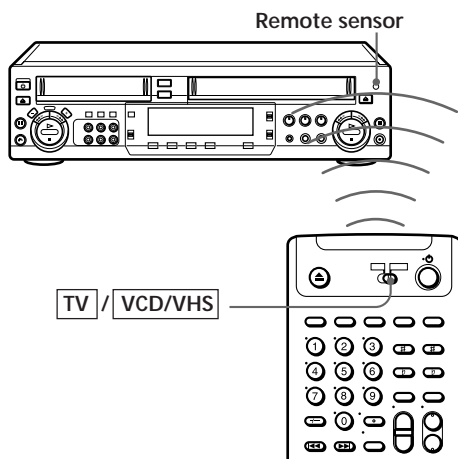

To operate	Set TV / VCD/VHS to
VCD/VHS	VCD/VHS and point at the remote sensor on this player
a Sony TV	TV and point at the remote sensor on the TV

Notes

- The TV/VIDEO button selects an input source of the TV from aerial in or line in. The button does not control this player.
- With normal use, the batteries should last about three to six months.
- If you do not use the remote commander for an extended period of time, remove the batteries to avoid possible damage from battery leakage.
- Do not use a new battery with an old one.
- Do not use different types of batteries.

Step 3

Connecting

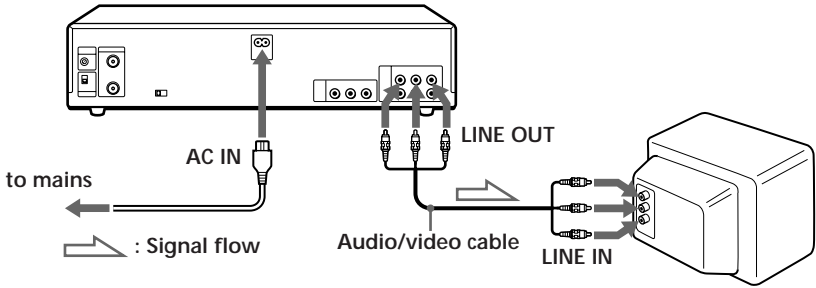

1

Connect LINE-1 OUT of this unit and the LINE IN of your TV using the supplied audio/video cable.

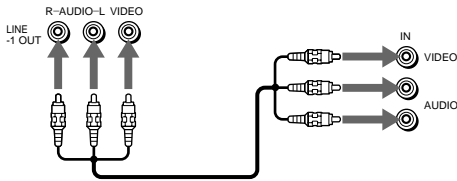

2

Connect AC IN of the unit to the mains using the supplied mains lead.

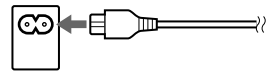

Additional connections

To a TV that does not have phono type audio/video input jacks

Connect the TV as shown on the right.

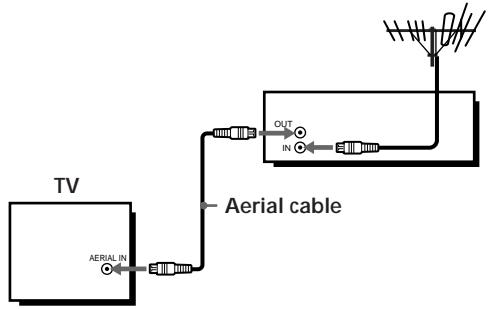

To a stereo system

When you enjoy a VCD and an audio CD, you can improve sound quality by connecting a stereo system as shown on the right.

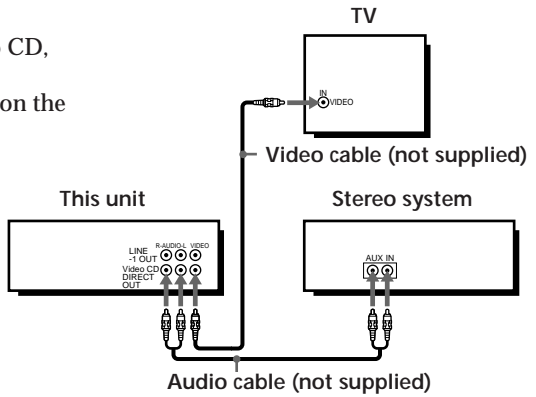

Step 4

Tuning your TV to this player

If you have connected this player to the TV using the audio/video cable, skip this step.

ON/STANDBY

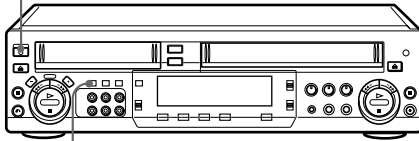

INPUT SELECT 1

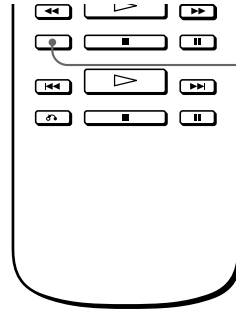

VHS
INPUT
SELECT

1



Press ON/STANDBY to turn on this player..

2



Press INPUT SELECT 1 (or press VHS INPUT SELECT on the remote repeatedly until "LINE1" appears).
INPUT SELECT 1 button lights up.

3

Turn on your TV and select a programme position for video playback.

Choose a channel between UHF 30 and 39 on the TV, where there is no picture and no sound or only a steady rustling sound.

This channel will now be referred to as the video channel.

4

Tune the TV so that a blue screen appears on the TV screen.
Refer to your TV manual for tuning instructions.

You have now tuned your TV to this player. From now on, whenever you want to play a tape, set the TV to the video channel.

If the blue screen does not appear clearly, see "To obtain a clear blue screen" on the next page.

To check to see if the TV tuning is correct

Set the TV to the video channel and press **PROG +/-** on the remote of this player. If the TV screen changes to a different programme each time you press **PROG +/-**, the TV tuning is correct.

To obtain a clear blue screen

If the blue screen does not appear clearly in step 4 above, turn the **RF CHANNEL** screw at the rear of this player with a screwdriver to a position where the TV clearly displays the blue screen.

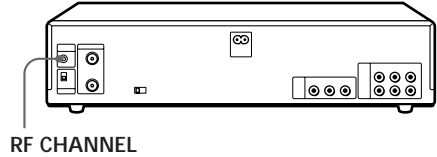

Selecting the TV system

For your TV to receive the correct signal from this player, you must set the **TV SYSTEM** switch at the rear of this player to either **G** (for system B/G) or **K** (for system D/K). If this switch is set to the wrong position, the sound will be distorted.

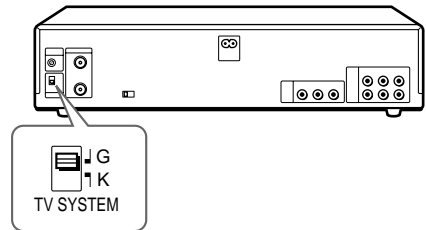

Selecting the NTSC PB switch

For your TV to receive the correct signal from this player, you must set the **NTSC PB** switch at the rear of this player. If this switch is set to the wrong position, the picture will be distorted.

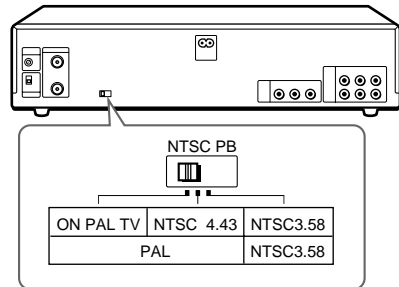

To play an NTSC-recorded tape

Set **NTSC PB** at the rear of this player according to the colour system of your TV.

If your TV is	Set NTSC PB (VHS/VCD) to
PAL	PAL / PAL
NTSC 4.43	4.43 NTSC/PAL
NTSC 3.58	NTSC/NTSC

Notes

- If you play a VCD whose colour system is different from the NTSC PB position (VCD) you selected, the size of the picture may not be correct.
- After you changed the NTSC PB position (VCD) of this switch, turn off the power once, then turn it on again.

Step 5

Selecting a language

You can change the on-screen language from English to Chinese.

Before you start...

- Turn on this player and the TV.
- Set the TV to the video channel.

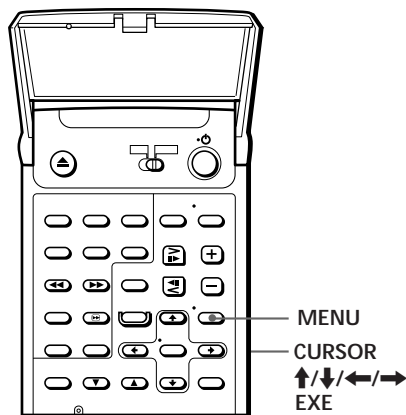

1



Press MENU.

MENU
▶KARAOKE RESERVE
SET UP MENU
SET UP VHS
LANGUAGE / 语言
SELECT : [◆◆]
SET : [EXECUTE]

2

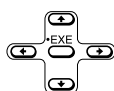

Press CURSOR ↑/↓ to move the cursor (▶) to LANGUAGE and press EXE.

LANGUAGE / 语言
▶ENGLISH
中文
SELECT : [◆◆]
END : [EXECUTE]

3

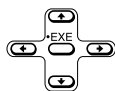

Press CURSOR ↑/↓ to select the desired language, then press EXE.

LANGUAGE / 语言
ENGLISH
▶中文
选择 : [◆◆]
完毕 : [EXECUTE]

Note

- The settings in the menu return to initial settings when you disconnect the mains lead.

Playing a tape

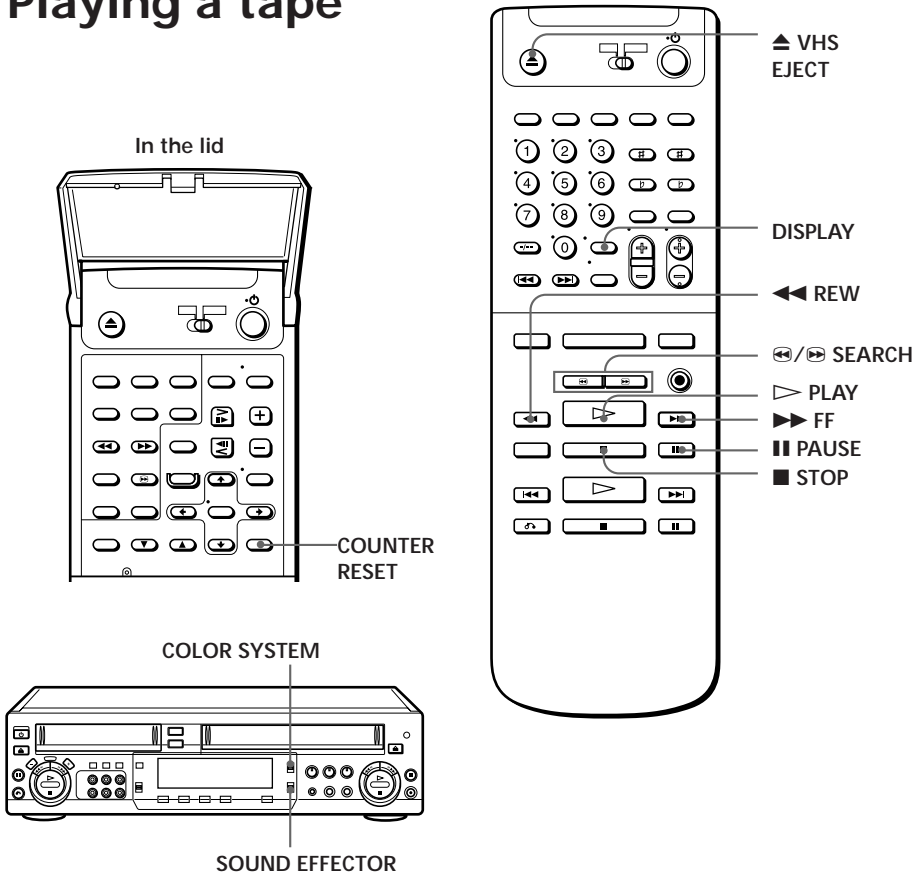

1 Turn on your TV and set it to the video channel.

2 Insert a tape.
The VHS part turns on and starts playing automatically if you insert a tape with its safety tab removed.

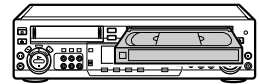

3 Press  **PLAY**.

When the tape reaches the end, it will rewind automatically.

continued

Playing a tape (continued)

Additional tasks

To	Press
Stop play	■ STOP
Pause play	PAUSE
Resume play after pause	PAUSE or ▷ PLAY
Search forward	▶▶ FF or 🔍 SEARCH during playback
Search backward	◀◀ REW or 🔍 SEARCH during playback
Fast-forward the tape	▶▶ FF during stop
Rewind the tape	◀◀ REW during stop
Eject the tape	▲ EJECT

To set the colour system

If streaks appear during playback, set COLOR SYSTEM on this player to conform to the system that the tape was recorded in. (Normally set the switch to AUTO.)

If your tape was recorded in	Set COLOR SYSTEM to
PAL	PAL/MESECAM
NTSC	NTSC
MESECAM	PAL/MESECAM

Sound effect

You can use the surround sound effect. To activate the surround function, set the SOUND EFFECTOR switch to NORMAL.

To give a monaural source the effect of a stereo sound, set the SOUND EFFECTOR switch to STEREO. The STEREO function also works for monaural sound from LINE INPUT.

To cancel the surround sound effect

Set the SOUND EFFECTOR switch to OFF.

To use the time counter

At the point on the tape that you want to find later, press COUNTER RESET. The counter in the display window resets to “0H00M00S.” Search for the point afterwards by referring to the counter.



Using the on-screen display

You can check the operating status of the player and the information about the tape with the on-screen display on the TV screen.

Press DISPLAY.

Each time you press the button, the on-screen display changes as follows:

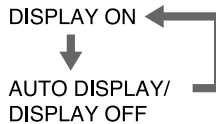

When AUTO DISPLAY is set to OFF under SET UP MENU in the menu system, the on-screen display changes DISPLAY ON and OFF each time you press DISPLAY.

Tip

- To change the output signal to LINE OUT to the VHS signal manually, press OUTPUT SELECT VHS.

Notes

- The counter resets to “0H00M00S” whenever a tape is reinserted.
- The counter stops counting when it comes to a portion with no recording.
- If a tape has portions recorded in both PAL and NTSC systems, the time counter reading will not be correct. This is due to the difference between the counting cycles of the two video systems.
- Depending on your TV, the following may occur while playing an NTSC-recorded tape:
 - the picture is black and white
 - the picture shakes
 - no picture appears on the TV screen
 - black streaks appear horizontally on the TV screen
 - the colour density increases or decreases.
- When the KARAOKE (ON/OFF) switch is set to on, this player displays the karaoke information (page 25).
- You need to press OUTPUT SELECT VHS button to select the VHS part before playing when OUTPUT SEL is set to NORMAL under SET UP MENU in the menu system.

continued

Playing a tape (continued)

Turning on this player and TV, and starting playback automatically (Trinitron TV Synchro Play)

You can only use this function if your TV is made by Sony (Trinitron TV).

How to connect to use this function

Connect this player and TV with the audio/video cable (see “Connecting” on page 6.) Be sure to connect the audio/video cable to the VIDEO IN 1 jacks on the TV if the TV has two inputs or more. The TV must be placed where it will respond to the remote commander while you are pointing it at this player.

Operation

Make sure that the TV's power is in standby mode.

Press TRINITRON TV SYNCHRO PLAY VHS and hold the remote commander in place for about two seconds.

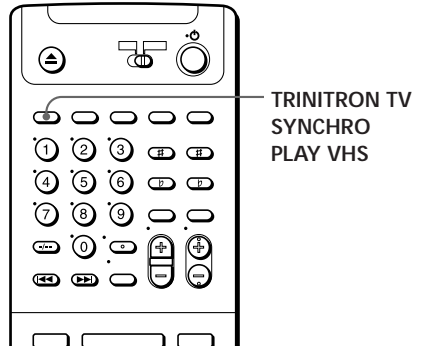

This player and TV turn on, and the TV is set to VCR reception. If there is a tape in this player, playback starts automatically.



Notes

- If the Trinitron TV Synchro Play function does not work properly:
 - Wait a few moments, and press the button again.
 - Replace both of the batteries with new ones, and press the button again.Note that this function may not operate some Sony TVs because of the remote commander's signal limitations.
- Do not press TRINITRON TV SYNCHRO PLAY VHS while playing back a video tape. If you do so, the TV's input source will momentarily switch to the TV's tuner.

The VCD part of this player can play the various discs

	VIDEO CDs	Audio CDs
Disc logo		
Contents	Audio + Video (moving pictures)	Audio
Disc size	12 cm/8 cm	12 cm/8 cm (CD single)
Play time	74 min./ 20 min.	74 min./ 20 min.

To play a VIDEO CD

See page 16.

To enjoy PBC Playback of a VIDEO CD with PBC functions

See page 51.

Note on VIDEO CDs

This player conforms to Ver. 1.1 and Ver. 2.0 of VIDEO CD standards. You can enjoy two kinds of playback according to the disc type.

Disc type	You can
VIDEO CD without PBC functions (Ver. 1.1)	Enjoy video playback (moving pictures) as well as music.
VIDEO CDs with PBC functions (Ver. 2.0)	Play interactive software using menu screens displayed on the TV screen (PBC Playback), in addition to the video playback functions of Ver 1.1 discs. Moreover, you can play high-resolution still pictures.

Playing a VIDEO CD/Audio CD

ON/STANDBY
 ≡ OPEN/CLOSE

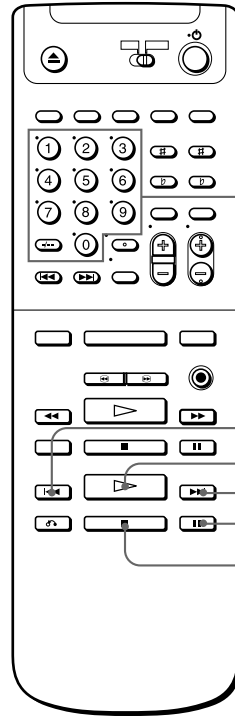
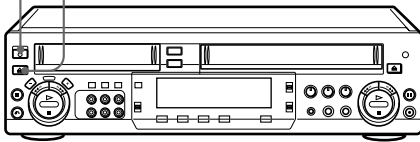



number buttons

⏮ PREV
 ▷ PLAY
 ⏭ NEXT
 ⏸ PAUSE
 ■ STOP

- 1** Turn on your TV and set it to the video channel.
 When using an amplifier, turn on the amplifier and select this player position.

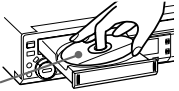
- 2**  Press ON/STANDBY to turn on the player.

- 3**  Press ≡ OPEN/CLOSE, and place the disc on the disc tray.
 with the label side up 

- 4**  Press ▷ PLAY.
 The disc tray closes and the player plays all the tracks once (Continuous Play).

Additional tasks

To	Press
Stop play	■ STOP
Pause play	PAUSE
Resume play after pause	PAUSE or ▷ PLAY
Go to the next track or scene*	▶▶ NEXT
Go back to the preceding track or scene*	◀◀ PREV
Locate a specific track	▶▶ NEXT or ◀◀ PREV, number button of the track
Locate a specific part of a track or scene	and hold ▶▶ or ◀◀ down, or 🔍 (Locked search)
Stop play and remove the CD	⊞ OPEN/CLOSE

* VIDEO CDs with PBC functions (Ver 2.0) only

Sound effect

You can use the surround sound effect. To activate the surround function, set the SOUND EFFECTOR switch to NORMAL.

To give a monaural source the effect of a stereo sound, set the SOUND EFFECTOR switch to STEREO. The STEREO function also works for monaural sound from LINE INPUT.

To cancel the surround sound effect

Set the SOUND EFFECTOR switch to OFF.

Tips

- When “RESUME” appears in the display window, you can resume playback from the point where you stopped the VIDEO CD.
- Automatic pause function works according to the signal encoded on the disc during VIDEO CD playback. If the player doesn’t resume play for a long time, press ||| or ▷ to resume play manually.
- A track is a section of a picture or a music piece on a disc. Each track is assigned track number to enable you to locate the track you want.
- To change the output signal to LINE OUT to the VCD signal manually, press OUTPUT SELECT VCD.

Notes

- When playing a VIDEO CD with PBC functions, in Step 4, the menu screen appears on the TV screen. You can play the VIDEO CD interactively, following the instructions on the menu screen.
- You need to press the OUTPUT SELECT VCD button to select the VCD part before playing when OUTPUT SEL is set to NORMAL under SET UP MENU in the menu system.

continued

Turning on this player and TV, and starting playback automatically (Trinitron TV Synchro Play)

You can only use this function if your TV is made by Sony (Trinitron TV).

How to connect to use this function

Connect this player and TV with the audio/video cable (see “Connecting” on page 6.) Be sure to connect the audio/video cable to the VIDEO IN 1 jacks on the TV if the TV has two inputs or more. The TV must be placed where it will respond to the remote commander while you are pointing it at this player.

Operation

Make sure that the TV's power is in standby mode.

Press TRINITRON TV SYNCHRO PLAY VCD and hold the remote commander in place for about two seconds.

This player and TV turn on, and the TV is set to VCR reception. If there is a disc in this player, playback starts automatically.

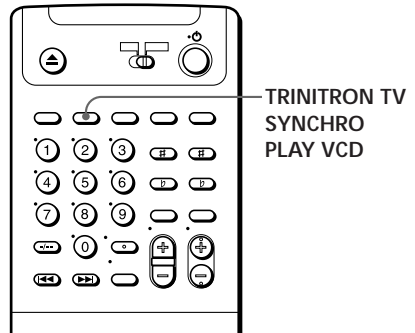

Notes

- If the Trinitron TV Synchro Play function does not work properly:
 - Wait a few moments, and press the button again.
 - Replace both of the batteries with new ones, and press the button again.Note that this function may not operate some Sony TVs because of the remote commander's signal limitations.
- Do not press TRINITRON TV SYNCHRO PLAY VCD while playing back a VCD or audio CD. If you do so, the TV's input source will momentarily switch to the TV's tuner.

Using the display window

You can check information about the disc using the display window.

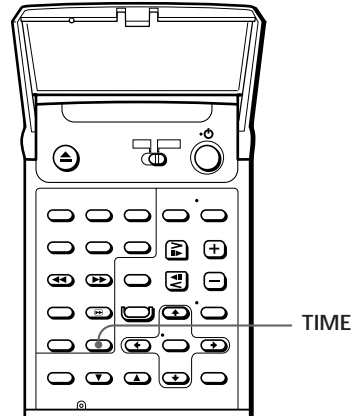

Checking the total number and playing time of the tracks

Press TIME before you start playing.

The information also appears when you press OPEN/CLOSE to close the disc tray.

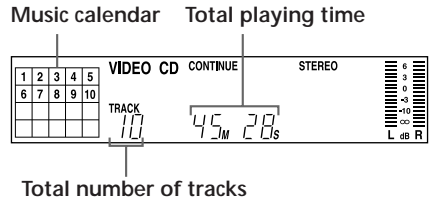

Display information while playing a disc

While playing an audio CD or a VIDEO CD with PBC functions, the display window shows following items.

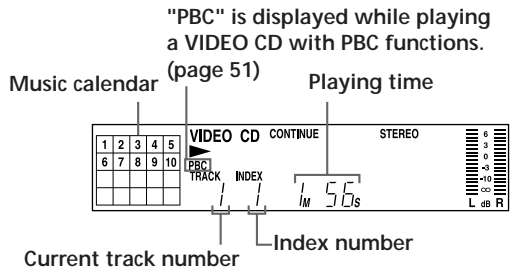

continued

Using the display window (continued)

The track numbers in the music calendar disappear after they are played.

While playing a VIDEO CD with PBC functions, the track numbers and the music calendar aren't displayed. However, while the menu screen is displayed on the TV screen, the item numbers you can select in the menu appear in the music calendar.

Note that you cannot select some item numbers even if they appear in the music calendar.

Checking the remaining time

Each time you press TIME while playing a disc, the display changes as shown in the chart below.

Note that you cannot check the remaining time during PBC Playback (page 51).

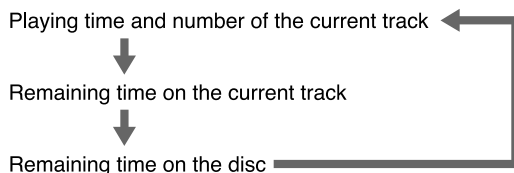

Note

- Remaining time on the disc does not appear in Program Play mode if the remaining time exceeds 100 minutes.

When using the on-screen display

You can check the operating status of the player and the information about a VIDEO CD and an audio CD with the on-screen display on the TV screen.

Press DISPLAY.

Each time you press the button, the on-screen display changes as follows:

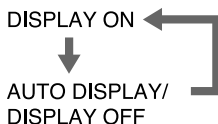

When AUTO DISPLAY is set to OFF under SET UP MENU in the menu system, the on-screen display changes between DISPLAY ON and OFF each time you press DISPLAY.

Display information of DISPLAY OFF mode

No information is displayed.

Notes

- Select the display mode other than DISPLAY OFF for normal operation. When you select DISPLAY OFF, you cannot check the operating status while operating the player. In this case, check the information in the display window.
- When you record the playback picture of this player on another VCR, etc., be sure to select DISPLAY OFF. Otherwise, the display information is also recorded on this player.

Before you start karaoke

You can sing along with a karaoke source (video tape, VCD, audio CD), a TV broadcast, or music played back on equipment connected to the LINE-1 IN jacks at the rear panel of the player. You can sing duets if you use an extra microphone (not supplied).

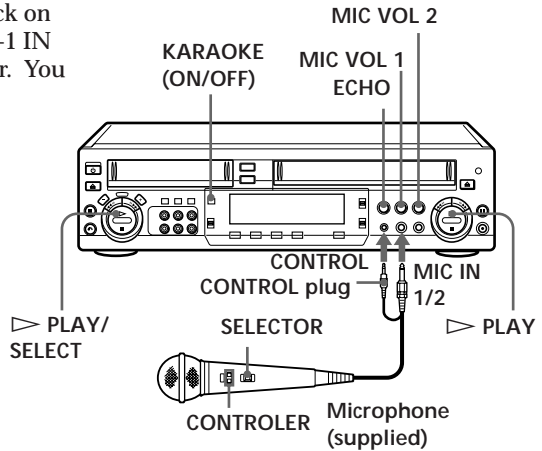

1

Turn on your TV and set it to the video channel.

When using an amplifier, turn on the amplifier and select this player position.

2

Connect the supplied microphone to the MIC IN 1 jack and its control plug to the CONTROL jack. To sing duets, connect another microphone (not supplied) to the MIC IN 2 jack.

Note

- When you select TV in CONNECT L1 under SET UP VHS (page 35) and the VHS player is in stop mode, the sound from the microphone may not go out. To hear the sound in stop mode, press INPUT SELECT 2.

Karaoke sing-along

Singing along with karaoke video tapes

- 1 Press KARAOKE (ON/OFF).
KARAOKE (ON/OFF) button lights up. "KEY 0" appears in the display window, and "KARAOKE MODE WELCOME TO THE Sony KARAOKE WORLD" appears on the TV screen.
- 2 Insert a karaoke video tape.
The player turns on and starts playing automatically if you insert a tape with its safety tab removed.
- 3 Press ▷ PLAY of the VHS part.
If you want to playback a specific song, see "Searching with the index function" on page 33.
- 4 Set the SELECTOR on the microphone to KEY or S.D.
Now you can enjoy playing karaoke.

Singing along with karaoke VIDEO CD

- 1 Press ON/STANDBY to turn on the player.
- 2 Press KARAOKE (ON/OFF).
KARAOKE (ON/OFF) button lights up. "KEY 0" appears in the display window, and "KARAOKE MODE WELCOME TO THE Sony KARAOKE WORLD" appears on the TV screen.
- 3 Press ≡ OPEN/CLOSE, and place the disc on the disc tray.
- 4 Press ▷ PLAY of the VCD part.
The disc tray closes and starts. If you want to playback a specific song, see "Playing a VIDEO CD/Audio CD" on page 16.
- 5 Set the SELECTOR on the microphone to KEY or S.D.
Now you can enjoy playing karaoke.

To adjust the microphone volume

Turn the MIC VOL 1 control for the microphone connected to MIC IN 1.

Turn the MIC VOL 2 control for the microphone connected to MIC IN 2.

Setting the MIC VOL 1 and/or 2 control(s) to the centre position provides the best microphone volume.

To control the echo effect

Turn the ECHO control. This controls both microphones' echo effect in the same way.

To get the best effect, adjust the microphone volume to a level slightly higher than the music volume.

continued

Karaoke sing-along (continued)

Sound effect

You can use the surround sound effect. To activate the surround function, set the SOUND EFFECTOR switch to NORMAL.

To give a monaural source the effect of a stereo sound, set the SOUND EFFECTOR switch to STEREO. The STEREO function also works for monaural sound from LINE INPUT.

To cancel the surround sound effect

Set the SOUND EFFECTOR switch to OFF.

Tip

- When you sing along with TV broadcasts or music played back on equipment connected to the LINE-1 IN jacks on this player, play the music source and, then press KARAOKE and set the SELECTOR on the microphone to KEY or S.D.

Notes

- If the sound is reproduced through a stereo amplifier, turn down the volume of amplifier before operation.
- If streaks appear during playback, select the colour system that the tape was recorded in (see "To set the colour system" on page 12).
- If feedback occurs, turn down the microphone or TV volume, or move the microphone away from the speakers.

Using the supplied microphone

CHOI button

Monitor the picture in reverse while pressing this button.

SELECTOR switch

When you want to use the Key Control function or Self Duet function, select KEY or S.D (page 57, 58).

CONTROLLER buttons

When you select KEY, change the pitch from # 8 to ♭ 8 using these buttons. To return to the original pitch, press KEY CONTROL ♭ or # until "0" appears in the display window (page 57).

When you select S.D., press # for S.D.#, ♭ for S.D.♭. To cancel Self Duet, press the same button again (page 58).

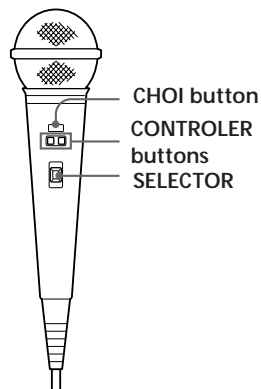

Displaying the karaoke information

Press DISPLAY when the KARAOKE (ON/OFF) switch is set to ON. The karaoke information appears on the TV screen. If you press DISPLAY once more, the remaining tape length and tape counter will also appear.

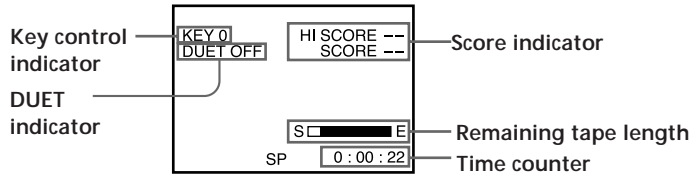
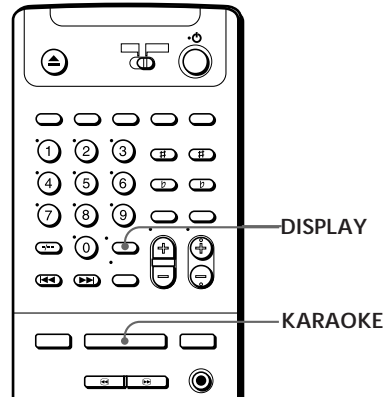
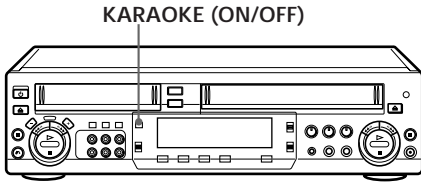

Playing/searching at various speeds

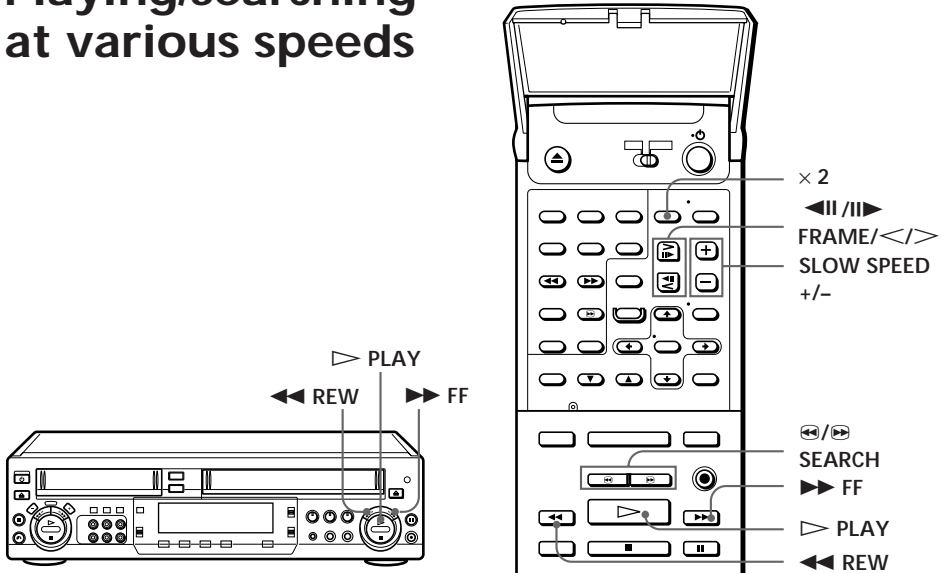

Playback options	Operation
Fast-forward/rewind	During stop, press ►► FF or ◄◄ REW.
View the picture during fast-forward or rewind	During fast-forward, hold ►► FF down. During rewind, hold ◄◄ REW down.
Play at twice the normal speed	During playback, press × 2.
Play at high speed	During playback or pause, press ► SEARCH or ◄ SEARCH. To change direction, press > or <.
Play in slow motion	During playback or pause, press SLOW SPEED +/- . Press the +/ - buttons to change the speed. To change direction, press > or <.
Play frame by frame	During pause, press ► FRAME or ◄ FRAME. Hold the button down to play one frame each second.
Play in reverse	During playback, press <.
Rewind and start play	During stop, hold ◄◄ REW <u>on the player</u> down and press ► PLAY <u>on the player</u> .

To resume normal playback

Press ▷ PLAY.

Tip

- Adjust the picture using TRACKING AUTO/MAN and ▼/▲ TRACKING NORMAL/SLOW STILL ADJUST (page 34) if:
 - streaks appear while playing in slow motion
 - bands appear at the top or bottom while pausing
 - the picture shakes while pausing.

Note

- In LP mode, noise may appear or there may be no colour.

Recording TV programmes

When your TV is equipped with audio/video output jacks, you can record a programme showing on the TV.

Before you start

- Connect the LINE-1 IN jacks of the player to the audio/video output jacks of your TV.
- Make sure that CONNECT L1 on the menu option is set to TV.

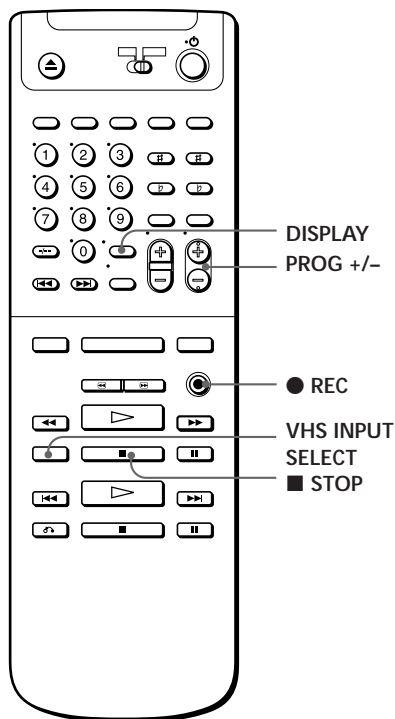
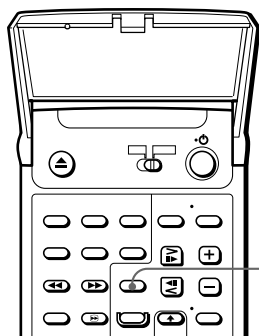

- 1 Turn on your TV and set it to the video channel.
- 2 Press INPUT SELECT 1 (or press VHS INPUT SELECT on the remote repeatedly until "LINE1" appears).
INPUT SELECT 1 button lights up.
- 3 Insert a tape with its safety tab in place into the VHS part of this player.
- 4 Press TAPE SPEED to select the tape speed, SP or LP.
LP provides recording time twice as long as SP; however, SP produces better picture and audio quality.



- 5 Press ● REC to start recording.
During recording, do not change the TV channel or turn off the TV.
When the tape reaches the end, the unit automatically rewinds it to the beginning.

To stop recording

Press ■ STOP.

To check the remaining tape length

Press DISPLAY during playback or recording. The white bar indicates the approximate length of tape remaining.

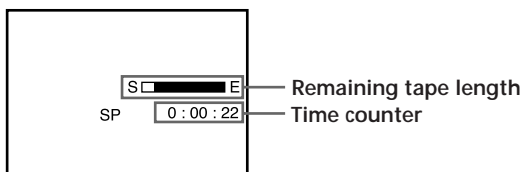

To save a recording

To prevent accidental erasure, break off the safety tab as illustrated. To record on the tape again, cover the tab hole with adhesive tape.



To record NTSC colour system programmes

NTSC colour signals input through the LINE-1 IN jacks can be recorded on this player.

For tape speed, select SP or EP in step 4.

EP provides recording time three times as long as SP; however, SP produces better picture quality.

When playing back, the player automatically detects the tape speed.

Tips

- You can select a video source from the LINE-1 IN jacks using VHS INPUT SELECT.
- The display appears on the TV screen indicating information about the tape, but the information won't be recorded on the tape.

Notes

- The display appears only during playback at normal speed.
- The white bar (remaining tape length) will not appear while playing an NTSC-recorded tape.
- If you've inserted a tape with its safety tab removed, the player ejects it when you press ● REC.
- When the CONNECT L1 option in SET UP VHS is set to TV (page 35) and you play a VIDEO CD or an audio CD, the TV sound is not recorded on the normal track.

Editing with another VCR

How to connect to record on the VHS part of this player

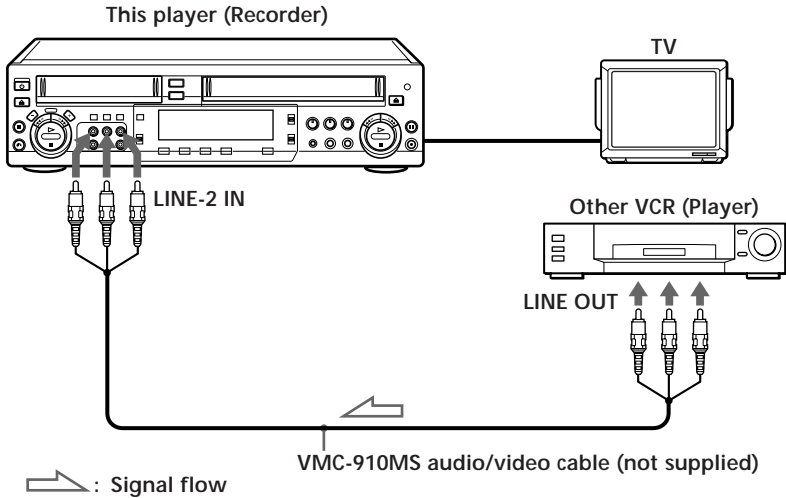

Notes

- Make sure you connect the plugs to jacks of the same colour.
- If the other VCR is a monaural type, leave the red plugs unconnected.
- When connecting, do not simultaneously connect the LINE-2 IN and LINE OUT jacks on this player. A humming noise may occur if you do this.

Operation (when recording on the VHS part of this player)

|| PAUSE

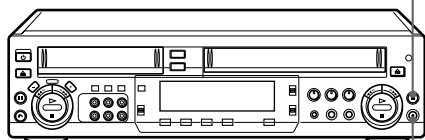

● REC

Before you start editing

- Turn on your TV and set it to the video channel.
- Press INPUT SELECT 2 to light up the button (or press INPUT SELECT on the remote until “LINE 2” appears).
- Press TAPE SPEED to select the tape speed (SP or LP for the PAL system, and SP or EP for the NTSC system).

- 1 Insert a source tape with its safety tab removed into the other (playback) VCR. Search for the point to start playback and set it to playback pause.
- 2 Insert a tape with its safety tab in place into this (recording) VHS part of this player. Search for the point to start recording and press || PAUSE.
- 3 Press ● REC on this VHS part of this player and set it to recording pause.
- 4 To start editing, press the || PAUSE buttons on the VCR and this VHS part at the same time.

To stop editing

Press the ■ STOP buttons on the VCR and this VHS part.

Tips

- To edit more precisely, press the || PAUSE buttons on the VCR and this VHS part to release pause.
- To cut out unwanted scenes while editing, press || PAUSE on this VHS part when an unwanted scene begins. When it ends, press || PAUSE again to resume recording (Assemble Editing).

Note

- If you start recording following the procedure above, the VHS part of this player won't start recording with the APC function. To record a tape with the APC function, press ● REC again during recording pause in step 3 so that this player analyses the tape. Then when you start recording in step 4, press || PAUSE after the APC indicator stops flashing. If you press || PAUSE before the APC indicator stops flashing, the APC function is cancelled.

continued

Editing with another VCR (continued)

Recording stereo programmes

The VHS part of this player can record stereo and bilingual programmes only through the line input. When stereo or bilingual sound is input through the LINE IN jacks, the STEREO indicator lights up. You cannot select the sound to listen to while recording.

Selecting the sound during playback

Press AUDIO MONITOR to select the sound you want.

To listen to	On-screen display	Display window
Stereo/main and sub (left and right channels)	STEREO	“STEREO” lights up
Left channel/main	LCH	“L” under the sound indicator lights up
Right channel/sub	RCH	“R” under the sound indicator lights up
Standard sound*	No indication	No indication

* The mixed sound of left and right channels (monaural)

How sound is recorded on a video tape

The VHS part of this player records sound onto two separate tracks. Hi-fi audio is recorded onto the main track along with the picture. Monaural sound is recorded onto the normal audio track along the edge of the tape.

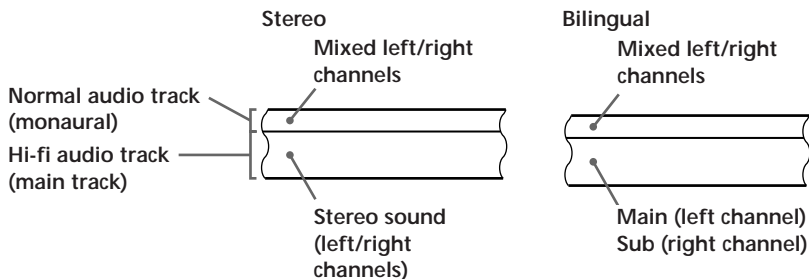

Notes

- To listen to playback sound in stereo, you must use the AUDIO OUT connections.
- When you play a tape recorded in monaural, the sound is heard in monaural regardless of the AUDIO MONITOR setting.
- If the AUDIO MONITOR button does not function, check that AUDIO MIX under SET UP VHS is set to OFF (page 35).

Searching with the index function

You can search for the start of a specific passage or scene (Index search).

The VHS part of this player can search up to 99 index signals ahead or behind the current position.

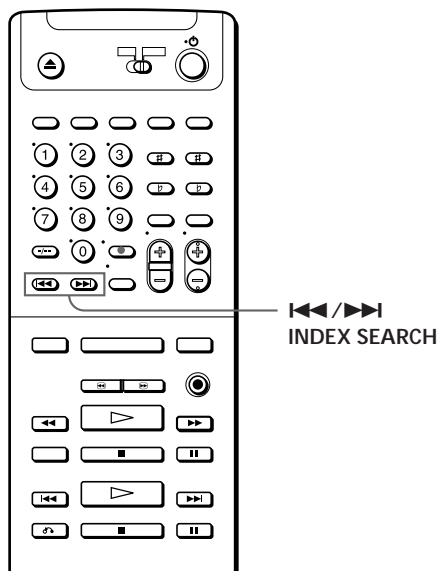

- 1 Insert an indexed tape into the VHS part of this player.
- 2 Press **◀◀/▶▶** INDEX SEARCH repeatedly to specify how many index signals ahead or behind you want to search:

- To search forward, press **▶▶** INDEX SEARCH.
- To search backward, press **◀◀** INDEX SEARCH.

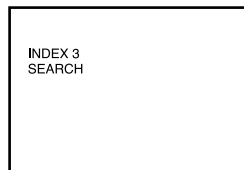

This player starts searching. The specified number of index signals is displayed on the TV screen, and it counts down to zero. At the end of the search, playback starts automatically.

To stop searching

Press **■** STOP.



Note

- No index signal will be added when recording starts from recording pause.

Adjusting the picture

Adjusting the tracking

Although the VHS part of this player automatically adjusts the tracking when playing a tape (the tracking indicator  flashes in the display window, then goes off), distortion may occur if the tape was recorded in poor condition. If so, manually adjust the tracking.

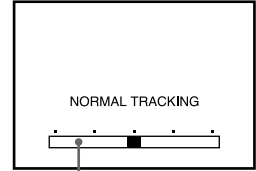

- 1 Press TRACKING AUTO/MAN to change to manual adjustment.
- 2 Press / TRACKING NORMAL/SLOW STILL/ ADJUST to display the tracking meter. The distortion should disappear as you press one of the two buttons. (The  indicator lights up.)



If you cannot get a clear picture with manual adjustment, press TRACKING AUTO/MAN to return to automatic adjustment.

About Adaptive Picture Control (APC)

Adaptive Picture Control (APC) automatically improves recording and playback quality by adjusting this player to the condition of the video heads and tape. To maintain better picture quality, we recommend that you set APC to ON under SET UP VHS (with the APC indicator in the display window lit).

SET UP VHS			
AUDIO MIX	ON	•OFF	
▶APC	•ON	OFF	
RESERVE MODE	•AMS	INDEX	
CONNECT L1	•TV	OTHER	
SELECT	:	[]	
SET	:	[]	

APC playback

The APC function automatically works on all types of tapes, including rental tapes and tapes that were not recorded with APC.



APC recording

Whenever you insert a tape and first start recording, the VHS part of this player adjusts to the tape using the APC function (the APC indicator flashes rapidly). This adjustment is retained until the tape is ejected.

To deactivate the APC

Press MENU and select SET UP VHS, then set APC to OFF. The APC indicator in the display window goes off.

Note

- There is a delay of a few seconds before this player actually starts recording while the player analyzes the tape. To avoid the delay, first set this player to recording pause (the APC indicator flashes slowly) and press  REC to have this player analyze the tape (the APC indicator flashes rapidly). After the APC indicator stops flashing, press  PAUSE to start recording immediately. If you want to start recording quickly without using the APC function, first set this player to recording pause (the APC indicator flashes slowly) and press  PAUSE to start recording.

Changing menu options

1 Press MENU and select SET UP VHS.

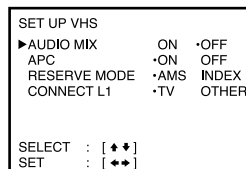

2 Press CURSOR \uparrow/\downarrow to select the option to change, then press CURSOR \leftarrow/\rightarrow to change the setting.

3 Press EXE to return to the original screen.

Menu choices

Initial settings are indicated in bold print.

Menu option	Set this option to
AUDIO MIX	<ul style="list-style-type: none">• ON to listen to the hi-fi and normal audio tracks at the same time. The AUDIO MONITOR button will not function.• OFF to listen to hi-fi and normal audio tracks separately. Select the sound using the AUDIO MONITOR button.
APC	<ul style="list-style-type: none">• ON to switch on the APC (Adaptive Picture Control) function and improve picture quality.• OFF to switch off APC.
RESERVE MODE	<ul style="list-style-type: none">• AMS for automatic music search of blank spaces in the sound track.• INDEX for index function search of index signal.
CONNECT L1	<ul style="list-style-type: none">• TV to record TV programmes using the LINE-1 IN jacks.• OTHER to record other audio/video sources using the LINE-1 IN jacks.

Notes

- AMS locates only the blank spaces of more than about 8 seconds.
- INDEX works only when the blank space is more than about 4 seconds long and an index signal is recorded.
- The settings in the menu return to initial settings when you disconnect the mains lead.
- When you select TV in CONNECT L1,
 - the picture and sound signal from LINE-1 IN do not go out to LINE OUT
 - the picture signal from LINE-1 IN does not go out to AERIAL OUT.

Audio dubbing

This feature lets you record over the normal audio track. The monaural sound previously recorded is replaced while the original hi-fi sound remains unchanged. You can also record your karaoke performances.

Audio dubbing from a stereo system or other external source

Before you start...

- Turn on your TV and set it to the video channel.
- Press VHS INPUT SELECT to display "L1" in the display window.

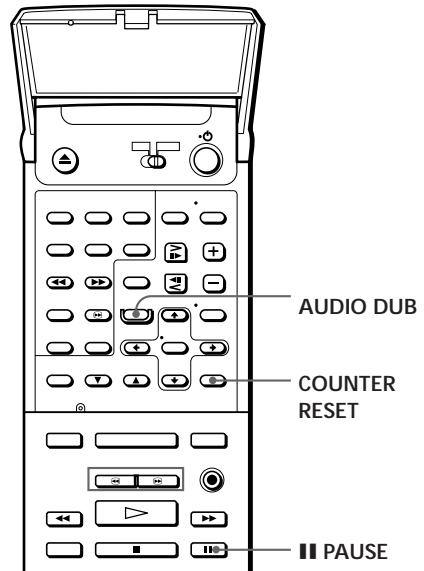

- 1 Insert a source tape into the stereo system (or the playback VCR). Search for the point to start playback, and set that equipment to playback pause.
- 2 Insert a prerecorded tape into this (recording) player. Search for the end of the section to be replaced and press **|| PAUSE**.
Make sure that the tape has its safety tab in place.
- 3 Press COUNTER RESET to reset the counter to "0H00M00S."
- 4 Search for the beginning of the section to be replaced and press **|| PAUSE**.
- 5 Press AUDIO DUB.
The audio dubbing indicator \ominus appears in the display window.
- 6 To start editing, press the **|| PAUSE** buttons on this player and the stereo system (or other VCR) at the same time.
When the counter reaches "0H00M00S," audio dubbing stops automatically.

To stop while recording

Press the **■ STOP** buttons on this player and the stereo system (or other VCR).

To listen to both the hi-fi and normal audio

Set AUDIO MIX to ON under SET UP VHS in the menu system (page 35).

Use this feature to listen to dubbed audio over the original hi-fi audio.

When AUDIO MIX is set to ON, the AUDIO MONITOR button does not function. Remember to reset AUDIO MIX to OFF after playing the tape.

Audio dubbing from the microphone

Using the microphone, you can add songs or narration on a recorded tape during playback of the tape. Sound from the microphone is recorded on the normal audio track together with the left sound and right sound of the original hi-fi sound.

Before you start...

- Connect the microphone(s) to the MIC IN 1 and/or 2 jack(s), and its control plug to the CONTROL jack. And then the SELECTOR on the microphone to KEY or S.D.

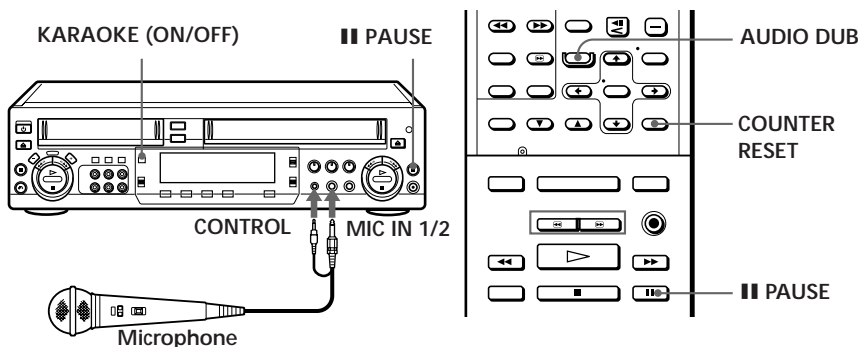

- 1 Set KARAOKE (ON/OFF) to ON.
- 2 Insert the prerecorded tape into the VHS part of this player. Search for the end of the section to be replaced and press || PAUSE.
Make sure that the tape has its safety tab in place.
- 3 Press COUNTER RESET to reset the counter to "0H00M00S."
- 4 Search for the beginning of the section to be replaced and press || PAUSE.
- 5 Press AUDIO DUB.
The audio dubbing indicator ⊖ appears in the display window.
- 6 To start editing, press || PAUSE to start dubbing and sing or speak into the microphone.
When the counter reaches "0H00M00S," audio dubbing stops automatically.

continued

Audio dubbing (continued)

To stop while recording

Press ■ STOP.

To listen to the dubbed sound

When playing an audio-dubbed tape, you have a choice of sound to listen to. For the dubbed sound, select standard sound with the AUDIO MONITOR button (page 32).

To record sound from the microphone mixed with an external source

If you connect equipment such as a laser disc player to this VCR's LINE-1 IN jacks, you can record while singing along to a karaoke LD. Be sure to press VHS INPUT SELECT to display "L1" before starting recording. The mixed sound is recorded on the normal audio track, and the sound input from the LINE-1 IN jacks is recorded on the hi-fi audio track.

Tip

- When dubbing from the microphone, you can use the functions of echo effect, key control, and Self Duet.

Notes

- Do not dub on a tape recorded in LP mode. Audio noise may occur.
- Recording stops if you press the COUNTER RESET button while audio dubbing.

Locating scenes directly using the scene numbers (Scene Search)

On a VIDEO CD with PBC functions, the menu screens, moving pictures and still pictures are divided into “scenes” and each scene is assigned with a scene number.

You can check the current scene number by displaying it on the TV screen during playback (page 20). Be sure to memorize the scene number from which you want to start playing.

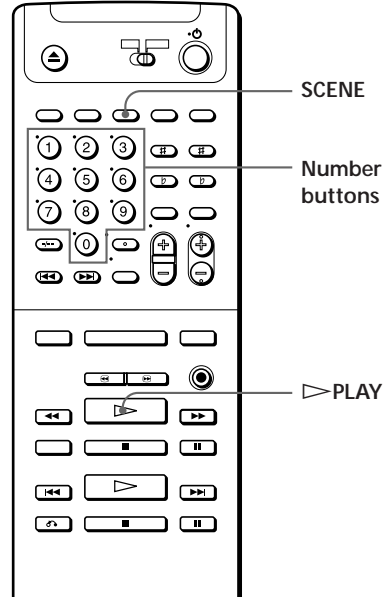

- 1 Press SCENE before you start playing or while playing a disc. “SCENE -” and the scene numbers appear on the TV screen.

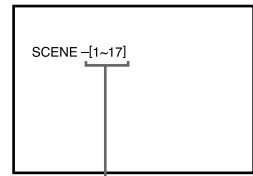

Total scene numbers

- 2 Press the number buttons (0 - 9) to select the scene. The selected scene number appears on the TV screen.

If you've made a mistake, press the correct number button again.

When you change a number under 10, press 0 and then the correct number.

Example: To change 2 to 5, press 0, then 5.

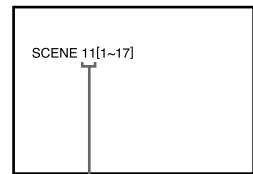

Selected scene number

continued

Locating scenes directly using the scene numbers (Scene Search) (continued)

- 3** Press \triangleright to start playing from the selected scene.
The player automatically starts PBC Playback.

To check the scene number while playing a disc

Press DISPLAY (page 20). The scene numbers appear on the upper left side of the TV screen.

Notes

- Some discs don't allow you to start playing from a particular scene. In this case, when you do the task before you start playing, the player starts playing from scene 1. When you do the task while playing a disc, the player starts playing from the current scene.
- Some discs don't display the selected scene on the TV screen.

Resuming playback from the point you stopped a VIDEO CD (Resume Play)

The VCD part of this player memorizes the point you stopped a VIDEO CD and you can resume playback from that point.

Resume Play is not cancelled whenever you turn off the VCD part of this player.

Note that Resume Play is not available while playing an audio CD.

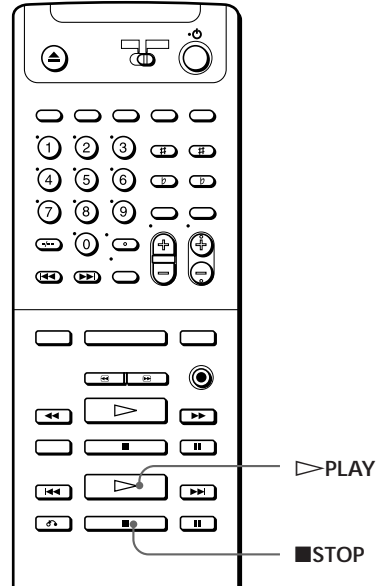

- 1 While playing a VIDEO CD, press ■ to stop playback.
"RESUME" appears in the front panel display and on the TV screen.
If "RESUME" doesn't appear, Resume Play is not available.

- 2 Press ▷.
The player starts playback from the point you stopped the VIDEO CD in Step 1.

To view from the beginning of the VIDEO CD

When "RESUME" appears in the front panel display, press ■, then press ▷.

Notes

- Resume Play is not available in Shuffle or Program Play mode.
- Depending on where you stopped the VIDEO CD, the player may resume playback from a different point.
- The point at which you stopped playing is cleared when :
 - you press number buttons or ■
 - you remove the VIDEO CD from the player
 - you unplug the AC power cord of the player

Locating a particular point in a scene or track

You can also locate a particular point in a scene or track while playing a disc.

During PBC Playback (page 51), this function is available only while playing moving pictures.

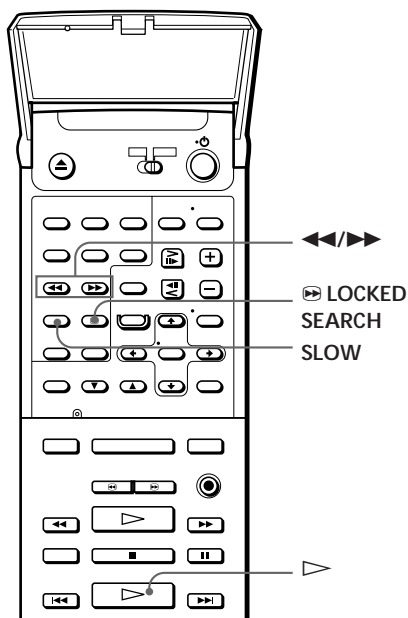

To locate a point	Press
While monitoring the picture or sound	▶▶, or ▶▶ (forward) / ◀◀ (backward) and hold down until you find the point. You will not hear the sound while playing a VIDEO CD.
Slowly by observing the TV screen (Slow-motion Play*)	SLOW. You will not hear the sound during the operation. When you find the point, press ▷ to return to the normal speed.
Quickly by observing the display window during pause	◀◀/▶▶ and hold down until you find the point. You will not hear the sound during the operation.

* While playing an audio CD, Slow-motion Play is not available.

If "⏮" appears in the display window

The disc has reached the end while you were pressing ▶▶. Press ◀◀ or ⏮ to go back.

If you want to change the playback speed during Slow-motion Play

Press SLOW repeatedly until you find the playback speed you want. Three speeds are available: SLOW 1 (1/5th the normal speed), SLOW 2 (1/10th) and SLOW 3 (1/15th).

Note

- While playing a VIDEO CD, the picture may be distorted during the search operation.

Locating a point using the index (Index Search)

There are two kinds of indexes: one is for audio CDs and the other is for VIDEO CDs. You can locate a point you want using the index.

Note that this function is available only for indexed discs. Also note that you cannot search indexes in different tracks.

- 1 Press INDEX SEARCH while playing a disc.
"INDEX -" appear on the TV screen.

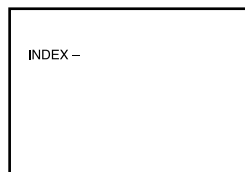

- 2 Press the number buttons (0 - 9) to select the index number.
The selected index number appears on the TV screen.

Display window

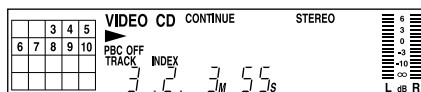

Selected index number

If you've made a mistake, press the correct number button again.

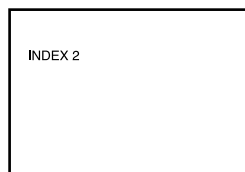

- 3 Press \blacktriangleright to start playing from the selected index.
The player automatically starts playback.

continued

Locating a particular point in a scene or track (continued)

Tip

- Index is a number that divides a track or a disc into some sections in order to easily locate the point you want. You may determine if a disc uses index by looking at the disc's packaging.

Notes

- If there is no index, "THERE IS NO INDEX" appears on the TV screen.
- If the index which you select is not recorded, "THIS NUMBER DOES NOT EXIST" appears on the TV screen.

Playing repeatedly

You can play all the tracks, a single track or a specific portion repeatedly.

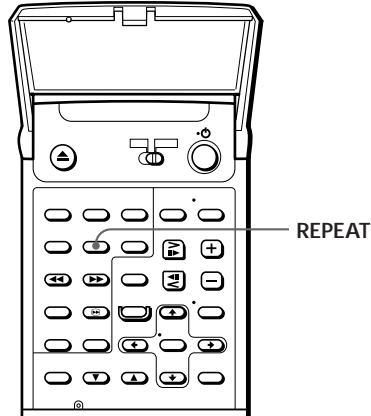

Repeating all the tracks on a disc

In Shuffle or Program Play mode, the player repeats the track in the shuffled or programmed order. You cannot do Repeat Play during PBC playback (page 51) .

Press REPEAT while playing a disc.

“↺” appears in the display window. The player repeats the tracks as follows:

When the disc is played in	The player repeats
Continuous Play (page 17)	All the tracks
Shuffle Play (page 47)	All the tracks in random order
Programme Play (page 48)	The same program

To cancel Repeat Play

Press REPEAT repeatedly until “↺” disappears from the display window.

continued

Playing repeatedly (continued)

Repeating the current track

You can repeat only the current track in Continuous Play mode (page 17).

While the track you want is being played, press REPEAT repeatedly until “↶ 1” appears in the display window.



To cancel repeating the current track

Press REPEAT repeatedly until “↶ 1” disappears from the display window.

Playing in random order (Shuffle Play)

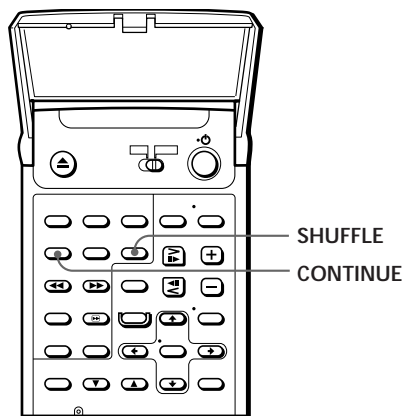
You can have the player “shuffle” tracks and play in a random order.



- 1 Press SHUFFLE.
“SHUFFLE” appears in the display window.
- 2 Press  to start Shuffle Play.
The  indication appears while the player is “shuffling” the tracks.

To cancel Shuffle Play

Press CONTINUE.

“CONTINUE” appears in the display window.

To start Shuffle Play while playing in Continuous Play mode

Press SHUFFLE.

Shuffle Play starts from the current track.

Note

- If you play a VIDEO CD with PBC functions in Shuffle Play mode, you cannot use the PBC functions.

Creating your own programme (Programme Play)

You can arrange the order of the tracks on the discs and create your own programme. The programme can contain up to 24 tracks.

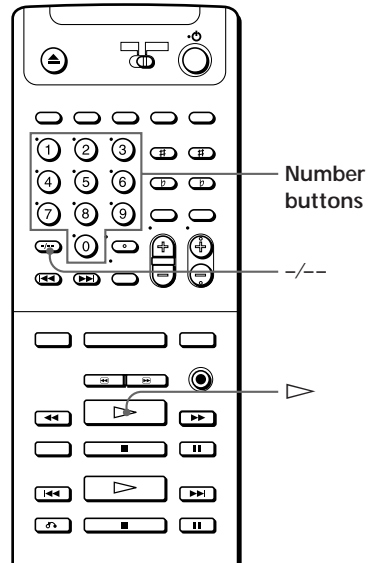
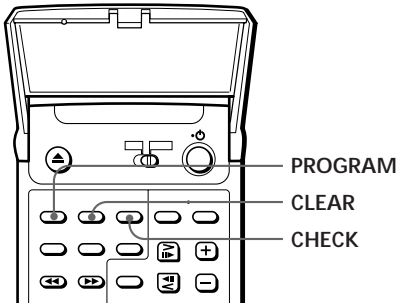

- 1 Press PROGRAM.
"PROGRAM" appears in the display window.

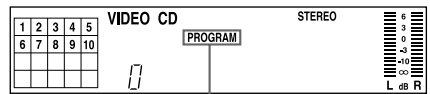

"PROGRAM" is lit

- 2 Press the number buttons of the tracks you want to programme in the order you want.
To programme a track numbered over 10, use the -/-- button.

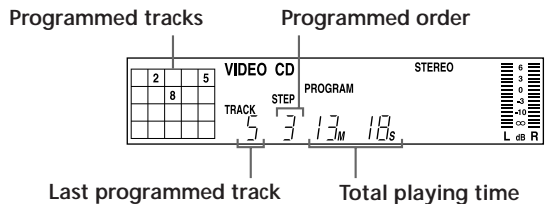

If you've made a mistake, press CLEAR, then press the correct number button.

3 Press ▷ to start Programme Play.

To cancel Programme Play

Press CONTINUE.

“CONTINUE” appears in the display window.

To programme while checking the total playing time instead of step 2 (Programme Edit)

- 1** Press ◀◀ or ▶▶ until the track you want to programme appears in the display window.
The total playing time including the selected track appears in the display window.
- 2** Press PROGRAM to confirm your selection.
- 3** Repeat steps 1 and 2 to programme more tracks.

To insert a pause as one step

During programming, press ■■ to insert a pause. The total playing time is reset to “0.00.”

When playing a programme which contains a pause, the player pauses at the step in which a pause is programmed, until you press ■■ or ▷. This might be useful when you record a programme on both sides of a tape.

Tip

- The programme remains even after the Programme Play ends.
When you press ▷, you can play the same programme again.

Notes

- If you play a VIDEO CD with PBC functions in Programme Play mode, you cannot use PBC functions (page 51).
- If the total playing time exceeds 100 minutes, “- - . - -” appears in the display window.
- If you programme more than 24 tracks, “FULL” appears on the TV screen.

continued

Creating your own program (Program Play) (continued)

Checking the track order

Press CHECK before or after you start playing.

Each time you press this button, the display window shows the track number and the total playing time in the programmed order. After the last track in the programme, the display window shows “End” and returns to the original display. If you check the order after you start playing, the display window shows only the remaining track numbers and playing time.

Changing the track order

You can change your programme before you start playing.

To	Press
Erase a track	CHECK until the track you don't want appears in the display, then press CLEAR.
Erase the last track in the programme	CLEAR. Each time you press this button, the last track is cleared.
Add tracks to the end of the programme	Number buttons of the tracks to be added.
Change the whole programme completely	■ (stop). Create a new programme.

Tip

- You can check the contents of the programme during programming on the TV screen.
If you press DISPLAY to select DISPLAY OFF mode, you won't see this information (page 21).

Playing a VIDEO CD with PBC functions (PBC Playback) (continued)

- 2 Select the item number you want.
 - On the player:
Press MENU + or - to select the item number, then press \triangleright (SELECT).
 - On the remote:
Press the number button of the item you want.
When you want to select an item number over 10, press -/-- first, then the corresponding number buttons.
- 3 Follow the instructions on the menu screen for interactive operations.

To	Press (on the remote)
Stop play	■ STOP
Select the item (while the MENU indicator is flashing)	number buttons on the remote or MENU -/+ , then \triangleright (SELECT)
Go back to the menu screen	\curvearrowright PBC RETURN , \lll PREV, or \ggg NEXT.

To cancel PBC Playback of a VIDEO CD with PBC functions and play the disc in Continuous Play mode

There are three ways.

- Press PBC ON/OFF.
- Before you start playing, select the track you want with \lll or \ggg , then press \triangleright .
- Before you start playing, select the track number using the number buttons on the remote.

“PBC OFF” appear in the display window and the player starts Continuous Play. You cannot play still pictures such as a menu screen. You cannot cancel PBC playback by pressing CONTINUE.

Note

- When “YOU CANNOT USE THIS KEY NOW” appears on the TV screen, you’ve pressed an invalid button. Press the correct button, following the instructions on the menu screen.

Switching the sound

On multiplex discs, you can select the sound from the right or left channel and listen to the sound of the selected channel through both the right and left speakers. In this case, the sound loses the stereo effect.

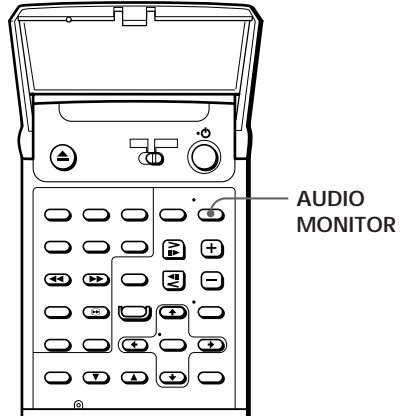

Press AUDIO MONITOR while playing a disc.

Each time you press the button, the indication and the sound from the speakers change as follows:

Press	Indication*	You will hear
Once	L ch	The sound of the left channel
Twice	R ch	The sound of the right channel
Three times	STEREO	The standard stereo sound

* When you select DISPLAY OFF mode, check the indication in the display window.

Note

- When you turn off the player, the standard stereo playback will be resumed.

Programming the order of the songs

You can programme the order of the songs. The programme can contain up to 12 songs.

- 1 Press KARAOKE (ON/OFF).
The KARAOKE (ON/OFF) button lights up.
- 2 Insert a karaoke video tape or/and press \cong OPEN/CLOSE and place the disc on the disc tray.
- 3 Press RESERVE.
The KARAOKE RESERVE menu appears on the TV screen.

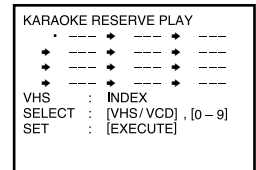

- 4 Press VCD or VHS on the remote to select karaoke source.
- 5 Press the number buttons of the songs you want to program using double digits.
Example: To select song number 5, press 0, then 5.
If you've made a mistake, press CURSOR \rightarrow \leftarrow to select the desired programme, then press correct karaoke source and number button.
- 6 Repeat steps 4 and 5 to program the order you want.
- 7 Press EXECUTE to start playing.
The video tape automatically rewinds to the beginning, and playback starts in the order you selected. While the player searches for a song, the song number flashes in the display window.

To stop playing

Press \blacksquare STOP.

To go to the next song

Press INDEX $\blacktriangleright\blacktriangleright\blacktriangleright$ or AMS $\blacktriangleright\blacktriangleright\blacktriangleright$.

To repeat the current song

Press INDEX $\blacktriangleleft\blacktriangleleft$ or AMS $\blacktriangleleft\blacktriangleleft$.

To add songs while playing

Repeat steps 3 to 5. You can enter up to 12 songs.

To select the way of searching a video tape

When you stop playing, select on the RESERVE MODE under SET UP VHS in the menu system (page 35).

Tip

- During playback in KARAOKE RESERVE mode, you can change the programmed order. To change the order, press RESERVE and repeat steps 4 and 5.

Notes

- If you press KARAOKE (ON/OFF) to turn off the button, the list settings are cleared.
- This player exits the KARAOKE RESERVE mode when you
 - press ■ STOP.
 - press KARAOKE (ON/OFF).
 - use ⏻ (on/standby).
- If you rewind past the beginning of the current song using a microphone with CHOI function, the selected song order may not be played correctly.

Using the various functions

Reducing the playback vocals (Karaoke Pon)

You can use ordinary music sources with vocals for karaoke with this function. Use hi-fi stereo music sources.

Set KARAOKE MODE to KARAOKE PON.

The singer's voice will be reduced.

To cancel Karaoke Pon

Set KARAOKE MODE to OFF.

Note

- Karaoke Pon does not work with the following sources:
 - Sources on which different vocal sounds are recorded on the left and right channels, such as a duet
 - Sources recorded monaurally
 - Sources on which sound sources are recorded with strong echo effects and chorus effects

Backing up your singing (Vocal Assist)

This player can assist your singing in case you forget the lyrics while you are singing. The player fills in the vocal for you automatically if you stop singing into the microphone.

Use karaoke stereo hi-fi sources which have the accompaniment music on the left channel and the accompaniment plus vocal on the right channel.

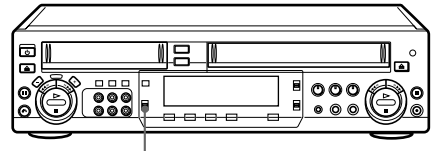

KARAOKE MODE

Set KARAOKE MODE to VOCAL ASSIST.

To cancel Vocal Assist

Set KARAOKE MODE to OFF.

Notes

- Vocal Assist does not work with the following tapes:
 - Hi-fi tapes on which a single sound is recorded on the left and right channels
 - Monaural recorded tapes
- When the disc is recorded with the singer's voice on the left channel, set CD VOCAL SEL under SET UP MENU to Lch.

Changing the pitch (Key Control)

While you are singing, you can change the pitch of the song to match your vocal range.

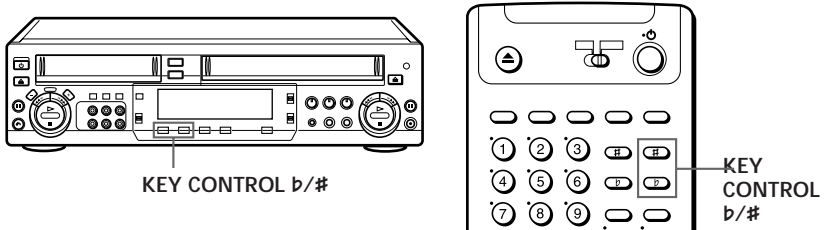

Press **KEY CONTROL b** or **#** repeatedly to set the pitch you want.

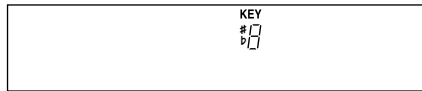

You can change the pitch of the song in half-note intervals.

The pitch you set appears in the display window.

To	Press	Range	Display window
Raise the pitch	# (sharp)	8 half notes	"#1" to "#8"
Lower the pitch	b (flat)	8 half notes	"b1" to "b8"

To return to the original pitch

Press **KEY CONTROL b** or **#** until "0" appears in the display window.

Note

- If you connect an amplifier or TV to Video CD DIRECT OUT, you cannot use key control.

continued

Using the various functions (continued)

Adding harmony (Self Duet)

You can sing duets by yourself. This player creates a harmony voice for your singing at an interval set with the key control.

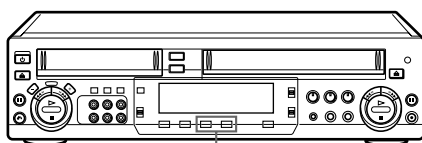

SELF DUET \flat / \sharp

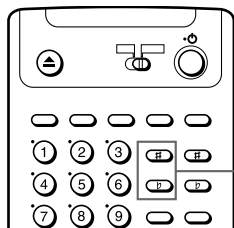

SELF DUET \flat / \sharp

Press SELF DUET \flat or \sharp to set the harmony interval.



To	Press	Display window
Raise the pitch of the harmony voice	\sharp (sharp)	"S.D. \sharp "
Lower the pitch of the harmony voice	\flat (flat)	"S.D. \flat "

To cancel Self Duet

Press SELF DUET \flat or \sharp again.

To improve Duet Effect

You can set this player to add vibrato to the harmonized voice when the duet is not in harmony. Press MENU and select SET UP MENU, then set DUET EFFECT to ON.

SET UP MENU		
SCORE LEVEL	HIGH	·LOW
▶DUET EFFECT	·ON	·OFF
AUTO SCORE	ON	·OFF
OUTPUT SEL	PB	·NORM
DIMMER	ON	·OFF
AUTO DISPLAY	·ON	OFF
CD VOCAL SEL	Lch	·Rch
SELECT	: [\blacktriangle]	
SET	: [\blacktriangle]	

Note

- If you connect an amplifier or TV to Video CD DIRECT OUT, you cannot use self duet.

Grading your singing

As an extra challenge, this player can grade your singing.

- 1 Start singing and press SCORE.

The SCORE appears on the TV screen, and this player starts analyzing your singing.

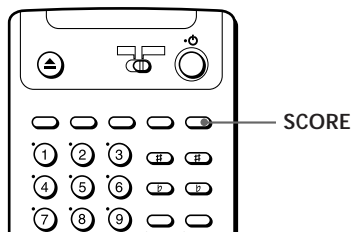

- 2 Press SCORE again after singing for more than one minute.

Your score appears on the TV screen for five seconds. The highest score (HIGH SCORE) is saved, and is indicated above your present score.

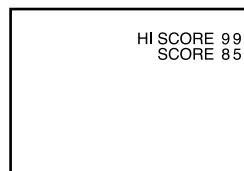

To set score level

This player has two different score levels. To set the score level, press MENU and select SET UP MENU. Then set SCORE LEVEL to HIGH for strict grading or LOW for easy grading.

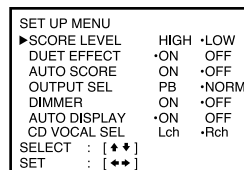

To grade singing automatically

Press MENU and select SET UP MENU.

Then set AUTO SCORE to ON.

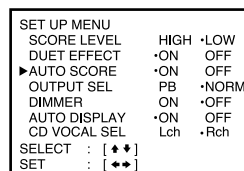

Tips

- The highest possible score is 99 points.
- To display your score on the TV screen again, press DISPLAY.
- The highest score is cleared each time you press KARAOKE (ON/OFF) to turn off the button.

Notes

- The grading is not absolute. Please use this function for your own amusement.
- AUTO SCORE works only while playing programmed songs.
- When the sound level of a source is too low, the score may not be correct.

Recording your karaoke singing

You can record your singing with picture and sound of VIDEO CD on a video tape. Sound from the microphone is recorded on the normal track together with left sound and right sound of VIDEO CD.

Before you start...

- Connect the microphone(s) to the MIC IN 1 and/or 2 jack(s), and its control plug to the CONTROL jack. And then set the SELECTOR on the microphone to KEY or S.D.

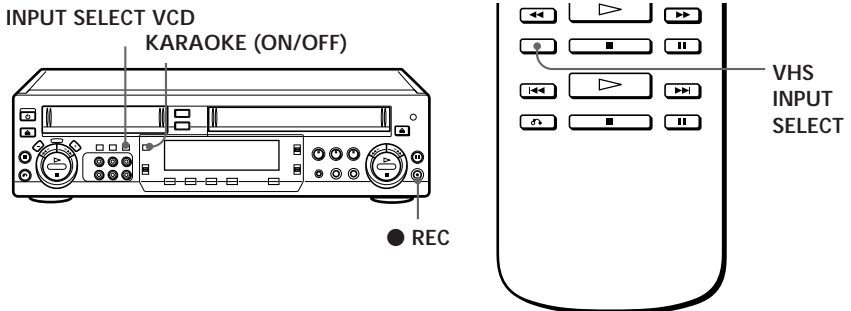

- 1 Press KARAOKE (ON/OFF).
The KARAOKE (ON/OFF) button lights up.
- 2 Press INPUT SELECT VCD (or press VHS INPUT SELECT on the remote repeatedly until "VCD" appears).
- 3 Press ● REC, and enjoy playing karaoke.

To stop recording

Press ■ STOP.

Tip

- You can control the volume of the sound from a microphone using MIC VOL 1 or MIC VOL 2.

Precautions

Precautions

Safety

- Caution - The use of optical instruments with this product will increase eye hazard.
- This player operates on 110 – 240 V AC, 50/60 Hz. Check that the unit's operating voltage is identical with your local power supply.
- If anything falls into the cabinet, unplug the unit and have it checked by qualified personnel before operating it any further.
- The unit is not disconnected from the mains as long as it is connected to the mains, even if the unit itself has been turned off.
- Unplug the unit from the mains if you do not intend to use it for an extended period of time. To disconnect the cord, pull it out by the plug, never by the cord.
- Should the AC power cord (mains lead) need to be changed, have it done at a qualified service shop only.

Installing

- Allow adequate air circulation to prevent internal heat buildup.
- Do not place the unit on surfaces (rugs, blankets, etc.) or near materials (curtains, draperies) that may block the ventilation slots.
- Do not install the unit near heat sources such as radiators or air ducts, or in a place subject to direct sunlight, excessive dust, mechanical vibration or shock.
- Do not install the unit in an inclined position. It is designed to be operated in a horizontal position only.
- Keep the unit and cassettes away from equipment with strong magnets, such as microwave ovens or large loudspeakers.
- Do not place heavy objects on the unit.
- If the unit is brought directly from a cold to a warm location, moisture may condense inside the unit and cause damage to the video head and tape. When you first install the unit, or when you move it from a cold to a warm location, wait for about one hour before operating the unit.
- Do not turn up the volume while listening to a portion with very low level inputs or no audio signals. If you do, the speakers may be damaged when a peak level portion is played.
- Clean the cabinet, panel and controls with a soft cloth slightly moistened with a mild detergent solution. Do not use any type of abrasive pad, scouring powder or solvent such as alcohol or benzene.

Notes on Discs

On handling discs

- To keep the disc clean, handle the disc by its edge. Do not touch the surface.
- Do not stick paper or tape on the disc. If there is glue (or a similar substance) on the disc, remove the glue completely before using the disc.

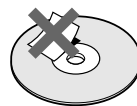

Not this way

- Do not expose the disc to direct sunlight or heat sources such as hot air ducts, or leave it in a car parked in direct sunlight as there can be considerable rise in temperature inside the car.
- After playing, store the disc in its case.

On cleaning

- Before playing, clean the disc with a cleaning cloth. Wipe the disc from the center out.

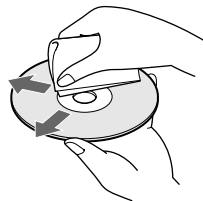



- Do not use solvents such as benzene, thinner, commercially available cleaners or anti-static spray intended for vinyl LPs.

Troubleshooting

If you have any questions or problems not covered below, please consult your nearest Sony service facility.

	Symptom	Remedy
Power	The ON/STANDBY switch does not function.	<ul style="list-style-type: none"> • Connect the mains lead securely.
	The power is turned on but this player does not operate.	<ul style="list-style-type: none"> • Moisture condensation occurs. Turn the power off, unplug the mains lead and leave this player to dry for over an hour. • There's no disc inside the VCD part ("no disc" appears). Insert a disc. • Insert the disc with the label side up on the disc tray of the VCD part correctly. • Clean the disc (VIDEO CD or Audio CD).
	The playback picture does not appear on the TV screen.	<ul style="list-style-type: none"> • Make sure the TV is set to the video channel. If you are using a monitor, set it to video input. • Check that the player is connected securely. • Make sure you set the COLOR SYSTEM switch correctly, according to your TV.
Playback	The picture is not clear.	<ul style="list-style-type: none"> • Adjust the tracking with the ▼/▲ TRACKING NORMAL/SLOW STILL/ADJUST buttons when using a video tape. • Make sure the COLOR SYSTEM switch is set to the position corresponding to the colour system which the tape was recorded with. • The video heads of VHS part are dirty (see below). Clean the video heads using the Sony V-25CL video head cleaning cassette. If this cleaning cassette is not available in your area, have the heads cleaned at your nearest Sony service facility (a standard service charge will be required). Do not use a commercially available wet-type cleaning cassette, as it may damage the video heads. • The video heads of VHS part may have to be replaced. Consult your local Sony service facility for more information.

Symptoms caused by contaminated video heads of VHS part

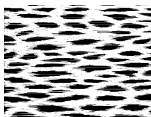
• Normal picture	• Rough picture	• Unclear picture	• No picture (or black & white screen appears)
			
	initial	→	terminal

	Symptom	Remedy
Playback	The picture rolls vertically during picture search.	<ul style="list-style-type: none"> Adjust the vertical hold control on the TV or monitor.
	The picture has no sound	<ul style="list-style-type: none"> The tape is defective. Use a new tape. Check that the player is connected securely. Make sure you operate the TV or the amplifier correctly. Make sure you select the correct position on the amplifier.
	The sound is unstable or has an echo.	<ul style="list-style-type: none"> When you play a tape with the same sound recorded on both the hi-fi and normal sound tracks, make sure the AUDIO MIX option in SET UP VHS is set to OFF.
	The sound loses stereo effect.	<ul style="list-style-type: none"> “R ch” or “L ch” appears in the display window .
	The player doesn't play from the first track when playing a VIDEO CD without PBC functions or an audio CD.	<ul style="list-style-type: none"> Press CONTINUE. “CONTINUE” appears in the display window, then press ▷.
Recording	The tape starts playing as soon as it is inserted.	<ul style="list-style-type: none"> The safety tab of the video tape has been removed. To record on this tape, cover the tab hole.
	The tape is ejected when you press ● REC.	<ul style="list-style-type: none"> Check that the safety tab of the video tape has not been removed.
	Nothing happens when you press ● REC.	<ul style="list-style-type: none"> Make sure the tape is not at its end. Select the correct source with the INPUT SELECT buttons.
Others	No tape can be inserted.	<ul style="list-style-type: none"> Check that a tape isn't already in the tape compartment of the VHS part.
	The remote commander does not function.	<ul style="list-style-type: none"> Make sure you are pointing the remote commander at the remote sensor on the player. Remove the obstacles in the path of the remote and the player. Replace all the batteries in the remote commander with new ones if they are weak. Make sure the [TV] / [VCD/VHS] remote control switch is set correctly.
	The tracking indicator does not appear on the screen.	<ul style="list-style-type: none"> The recording condition of the tape is very poor and tracking cannot be adjusted in the VHS part, or the NTSC system is being used.
	The player needs to be cleaned.	<ul style="list-style-type: none"> Clean the cabinet, panel, and controls with a dry soft cloth, or a soft cloth slightly moistened with a mild detergent solution. Do not use any type of solvent, such as alcohol or benzine.
	The AMS function does not work properly in the KARAOKE mode.	<ul style="list-style-type: none"> The tape has too many blank spaces in a short time span.
	The sound from the microphone does not go out in the KARAOKE mode.	<ul style="list-style-type: none"> When the player is in stop mode, the sound from the microphone may not go out. To hear the sound in stop mode, press INPUT SELECT 2 (page22).

Specifications

System

- RF output signal
 - UHF channels 30 to 39
- Aerial out
 - 75-ohm asymmetrical aerial socket

VCD part

- Laser
 - Semiconductor laser
- Wavelength
 - 780 - 790 nm
- Signal format system
 - NTSC, PAL
- Frequency response
 - 2 Hz to 20 kHz ± 0.5 dB
- Signal-to-noise ratio
 - More than 105 dB
- Harmonic distortion
 - Less than 0.0022%

Inputs and outputs

- LINE-1/2 IN
 - VIDEO IN, phono jack (1 each)
Input signal: 1 Vp-p, 75 ohms,
unbalanced, sync negative
 - AUDIO IN, phono jack (2 each)
Input level: 327 mVrms
Input impedance: more than 47 kilohms
- LINE 1/2 OUT
 - VIDEO OUT, phono jack (1)
Output signal: 1 Vp-p, 75 ohms,
unbalanced, sync negative
 - AUDIO OUT, phono jack (2)
Standard output: 327 mVrms
Load impedance: 47 kilohms
Output impedance: less than 10 kilohms
- Video CD DIRECT OUT
 - VIDEO OUT, phono jack (1)
Output signal: 1 Vp-p, 75 ohms,
unbalanced, sync negative
 - AUDIO OUT, phono jack (2)
Standard output: 2.0 Vrms max
Load impedance: 47 kilohms
Output impedance: less than 600 ohms

General

- Power requirements
 - 110 - 240 V AC, 50/60 Hz
- Power consumption
 - 30 W
- Operating temperature
 - 5°C to 40°C
- Storage temperature
 - 20°C to 60°C
- Dimensions
 - Approx. 430 x 119 x 384 mm (w/h/d)
including projecting parts and controls
- Mass
 - Approx. 7.0 kg

Supplied accessories

- Remote commander (1)
- R6 (Size AA) batteries (2)
- Aerial cable (1)
- Mains lead (1)
- Audio/video cable (3-phono to 3-phono) (1)
- Microphone (1)
- Plug adaptor (SLV-7000K CH only) (1)

Design and specifications are subject to change without notice.

Index to parts and controls

Refer to the pages indicated in parentheses () for details.

Front panel

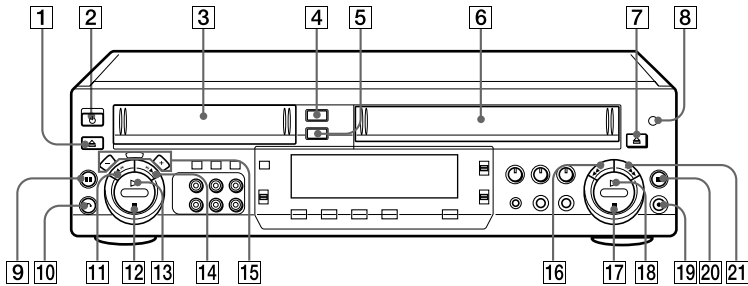

- | | |
|----------------------------------------------------|------------------------------------------------------|
| 1 VIDEO CD/Audio CD OPEN/CLOSE button (16) | 12 VIDEO CD/Audio CD STOP button (17) |
| 2 ON/STANDBY switch/indicator (8) | 13 VIDEO CD/Audio CD PLAY/SELECT button (17) |
| 3 VIDEO CD/Audio CD compartment | 14 VIDEO CD/Audio CD NEXT button (17) |
| 4 OUT PUT SELECT VHS button (13) | 15 MENU +/- buttons (52) |
| 5 OUT PUT SELECT VCD button (17) | 16 VHS REW/SEARCH button (12) |
| 6 Tape compartment | 17 VHS STOP button (12) |
| 7 Video tape EJECT button (12) | 18 VHS PLAY button (11) |
| 8 Remote sensor (5) | 19 VHS REC button (28) |
| 9 VIDEO CD/Audio CD PAUSE button (17) | 20 VHS PAUSE button (12) |
| 10 VIDEO CD RETURN button (52) | 21 VHS FF/SEARCH button (12) |
| 11 VIDEO CD/Audio CD PREV button (17) | |

continued

Index to parts and controls (continued)

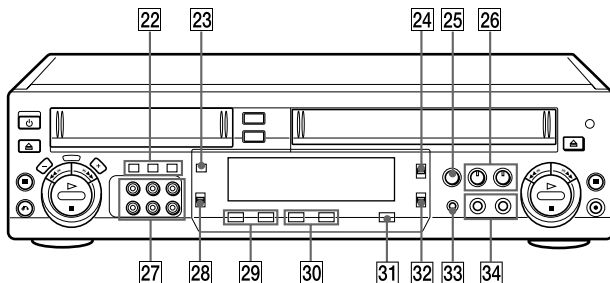

22 INPUT SELECT (VHS) buttons
(8,28,31,60)

23 KARAOKE (ON/OFF) button (23)

24 COLOR SYSTEM switch (12)

25 ECHO control (23)

26 MIC VOL 1/2 controls (23)

27 LINE-2 IN/OUT VIDEO AUDIO L/
R jacks (30)

28 KARAOKE MODE switch (56)

29 KEY CONTROL **b/#** buttons (57)

30 SELF DUET **b/#** buttons (58)

31 SCORE button (59)

32 SOUND EFFECTOR switch
(12,17,24)

33 CONTROL jack (22)

34 MIC IN 1/2 jacks (22)

Display window

You can make the display window dim. Press MENU and select SET UP MENU, then set DIMMER to ON.

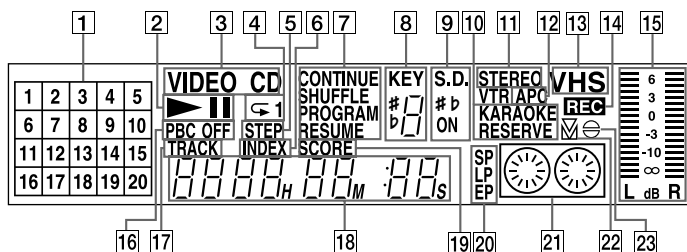

- | | | | |
|----|--------------------------------------------------------|----|----------------------------------------------------|
| 1 | Music calendar (19) | 13 | VHS indicator |
| 2 | CD operating indicator | 14 | VHS REC indicator (28) |
| 3 | CD/VIDEO CD indicator | 15 | Audio channel/sound level indicator |
| 4 | Repeat indicator (45) | 16 | PBC indicator (51) |
| 5 | STEP indicator (49) | 17 | TRACK indicator (19) |
| 6 | INDEX indicator (43) | 18 | Time counter/programme position indicator (13, 48) |
| 7 | CONTINUE/SHUFFLE/PROGRAM/RESUME indicator (41, 47, 48) | 19 | SCORE indicator (59) |
| 8 | Key control indicators (57) | 20 | Tape speed indicator (28) |
| 9 | S.D. indicators (58) | 21 | Tape indicator |
| 10 | APC indicator (34) | 22 | Tracking indicator (34) |
| 11 | STEREO indicator (32) | 23 | Audio dubbing indicator (36) |
| 12 | KARAOKE RESERVE indicator (54) | | |

continued

Index to parts and controls (continued)

Rear panel

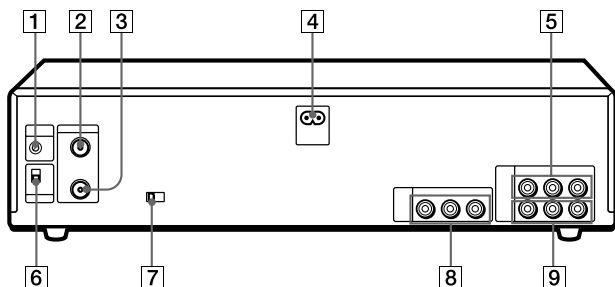

1 RF CHANNEL screw (9)

2 AERIAL OUT connector (7)

3 AERIAL IN connector (7)

4 AC IN connector (6)

5 LINE-1 OUT VIDEO/AUDIO L/R
jacks (6)

6 TV SYSTEM switch (9)

7 NTSC PB switch (9)

8 LINE-1 IN VIDEO/AUDIO L/R
jacks (8,28)

9 Video CD DIRECT OUT VIDEO/
AUDIO L/R jacks (7)

Remote commander

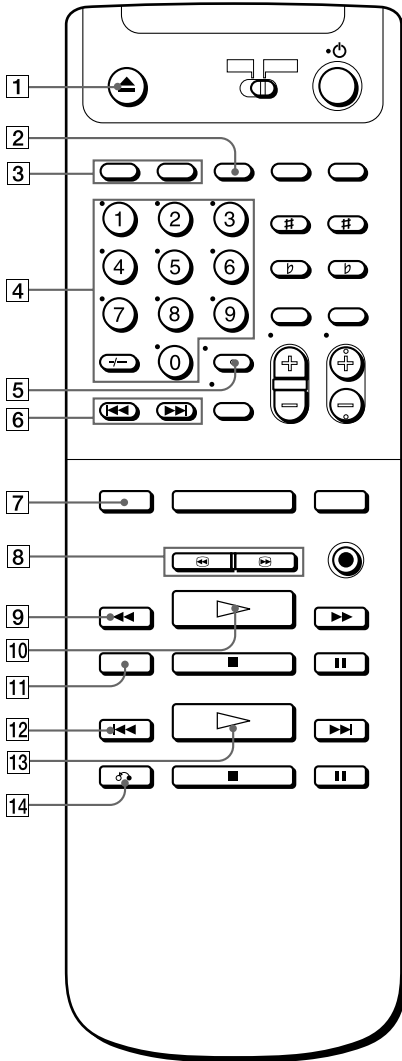

- 1 VHS ▲ EJECT button (12)
- 2 VIDEO CD SCENE button (39)
- 3 TRINITRON TV SYNCHRO PLAY VHS/VCD buttons (14, 18)
- 4 Programme number/ -/-- (ten's digit) buttons (39,48,51)
- 5 DISPLAY button (13,20)
- 6 ◀◀ / ▶▶ INDEX SEARCH buttons (33)
- 7 OUTPUT SELECT VCD button (17)
- 8 VHS ◀▶ SEARCH buttons (12)
- 9 VHS ◀◀ REW button (12)
- 10 VHS ▷▶ PLAY button (11)
- 11 VHS INPUT SELECT button (8,28,31,60)
- 12 VCD ◀◀ PREV button (17)
- 13 VCD ▷▶ PLAY/SELECT button (17)
- 14 VCD ↻ PBC RETURN button (52)

continued

Index to parts and controls (continued)

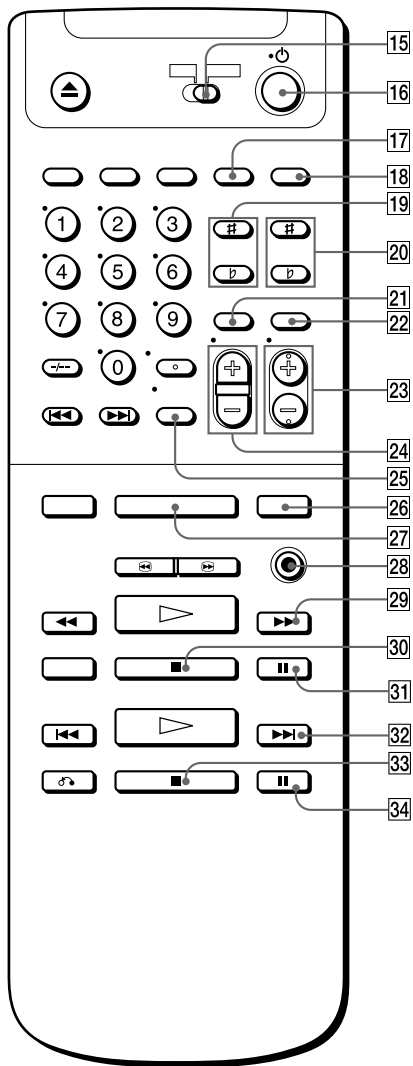

- 15 TV/VCD/VHS remote control switch (5)
- 16 ⏻ (on/standby) switch (8)
- 17 VIDEO CD INDEX button (43)
- 18 SCORE button (59)
- 19 SELF DUET #/b buttons (58)
- 20 KEY CONTROL #/b buttons (57)
- 21 RESERVE button (54)
- 22 EXECUTE button (54)
- 23 PROG +/- buttons (28) (for TV)
- 24 VOL +/- buttons (for TV)
- 25 TV/VIDEO button (for TV)
- 26 OUTPUT SELECT VHS button (13)
- 27 KARAOKE button (25)
- 28 VHS ● REC button (28)
- 29 VHS ►► FF button (12)
- 30 VHS ■ STOP button (12)
- 31 VHS || PAUSE button (12)
- 32 VCD ►►| NEXT button (17)
- 33 VCD ■ STOP button (17)
- 34 VCD || PAUSE button (17)

Remote commander (in the lid)

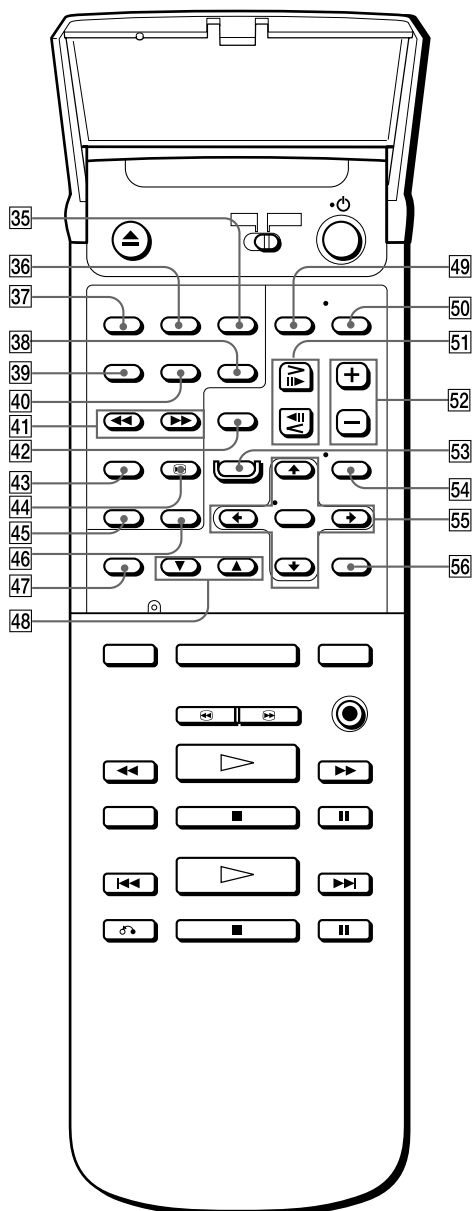

- 35 CHECK button (50)
- 36 CLEAR button (49)
- 37 PROGRAM button (48)
- 38 SHUFFLE button (47)
- 39 CONTINUE button (47)
- 40 REPEAT button (45)
- 41 ◀◀/▶▶ SEARCH buttons (17)
- 42 TAPE SPEED button (28)
- 43 SLOW button (42)
- 44 ⏸ LOCKED SEARCH buttons (17)
- 45 PBC ON/OFF button (52)
- 46 TIME button (19)
- 47 TRACKING AUTO/MAN button (34)
- 48 ▼/▲ TRACKING NORMAL/SLOW/STILL/ADJUST buttons (34)
- 49 ×2 button (26)
- 50 AUDIO MONITOR button (32)
- 51 ◀◀|||▶▶ FRAME/</> buttons (26)
- 52 SLOW SPEED +/- buttons (26)
- 53 AUDIO DUB button (36)
- 54 MENU button (10, 35)
- 55 CURSOR ↑/↓/←/→ buttons (10, 35)
- EXE button (10, 35)
- 56 COUNTER RESET button (13)