

SONY®

2-669-084-13 (1)

Operating Instructions

MZ-RH1

MZ-M200

Hi-MD Walkman®

Portable MD Recorder



Hi-MD
AUDIO

Mini
Disc

Net MD

MDLP

“WALKMAN” and “WALKMAN” logo are registered trademarks of Sony Corporation.



WARNING

To reduce the risk of fire or electric shock, do not expose this apparatus to rain or moisture.

Do not install the appliance in a confined space, such as a bookcase or built-in cabinet.

To reduce the risk of fire, do not cover the ventilation of the apparatus with newspapers, table-cloths, curtains, etc. And do not place lighted candles on the apparatus.

To reduce the risk of fire or electric shock, do not place objects filled with liquids, such as vases, on the apparatus.

Certain countries may regulate disposal of the battery used to power this product. Please consult with your local authority.

Caution

The use of optical instruments with this product will increase eye hazard.

CAUTION – INVISIBLE LASER
RADIATION WHEN OPEN

AVOID EXPOSURE TO BEAM

CAUTION – CLASS 1M INVISIBLE
LASER RADIATION WHEN OPEN

DO NOT VIEW DIRECTLY WITH
OPTICAL INSTRUMENTS

CAUTION

Danger of explosion if battery is incorrectly replaced. Replace only with the same or equivalent type.

Information

IN NO EVENT SHALL SELLER BE
LIABLE FOR ANY DIRECT,
INCIDENTAL OR
CONSEQUENTIAL DAMAGES OF
ANY NATURE, OR LOSSES OR
EXPENSES RESULTING FROM
ANY DEFECTIVE PRODUCT OR
THE USE OF ANY PRODUCT.

For customers who purchased this product in the USA

Owner's Record

The serial number is located at the rear of the disc compartment lid and the model number is located at the rear. Record the serial and the model numbers in the space provided below. Refer to them whenever you call upon your Sony dealer regarding this product.

Model No. _____

Serial No. _____

Product registration

Please register this product on line at
www.sony.com/walkmanreg
<<http://www.sony.com/walkmanreg>>

Proper registration will enable us to send you periodic mailings about software upgrades, new products, services and other important announcements. Thank you.

**If you have any questions about this product,
contact:**
www.sony.com/walkmansupport

Sony Network Portable Audio Support Line
1-(866)-456-7669

Sony Customer Information Services Center
12451 Gateway Blvd., Ft. Myers, FL 33913

Declaration of Conformity

Trade Name: SONY

Model No.: MZ-RH1, MZ-M200

Responsible Party: Sony Electronics Inc.

Address: 16530 Via Esprillo, San Diego, CA 92127 USA

Telephone No.: 858-942-2230

This device complies with Part 15 of the FCC Rules. Operation is subject to the following two conditions: (1) This device may not cause harmful interference, and (2) this device must accept any interference received, including interference that may cause undesired operation.

This equipment has been tested and found to comply with the limits for a Class B digital device, pursuant to Part 15 of the FCC Rules. These limits are designed to provide reasonable protection against harmful interference in a residential installation.

This equipment generates, uses, and can radiate radio frequency energy and, if not installed and used in accordance with the instructions, may cause harmful interference to radio communications. However, there is no guarantee that interference will not occur in a particular installation. If this equipment does cause harmful interference to radio or television reception, which can be determined by turning the equipment off and on, the user is encouraged to try to correct the interference by one or more of the following measures:

- Reorient or relocate the receiving antenna.
- Increase the separation between the equipment and receiver.
- Connect the equipment into an outlet on a circuit different from that to which the receiver is connected.
- Consult the dealer or an experienced radio/TV technician for help.

You are cautioned that any changes or modifications not expressly approved in this manual could void your authority to operate this equipment.

For the customers in the USA and Canada only

RECYCLING LITHIUM-ION BATTERIES

Lithium-ion batteries are recyclable.

You can help preserve our environment by returning your used rechargeable batteries to the collection and recycling location nearest you.

For more information regarding recycling of rechargeable batteries, call toll free 1-800-822-8837, or visit <http://www.rbrc.org/>

Caution: Do not handle damaged or leaking Lithium-ion batteries.



The validity of the CE marking is restricted to only those countries where it is legally enforced, mainly in the countries EEA (European Economic Area).

Disposal of Old Electrical & Electronic Equipment (Applicable in the European Union and other European countries with separate collection systems)



This symbol on the product or on its packaging indicates that this product shall not be treated as household waste. Instead it shall be handed over to the applicable collection point for the recycling of electrical and electronic equipment. By ensuring this product is disposed of correctly, you will help prevent potential negative consequences for the environment and human health, which could otherwise be caused by inappropriate waste handling of this product. The recycling of materials will help to conserve natural resources. For more detailed information about recycling of this product, please contact your local Civic Office, your household waste disposal service or the shop where you purchased the product. Applicable accessories: Remote control, Earphones

For the customers in Netherlands

Voor de Klanten in Nederland



Gooi de batterij niet weg
maar lever deze in als klein
chemisch afval (KCA).

For the customers in Russia

Для покупателей в России



Этот знак относится
к прилагаемому
адаптеру переменного
тока.

Портативный плеер мини-дисков.

Сделано в Малайзии

Изготовитель: Сони Корпорейшн

Адрес: 1-7-1 Конан, Минато-ку,
Токио 108-0075, Япония

Table of Contents

Notice for Users	6
What you can do with this product.....	8

Getting Started

Checking the supplied accessories.....	9
Guide to Parts and Controls.....	12
Preparing a Power Source	14
The types of discs that you can use	17
About the recorder operation modes	17

Using the recorder with a computer

What you can do through connection with a computer	18
Installing the SonicStage/MD Simple Burner software.....	19
System requirements	19
Installing SonicStage/MD Simple Burner onto your computer	20
Connecting the recorder to your computer	21
Using SonicStage	23
Importing audio data	23
Transferring audio data from your computer to the recorder.....	24
Transferring audio data from the recorder to your computer.....	25
Viewing SonicStage Help.....	26
Using MD Simple Burner	27
Recording using the recorder operations (Simple mode).....	27
Recording by computer operations (Standard mode).....	28
Storing non-audio data to a disc	30

Recording on a disc

Recording on a disc	31
Displayed items during recording	35
Recording from externally connected component	37

Playing a disc

Playing a disc	39
Displayed items during playback	41
Selecting the play mode	43
Playing tracks in the selected play mode..	43
Listening to selected tracks only (Bookmark Play)	43
Playing tracks repeatedly (Repeat Play)...	44
Listening to a section of a track repeatedly (A-B Repeat)	44
Adjusting the sound	45
Varying the virtual sound to create different acoustics (Virtual-Surround)	45
Selecting the sound quality (6-Band Equalizer)	45
Normalizing the playback sound level automatically (Dynamic Normalizer)	46

Editing

Dividing a track (Divide)	47
Adjusting the dividing point before dividing a track (Divide Rehearsal)	47
Combining tracks (Combine)	48

Using the Menu

Using the Menu	49
Menus for recording	50
Adjusting the recording level manually ...	52
Menu for playback	53
Menus for editing	54
Menus on the recorder.....	54
Menus on the remote	54
Moving a track on a disc	56
Changing the order of a group on a disc ..	56
Adding titles (Title Input)	57
Option menus	58
Setting the clock.....	61

Troubleshooting

Troubleshooting	62
Messages	71

Additional Information

Precautions	75
Specification	78
Explanations	80
Index	85

Notice for Users

On the supplied SonicStage/MD Simple Burner software

- Copyright laws prohibit reproducing the software or the manual accompanying it in whole or in part, or renting the software without the permission of the copyright holder.
- In no event will SONY be liable for any financial damage, or loss of profits, including claims made by third parties, arising out of the use of the software supplied with this recorder.
- In the event a problem occurs with this software as a result of defective manufacturing, SONY will replace it. However, SONY bears no other responsibility.
- The software provided with this recorder cannot be used with equipment other than that which is so designated.
- Please note that, due to continued efforts to improve quality, the software specifications may be changed without notice.
- Operation of this recorder with software other than that provided is not covered by the warranty.
- The ability to display the languages on the software will depend on the installed OS on your PC. For better results, please ensure that the installed OS is compatible with the desired language you want to display.
 - We do not guarantee all the languages will be able to be displayed properly on the software.
 - User-created characters and some special characters may not be displayed.
- Depending on the type of the text and characters, the text shown on the software may not be displayed properly on the device. This is due to:
 - The capability of the connected device.
 - The device is not functioning normally.

Trial recording

Before you record one-time events, you may want to make a trial recording to make sure that the recorder is working correctly.

No compensation for recording failures

Sony cannot provide compensation for any failure in recording caused by a malfunction in this recorder or the recording media, etc.

Precaution on copyright

Television programs, films, video tapes, and other materials may be copyrighted. Unauthorized recording of such materials may be contrary to the provision of the copyright laws.

Trademarks

- SonicStage is a trademark or registered trademark of Sony Corporation.
- MD Simple Burner, OpenMG, “MagicGate”, “MagicGate Memory Stick”, “Memory Stick”, Hi-MD, Net MD, **ATRAC**, **ATRAC3**, **ATRAC3plus** and their logos are trademarks of Sony Corporation.
- Microsoft, Windows, Windows NT and Windows Media are trademarks or registered trademarks of Microsoft Corporation in the United States and /or other countries.
- IBM and PC/AT are registered trademarks of International Business Machines Corporation.
- Macintosh is a trademark of Apple Computer, Inc.
- Pentium is a trademark or registered trademark of Intel Corporation.
- MPEG Layer-3 audio coding technology and patents licensed from Fraunhofer IIS and Thomson.
- All other trademarks and registered trademarks are trademarks or registered trademarks of their respective holders.
- ™ and ® marks are omitted in this manual.
- CD and music-related data from Gracenote, Inc., copyright © 2000-2004 Gracenote. Gracenote CDDB® Client Software, copyright 2000-2004 Gracenote. This product and service may practice one or more of the following U.S. Patents: #5,987,525; #6,061,680; #6,154,773, #6,161,132, #6,230,192, #6,230,207, #6,240,459, #6,330,593, and other patents issued or pending. Services supplied and/or device manufactured under license for following Open Globe, Inc. United States Patent 6,304,523. Gracenote is a registered trademarks of Gracenote. The Gracenote logo and logotype, and the “Powered by Gracenote” logo are trademarks of Gracenote.

Program © 2001, 2002, 2003, 2004, 2005

Sony Corporation

Documentation © 2006 Sony Corporation

What you can do with this product

Not only can you record and play music data on this recorder, you can also transfer audio data to it from a computer using the supplied SonicStage software. Furthermore, you can transfer audio data that you've recorded directly on the recorder or another MD component to the computer, and then manage the data on the computer.

Recording (☞ page 31)

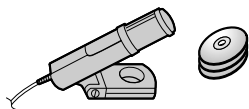

Recording by microphone
Digital recording
Analog recording

Playing (☞ page 39)

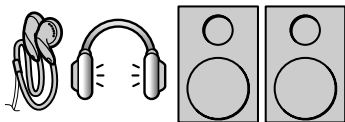

The supplied/optional headphones/
earphones, speakers, stereo system, etc.

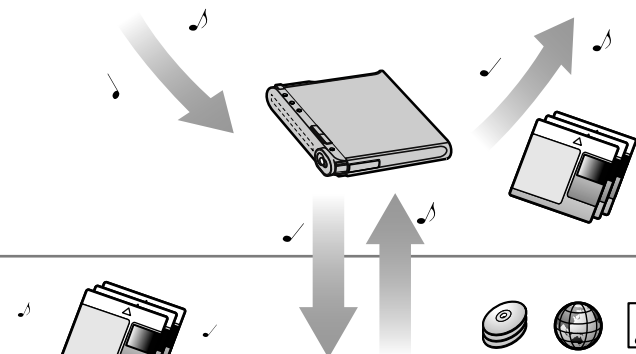

Transfer music data
recorded on the recorder
or another MD component
from the recorder to the
computer

Transfer audio data to the
recorder
(LinearPCM/ATRAC/MP3)

Audio CDs, Internet, Music Files, etc.
(You can also transfer non audio
data, such as text data, image data,
etc. to the recorder.)

Using the recorder with a computer (☞ page 18)

Checking the supplied accessories

- AC power adaptor
- AC power cord¹⁾ (100 V - 240 V)

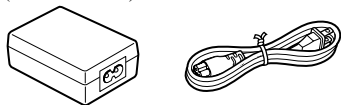

- USB cable



- Remote control²⁾
- Earphones



- LIP-4WM Lithium-ion rechargeable battery
- Rechargeable battery case

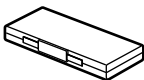

- Stereo microphone (MZ-M200 only)



- Optical cable (for the European, Asian and Chilean models)
- Carrying pouch
- Ferrite core (small size)
 - Three for the European, Asian and Chilean models
 - Two for the MZ-RH1 North American and Latin American models
 - One for the MZ-M200 North American model
- 1GB Hi-MD disc (except for the European, Asian and Chilean models)

- CD-ROM³⁾ (Windows: SonicStage/MD Simple Burner, Macintosh: Hi-MD Music Transfer for Mac)
- Operating Instructions (this manual)
- Operating Instructions (Hi-MD Music Transfer for Mac)

¹⁾ The shape of the plug differs according to the region where the recorder was purchased. Two cords with differently shaped plugs are supplied with the models for Europe, Asia and Chile. Use the one that corresponds with the outlet configuration in the region where it is used.

²⁾ For the North American and Latin American models, remote with a ferrite core is supplied.

³⁾ Do not play a CD-ROM on an audio CD player. For details on "Hi-MD Music Transfer for Mac", refer to the instruction sheet supplied with this recorder.

Note

When using this recorder, remember to follow the precautions below in order to avoid warping the cabinet or causing the recorder to malfunction.

- Make sure not to sit down with the recorder in your back pocket.



- Make sure not to put the recorder into a bag with the remote or the headphones/earphones cord wrapped around it and then subject the bag to strong impact.

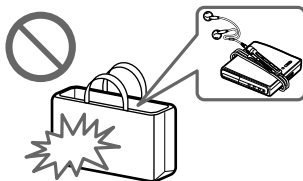

How to use the supplied ferrite core

This recorder comes with ferrite cores for connection to the supplied remote, the optional stereo microphone and the optional line cable. (You must attach the ferrite cores to comply with the applicable EMC standards.) Be sure to connect them when using the recorder with a computer. If not, there is no need to connect them.

1 Open the ferrite core.

For the European, Asian and Chilean models:



ESD-SR-110 for the supplied remote and the optional stereo microphone

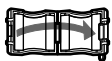

2017-0930 for the optional line cable

For the MZ-RH1 North American and Latin American models:



ESD-SR-110 for the optional stereo microphone and the optional line cable

For the MZ-M200 North American model:



ESD-SR-110 for the optional line cable

2 Wind the cord around the ferrite cores as follows.

For the European, Asian and Chilean models:

- For the supplied remote control: Wind the cord around the ferrite core once/ Approx. 4 cm (1.6 in.) from the plug
- For the optional stereo microphone: Wind the cord around the ferrite core twice/ Approx. 1 cm (0.6 in.) from the plug
- For the optional line cable: Wind the cord around the ferrite core once/ Approx. 1 cm (0.6 in.) from the plug

For the MZ-RH1 North American and Latin American models:

- For the optional stereo microphone: Wind the cord around the ferrite core twice/ Approx. 1 cm (0.6 in.) from the plug

- For the optional line cable: Pass the cord through the ferrite core/ Approx. 1 cm (0.6 in.) from the plug

For the MZ-M200 North American model:

- For the optional line cable: Pass the cord through the ferrite core/ Approx. 1 cm (0.6 in.) from the plug

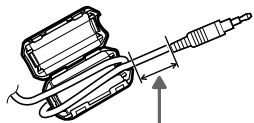

Refer to step 2 for the distance from the plug connected to the recorder.

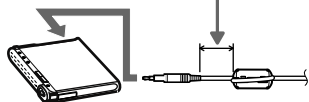

3 Close the ferrite core. Make sure the clasps are fully engaged.



To attach the clip in the opposite direction

1 Remove the clip.

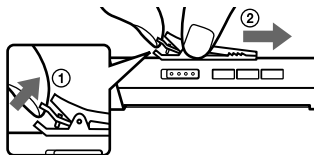

2 Attach the clip in the opposite direction.

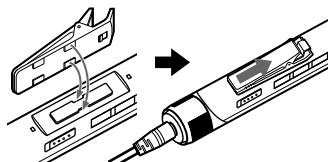

Optional accessories

- Optical cable POC-15B, POC-15AB
- Line cable RK-G129, RK-G136
- Stereo microphones ECM-MS907, ECM-719
- MDR-series Stereo Headphones/earphones*
- SRS-series Active Speakers
- Recordable MDs ES-series
- 1GB Hi-MD disc HMD1GA
- LIP-4WM Lithium-ion rechargeable battery

* When using optional headphones/earphones, use only headphones/earphones with stereo mini plugs. You cannot use headphones/earphones with micro plugs.

You cannot use as follows.

- Rotally commander RM-WMC1
- MD label printer MZP-1
- IC memory repeat learning MD controller RPT-M1

Your dealer may not handle some of the above listed accessories. Please ask the dealer for detailed information about the accessories in your country.

Guide to Parts and Controls

Recorder

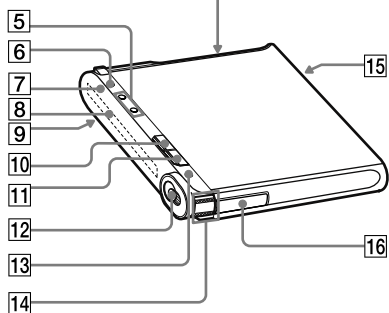
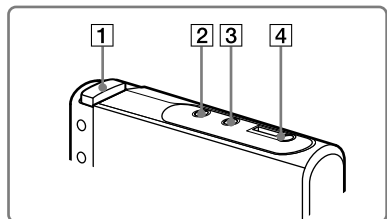

Remote

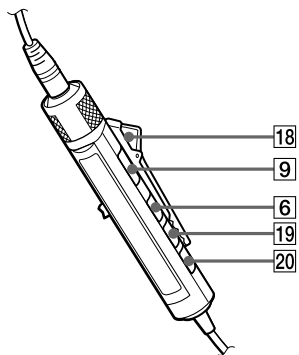
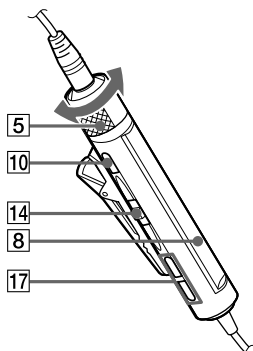

- 1 OPEN button (☞ pages 31, 39)
- 2 LINE IN (OPT) jack (☞ page 37)
- 3 MIC (PLUG IN POWER)* jack (☞ page 31)
- 4 🎧 (earphones)/LINE OUT jack (☞ pages 39, 59)
- 5 Recorder: VOL +*/- buttons (☞ pages 39, 61)
Remote: VOL +/- control (☞ pages 39, 46)
- 6 Recorder: • DISPLAY/ ➔ MENU button (☞ pages 32, 35, 41, 49)
Remote: DISPLAY button (☞ pages 36, 42, 49)
- 7 Operation lamp (☞ pages 33, 35, 41)
- 8 Display window (☞ pages 35, 41)
- 9 HOLD switch (☞ page 15)
- 10 Recorder: ■ (stop) · CANCEL button (☞ pages 22, 33, 40, 49)
Remote: ■ (stop) button (☞ pages 40, 49)
- 11 || (pause) button (☞ pages 33, 40, 48)
- 12 REC switch (☞ pages 27, 33)
- 13 T MARK button (☞ pages 33, 47)
- 14 Recorder: Jog lever (▶ (play)/ENT*, FF (AMS, fast forward), FR (AMS, fast rewind)) (☞ pages 39, 47, 49)
- 15 USB cable connecting jack (☞ pages 14, 21, 37)
- 16 Battery compartment (☞ page 14)
- 17 📁 (group) +/- button (☞ pages 40, 58)
- 18 Clip (☞ page 10)
- 19 P MODE/↔ (repeat) button (☞ pages 43, 58)
- 20 SOUND button (☞ pages 45, 58)

* There is a tactile dot.

Locking the controls (HOLD)

Slide the HOLD switch [9] on the recorder or on the remote in the direction of the arrow. You can prevent accidental button presses while carrying the recorder by locking the controls. You can use the HOLD function for the recorder and the remote separately. For example, even if the HOLD function on the recorder is activated, you can operate the recorder by using the remote unless you set HOLD on the remote to on, too.

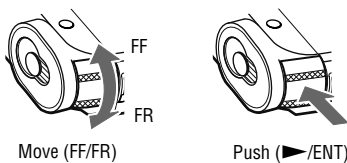

Remote: Jog lever (▶|| (play, pause)/ ENT, ◀◀ (AMS, fast rewind), ▶▶ (AMS, fast forward)) (☞ pages 39, 49)

Preparing a Power Source

Charge the rechargeable battery before using it for the first time or when it is depleted. Operations can be done on the recorder or the remote while charging.

- 1 Slide and open the battery compartment lid in the direction of the arrow.**



- 2 Insert the rechargeable battery.**
Insert it starting with the **+** and **-** terminal end.

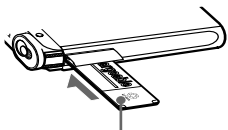

Insert the battery with the label side facing up.

- 3 Close the lid.**



- 4 Connect the AC power cord and the USB cable to the AC power adaptor.**

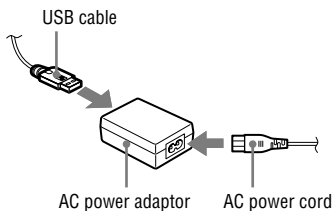

- 5 Connect the other end of the USB cable to the recorder and the AC power cord to a wall outlet.**

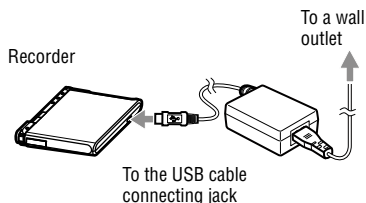

- 6 Confirm that charging has started.**

When charging starts,  and the charging time (“Charging --min left”) appear at the start of charging. When the charging time disappears, charging ends once and the battery becomes sufficiently charged. A completely depleted battery takes about one hour to reach this point, at which time it is approximately 80% charged. For a 100% charge, an additional 2 hours of charging is needed. If the charging time indication disappears after a short time, this means the battery is sufficiently charged.

Charging the rechargeable battery by computer connection (USB bus power)

You can charge the recorder's rechargeable battery by connecting the recorder to a USB port of a computer. When you connect the recorder to the computer, power (bus power) from the computer begins to charge the recorder's rechargeable battery.

A completely depleted battery attains about 80% charge in about one hour. For 100% charge, an additional 2 hours of charging is needed.

For connection details, refer to the "Connecting the recorder to your computer" (🔗 page 21).

Notes

- Power from the computer to the recorder stops when the computer changes to system suspend, sleep, or hibernation mode while the recorder is connected to the computer.
- When charging the rechargeable battery, make sure to insert the battery into the recorder before connecting the USB cable. If you insert the battery after connecting the USB cable, the battery may not be charged.
- Charge the rechargeable battery at a temperature of +5 °C (+41 °F) to +35 °C (+95 °F). The charging time may vary according to the recorder condition and the surrounding temperature.
- Repeated recharging causes the capacity of the rechargeable battery to decrease over time. As a result, the displayed charging time will become shorter as the battery is used.
- Stop the recorder before replacing the rechargeable battery.
- Connecting the recorder to a wall outlet is recommended during times of long use, as when recording.
- It is possible to do operations on the recorder or the remote while charging the battery with the AC power adaptor, as well as computer-related operations while charging with USB bus power. However, the charging time will be longer.
- When connecting the USB cable to the recorder, make sure not to touch the jog lever or buttons on the recorder. If the jog lever or any other buttons are pressed at the time you connect the USB cable, battery charging may not start.

To check the remaining power of the battery

The remaining power of the battery is indicated in the display as shown below. As the indicator decreases, the remaining power is depleted further.

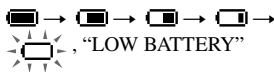

Notes

- The display shows the approximate battery power remaining.
- Depending on the operating conditions, the display may increase or decrease relative to the actual power remaining.

Before using the recorder

Make sure the recorder is not locked (🔗 page 13). Slide the HOLD switch on the recorder or on the remote in the opposite direction of the arrow.

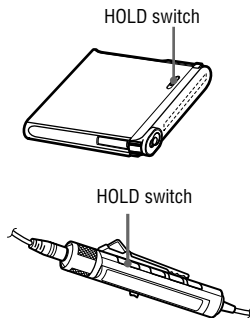

Battery life¹⁾

This value varies depending on how the recorder is used.

When recording/playing continuously in Hi-MD mode (Unit: approx. hours)

When	Disc type	LinearPCM	Hi-SP	Hi-LP	MP3 ²⁾
Recording	1GB Hi-MD disc	6	9	10.5	— ³⁾
	60/74/80-minute standard disc	5	9	10.5	— ³⁾
Playing	1GB Hi-MD disc	10	15.5	19	16.5
	60/74/80-minute standard disc	8	14.5	18.5	16

When recording/playing continuously in MD mode (Unit: approx. hours)

When	Disc type	SP	LP2	LP4
Recording	60/74/80-minute standard disc	8.5	10.5	12
Playing	60/74/80-minute standard disc	15.5	17.5	19

Measured in accordance with the JEITA (Japan Electronics and Information Technology Industries Association) standard.

¹⁾ Measured using a fully charged lithium-ion rechargeable battery with “EL Light” in the menu set to “Auto Off” (☞ page 59).

²⁾ When transferring at 128 kbps

³⁾ The recorder cannot record in MP3 mode. Transfer MP3 audio data using the supplied SonicStage software (☞ page 24).

Note

Repeated recharging causes the capacity of the rechargeable battery to decrease over time. As a result, the battery life will become shorter as the battery is used. Please replace the battery when the battery life reaches about half the time listed above.

The types of discs that you can use

This recorder supports the following discs:



1 GB Hi-MD disc



60/74/80-minute standard disc

About the recorder operation modes

The recorder has two operation modes, “Hi-MD mode” and “MD mode”.

The operation mode is automatically recognized whenever the disc is inserted.

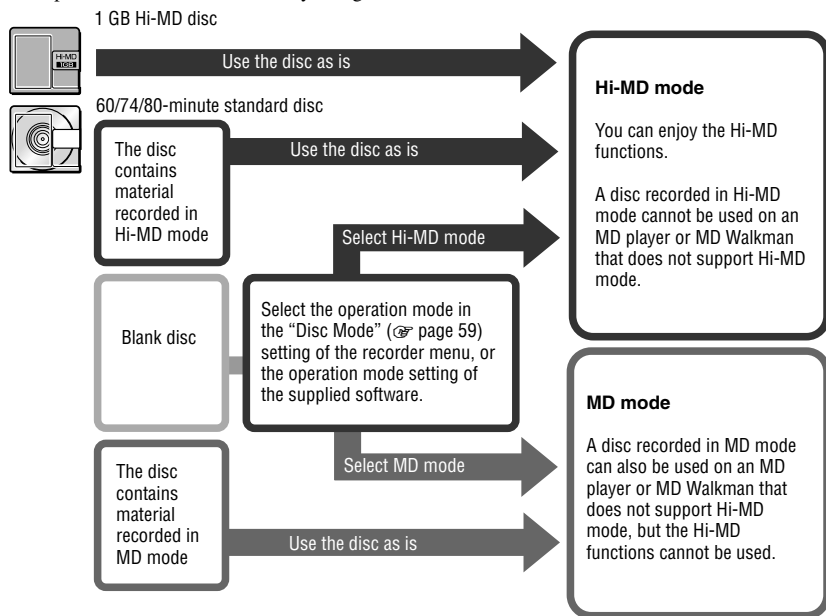

What you can do through connection with a computer

When using the supplied software

- **Transfer audio data between the computer and the recorder**

The supplied SonicStage software allows you to transfer audio data between the recorder and your computer. You can transfer audio data from the computer to the recorder or audio data that you have recorded on the recorder or another MD component to the computer. For detailed explanations, refer to SonicStage Help.

- **Record directly from a CD to an MD**

The supplied MD Simple Burner software enables you to record a CD in the computer's CD drive directly to a disc in the recorder.

When using the disc in the recorder as a storage device

When using the recorder in Hi-MD mode, the recorder appears in the Windows Explorer as an external drive, allowing you to transfer non-audio data such as text and image files. For details, refer to "Storing non-audio data to a disc" (🔍 page 30).

Charging the rechargeable battery of the recorder (USB bus power)

You can charge the rechargeable battery while the recorder is connected to a computer.

When using a Macintosh computer

Refer to the "Hi-MD Music Transfer for Mac" instruction sheet supplied with this recorder.



When playing audio files using the software, the sound is output from

- the computer's speakers when a disc used in Hi-MD mode is inserted; or
- the equipment such as earphones connected to the recorder when a disc used in MD mode is inserted.

Note

If the place where you charge the battery is too cold or too hot, the battery indication (🔋) will flash in the display and charging by USB bus power will not be possible. The battery should be charged within a temperature range of +5 °C (+41 °F) to +35 °C (+95 °F).

Installing the SonicStage/MD Simple Burner software

System requirements

The following system environment is required in order to use the SonicStage/MD Simple Burner software.

Computer	IBM PC/AT or Compatible	
	<ul style="list-style-type: none">• CPU: Pentium III 450 MHz or higher• Hard disk drive space: 200 MB or more (1.5 GB or more is recommended) (The amount space will vary according to Windows version and the number of music files stored on the hard disk.)• RAM: 128 MB or more	
	Others	<ul style="list-style-type: none">• CD drive (capable of digital playback by WDM) (A CD-R/RW drive is necessary for CD writing)• Sound Board• USB port
Operating System	Factory installed: Windows XP Media Center Edition 2005/Windows XP Media Center Edition 2004/Windows XP Media Center Edition/Windows XP Professional/Windows XP Home Edition/Windows 2000 Professional (Service Pack 3 or later)/Windows Millennium Edition/Windows 98 Second Edition	
Display	High Color (16 bit) or higher, 800 × 600 dots or better (1,024 × 768 dots or better is recommended)	
Others	<ul style="list-style-type: none">• Internet access for online registration and CDDB use• Internet access and Microsoft Internet Explorer (version 5.5 or higher) for use of EMD services• Windows Media Player (version 7.0 or higher) installed for playing WMA files	

This software is not supported by operating systems other than those listed above, custom-built PCs, operating systems that are upgrades from the original manufacturer-installed system, multi-boot environments, multi-monitor environments, or Macintosh computers.

Notes

- We do not ensure trouble-free operation on all computers that satisfy the system requirements.
- The NTFS format of Windows XP/Windows 2000 Professional can be used only with the standard (factory) settings.
- We do not ensure trouble-free operation of the system suspend, sleep, or hibernation function on all computers.

Installing SonicStage/MD Simple Burner onto your computer

Make sure to install the driver for this recorder from the supplied CD-ROM. If SonicStage, Net MD Simple Burner, or OpenMG Jukebox is already installed, the older version of the software will be overwritten by the new version. The functions and music data of the older version will be retained.

1 Close all Windows applications.

The following conditions may prevent a successful installation. Confirm whether they apply or not when installing the software.

- You did not logon as “Administrator” or “Computer Administrator” (when using Windows 2000/Windows XP)
- Virus-check software is activated. (Such software demands a large amount of system resources.)

2 Insert the supplied CD-ROM into the CD drive of your computer.

The setup program starts up automatically and the installation window appears.

3 When the [Region Selection] screen appears, select the region where the SonicStage software will be used, and then click [Next].

When the [Region Selection] screen does not appear, skip this step.

4 Click [Install SonicStage and MD Simple Burner] and then follow the displayed instructions.

Read the instructions carefully.

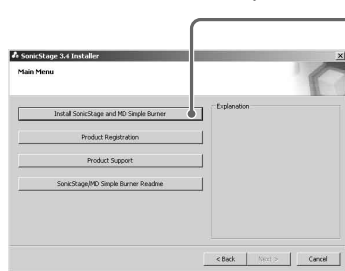

[Install SonicStage and MD Simple Burner]

The installation may take 20 to 30 minutes, depending on your system environment. Make sure to restart your computer only after the installation is completed.

Connecting the recorder to your computer

Connect the recorder to your computer as follows.

Note

When using Windows ME or Windows 98SE

- If you connect the recorder to the computer with the disc mode on the recorder set to “Hi-MD” (factory setting), and then insert a 60/74/80-minute standard disc, the operation mode of the disc may automatically change to Hi-MD mode even if you do not record anything.
- When you disconnect the USB cable, the message “Unsafe Removal of Device” appears in the computer display. This is not a problem. Merely click “OK” to make the message disappear.

Power (bus power) is supplied from the USB port of the computer so that the recorder can be used without power being supplied from the battery.

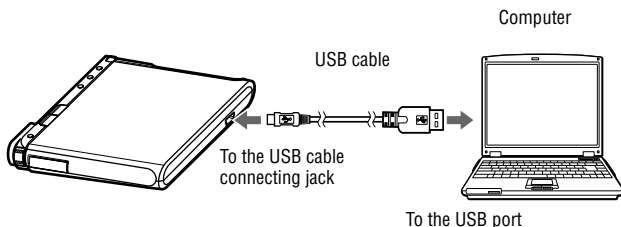

- 1 Insert a disc into the recorder.
- 2 Make sure the recorder is stopped and HOLD is released.
- 3 Connect the recorder to the computer through the USB cable.
- 4 Check the connections.

If all connections have been correctly made, the display window appears as follows.



“Hi-MD” or “MD” appears, depending on the operation mode.

When you unplug the USB cable from the computer

Be sure to remove the recorder as follows. If not, damage to the data may occur.

- 1 Make sure that the operation lamp on the recorder is not flashing rapidly.
- 2 Press **■** · CANCEL on the recorder.
Make sure that the operation lamp on the recorder is off.
“EJECT DISC OK” appears in the display.
Depending on the conditions, it may take some time until “EJECT DISC OK” appears in the display.
- 3 Unplug the USB cable from the computer.

When you remove the disc from the recorder

- 1 Follow steps 1 and 2 of “When you unplug the USB cable from the computer” above.
- 2 Remove the disc from the recorder.



This recorder supports Hi-Speed USB*.

* Compatible with USB 2.0 Specification.

Notes

- Make sure not to connect the USB cable while the recorder is operating. This may cause the recorder to malfunction or noise to be output.
- Depending on the connection, it may take some time before the recorder is recognized by the computer. If you operate the recorder or the computer before the recorder is recognized, “RECONNECT USB” appears in the display. If this happens, reconnect the USB cable.
- If the operation lamp flashes rapidly, do not disconnect the USB cable. This may cause the recorder to malfunction or the destruction of audio data.
- If you use the recorder connected to the computer, it is recommended that you insert a fully charged rechargeable battery as a precaution against power failures, disconnection of the USB cable or other unforeseen occurrences. We do not assure the results should there be a mis-operation, transfer failures, or destruction of audio data caused by unforeseen occurrences.
- If you disconnect the USB cable from the recorder and want to reconnect it, make sure to wait at least 2 seconds before connecting it again.
- Make sure to place the recorder at a stable, vibration-free place during recording.
- Make sure not to connect the recorder to your computer during recording or playing.
- The system may malfunction if your computer changes to system suspend, sleep, or hibernation mode while connecting to the recorder. Make sure to disable any changes to suspend, sleep, or hibernation mode.
- Make sure not to connect the recorder and the computer through a USB hub.
- When the recorder is connected to a computer, power (bus power) is supplied to the recorder through the computer’s USB port. If the computer (a laptop PC, for example) is operating on battery power, this connection may cause the computer’s battery to drain. It is thus recommended to use the computer with an AC power adaptor.
- We do not ensure trouble-free operation on all computers that satisfy the system requirements.

Using SonicStage

Importing audio data

Audio data from an audio CD can be recorded and stored to My Library of SonicStage. If you want to automatically obtain CD information (such as track or artist name), the computer has to be connected to the Internet. For details on recording or importing music from the Internet or from your computer's hard disc, refer to SonicStage Help.

Note

Only audio CDs with a  mark can be used with SonicStage. We do not guarantee normal operation in the case of the copy-controlled CDs.



1 Double-click ([SonicStage] icon) on the desktop.

SonicStage starts up.

2 Insert the audio CD that you want to record into the CD drive of your computer.

3 Point to ▼ of [▼ Music Source] and click [Import a CD].



4 Click .

The recording starts.

To stop recording.

Click .



- If you want to change the format, recording mode and bit rate for audio CD recording, click  before clicking  in step 4 and set the format and bit rate.
- If CD information could not be obtained automatically, click [CD Info] before clicking  in step 4. When you do this, your computer must be connected to the Internet.

Transferring audio data from your computer to the recorder

Audio data stored in My Library of SonicStage can be transferred to the recorder. Transferred audio data contains track information such as artist and album name.

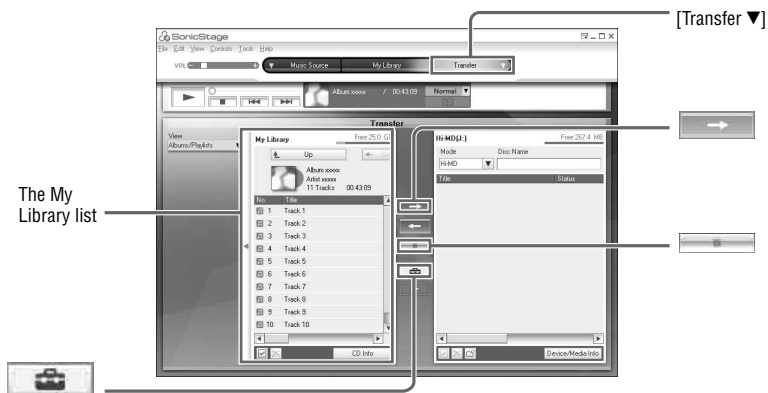

1 Insert a disc into the recorder and connect the recorder to your computer (☞ page 21).

2 Point to ▼ of [Transfer ▼] and click [Hi-MD] or [Net MD].

3 Click the tracks you want to transfer in the My Library list.

4 Click .

The operation lamp on the recorder lights up in red and transfer of the selected track starts.

To stop transferring

Click .



If you want to change the format and bit rate, click  before clicking  in step 4 and set the format and bit rate.

Note

Make sure not to disconnect the USB cable or take out the rechargeable battery while transferring audio data.

Transferring audio data from the recorder to your computer

Audio data that has been transferred from your computer and stored on an MD or recorded on this recorder or another MD component can be transferred to My Library of SonicStage on your computer.

Information such as album name or track name can be obtained from the Internet after audio data has been transferred. Refer to the SonicStage Help for details.

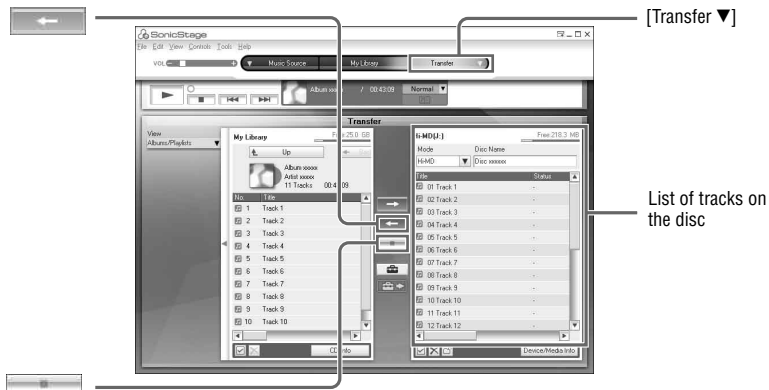

1 Insert a disc into the recorder and connect the recorder to your computer (page 21).

2 Point to ▼ of [Transfer ▼] and click [Hi-MD] or [Net MD].

3 In the list on the right side of the screen (Hi-MD or Net MD), click to select the tracks you want to transfer to your computer.

4 Click .

The transferring of the tracks selected in step 3 starts.

To stop transferring

Click .



When tracks recorded on MD components are included on a disc, a dialog box appears confirming whether to save those tracks in WAV format. To save the tracks as WAV format music files, select the check box next to "Save in WAV format when importing", click Browse button and specify a destination folder as necessary, and click the [OK] button.

Notes

- When a disc used in Hi-MD mode is inserted in the recorder and the record-protect tab of the disc is open, audio data cannot be transferred to the computer. Make sure that the record-protect tab of the disc is closed (Ⓔ page 76).
- Tracks transferred from the computer in “Net MD” mode or tracks purchased through EMD services and transferred to the recorder can be transferred only to the same computer from which they originally came from.
- When you transfer tracks recorded in LinearPCM on the recorder to a computer for editing (dividing (Ⓔ page 47) or combining (Ⓔ page 48)) in My Library, the editing may take a long time, depending on the length of the tracks and capabilities of your computer. This is due to limitations in the MiniDisc system. If you want to edit long tracks recorded in LinearPCM, we recommend that you do the editing on the recorder first, and then transfer the edited data to a computer afterwards.

Viewing SonicStage Help

SonicStage Help provides further details on how to use SonicStage.

Click [Help] – [SonicStage Help] while SonicStage is running.

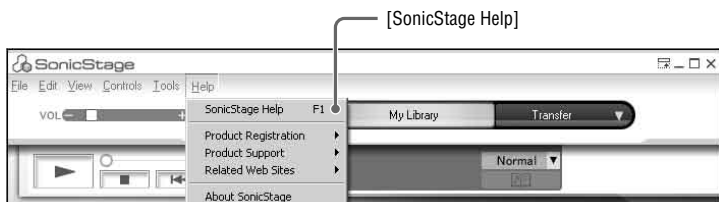

Using MD Simple Burner

MD Simple Burner allows you to record music tracks from an audio CD in the CD drive of your computer to the recorder without storing the data to the computer's hard disk.

There are two modes for recording from an audio CD: Simple mode (recording by the recorder operations) and Standard mode (recording by computer operations).

Note

Only audio CDs with a  mark can be used with MD Simple Burner. We do not guarantee normal operation in the case of the copy-controlled CDs.

Recording using the recorder operations (Simple mode)

1 Insert a disc into the recorder and connect the recorder to your computer ( page 21).

2 Insert the audio CD that you want to record into the CD drive of your computer.

3 Press and slide REC on the recorder.

The operation lamp on the recorder flashes in red and recording starts. All tracks on the CD are recorded as a new group. Make sure not to disconnect the USB cable until the recording ends.

To stop recording

Click  Abort on the computer display.

You can also stop recording by pressing  CANCEL on the recorder.



Before starting recording, you can set the following settings by right-clicking the  MD Simple Burner icon in the task tray on the computer display.

- You can select the recording mode by selecting [recording mode].
 - [Net MD]: [LP2] or [LP4]
 - [Hi-MD]: [PCM], [Hi-SP], [Hi-LP], or [48kbps]
- You can record the first track only by selecting [Recording settings] – [Record 1st Track Only].
- You can select the setting when the CDDb has more than one item of information by selecting [CDDb(r)]
 - [Multiple Matches].
 - [User Selection]: A selection window is displayed
 - [No Resolve]: No CD information is downloaded
 - [First Choice]: The first item is downloaded

Note

You cannot record in simple mode while the MD Simple Burner in standard mode or OpenMG software (SonicStage, OpenMG Jukebox, etc.) is active.

Recording by computer operations (Standard mode)

1 Insert a disc into the recorder and connect the recorder to your computer (☞ page 21).

2 Double-click  ([MD Simple Burner] icon) on the desktop.
MD Simple Burner starts up.

3 Insert the audio CD that you want to record into the CD drive of your computer.

You can operate MD Simple Burner from the following two display windows.

The window for recording all tracks on the CD

[REC/STOP]

To start recording all tracks on the CD as a new group, click here.
To stop recording, click [STOP].

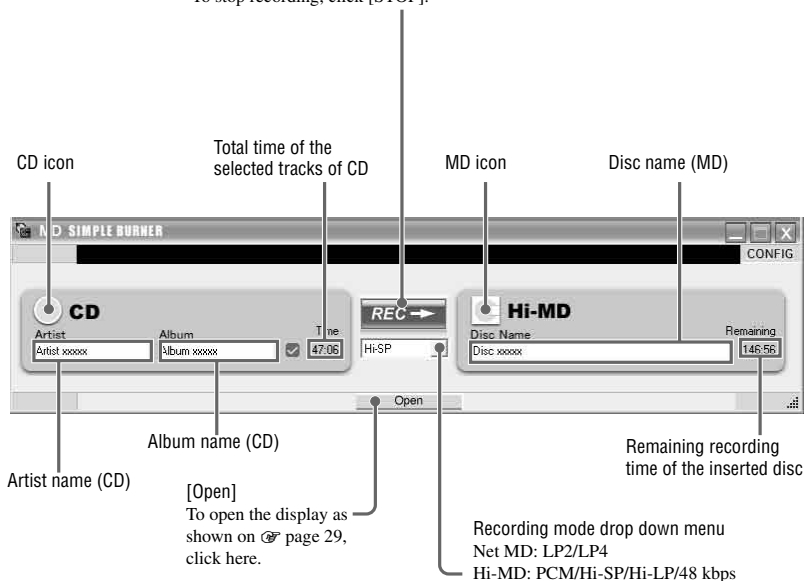

The window for recording selected tracks from an audio CD

[CONFIG]

Click here to do the following:

- Set the CD-ROM drive
- View version information for MD Simple Burner
- Confirm CD information registered in the CDDB

Track information (CD)

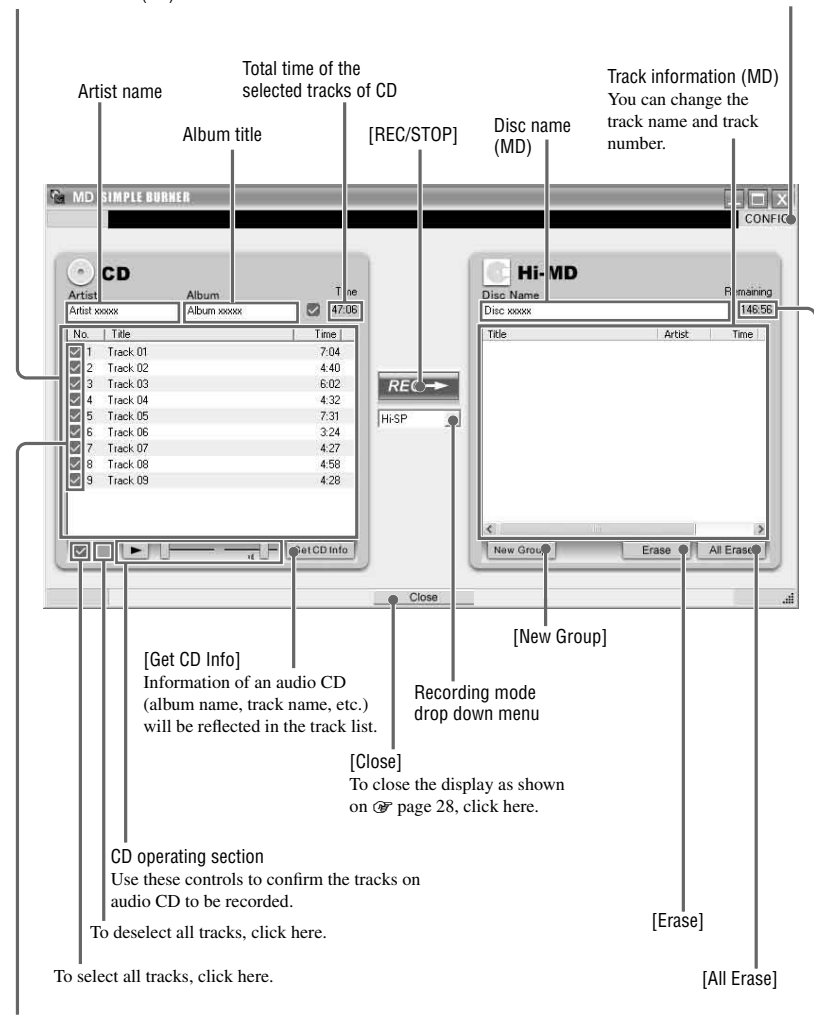

Artist name

Total time of the selected tracks of CD

Album title

[REC/STOP]

Disc name (MD)

Track information (MD)
You can change the track name and track number.

[Get CD Info]

Information of an audio CD (album name, track name, etc.) will be reflected in the track list.

[Close]

To close the display as shown on page 28, click here.

Recording mode drop down menu

[New Group]

[Erase]

[All Erase]

CD operating section

Use these controls to confirm the tracks on audio CD to be recorded.

To deselect all tracks, click here.

To select all tracks, click here.

Check boxes

Check the box of the tracks that you want to record.

Remaining time of the inserted disc

Storing non-audio data to a disc

If you connect the recorder to a computer with a disc in Hi-MD mode inserted, the disc is recognized as storage media by the Windows Explorer, allowing you to store non-audio data such as text data or image data.

For the storage space for each disc, refer to “The storage space for each disc (formatted with the recorder/SonicStage)” below.

1 Insert a disc in Hi-MD mode into the recorder and connect the recorder to the computer (☞ page 21).

The recorder is recognized as an external device and can be viewed on the Windows Explorer. You can use the recorder in the same way as other devices.

Notes

- When the SonicStage software is active, the recorder is not recognized as a data storage device.
- If you format a disc on the computer, make sure to format the disc using the SonicStage software.
- Make sure not to delete the file management folder and file (HMDHIFI folder and HI-MD.IND file) on the Windows Explorer.

The storage space for each disc (formatted with the recorder/SonicStage)

The storage space is varied depending on disc type.

	1GB Hi-MD disc	80-minute standard disc	74-minute standard disc	60-minute standard disc
Total size	964 MB	291 MB	270 MB	219 MB
Disc management space *	1.65 MB	1.65 MB	1.65 MB	1.65 MB
Free space	963 MB	290 MB	268 MB	217 MB

* This is space that is used for managing the files on the disc. The size of the disc management space changes according to the operating conditions of your computer and other factors. Therefore, the actual space available for use may be lower than that displayed by Windows Explorer.

Recording on a disc

This section explains the procedure for recording from a stereo microphone. Make sure that the rechargeable battery is sufficiently charged before recording. For details on the optional stereo microphone, see “Optional accessories” (page 11).

1 Connect the stereo microphone to MIC (PLUG IN POWER).

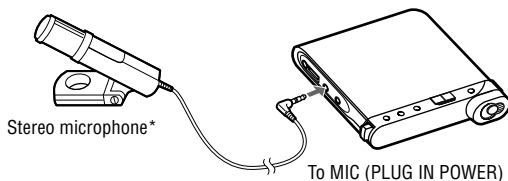

* The shape of the stereo microphone supplied with the MZ-M200 is different.

2 Press OPEN to open the lid (1). Insert a disc in the direction of the arrow (2), and close the lid.

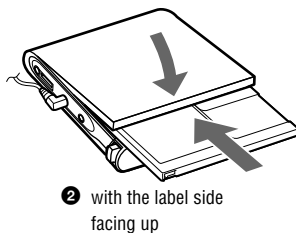
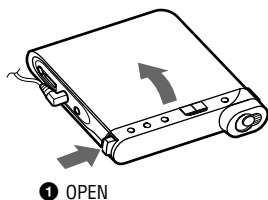

3 Confirm the operation mode.

This recorder has two operation modes, “Hi-MD mode” and “MD mode”. The operation mode is automatically recognized whenever the disc is inserted. After you insert a disc, check the operation mode on the display window of the recorder. You can also check the recording mode setting (“REC Mode” in the menu). Change the recording mode if necessary (☞ page 50).

“Hi-MD” lights up when the operation mode is Hi-MD mode and
“MD” lights up when the operation mode is MD mode.

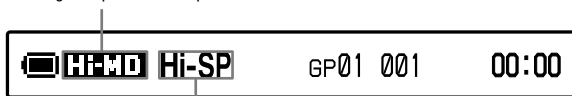

Recording mode

- When using a 1GB Hi-MD disc, the operation mode will only be Hi-MD.
- When using a standard disc (60/74/80 minutes), the operation mode can be set as follows.

Disc condition	Operation mode
Blank disc	The mode set for the “Disc Mode”* in the menu. Set “Disc Mode” to “Hi-MD” or “MD”.
The disc contains material recorded in Hi-MD mode	Hi-MD
The disc contains material recorded in MD mode	MD

* Refer to ☞ page 59 for “Disc Mode” in the menu.

4 Press DISPLAY/MENU repeatedly and confirm the recording level setting (REC property).

The indication displayed will vary according to the “REC Level” (☞ page 50) setting in the menu.

- “REC Auto”: “REC Level” is set to “REC (AGC)”. The recorder adjusts the recording level automatically.
- “REC XX”: “REC Level” is set to “Manual”. The recording level that was last set appears. You can also check the microphone recording setting (“MIC Sens” or “MIC AGC” in the menu) at the same time. Change the setting if necessary (☞ page 50).

“REC Auto” appears when “REC Level” is set to “Auto (AGC)”.

Microphone sensitivity (“MIC Sens”)

- “High”: High sensitivity (“Sens High”)
- “Low”: Low sensitivity (“Sens Low”)



Automatic microphone recording level adjustment mode (“MIC AGC”)

- (none): Standard mode (“Standard”)
- “”: Music mode (“For Music”)

5 Confirm that the operation lamp is off (❶), and then press and slide REC on the recorder (❷).

The operation lamp lights up in red and recording starts.

If you insert a previously recorded disc, the recording starts after the existing contents.

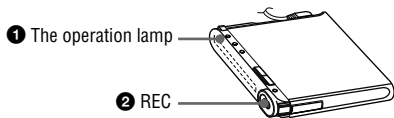

Basic recording operations

To	Press
Stop	Press ■ · CANCEL. (The operation lamp disappears.)
Pause	Press ■■*. (The operation lamp flashes in red.) Press ■■ again to resume recording.
Remove the disc	Press ■ · CANCEL and open the lid. (The lid does not open until "SystemFILE WRITING" disappears from the display and the operation lamp stops flashing.)
Adding track marks	Press T MARK. (The operation lamp disappears for a moment.)

* A track mark is added at the point where you press ■■ again to resume recording while pausing; thus the remainder of the track will be counted as a new track.

- Make sure to place the recorder at a stable, vibration-free place during recording.
- If you start recording before the operation lamp turns off, the first few seconds of the material may not be recorded. Verify on the recorder that the operation lamp is off before you start recording.
- The recorder automatically switches input in the following order; optical input, microphone input, and analog input. You cannot record through the microphone while an optical cable is connected to the LINE IN (OPT) jack.
- The microphone may pick up the operating sound of the recorder itself. Use the microphone away from the recorder in such cases. Please note that the sound of recorder operations may be picked up if the microphone that you use has a short connector.
- Only the left-channel sound is recorded when a monaural microphone is used.
- Make sure not to connect the USB cable while the recorder is operating. This may cause the recorder to malfunction or noise to be output.
- Do not touch the microphone and its plug while recording with the recorder connected to a wall outlet. Doing so may introduce noise in the recording.
- Do not move or jog the recorder or disconnect the power source while recording, or while “DATA SAVE” or “SystemFILE WRITING” (“DATA SAVE” or “SYSTEM WRITE” on the remote) is displayed. If you do, the data recorded up to that point may not be recorded to the disc, or data on the disc may be damaged.
- Recording cannot be done when the disc does not have enough space for recording.
- If the power supply is disrupted (i.e. the battery is removed or becomes exhausted or the AC power adaptor is disconnected) during a recording or editing operation, or while “DATA SAVE” or “SystemFILE WRITING” (“DATA SAVE” or “SYSTEM WRITE” on the remote) is displayed, then it will not be possible to open the lid until power is restored.



- When using a plug-in power-type microphone, the microphone can be operated even when its power switch is turned off since power is supplied from the recorder itself.
- You can select the mode for adjusting the microphone sensitivity or automatic recording level adjustment mode to suit the sound source (Ⓞ page 50).
- The recorder is factory set to make a new group whenever recording is done. If you do not want to make a group, set “Group REC” to “Off” (Ⓞ page 51).
- To start recording from a specific point on the disc, pause the recorder at the desired point, and then start recording from that point.
- You can monitor the sound during recording. Changing the volume level will not affect the recording level.
- Once the clock is set, tracks are automatically stamped with the time and date of recording (Ⓞ page 61).
- It is preferable to use the recorder on house current when using the recorder for a long time, especially when recording.

Displayed items during recording

Display window on the recorder

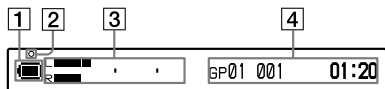

- 1 Battery indication (☞ page 15)
- 2 Operation lamp
 - During recording: lights up (red)
 - During recording pause: flashes (red)
 - When the remaining recording time on the disc is less than 3 minutes: flashes slowly (red)
 - When recording with the microphone: flashes according to the sound level (Voice mirror) (red)
- 3 Information display 1
 - Level meter (graphic above)
 - Operation mode (example: Hi-MD)
 - Recording mode (example: Hi-SP)
 - Synchro-recording indication (SYNC)
- 4 Information display 2
Refer to "To change the display on the recorder" (☞ next).

To change the display on the recorder

Press DISPLAY/MENU repeatedly. Each time you press the button, the display changes cyclically as follows. (Recording level meter appears on the information display 1 (3) on the left column of this page) while recording.)

While recording/while the recorder is stopped

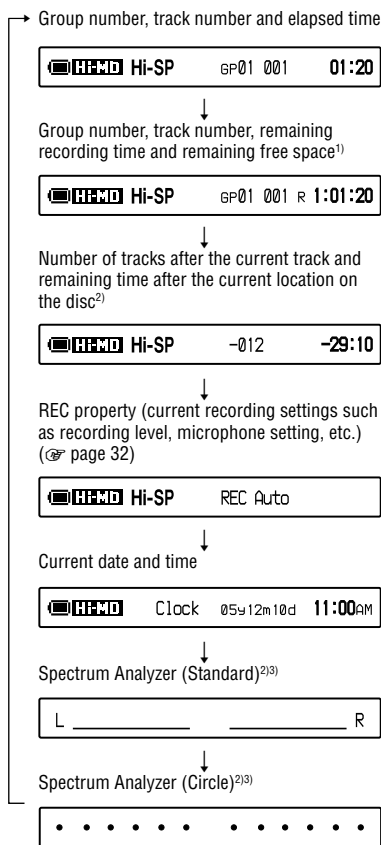

¹⁾ Remaining free space appears only when the disc is used in Hi-MD mode and the recorder is stopped.

²⁾ Appears only when the recorder is stopped.

³⁾ Shows the level of each of the following frequencies for both the L-channel and R-channel: 100 Hz, 250 Hz, 630 Hz, 1.6 kHz, 4 kHz, 10 kHz.

Display window on the remote

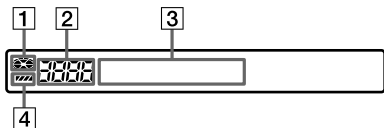

- 1 Disc indication
- 2 Track number/Total number of tracks in a disc
- 3 Information display
Refer to “To change the display on the remote” (Ⓞ next).
- 4 Battery indication

To change the display on the remote

Press DISPLAY repeatedly. Each time you press the button, the display changes cyclically as follows.

While recording/while the recorder is stopped

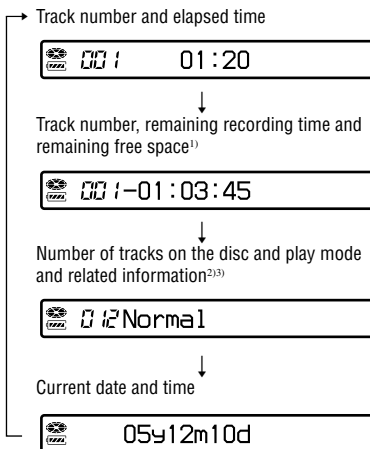

¹⁾ Remaining free space appears only when the disc is used in Hi-MD mode and the recorder is stopped.

²⁾ Appears only when the recorder is stopped

³⁾ The items that are displayed differ according to the selected play mode. (Example: When the play mode is set to “Group”, “Group” and “ : Group name” appear.)

Notes

- Depending on the group settings, the operating conditions, and the disc settings, you may not be able to select certain indications or the indications may appear differently.
- When a disc used in Hi-MD mode is inserted in the recorder, the free space will show as “2.0MB” when the remaining recording time becomes “R 00:00”(“-00:00” on the remote). This is a system limitation, “2.0MB” being the capacity of the reserve domain.

Recording from externally connected component

You can make digital recordings using an optical cable connected to a CD player, digital TV, or other digital equipment. Make sure to use an optical cable for this procedure.

1 Connect the AC power cord and the USB cable to the AC power adaptor.

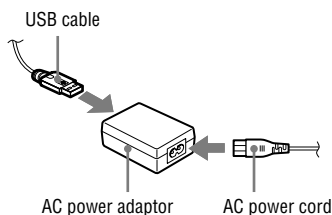

2 Connect the other end of the USB cable to the recorder and the AC power cord to a wall outlet.

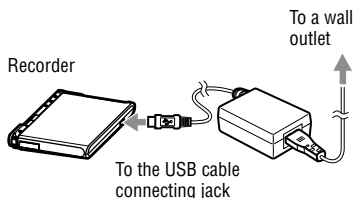

3 Connect the optical cable to the recorder and an external component.

For details on the optional optical cable, see “Optional accessories” (☞ page 11).

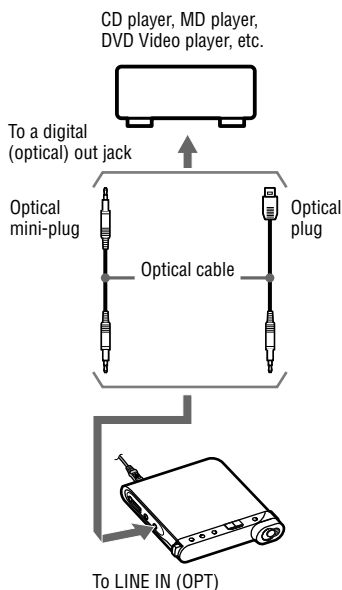

4 Press OPEN to open the lid and insert a disc in the recorder.

5 Confirm the settings of the operation mode and the recording level.

Refer to steps 3 and 4 of “Recording on a disc” (☞ page 32).

6 Pause the sound source to be recorded and confirm on the recorder that the operation lamp is off.

7 Press and slide REC on the recorder and play the sound source you want to record.

Track marks are automatically added at the same point as the sound source.

When recording in analog

You can record from equipment with analog output, such as a cassette recorder, radio, or TV.

- 1** Using an optional connecting cord (RK-G129, etc.), connect the LINE IN (OPT) jack of the recorder to a LINE OUT jack of the radio cassette, TV or other external component.

Connect the end of the connecting cord with the ferrite core to the recorder.

- 2** Press and slide REC.
- 3** Start playing the source.



- The recorder is factory set to make a new group whenever recording is done. If you do not want to make a group, set “Group REC” to “Off” (ⓘ page 51).
- For details on the optional connecting cord, see “Optional accessories” (ⓘ page 11).

Playing a disc

- 1** Press OPEN to open the lid (❶). Insert a disc in the direction of the arrow (❷), and close the lid.

Connect the earphones with the remote to the recorder beforehand.

Earphones with
the remote

To the /LINE OUT
jack

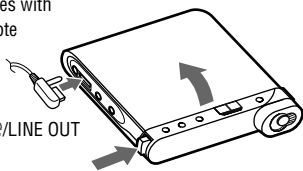

❶ OPEN

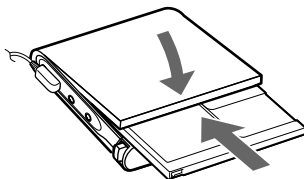

❷ with the label side
facing up

- 2** Press the jog lever (▶/ENT) to play (❶), and adjust the volume by pressing VOL +/- (❷).

The volume will be shown in the display.

❷ VOL +/-

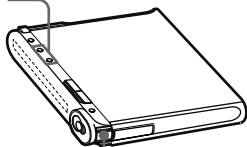

❶ Jog lever (▶/ENT)

On the remote

Press the jog lever (▶/ENT). Playback starts. You can adjust the volume by turning the VOL +/- control.

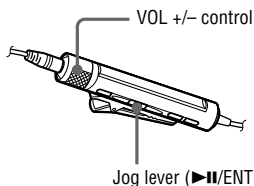

Basic playback operations

To	Operation on the recorder (Operation on the remote is in parentheses)	
Play	Play from a point where you stopped the recorder previously	Press the jog lever (▶/ENT). Playback starts from the point you last stopped playing. (Press the jog lever (▶ /ENT).)
	Play from the first track in a disc	From stop, press and hold the jog lever (▶/ENT) until playback starts. (Press and hold the jog lever (▶ /ENT).)
Stop	Pause/Resume play after pausing	Press . (Press the jog lever (▶ /ENT).)
	Stop playback	Press ■ · CANCEL. (Press ■.)
Search	Find the beginning of the current track or previous tracks	Move the jog lever toward FR once, or move the jog lever toward FR repeatedly until you reach the beginning of the desired track. (Move the jog lever toward ◀◀ once, or move the jog lever toward ◀◀ repeatedly.)
	Find the beginning of the next track	Move the jog lever toward FF once. (Move the jog lever toward ▶▶ once.)
	Go backwards or forward	During playback or pause, move and hold the jog lever toward FR/FF. (Move and hold the jog lever toward ◀◀/▶▶.)
	Cue to the next or previous group while playing track in a group* (Group skip)	Press □ +/- on the remote repeatedly.
Remove the disc	Press ■ · CANCEL and open the lid**. (Press ■ and open the lid.)	

* Cues to the beginning of every 10th track during playback of the disc with no group settings.

** Once you open the lid, the point to start play will change to the beginning of the first track.

Notes

- Make sure not to connect the USB cable while the recorder is operating. This may cause the recorder to malfunction or noise to be output.
- The playback sound may skip if:
 - the recorder is subjected to strong, repeated shocks.
 - a dirty or scratched disc is played.

When using a disc in Hi-MD mode, the sound may drop out for a maximum of about 12 seconds.

Displayed items during playback

Display window on the recorder

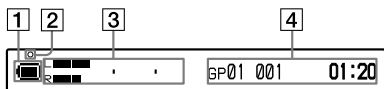

- 1 Battery indication (☞ page 15)
- 2 Operation lamp
After performing an editing operation during play or play pause: flashes slowly (red)
- 3 Information display 1
Level meter (graphic above)
- 4 Information display 2
Refer to "To change the display on the recorder" (☞ next).

To change the display on the recorder

Press DISPLAY/MENU repeatedly. Each time you press the button, the display changes cyclically as follows.

While playing

→ Group number, track number and elapsed time

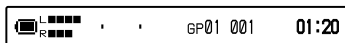

↓
Group number, track number and remaining time of the current track

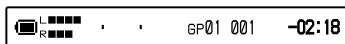

↓
Number of tracks after the current track and remaining time after the current location on the disc

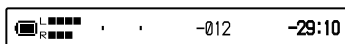

↓
Recording date and time*

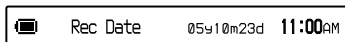

↓
Spectrum Analyzer (Standard)**

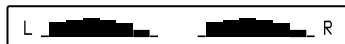

↓
Spectrum Analyzer (Circle)**



* Recording date and time are displayed if they have been recorded on the track.

** Shows the level of each of the following frequencies for both the L-channel and R-channel: 100 Hz, 250 Hz, 630 Hz, 1.6 kHz, 4 kHz, 10 kHz.

Display window on the remote

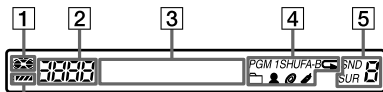

- 1 Disc indication
- 2 Track number/Total number of tracks in a disc
- 3 Information display
Refer to “To change the display on the remote” (☞ next).
- 4 Play mode and repeat mode information
(☞ pages 43, 44)
- 5 Sound setting (☞ page 45)
- 6 Battery indication

To change the display on the remote

Press DISPLAY repeatedly. Each time you press the button, the display changes cyclically as follows.

While playing

→ Track number and elapsed time

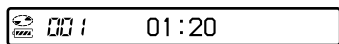

↓
Track number and remaining time of the current track

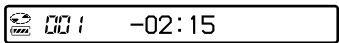

↓
Track number and track name

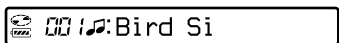

↓
Track number and artist name (Hi-MD) / Group name (MD)

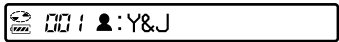

Track number and album name (Hi-MD) / Disc name (MD)

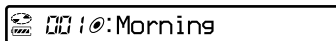

↓
Number of tracks in the disc, play mode and related information¹⁾

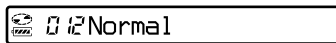

↓
Track number, recording date and time²⁾

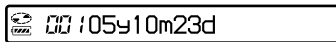

↓
Track number and audio format information³⁾

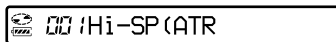

- ¹⁾ The items that are displayed differ according to the selected play mode. (Example: When the play mode is set to “Group”, “Group” and “Group name” appear.)
- ²⁾ Recording date and time are displayed if they have been recorded on the track.
- ³⁾ Recording mode, codec and bitrate information appear for discs used in Hi-MD mode, and recording mode information appears for discs used in MD mode.

Notes

- Depending on the group settings, the operating conditions, and the disc settings, you may not be able to select certain indications or the indications may appear differently.
- When playing a VBR (Variable Bit Rate) MP3 audio track, the displayed bit rate may differ from the bit rate displayed in the SonicStage software.
- When the Virtual-Surround, 6-Band Equalizer and Dynamic Normalizer are active, their setting conditions are displayed in the Spectrum Analyzer.

Selecting the play mode

This function can be set on the remote only.

Playing tracks in the selected play mode

1 Press **P MODE/↵** for 2 seconds or more.

2 Move the jog lever toward **◀◀/▶▶** to select the desired play mode, and then press the jog lever.

When you move the jog lever, **A** changes, and when you press the jog lever, **B** appears in the display.

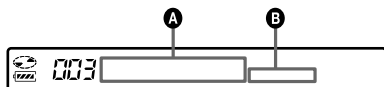

Display A/B	Play mode
Normal/—	All tracks after the selected track are played.
Group/📁	Tracks in a specified group are played.
Artist/👤 *	Tracks by a specified artist are played.
Album/🎵 *	Tracks in a specified album are played.
Bookmark/📌	Bookmarked tracks are played.

*Appears only for discs used in Hi-MD mode.

3 • When you select “Normal”

Repeat the procedure in step 2 to select the desired track.

The selected track starts playing.

• When you select “Group”, “Artist”, or “Album”

Repeat the procedure in step 2 to select the desired group, artist, or album, and then repeat the procedure in step 2 again to select the desired track.

The selected track starts playing.

• When you select “Bookmark”

Refer to “Listening to selected tracks only (Bookmark Play)” (📌 this page).

Listening to selected tracks only (Bookmark Play)

You can bookmark tracks on a disc and play them only. The sequence of bookmarked tracks cannot be changed.

1 While playing the track you want to bookmark, press the jog lever for 2 seconds or more.

“ON” appears and “📌” flashes slowly in the display.

2 Repeat step 1 to bookmark the other tracks.

3 Do step 1 and select “Bookmark” in step 2 of “Playing tracks in the selected play mode” (📌 this page).

4 Move the jog lever toward **◀◀/▶▶** to select a track, and then press the jog lever to enter.

The recorder plays from the selected bookmarked track to the last bookmarked track.

To erase bookmarks





While playing the track for which you want to erase the bookmark, press the jog lever for 2 seconds or more.

Playing tracks repeatedly (Repeat Play)

By specifying Repeat play, you can listen to tracks selected in Play mode in various ways.

1 Press P MODE/ repeatedly to select the desired repeat mode.

Each time you press the button, the display changes as follows.

Display	Repeat mode
	All tracks repeat (All tracks on the disc are played repeatedly.)
1 	Single-track repeat (The selected track is played repeatedly.)
SHUF 	Shuffle repeat (All tracks on the disc are played in random order repeatedly.)
A- (A-B 	A-B Repeat play (Tracks between the selected points A and B are played repeatedly.)

Listening to a section of a track repeatedly

(A-B Repeat)

You can listen to a specific section within a track repeatedly by selecting the starting point A, and ending point B. Make sure that points A and B are within the same track.

1 While playing, press P MODE/ repeatedly until "A-" appears in the display.

"A" (starting point) flashes in the display.

2 Press the jog lever at the starting point (A).

Point "A" lights on and "B" flashes in the display.



3 Press the jog lever at the ending point (B).

"A-B" and "



You can reset points A and B by moving the jog lever toward  during A-B Repeat play.

To cancel Repeat Play

Press P MODE/ repeatedly until  disappears from the display.

Adjusting the sound

The following three effect can be selected.

- V-SUR (Virtual-Surround VPT Acoustic Engine):
Provides 4 kinds of virtual surround conditions.
- 6-BAND EQUALIZER:
Provides 6 different sound qualities.
- DYNAMIC NORMALIZER:
Normalizes the sound level automatically.

This function can be set on the remote only.

Varying the virtual sound to create different acoustics (Virtual-Surround)

1 While playing, press SOUND repeatedly until “SUR” appears in the display.

2 Press SOUND for 2 seconds or more.

3 Move the jog lever toward ◀◀▶▶ to select the surround mode.

Each time you move the jog lever, **A** and **B** changes as follows.

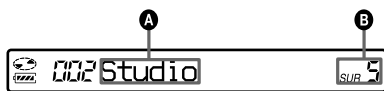

A	B
Studio	SUR S
Live	SUR L
Club	SUR C
Arena	SUR A

4 Press the jog lever to enter the selection.

To cancel the setting

Press SOUND repeatedly until “Normal” appears in the display.

Selecting the sound quality (6-Band Equalizer)

1 While playing, press SOUND repeatedly until “SND” appears in the display.

2 Press SOUND for 2 seconds or more.

3 Move the jog lever toward ◀◀▶▶ to select the sound mode.

Each time you move the jog lever, **A** and **B** changes as follows.



Level of each frequency appears alternately.
(100 Hz, 250 Hz, 630 Hz, 1.6 kHz, 4 kHz, 10 kHz)

A	B
Heavy	SND H
Pops	SND P
Jazz	SND J
Unique	SND U
Custom 1	SND 1
Custom 2	SND 2

4 Press the jog lever to enter the selection.

To cancel the setting

Press SOUND repeatedly until “Normal” appears in the display.

Customizing sound quality

You can customize the sound and store the results in “Custom1” and “Custom2”.

- 1 Do steps 1 to 3 of “Selecting the sound quality (6-Band Equalizer)” (page 45), and select “Custom1” or “Custom2”.
- 2 Press the jog lever.
- 3 Move the jog lever toward ◀▶/▶▶ repeatedly to select the frequency range.



Frequency range (100 Hz)
There are six frequency ranges.
100 Hz, 250 Hz, 630 Hz, 1.6 kHz, 4 kHz, 10 kHz

- 4 Turn the VOL +/- control repeatedly to select the sound level.

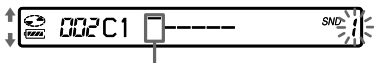

Level (+10 dB)

You can select from among seven levels.
-10 dB, -6 dB, -3 dB, 0 dB, +3 dB, +6 dB, +10 dB

- 5 Repeat steps 3 and 4 to make adjustments for the remaining frequency ranges.
- 6 Press the jog lever to enter the selection.

Normalizing the playback sound level automatically (Dynamic Normalizer)

This function automatically normalizes the sound level of the recorded material for comfortable listening during playback.

- 1 While playing, press **SOUND** repeatedly until “D-Normal” appears in the display.

“d” appears at **A**.



- 2 Turn the VOL +/- control to adjust the volume.



- Since this function automatically balances the sound level, it minimizes troublesome volume adjustments, especially for discs containing tracks with very different volume levels.
- This function allows you to hear low-volume sounds in places where the surrounding noise is loud without having to turn up the volume too high.

To cancel the setting

Press **SOUND** repeatedly until “Normal” appears in the display.

Dividing a track (Divide)

You can divide a track with a track mark while playing, creating a new track from the part following the track mark. This function can be set on the recorder only.

Note

You cannot divide a track if:

- the track has been transferred from a computer.
- the track has been recorded in Hi-MD mode using the MD Simple Burner software.
- the dividing point is at the beginning or end of the track.
- the division would cause the total number of tracks on the disc to exceed the maximum allowed (2,047 tracks for a disc used in Hi-MD mode or 254 tracks for a disc used in MD mode).

- 1 While playing or pausing, press T MARK at the point you want to mark.

Adjusting the dividing point before dividing a track (Divide Rehearsal)

You can make fine adjustments to the track mark position before making the actual division.

- 1 While playing or pausing, press T MARK for 2 seconds or more.

Four seconds of the track from the point T MARK is pressed is played back repeatedly.

The point T MARK is pressed.

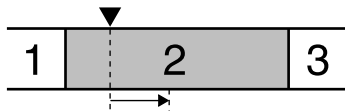

Four seconds of the track plays back repeatedly.

- 2 Move the jog lever toward FF/FR to adjust the point to divide.

Moving the jog lever moves the dividing point forward or backwards. The dividing point can be moved up to a maximum of 8 seconds forward or backwards from the point T MARK was pressed in step 1.

The point T MARK is pressed in step 1.

The dividing point shifts a maximum of 8 seconds forward or backwards.

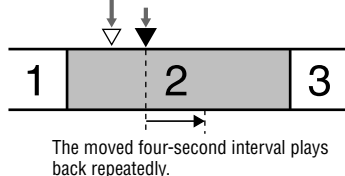

The moved four-second interval plays back repeatedly.

- 3 Press the jog lever to enter the dividing point.

“MARK ON” appears in the display and the track is divided.



You can use the Speed Control function (Ⓢ page 53) during the Divide Rehearsal function. This allows you to reduce the playback speed to carry out the division more accurately.

Note

It is recommended that you use the recorder to divide long tracks recorded in LinearPCM. Transferring such tracks and dividing them on the computer may require extremely long time.

Combining tracks (Combine)

You can erase a track mark to combine the tracks before and after the track mark. This function can be set on the recorder only.

Note

You cannot combine tracks if:

- one of the two tracks or the both tracks have been transferred from the computer.
- one of the two tracks or the both tracks have been recorded in Hi-MD mode using the MD Simple Burner software.
- the tracks are recorded in different recording mode.

1 While playing the track with the track mark you want to erase, press II to pause.

2 Find the track mark by moving the jog lever toward FR slightly.

For example, to erase the third track mark, find the beginning of the third track. “00:00” appears in the display. “MARK” appears in the display for a few seconds.

3 Press T MARK to erase the mark.

“MARK OFF” appears in the display. The track mark is erased and the two tracks are combined.



When a track mark is erased when you combine two tracks, the title and the recording date of the second track changes to those of the first track.

Notes

- When you erase a track mark between the two consecutive tracks that are assigned into different groups, the second track is re-assigned into the group containing the first track. In addition, if you combine a track that is assigned to a group with a track that is not assigned to a group (two consecutive tracks), the second track takes the same registration setting as the first track.
- It is recommended that you use the recorder to combine long tracks recorded in LinearPCM. Transferring such tracks and combining them on the computer may require extremely long time.

Using the Menu

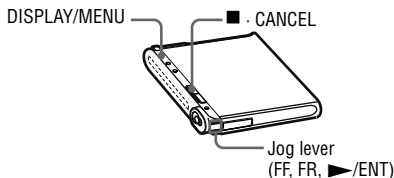

- 1 Press DISPLAY/MENU for 2 seconds or more.

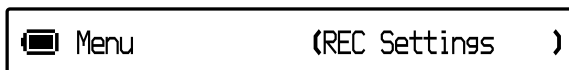

- 2 Move the jog lever toward FF/FR repeatedly to select the item.

- 3 Press the jog lever (▶/ENT).

- 4 Repeat steps 2 and 3.
The setting will be entered.

On the remote

Some menu items for playback and editing can also be set on the remote.

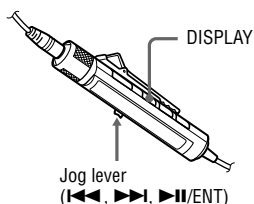

- 1 Press DISPLAY for 2 seconds or more.
- 2 Move the jog lever toward ◀◀/▶▶ repeatedly to select the item.
- 3 Press the jog lever (▶▶/ENT).
- 4 Repeat steps 2 and 3.

To return the preceding setting

Press ■ · CANCEL (■ on the remote).

To stop operation



Press ■ · CANCEL (■ on the remote) for 2 seconds or more.

Menus for recording

Select “REC Settings” in the menu. Recording-related menus can be set only on the recorder.

Items	Options (●: Default settings)	
REC Mode	PCM ¹⁾	Recording time is approximately 28 minutes on 80-minute standard disc, and approximately 1 hour and 34 minutes on 1 GB Hi-MD disc (LinearPCM recording).
	Hi-SP ● ¹⁾	Recording time is approximately 2 hours and 20 minutes on 80-minute standard disc, and approximately 7 hours and 55 minutes on 1 GB Hi-MD disc.
	Hi-LP ¹⁾	Recording time is approximately 10 hours and 10 minutes on 80-minute standard disc, and approximately 34 hours on 1 GB Hi-MD disc.
	SP ● ²⁾	Recording time is approximately 1 hour and 20 minutes on 80-minute standard disc.
	LP2 ²⁾³⁾	Recording time is approximately 2 hours and 40 minutes on 80-minute standard disc.
	LP4 ²⁾³⁾	Recording time is approximately 5 hours and 20 minutes on 80-minute standard disc.
REC Level	Auto (AGC) ●	The recorder adjusts the recording level automatically.
	Manual	You can adjust the recording level manually (☞ page 52).
MIC AGC	Standard ●	Microphone recording level adjustment mode for recording sources such as conversations. The recording level is automatically adjusted to suppress distortion and produce clear recordings. Can be selected while “REC Level” is set to “Auto (AGC)”.
	For Music	Microphone recording level adjustment mode for recording sources such as music concerts or jam sessions. The recording level is automatically adjusted to obtain greater distortion suppression and natural volume transitions close to those in the original sound. Can be selected while “REC Level” is set to “Auto (AGC)”.
MIC Sens	Sens High ●	Microphone sensitivity for recording sounds of normal volume, such as a conversation.
	Sens Low	Microphone sensitivity for recording loud or close-range sounds, such as a music concert.
Time Mark	Off ●	Track marks are automatically added as they appear in the sound source.
	On	Time 01 min - Time 60 min Track marks are added at specified intervals. This interval can be set in 1-minute units up to 60 minutes.

Items	Options (●: Default settings)	
Group REC	Off	The recorder does not make a new group at the start of recording.
	On ●	The recorder makes a new group at the start of recording.
SYNC REC	Off ●	Normal recording is performed.
	On	Synchro-recording is performed (recording starts and stops in sync with the sound source when digital recording).

¹⁾ Appears only for discs used in Hi-MD mode. Audio components marked with the  or  logo mark support “PCM”, “Hi-SP” and “Hi-LP” recording modes.

²⁾ Appears only for discs used in MD mode.

³⁾ Audio components marked with the  or  logo mark support “LP2” and “LP4” recording modes.

Setting for microphone recording (“MIC AGC”)



When the sound being recorded (e.g., music) is low in volume and the surrounding sound is loud (audience noise, applause, etc.), the “Standard” setting in the “MIC AGC” menu is more suitable.

Note

You cannot set the “MIC AGC” setting if the recorder is set to adjust the recording level manually (while “REC Level” in the menu is set to “Manual”) (☞ page 52).

Setting for adding track marks (“Time Mark”)

Using Time Mark to add track marks while recording

- When the elapsed recording time exceeds the time interval for Time Mark:
The recorder adds track marks at the point you set the time interval and from that point the recorder adds a track mark whenever the time interval has elapsed.

Example: 8 minutes of recording has been completed when the Time Mark time interval is set to 5 minutes.

A track mark will be added at the 8-minute point (after the start of recording) and after each 5-minute interval thereafter.

- When the time interval set for Time Mark exceeds the elapsed recording time:
The recorder adds track marks when the set Time Mark time interval has elapsed.
Example: Three minutes of recording has been completed when the Time Mark time interval is set to 5 minutes.
A track mark will be added at the 5-minute point (after the start of recording) and after each 5-minute interval thereafter.



“T” appears before the time display for track marks added with the “Time Mark” setting.

Notes

- “Time Mark” can be set only when recording through the analog input connector or a microphone.
- If while recording you add a track mark by pressing T MARK or **II** (pause), etc., from that point onward the recorder will begin automatically adding track marks at regular intervals, as set by “Time Mark”.
- “Time Mark” is canceled when you connect a digital optical cable to the recorder.

Setting for synchro-recording (“SYNC REC”)



When there is no sound from the connected player for about 3 seconds during synchro-recording, the recorder goes into the standby mode automatically. When the sound comes from the player again, the recorder resumes synchro-recording. If the recorder is kept in the standby mode for 5 minutes or longer, the recorder stops automatically.

Notes

- The pause function cannot be turned on or off manually during synchro-recording.
- Do not switch the “SYNC REC” setting while recording. Recording may not be done properly.
- Even when there is no sound on the sound source, there may be cases when recording does not pause automatically during synchro-recording due to the noise level emitted from the sound source.
- If a silent portion is encountered for approximately 2 seconds during synchro-recording from a sound source other than a CD or an MD, a new track mark is automatically added at the point where the silent portion ends.

Adjusting the recording level manually

If necessary, you can set the recording level manually during both analog and digital recording.

1 While the recorder is stopped or in recording pause, enter the menu (ⓘ page 49) and select “REC Settings” – “REC Level” – “Manual”.

2 Press and slide REC while pressing **II.**

The operation lamp flashes in red and the recorder stands by for recording.

3 Play the source.

4 While observing the level meter in the display, adjust the recording level by moving the jog lever toward FF/FR.

Set the level so that the level meter lights up at around “-12 dB”. If high sound input causes the “OVER” segment (“”) to light up, lower the recording level.



5 Press **II again to start recording.**

If your source is an externally connected component, play the source to the beginning of the material to be recorded, and then start recording.



- You can adjust the recording level during recording by moving the jog lever.
- Even after recording ends, the recording level stays the same until it is adjusted again.

Notes

- You cannot adjust the left and right channel levels separately.
- To adjust the recording level manually when synchro-recording, do steps 1 to 4 of the procedure in this section with “SYNC REC” is set to “Off”. Afterwards, set “SYNC REC” setting to “On”, and start recording (Ⓜ page 51).

Menu for playback

Menu for playback can be set with the remote only.

Items	Options	
SpeedCtrl	+100% - -50%,	Changes the playback speed. The normal playback speed can be varied in 15 steps.

To return to normal speed

Set the playback speed to 0 %.



When you set a playback speed other than 0 %, “SC” appears to the left of the time display in the display window of the remote.

Notes

- When using Speed Control, you may hear noise or an echo in the playback.
- The Virtual Surround, 6-Band Equalizer and Dynamic Normalizer functions are disabled while Speed Control is being used.

Menus for editing

Editing-related menus can be used on either the recorder or the remote.

Before editing

Make sure not to move or jog the recorder or disconnect the power source while editing or “SystemFILE WRITING” is displayed. If you do, the data edited up to that point may not be recorded to the disc, or data on the disc may be damaged.

Menus on the recorder

Select “Edit” in the menu.

Items	Options	
Move	Track Move	Changes the track order on the disc (Ⓞ page 56).
	Group Move	Changes the group order on the disc (Ⓞ page 56).
Erase	Track Erase	Erases a track. Can be used when the track you want to erase is played.
	Group Erase	Erases a group and all tracks in a group. Can be used when a track in the group you want to erase is played.
	All Tr Erase	Erases the entire disc. Can be used while the recorder is stopped.
Format*	Formats a disc to restore it to the condition it was in at the time of purchase.	

* Appears only for discs used in Hi-MD mode.

Menus on the remote

Items	Options	
Title (Ⓞ page 57)	Track	Adds a track name.
	Group	Adds a group name.
	Artist*	Adds an artist name to a track.
	Album*	Adds an album name to a track.
	Disc	Adds a disc name.

* Appears only for discs used in Hi-MD mode

The Erase function (“Erase”)

When erasing a track or a group

Note that once a recorded item has been erased, it cannot be recovered. Make sure to confirm the contents of the selected item before erasing it.

When erasing tracks that have been transferred from the computer

When you try to erase tracks that have been transferred from the computer, “TRACK FROM PC” and “ERASE OK?” appear in the display. If you erased tracks that have been transferred from the computer, the transfer authorization of the tracks will be as follows.

- If the tracks were transferred in Hi-MD mode, the transfer authorization of the tracks are restored automatically when you insert the disc into the recorder and then connect the recorder to the computer.
- If the tracks were transferred in MD mode, the transfer authorization of the tracks is lost. If you do not want to lose the transfer authorization, restore the authorization by transferring the tracks to the computer again before erasing them.

To erase a part of a track

Add track marks at the beginning and the end of the part you want to erase, then erase the part (Ⓞ page 47).

Notes

- You cannot use the “Erase” function to delete non-audio data (for example, text data or image data) on a disc used in Hi-MD mode.
- When all tracks in a group are deleted using the “Track Erase” function, that group is automatically deleted from the disc.

The Format function (“Format”)

When formatting a disc

When a disc is formatted, the number of transfer authorizations for the transferred tracks is affected as follows.

- For 1GB Hi-MD discs, the number of transfer authorizations for the transferred tracks is restored when the disc is inserted and the recorder is connected to the computer.
- For 60/74/80-minute standard discs, the number of transfer authorizations for transferred tracks decreases by one. To prevent the reduction, restore the transfer authorization by transferring the tracks to the computer again before formatting the disc.

Note

By formatting a disc, all data (including non-audio data) will be erased. If you think a disc contains such data, insert the disc into the recorder and connect the recorder to the computer to check the contents of the disc.

Moving a track on a disc

You can move a track from one group to another or from inside a group to outside the group. When you move tracks, track numbers are automatically renumbered. This function can be set on the recorder only.

- 1 While the recorder is stopped or playing the track you want to move, enter the menu (Ⓞ page 49) and select “Edit” – “Move” – “Track Move”.**

If the selected track is in the group, the group number to which the currently selected track belongs appears in the display.

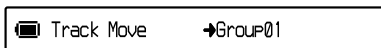

If the selected track is not in the group, the currently selected track number appears in the display.

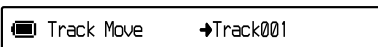

- 2 • If you are moving a track from inside a group to outside the group, or if there is no group on a disc**

Skip this step.

- If you are moving a track within the same group**
Press the jog lever while the group number to which the currently selected track belongs is displayed.
- If you are moving a track to a different group**
Move the jog lever toward FF/FR to select the destination group number, and then press the jog lever.

Select the destination group number.



- 3 Move the jog lever toward FF/FR to select the destination track number, and then press the jog lever to enter the selection.**

Select the destination track number.
(Example: when moving the selected track to the track number 10 in the group 02)



Note

If all tracks are moved out of the group, the group automatically disappears from the disc.

Changing the order of a group on a disc

This function can be set on the recorder only.

- 1 While the recorder is stopped or playing a track within a group whose order you want to change, enter the menu (Ⓞ page 49) and select “Edit” – “Move” – “Group Move”.**

The group number to which the currently selected track belongs appears in the display.

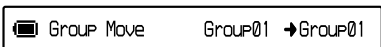

- 2 Move the jog lever toward FF/FR to select the destination group number, and then press the jog lever to enter the selection.**

Select the destination group number.
(Example: when moving “Group01” to the second group (Group 02))

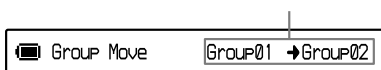

Adding titles (Title Input)

You can add titles while the recorder is playing or stopped.

- When adding a track name, artist name, or album name to a track:

Add the title while playing the track to be labeled or while the recorder is stopped.

- When adding a group name:

Add the title while playing a track in the group to be labeled or while the recorder is stopped.

This function can be set on the remote only.

Available characters

Capital and small letters of the alphabet for English and European languages*

Numbers 0 to 9

Symbols**

* European alphabets appear only for discs used in Hi-MD mode.

** The available symbols will differ for Hi-MD mode and MD mode.

Maximum number of characters per name

Track names, group names, artist names, album names and disc name: Approx. 200 each (containing a mixture of all available characters)

Maximum number of characters that can be input per disc*

In Hi-MD mode:

A maximum of about 55,000 characters

In MD mode:

A maximum of about 1,700 characters

* The number of titles that can be stored on a disc depends on the number of characters that are input for track names, group names, artist names, album names and disc name.

Note

If you enter the symbol “//” between the characters in disc names such as “abc//def”, you may be unable to use the group function (in MD mode only).

- 1 Enter the menu (☰ page 49) and select “Title”, and then select one of the following.

Title	Display
Track name	Track
Group name	Group
Artist name (to a track)*	Artist
Album name (to a track)*	Album
Disc name	Disc

* Appears only for discs used in Hi-MD mode.

2 Turn the VOL +/- control to select a letter and press the jog lever to enter.

The selected letter appears and the cursor moves to the next input position.

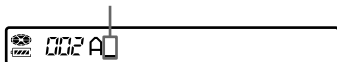

The buttons and control used for character input and their functions are listed below.

Functions	Operation
To move the cursor to the left or right.	Move the jog lever toward ◀◀/▶▶.
To enter a letter.	Press the jog lever (▶▶/ENT).
To switch between capital letters, small letters, and numbers/marks (A→a→0).	Press P MODE/↵.
To switch capital letters and small letters. (A→a)	Press SOUND.
To insert a blank space.	Press ☐+.
To delete a letter.	Press ☐-.

3 Repeat step 2 and enter all characters of the label name.

4 Press the jog lever for 2 seconds or more to enter the title.





Notes

- The recorder is able to display, but cannot label using Japanese “Katakana” characters.
- The recorder cannot rewrite a track name, a group name, an artist name, an album name, or a disc name of more than 200 letters that was created by another device (in MD mode only).

Option menus

Select “Option” in the menu. Option menus can be used on both the recorder and the remote.

Items	Options (item displayed on the remote is in parentheses) (●: Default settings)
AVLS ¹⁾	Off (AVLS Off) ● The volume changes without limiting the volume level.
	On (AVLS On) The volume is limited to minimize sound leakage or sound pressure on the ears. If the volume is turned up too high, “AVLS NO VOL OPERATION” appears and the volume is kept at a moderate level.
Beep	Off (Beep Off) The beep is turned off.
	On (Beep On) ● The beep sounds when you operate the recorder.

Items	Options (item displayed on the remote is in parentheses) (●: Default settings)	
EL Light ²⁾	Auto Off	When no operation has occurred for 10 seconds, the display window darkens. If no operation occurs for 5 more seconds, the display window automatically turns off to conserve battery power (only the battery level indication remains lit).
	On ●	The display window remains lit while the recorder is operating.
Backlight ³⁾	Auto ●	The backlight on the remote turns on when an operation occurs on the recorder or remote. If no operation has occurred for a few seconds, it automatically turns off again.
	On	The backlight stays on while the recorder is operating.
	Off	The backlight stays off.
Quick Mode	Off (Quick Off)	If you do not operate the recorder for a while, the recorder turns off automatically to prevent wearing down the battery.
	On (Quick On) ●	The recorder does not turn off automatically. Playback starts quickly after the playback button is pressed.
Disc Mode	Hi-MD ●	When you insert a 60/74/80-minute standard disc that contains no audio data or no data such as images, the disc mode is set to the Hi-MD mode.
	MD	When you insert a 60/74/80-minute standard disc that contains no audio data or no data such as images, the disc mode is set to the MD mode. If you want to use the disc recorded on this recorder on another component that does not support Hi-MD, record the disc with "Disc Mode" set to "MD."
Audio Out ²⁾	Headphone ●	Select when connecting the supplied remote to the  /LINE OUT jack on the recorder or when connecting headphones or earphones directly to the  /LINE OUT jack.
	Line Out	Select when using an optional audio connecting cord to connect the  /LINE OUT jack on the recorder to an external component for sound output.
Clock Set ²⁾	Sets the date and time ( page 61).	
FW Version ²⁾	Displays the version of the firmware in the recorder.	

¹⁾ AVLS stands for "Automatic Volume Limiter System".

²⁾ You can set with the recorder only.

³⁾ You can set with the remote only.

Setting for recorder display (“EL Light”)

Notes

- Even when “EL Light” is set to “Auto Off”, the display window will not turn off while:
 - the recorder is being used with the AC power adaptor.
 - charging the rechargeable battery.
 - the recorder is connected to a computer.
 - a menu item is being selected.
 - the recorder is fast forwarding, fast rewinding, or using AMS.
 - the Divide Rehearsal function is being performed.
 - messages are displayed.
- If the battery grows weak during recording (the level indication appears as ) , the display window darkens to conserve battery power regardless of the “EL Light” setting.
- The operation lamp does not turn off even when “EL Light” is set to “Auto Off”.

Setting for quick mode (“Quick Mode”)

Note

When “Quick Mode” is set to “On” (“Quick On” on the remote), power continues to flow in the recorder even when it is not being operated. The power is automatically cut off when the batteries become drained.

Setting for disc mode (“Disc Mode”)

Notes

- Even if you select “MD” as the “Disc Mode” setting, the operation mode can only be “Hi-MD” when using a 1GB Hi-MD disc.
- The operation mode set in the “Disc Mode” menu is applied to a blank 60/74/80-minute standard disc used on the recorder even if a different operation mode was selected in the SonicStage software or a different operation mode appeared on the display after the disc was formatted by the SonicStage software.

Setting for the /LINE OUT jack (“Audio Out”)

Notes

- If “Audio Out” is set to “Line Out”, Virtual Surround, 6-Band Equalizer, or Dynamic Normalizer will not function.
- “Audio Out” cannot be set to “Line Out” when the remote is connected.
- When you connect the headphones/earphones directly to the recorder, make sure to set “Audio Out” to “Headphone”.
- When “Audio Out” is set to “Line Out”, do not connect the headphones/earphones. The sound from the headphones/earphones will be very loud.
- If the recorder is connected to a component such as an active speaker and “Audio Out” is set to “Headphone”, make sure to set “Beep” to “Off” (“Beep Off” on the remote).

Setting the clock

Once the clock is set, the recorder automatically stamps the recording time and date for each track recorded. This function can be set on the recorder only.

1 When the recorder is stopped, enter the menu (Ⓢ page 49) and select “Option” – “Clock Set”.

2 Change the current year by pressing VOL +/-, and then press the jog lever.

The digit of the month flashes.

3 Repeat step 2 to enter the current month, date, hour, and minute.

When you press the jog lever to enter the minute, the clock starts operating.

To display the current time

While the recorder is stopped or recording, press DISPLAY/MENU (DISPLAY on the remote) repeatedly.

To select the 24-hour or 12-hour clock

While setting the clock, press DISPLAY/MENU.

To maintain the correct time

Once you set the clock, it will keep correct time as long as the recorder is connected to a power source, such as the charged rechargeable battery or house current. However, if no power source is connected or the rechargeable battery becomes depleted, the clock setting will change back to the factory setting after 3 minutes.



- While setting the clock, you can select the item to be set (year, month, date, etc.) by moving the jog lever toward FF/FR.
- If you connect the recorder to a computer and activate SonicStage, the clock on the recorder will be automatically set to match the computer's clock (only when the operation mode of the recorder is “Hi-MD mode”).

Notes

- Make sure the time is correctly set if you want the time stamp to be accurately recorded for an important recording.
- Under normal conditions, the clock may vary by about plus or minus 3 minutes per month.
- Transferred tracks will not include recorded date information even when the clock is set.
- When the computer changes to system suspend, sleep, or hibernation mode while the recorder is connected, power (bus power) supply to the recorder stops. Therefore, if the rechargeable battery is either depleted or it is not inserted in the recorder, the clock setting of the recorder will be lost.

Troubleshooting

If a problem occurs during recorder operation, follow the steps described below before consulting the nearest Sony dealer. If any messages appear, it is recommended to take notes.

- 1 Check to see if the problem is listed in “Troubleshooting.”
Check “Messages” (☞ page 71) for the problem as well.
- 2 If after step 1 you still cannot solve the problem, consult your nearest Sony dealer.

While charging

Symptom	Case and/or corrective action
The rechargeable battery does not start charging. The rechargeable battery cannot be fully charged.	<ul style="list-style-type: none"> → The rechargeable battery has been inserted incorrectly or the AC power adaptor, the AC power cord, or the USB cable has been connected incorrectly. Insert the rechargeable battery correctly or connect the AC power adaptor, the AC power cord, or the USB cable correctly. → No rechargeable battery is inserted. Insert the rechargeable battery (☞ page 14). → The rechargeable battery is depleted. Charge the rechargeable battery. It takes one minute after connecting the USB cable to the recorder for an indication to appear and charging to start. If charging does not start even after a minute, reconnect the USB cable to the recorder again. → The surrounding temperature is too high or too low (“CHARGE +5°C – +35°C/41F–95F” appears in the display). Charge the battery at a temperature of +5 °C (+41 °F) to +35 °C (+95 °F). → The battery will take longer to charge if you operate the recorder while charging the battery with the AC power adaptor, or do computer-related operations while charging with USB bus power. For faster charging, do not operate the recorder. → You pressed the jog lever or one of the buttons on the recorder at the time you connect the USB cable.
The rechargeable battery has become drained even when the recorder was not used for a while.	<ul style="list-style-type: none"> → “Quick Mode” was set to “On” (“Quick On” on the remote) (☞ page 59). If you set “Quick Mode” to “On” (“Quick On” on the remote), the power stays on inside the recorder even when there is no operation, causing the rechargeable battery life to shorten. If the rechargeable battery is not fully charged, the battery may become drained after a while. If this happens, charge the rechargeable battery again.
Even when fully charged, the life of the battery is only about half what it normally is. The remaining charging time is about a half the usual time.	<ul style="list-style-type: none"> → The capacity of the rechargeable battery has decreased because the battery is reaching the end of its service life. Replace the rechargeable battery with the new one (optional).
The recorder become hot during the charging procedure.	<ul style="list-style-type: none"> → This is normal and poses no danger.

While the recorder is connected to the computer

Symptom	Case and/or corrective action
The recorder is not recognized by the computer.	<ul style="list-style-type: none"> → The USB cable is not firmly connected. Connect the USB cable firmly to the recorder and the computer (☞ page 21). If the recorder is still not recognized, disconnect the USB cable, restart the computer, and then reconnect the USB cable. → A USB hub is used. Connect the USB cable directly to the USB port of the computer. → Network communication has failed. Disconnect the USB cable, wait at least 2 seconds, and then reconnect it. If the recorder is still not recognized, disconnect the USB cable, restart the computer, and then reconnect the USB cable. → In the case of Windows 2000 Professional, if you disconnect a USB cable after turning on or restarting the computer, the computer may not recognize the recorder when you reconnect the USB cable. In this case, disconnect the USB cable, restart the computer, and then reconnect the USB cable. Try updating your operating system also. → A disc is not inserted in the recorder. Check if a disc is inserted in the recorder. → The software installation failed. Disconnect the recorder and install the software again (☞ page 20).
The recorder is not recognized as an external device in Windows Explorer.	<ul style="list-style-type: none"> → The inserted disc is recorded in MD mode. Insert a disc recorded in Hi-MD mode. → A blank 60/74/80-minute standard disc has been inserted with "Disc Mode" in the menu set to "MD". Set "Disc Mode" to "Hi-MD" (☞ page 59).
Even though the USB cable is used to connect the recorder, the display on the recorder does not indicate it is connected.	<ul style="list-style-type: none"> → It takes time to recognize SonicStage. Please wait. → The other application software is running. Reconnect the USB cable after a while. If the computer still does not recognize the recorder, disconnect the USB cable, restart the computer, and reconnect the USB cable.
"RECONNECT USB" appears in the display.	<ul style="list-style-type: none"> → You operated the recorder or the computer before the recorder was recognized by the computer. Reconnect the USB cable (☞ page 21).
Charging by USB bus power cannot be done.	<ul style="list-style-type: none"> → The battery compartment lid is not firmly closed. Reinsert the rechargeable battery and close the battery compartment lid firmly. → The temperature of the battery-charging location is too low or too high. Charge the rechargeable battery within a temperature range of +5 °C (+41 °F) to +35 °C (+95 °F).

Continued ⇨

Symptom	Case and/or corrective action
The rechargeable battery cannot be charged sufficiently through USB bus power.	→ If you operate the recorder while it is connected to a computer, it takes time for the rechargeable battery to be sufficiently charged by USB bus power. For faster charging, do not operate the recorder.
The installation was not successful.	<ul style="list-style-type: none"> → You are using an OS that does not support this software (Ⓜ page 19). → All windows applications are not closed. If you start the installation while other programs are running, a malfunction may occur. This is especially true for programs that require large amounts of system resources, such as virus-check software. → There is not enough hard disk space on your hard disk. You need 200 MB or more free space on your hard disk.
The installation appears to have stopped before it has completed.	→ Check for the appearance of an error message beneath the installation window. Press the [Alt] key or [Tab] key to display any message that has appeared, and then follow the displayed instructions. If there is no message, the installation is still in progress. Wait a little while longer.
The progress bar on the display is not moving or the access lamp has not lit for a few minutes during the installation.	→ The installation is progressing normally. Please wait. The installation may take 30 minutes or more, depending on your CD drive or system environment.
You cannot record audio data when you press and slide the REC switch while using the MD Simple Burner software.	<ul style="list-style-type: none"> → The recorder is not correctly connected to the computer. Connect the recorder and your computer correctly using the USB cable. → Audio CD is not inserted in CD drive of the computer. Insert Audio CD. → The capacity of the disc is insufficient. Insert another disc.
Even though the recorder is recognized by the computer, it does not operate normally.	<ul style="list-style-type: none"> → A USB hub is used. Connect the USB cable directly to the USB port of the computer. → You are using the recorder at a place with vibration. Use the recorder at a place with no vibration.
The recorder cannot be used as a storage device.	→ The SonicStage or MD Simple Burner software is active. Close the SonicStage or MD Simple Burner software.
The playing time of a transferred track is different from the time that appears on your computer monitor.	→ This is due to a calculation discrepancy between the recorder and the computer.

Symptom	Case and/or corrective action
You cannot transfer audio data from your computer that will fill up the remaining recording time on the disc.	→ Due to the limitations of the system, the audio data is recorded in several-second steps. Therefore, when you record many short tracks, the total recording time increases but does not tally with the remaining recording time.
The disc size displayed on the computer is not the same as the disc size printed on the disc.	→ The difference is due to the use of the binary system to indicate the disc size on the computer and the decimal system to express the disc size on the disc (☞ page 30) and other recording media.
You cannot operate the recorder.	→ You cannot operate the recorder while the recorder is connected to the computer.
The lid does not open.	→ It happens if you disconnect the USB cable in the middle of a data transfer, recording, or editing operation on the computer, but while the rechargeable battery is missing from the recorder or is drained. Reconnect the USB cable or insert a fully charged rechargeable battery into the recorder, and then press ■ · CANCEL.

While recording

Symptom	Case and/or corrective action
The remaining recording time appears as "R 00:00" and recording cannot be done, even though 2.0 MB of free space is displayed.	→ This is a system limitation. 2.0 MB is the capacity of the reserve domain.
The recorder always creates a new group when recording.	→ The group recording ("Group REC") is set to "On". (You cannot overwrite tracks.) Set the group recording setting to "Off" (☞ page 51).
The first few seconds of a track cannot be recorded.	→ If you start recording before the operation mode appears and the operation lamp disappears in the display, data will not be recorded to the first few seconds of the first track. Wait until the operation mode appears and the operation lamp disappears before you start recording.
A new group cannot be created.	→ This occurs due to the MiniDisc system limitation (MD mode only). When the total number of characters used on a disc (for track names, artist names, album names, group names and disc name) is more than about 1,700, it becomes impossible to create a new group.

Symptom	Case and/or corrective action
Recording cannot be done correctly.	<ul style="list-style-type: none"> → Audio sources may not be securely connected. Disconnect the audio sources once and connect them again (☞ pages 31, 37). → There is no digital signal from the portable CD player. When recording digitally from a portable CD player, use the AC power adaptor and disable the anti-skip function (such as ESP) on the CD player. → The analog recording was made using a connecting cord with an attenuator. Use a connecting cord without an attenuator (☞ page 11). → Recording level is too small to record (when adjusting the recording level manually). Pause the recorder and adjust the recording level (☞ page 52). → The recorder is connected to the computer. Disconnect the recorder from the computer when recording. → The power sources was disconnected or a power outage occurred during recording. The recording result is not recorded on the disc. Make recording again. → Recording may not be done if the remaining recordable time on the disc is 48 seconds or less (“DISC FULL” appears). Replace the disc.
The lid does not open after recording.	<ul style="list-style-type: none"> → The lid does not open until “SystemFILE WRITING” disappears in the display.
“TRACK FULL” appears even before the disc has reached the maximum recording time and the recording cannot be done.	<ul style="list-style-type: none"> → This occurs due to the limitation of the system. When 2,047 tracks (on a disc used in Hi-MD mode) or 254 tracks (on a disc used in MD mode) have been recorded on the disc, “TRACK FULL” appears regardless of the total recorded time. More than 2,047 tracks or 254 tracks cannot be recorded on the disc. To continue recording, erase unnecessary tracks.
The remaining recording time does not increase even after erasing numerous short tracks.	<ul style="list-style-type: none"> → This occurs due to the MiniDisc system limitation (in MD mode only). Tracks of under 12 seconds (in SP mode), 24 seconds (in LP2 mode or monaural), or 48 seconds (in LP4 mode) in length are not counted and so erasing them may not lead to an increase in the recording time.

Symptom	Case and/or corrective action
The total recorded time and the remaining time on the disc may not total the maximum recording time (60, 74, or 80 minutes).	→ This occurs due to the MiniDisc system limitation (in MD mode only). Normally, recording is done in minimum units of approximately 2 seconds (in SP mode), 4 seconds (in LP2 mode or monaural), or 8 seconds (in LP4 mode). When recording is stopped, the last unit of recording always uses this unit of 2 seconds, 4 seconds, or 8 seconds even if the actual recording is shorter. Likewise, when recording is restarted after the stop, the recorder will automatically insert a blank space amounting to 2 seconds, 4 seconds, or 8 seconds before the next recording. (This is to prevent accidental erasing of a previous track whenever a new recording is started). Therefore, the actual recording time will decrease whenever a recording is stopped by a maximum of 6 seconds, 12 seconds, or 24 seconds.
"TRACK FULL" appears even before the disc has reached the maximum track number or recording time.	→ This occurs due to the MiniDisc system limitation. Repeated recording and erasing may cause fragmentation and scattering of data. Although those scattered data can be read, each fragment is counted as a track. In this case, the number of tracks may reach 2,047 (on a disc used in Hi-MD mode) or 254 (on a disc used in MD mode) and further recording is not possible. To continue recording, erase unnecessary tracks.
While playing	
Symptom	Case and/or corrective action
A disc is not played normally.	→ Repeat play is selected. Change back to normal play (⏮ page 44). → Playback mode is changed. Change back to "Normal" (⏮ page 43).
A disc is not played from the first track.	→ Disc playing stopped before it came to the last track. Press the jog lever (▶/ENT) (▶▶/ENT on the remote) for 2 seconds or more to start playing (⏮ page 40).
Playback sound skips.	→ The recorder is placed where it receives continuous vibration. Put the recorder on a stable place. → A very short track may cause sound to skip.
Momentary noise is heard.	→ Due to the special digital audio compression technology used in LP4 mode, momentary noise may occur on very rare occasions with certain sound sources.

Symptom	Case and/or corrective action
Sound has a lot of static.	→ Strong magnetism from a television or such device is interfering with operation. Move the recorder away from the source of strong magnetism.
The volume of the recorded track is low.	→ The track was recorded in analog mode or you used a connecting cord with an attenuator. Use a correct connecting cord without an attenuator. → The recording level was low. Adjust the recording level manually while recording (ⓘ page 52).
Volume cannot be turned up.	→ “AVLS” is set to “On” (“AVLS On” on the remote). Set to “Off” (“AVLS Off” on the remote) (ⓘ page 58).
No sound comes through the earphones.	→ The earphones plug is not firmly connected. Plug in the plug of the earphones firmly to the recorder. → The plug is dirty. Clean the plug.
The disc cannot be played on another component.	→ The component does not support Hi-MD. Discs used in Hi-MD mode can be played only on components that supports Hi-MD.
The edited tracks may exhibit sound dropout during search operations.	→ This occurs due to the MiniDisc system limitation. The fragmentation of data may cause sound dropout while searching because the tracks are played in higher speed than normal playback.
There is no R-channel sound output when playing a track recorded from a cassette deck or through an amplifier, or when listening to sound from a cassette deck or amplifier.	→ There is no R-channel output if the cassette deck or an amplifier is connected with a monaural cord. Make sure to use a stereo connecting cord.
You cannot play an MP3 audio track.	→ The type of MP3 supported by this recorder is MPEG-1 Audio Layer-3, transferred by the SonicStage software, with a sampling frequency of 32, 44.1 or 48 kHz.
Date and time of recording are not displayed.	→ Date and time of recording are displayed if they have been recorded. When an audio track is transferred from your computer, the recording date and time are not displayed.
The operation lamp flashes slowly during playback.	→ The operation lamp flashes slowly when the contents of an editing operation performed during playback or play-pause are ready to be written to the disc. When playback on the recorder is stopped, the edited contents are written to the disc and the operation lamp turns off.

While editing

Symptom	Case and/or corrective action
The lid does not open.	→ The recorder is saving the contents of an editing operation. The lid will not open until "SystemFILE WRITING" disappears from the display.
Editing cannot be done.	→ The power source has been disconnected or a power outage has occurred during editing. Do the editing operation again.
Non-audio data cannot be erased.	→ Non-audio data cannot be erased with the Erase function. Confirm the contents by connecting the recorder to your computer. If it is okay to delete the contents, disconnect the recorder from the computer, and then perform the Format function (🔧 page 54).
Tracks cannot be combined.	<p>→ This occurs due to the MiniDisc system limitations. When the tracks are scattered and the length of each track is short, you may not be able to combine the tracks.</p> <p>Combining tracks of the following lengths may not be possible.</p> <p>Hi-MD mode</p> <p>LinearPCM: 9 seconds or less</p> <p>Hi-SP: 8 seconds or less</p> <p>Hi-LP: 32 seconds or less</p> <p>MD mode</p> <p>SP: 12 seconds or less</p> <p>LP2/Monaural: 24 seconds or less</p> <p>LP4: 48 seconds or less</p> <p>→ You cannot combine tracks recorded in different recording modes, e.g., a track recorded in stereo and a track recorded in monaural; nor can you combine a track recorded with digital connection and a track recorded with analog connection.</p>
The disc cannot edit on other component.	→ The component does not support Hi-MD. Edit on other component that support Hi-MD.

Others

Symptom	Case and/or corrective action
The recorder does not work or works poorly.	<ul style="list-style-type: none">→ The rechargeable battery is not charged. Charge the rechargeable battery.→ The volume is low. Turn up the volume.→ No disc is inserted. Insert a recorded disc.→ The HOLD function is turned on. Disable HOLD by sliding the HOLD switch to the opposite direction of the arrow (Ⓢ page 15).→ The lid is not firmly closed. Close the lid until it clicks.→ Moisture has condensed inside the recorder if the recorder is brought directly from a cold to a warm location. Take the disc out and leave the recorder in a warm place for several hours until the moisture evaporates (Ⓢ page 78).→ The AC power adaptor, the AC power cord, or the USB cable is not firmly connected. Connect them firmly.→ The rechargeable battery is weak (“LOW BATTERY” flashes or nothing appears). Charge the rechargeable battery (Ⓢ page 14) or connect the recorder to a wall outlet.→ The disc is damaged or does not contain proper recording or editing data. Reinsert the disc. Rerecord the disc. If the error message still appears, replace it with another disc.→ There is a built-in malfunction in the system. While operating, the recorder received a mechanical shock, too much static, abnormal power voltage caused by lightning, etc. Disconnect all the power sources and the USB cable. Leave the recorder for about 30 seconds and connect the power source.
The display does not turn on.	<ul style="list-style-type: none">→ You tried to operate the recorder with the remote while “EL Light” is set to “Auto Off” (Ⓢ page 59). Use the buttons and controls on the recorder.
The operation mode of the blank 60/74/80-minute standard disc differs from the mode following formatting or the mode selected in the SonicStage software.	<ul style="list-style-type: none">→ When using a blank 60/74/80-minute standard disc in the recorder, the operation mode set in the “Disc Mode” menu is applied. Use the “Disc Mode” menu to change the operation mode as desired.

Messages

Message	Case and/or corrective action
ACCESS	→ The recorder is writing data to the disc or the computer is reading data on the disc while the recorder is connected to the computer. Wait until this process is completed.
ACCESS ERROR	→ The recorder failed to access the disc in the recorder while the recorder is connected to the computer. Reconnect the recorder to the computer or reinsert the disc.
AUDIO FILE ERROR	→ A disc which cannot be recorded or played back is inserted in the recorder. The audio data or disc management file has been damaged. Insert another disc.
AVLS NO VOL OPERATION	→ “AVLS” is set to “On” (“AVLS On” on the remote) and so the volume cannot rise higher. Set to “Off” (“AVLS Off” on the remote) (Ⓞ page 58).
BLANKDISC	→ A disc with no recording on it is inserted.
BUSY WAIT A MOMENT	→ The recorder is accessing disc information. You tried to operate the recorder while it was accessing the recorded data. Wait until the message goes out (in rare cases, it may take about a minute).
CANNOT EDIT	<ul style="list-style-type: none">→ You tried to combine tracks recorded in different recording modes.→ You tried to erase a track mark while selecting the first track in the disc.→ You tried to overwrite track marks.→ You tried to combine tracks whose combined length exceeds 999 minutes and 59 seconds.→ You selected “Edit” in the recorder menu or “Title” in the remote menu while recording.→ You selected “Format” in the menu while the recorder is not stopped.→ You tried to change a title that includes characters the recorder cannot edit.
CANNOT OPERATE	<ul style="list-style-type: none">→ You pressed II or T MARK on the recorder or P MODE/↵ on the remote during synchro-recording.→ You pressed SOUND on the remote while the Speed Control function is used.→ You pressed T MARK on the recorder for 2 seconds or more while editing a title (other than a disc name) on a disc used in MD mode, or while editing a title on a disc used in Hi-MD mode.
CANNOT PLAY	<ul style="list-style-type: none">→ You tried to play a track with playback restrictions.→ You tried to play an MP3 audio track that the recorder cannot play. The type of MP3 supported by this recorder is MPEG-1 Audio Layer-3, transferred by the SonicStage software, with a sampling frequency of 32, 44.1 or 48 kHz.

Message	Case and/or corrective action
CANNOT SET	<ul style="list-style-type: none"> → You selected “REC Mode” or “Group REC” in the recorder menu or “SpeedCtrl” in the remote menu while recording or in recording pause. → You selected “Time Mark” in the menu during digital recording or in recording-pasue. → You selected “REC Level” in the menu while the recorder is paused during synchro-recording. → You selected “REC Level” while the recorder is not stopped or in recording-pause. → You selected “MIC AGC” while “REC Level” in the menu has been set to “Manual”.
CHARGE +5°C–+35°C/41F–95F	→ You tried to charge the rechargeable battery at a place with a temperature outside the specified range for the recorder. Charge the battery at a temperature of +5° C (+41° F) to +35° C (+95° F).
DATA SAVE	→ The recorder is writing information to the system file, such as the recorded data or editing information. Wait until this process is completed. (Do not expose the recorder to physical shock, nor disrupt power supply.)
DC IN TOO HIGH	→ Voltage of the power supply is too high (The supplied AC power adaptor or the AC power cord is not used). Use the supplied AC power adaptor or the AC power cord.
DISC FULL	→ You tried to record on a disc that does not have enough space.
END	→ The recorder reached to the end of the last track in the selected play mode while playing or moving the jog lever toward FF (▶▶ on the remote). You pressed the jog lever (▶/ENT) (▶▶/ENT on the remote) at the end of the last track on the disc.
ERROR	→ There is a built-in malfunction in the system. While operating, the recorder received a mechanical shock, too much static, abnormal power voltage caused by lightning, etc. Disconnect all the power sources and the USB cable. Leave the recorder for about 30 seconds and connect the power source.
FORMAT ERROR DISC	<ul style="list-style-type: none"> → A disc with a format that the recorder does not support was inserted. Insert a standard MD or a disc used in Hi-MD mode. → A disc formatted on the computer without using the SonicStage software was inserted. When formatting a disc on the computer, make sure to use the SonicStage software.
HOLD	→ The recorder is locked. Slide HOLD against the arrow to unlock the recorder (Ⓞ page 15).
IN MENU	→ You operated the remote while selecting a menu on the recorder. Do the setting on the recorder. You operated the recorder while selecting a menu on the remote. Do the setting on the remote.

Message	Case and/or corrective action
LINE OUT NO VOL OPERATION	→ You tried to change the volume while “Audio Out” in the menu has been set to “Line Out”. Set “Audio Out” to “Headphone” (☞ page 59).
LOW BATTERY	→ The rechargeable battery is weak. Charge the rechargeable battery (☞ page 14).
MEMORY OVER	→ You tried to record with the recorder placed where it receives continuous vibration. Put the recorder on a stable place, and start recording again.
NO BookmarkedTRACK	→ You selected bookmark play without setting bookmarks. Set bookmarks (☞ page 43).
NO DIGITAL COPY	→ You tried to make a copy from a disc that is protected by the Serial Copy Management System. Make analog recording (☞ page 38).
NO DISC	→ You tried to play or record with no disc in the recorder. Insert a disc.
NO GROUP	→ You selected “Group Erase” or “Group Move” in the menu on the recorder, or “Title” – “Group” in the menu on the remote while using a disc with no groups.
NO INPUT SIGNAL	→ The recorder could not detect digital input signals. Make sure that the source is connected firmly (☞ page 37). If you are making an analog recording, ignore the message.
NON GROUPED TRACK	→ You selected “Group Erase” or “Group Move” in the menu on the recorder, or “Title” – “Group” in the menu on the remote while selecting a track that does not belong to a group.
NO TRACK	→ You tried to play a disc used in Hi-MD mode with no recorded tracks.
P/B ONLY DISC	→ You tried to record or edit on a premastered disc (P/B stands for “playback”). Insert a recordable disc.
PC--MD	→ You operated the recorder or the remote while the recorder is connected to the computer. Disconnect the recorder from the computer (☞ page 22).
PLAY MODE	→ You operated the recorder while selecting the playback mode on the remote.
PROTECTED DISC	→ You tried to record or edit on a disc with the tab in the record-protect position. Slide the tab back (☞ page 76).
PUSH STOP BUTTON	→ You tried to open the lid while the recorder was storing disc information with the recorder connected to a computer. Wait until “SystemFILE WRITING” has disappeared from the display after pressing ■ · CANCEL.
READ ERROR	→ The recorder cannot read the disc information correctly. Reinsert the disc.
REC ERROR	→ Recording was not correctly done. Place the recorder at a place with no vibrations and record again. → The disc is soiled with an oil film or finger prints, is scratched, or is not a standard disc. Try recording again with another disc.

Message	Case and/or corrective action
RECONNECT USB	→ You tried to operate the recorder or the computer before the recorder was recognized by the computer. Reconnect the USB cable.
REHEARSAL	→ You tried to operate on the remote while performing the Divide Rehearsal function (Ⓞ page 47). Do the setting on the recorder.
SORTING	→ The recorder is sorting information after you selected “Artist” or “Album” in the play mode.
SOUND	→ You operated the recorder while setting the Sound function (Ⓞ page 45) on the remote. Do the setting on the remote.
STANDBY	→ This message appears when the recorder, while connected to the computer, has written data to the disc once and is ready to write data again immediately. If you try to write data to the disc while “STANDBY” is not displayed, it may take a little time for writing to begin.
SystemFILE WRITING	→ The recorder is storing information (track start and end position) from the memory to the disc (Ⓞ page 80). Wait until this process is completed.
TEMP OVER REC STOP	→ Heat has built up in the recorder. Let the recorder cool down.
TitleFULL	→ You tried to enter characters that exceeds the maximum number (approximately 200 characters) for a title. → You tried to enter characters that exceeds the maximum number (approximately 55,000 characters in Hi-MD mode or 1,700 characters in MD mode) for a disc.
TOC DATA ERROR	→ The recorder cannot read the disc information correctly. Insert another disc.
TRACK FROM PC NO EDIT	→ You tried to combine or divide tracks that were transferred from the computer or recorded in Hi-MD mode using the MD Simple Burner software.
TRACK FROM PC NO REC	→ You tried to record in the middle of a protected track that has been transferred from the computer or you tried to record in the middle of a track that was recorded in Hi-MD mode with the MD Simple Burner software.
TRACK FULL	→ You tried to record more than 2,047 (on a disc used in Hi-MD mode) or 254 (on a disc used in MD mode) tracks. Erase unnecessary tracks (Ⓞ page 54).

Precautions

On safety

- Do not put any foreign objects in the USB cable connecting jack.
- Do not touch the optical pickup lens on the recorder and keep it clean. If you do so, the lens may be damaged and the recorder will not operate properly. To prevent dust from entering the recorder, make sure to keep the lid closed, except when inserting or taking out discs.

On power sources

- Use house current or rechargeable battery.
- Connect the AC power adaptor or the AC power cord to an easily accessible AC outlet. Should you notice an abnormality in the AC power adaptor or the AC power cord, disconnect it from the AC outlet immediately.
- The recorder is not disconnected from the AC power source (mains) as long as it is connected to the wall outlet, even if the recorder itself has been turned off.
- If you are not going to use this recorder for a long time, be sure to disconnect the power supply (AC power cord or rechargeable battery). To remove the AC power cord from the wall outlet, grasp the adaptor plug itself; never pull the cord.

On the recorder

- Do not shake or strike the recorder. In addition to malfunctions and inability, this may render the disc unusable or data breakdown, damage or loss may occur.
- Do not get the recorder wet. When you use the recorder in the rain or under similar conditions, be careful not to get the recorder wet.
- Your recorder is designed for use between the temperatures of 0 °C and 40 °C (32 °F and 104 °F). Shooting in extremely cold or hot places that exceed this range is not recommended.

- After using your recorder at the seashore or other dusty locations, clean your recorder carefully. Otherwise, the salty air may corrode the metal fittings or dust may enter the inside of your recorder, causing a malfunction.

On heat build-up

Heat may build up in the recorder if it is used for an extended period of time. This, however, is not a malfunction.

On mechanical noise

The recorder gives off mechanical noise while operating, which is caused by the power-saving system of the recorder and it is not a problem.

On installation

- If you use the recorder at a place subject to static or electrical noise, the recording may not be properly done or the recorded data may be lost.
- Never use the recorder where it will be subjected to extremes of light, temperature, moisture or vibration.
- Never wrap the recorder in anything when it is being used with the AC power adaptor. Heat build-up in the recorder may cause malfunction or damage.

On charging

- Do not use the supplied AC power adaptor, the AC power cord, or the USB cable to charge any other battery beside the supplied one or the one designated for it (LIP-4WM).
- Be sure to use the supplied AC power adaptor, the AC power cord, or the USB cable .
- Charge the rechargeable battery at a temperature of +5 °C (+41 °F) to +35 °C (+95 °F). The charging time will vary according to the surrounding temperature. (If the surrounding temperature is low, the required charging time will be longer. This is a characteristic of the lithium-ion battery.)
- If you do not use the recorder for a long time, disconnect the AC power cord from a wall outlet, remove the rechargeable battery from the recorder and keep it in the cool, dry place. To prevent degradation of the rechargeable battery, make sure not to store the rechargeable battery when it is either completely discharged or fully charged.
- The recorder may become hot during the charging procedure; this, however poses no danger.
- If the capacity of the rechargeable battery drops to half the normal amount, replace with the new one.
- If the recorder will be unused for a long time, remove the rechargeable battery, remove the USB cable from the recorder and remove the AC power cord from the wall outlet.

On the MiniDisc cartridge

- When carrying or storing the MiniDisc, keep it in its case.
- Do not break open the shutter.
- Do not place the cartridge where it will be subject to light, extreme temperatures, moisture or dust.
- Attach the supplied disc label only in the space designated for it on the disc. Do not stick it on any other disc surface.

To protect a recorded disc

To record-protect a disc, slide open the tab at the side of the disc. In this position, the disc cannot be recorded/edited. To record/edit again, slide the tab back so the tab is visible.

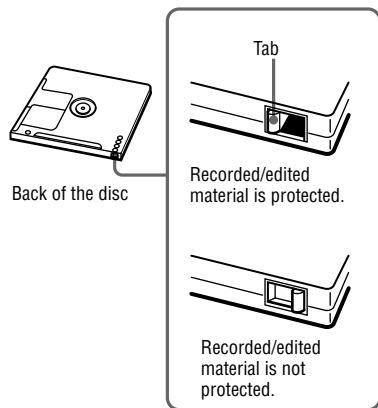

If you have any questions or problems concerning your recorder, please consult your nearest Sony dealer. (If a trouble occurred when the disc was in the recorder, we recommend that the disc be left in the recorder when you consult your Sony dealer so that the cause of trouble may be better understood.)

On the earphones

Road safety

Do not use earphones while driving, cycling, or operating any motorized vehicle. It may create a traffic hazard and is illegal in many areas. It can also be potentially dangerous to play your recorder at high volume while walking, especially at pedestrian crossings. You should exercise extreme caution or discontinue use in potentially hazardous situations.

Preventing hearing damage

Avoid using earphones at high volume. Hearing experts advise against continuous, loud and extended play. If you experience a ringing in your ears, reduce the volume or discontinue use.

Caring for others

Keep the volume at a moderate level. This will allow you to hear outside sounds and to be considerate of the people around you.

On the remote control

The supplied remote control is designed for use with this recorder only. The recorder cannot be operated with a remote control that was supplied with another device.

On cleaning

- Clean the recorder casing with a soft cloth slightly moistened with water or a mild detergent solution. Do not use any type of abrasive pad, scouring powder or solvent such as alcohol or benzene as it may mar the finish of the casing.
- Wipe the disc cartridge with a dry cloth to remove dirt.
- Dust on the lens may prevent the unit from operating properly. Be sure to close the disc compartment lid after inserting or ejecting a disc.
- To obtain the best sound quality, use a dry cloth to wipe the plugs of the headphones/earphones or the remote control. Dirty plugs may cause sound distortion or intermittent breaks in the sound.
- Clean the terminals on the rechargeable battery with a cotton swab or a soft cloth as illustrated.

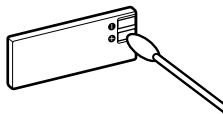

On the battery

Incorrect battery usage may lead to leakage of battery fluid or bursting battery. To prevent such accidents, observe the following precautions:

- Install the + and – poles of the battery correctly.
- When the recorder is not to be used for a long time, be sure to remove the battery.

On moisture condensation

If the recorder is brought directly from a cold to a warm location, or is placed in a very damp room, moisture may condense inside or outside the recorder. Should this occur, the recorder will not operate properly.

Moisture condensation occurs easily when:

- The recorder is brought from a cold location such as a ski slope into a warmly heated room.
- The recorder is taken from an air-conditioned room or car interior to the hot outdoors, etc.

How to prevent moisture condensation

When bringing the recorder from a cold place to a warm place, seal the recorder in a plastic bag and allow it to adapt to conditions at the new location over a period of time (about an hour).

If moisture condensation occurs

Turn off the recorder and wait about an hour for the moisture to evaporate. Make sure the moisture has evaporated before using the recorder.

Specification

Audio playing system

MiniDisc digital audio system

Systems

MiniDisc system, Hi-MD system

Laser diode properties

Emission duration: continuous

Laser output: less than 44.6 μ W

(This output is the value measured at a distance of 200 mm from the lens surface on the optical pick-up block with 7 mm aperture.)

Recording and playback time

See "List of the recording time for each disc"

( page 81)

Revolutions

Approx. 350 rpm to 3,600 rpm (CLV)

Error correction

Hi-MD:

LDC (Long Distance Code)/BIS (Burst Indicator Subcode)

MD:

ACIRC (Advanced Cross Interleave Reed Solomon Code)

Sampling frequency

44.1 kHz

Sampling rate converter

Optical (digital) input: 32 kHz/44.1 kHz/48 kHz

Audio formats supported by this recorder

Recording:

LinearPCM (44.1 kHz/16 bit)

ATRAC3plus (Hi-SP, Hi-LP)

ATRAC3 (LP2, LP4)

ATRAC (SP)

Playback:

LinearPCM

ATRAC3plus

ATRAC3

ATRAC

MP3 (for playback only) (MPEG-1 Audio Layer-3, sampling frequency 32/44.1/48 kHz, bit rate 32-320 kbps (fixed/variable bit rate))

ATRAC stands for **Adaptive TRansform Acoustic Coding**.

Modulation system

Hi-MD:

1-7RLL (Run Length Limited)/PRML (Partial Response Maximum Likelihood)

MD:

EFM (Eight to Fourteen Modulation)

Frequency response (During digital and analog input)

20 to 20,000 Hz \pm 3 dB

Input connectors*

MIC (PLUG IN POWER): stereo mini-jack

(minimum input level 0.13 mV)

LINE IN (OPT): stereo mini-jack for analog input

(minimum input level 49 mV)/optical (digital) mini-jack for optical (digital) input

Output connector

LINE OUT: stereo mini-jack (dedicated remote jack) / regulated output 194 mV (10 k Ω)

Maximum output (DC)

Headphones:

4.5 mW + 4.5 mW (16 Ω) (European model)

5 mW + 5 mW (16 Ω) (Other models)

Power requirements

Sony AC Power Adaptor DC 5 V AC 100 V - 240 V, 50/60 Hz

Lithium-ion rechargeable battery

LIP-4WM, 3.7 V, 370 mAh, Li-ion

Operating temperature

+5 °C (+41 °F) to +35 °C (+95 °F)

Battery operation time**

See "Battery life" (page 16)

Dimensions

Approx. 83.8 × 84.4 × 14.7 mm (w/h/d)

(3³/₈ × 3³/₈ × 1⁹/₃₂ in.) (excluding projecting parts and controls)

Mass

Approx. 96 g (3.4 oz.) (the recorder only)

Approx. 106 g (3.8 oz.) (including the rechargeable battery)

* The LINE IN (OPT) jack is used to connect either a digital (optical) cable or a line (analog) cable.

** Measured in accordance with JEITA.

US and foreign patents licensed from Dolby Laboratories.

Design and specifications are subject to change without notice.

Explanations

About Hi-MD

“Hi-MD” is a new MiniDisc format. Incorporating the new **ATRAC3plus** audio compression technology, Hi-MD is a new recording format that delivers longer recording times than standard MD discs. Hi-MD discs can also be used as a computer storage medium for non-audio data such as text and still images.

About ATRAC

ATRAC (Adaptive TTransform Acoustic Coding) is a generic term for an audio compression technology that realizes both high sound quality and high compression rates. Three versions are in use: **ATRAC** (SP mode (normal MD format)), **ATRAC3** (LP2 and LP4 modes) and **ATRAC3plus** (Hi-SP and Hi-LP modes). Compared with a CD, the compression rate for **ATRAC3** is about 10 times higher, and for **ATRAC3plus**, about 20 times higher.

“Hi-MD mode” and “MD mode”

This recorder has two operation modes, “Hi-MD mode” and “MD mode” that are automatically recognized whenever a disc is inserted.

Disc		Mode
1GB Hi-MD disc		Hi-MD
60/74/80-minute standard disc	Blank disc	The operation mode set in the “Disc Mode” (☞ page 59) menu is applied.
	Disc containing music in Hi-MD mode	Hi-MD
	Disc containing music in MD mode	MD

About LinearPCM

LinearPCM is a digital, non-compressed audio coding system. You can enjoy high-quality sound equal to that of CDs by recording in this mode.

The meaning of “no sound”

“No sound” describes a recorder condition in which the input level is about 4.8 mV during analog input or less than -89 dB during optical (digital) input (with 0 dB as full bit (the maximum recordable level for a MiniDisc)).

About System File

The system file is space on the disc that is used to store information other than audio files; for instance, track numbers.

If the MiniDisc were a book, the system file would correspond with the index or table of contents. The recorder rewrites the system file whenever an operation such as recording, adding or deleting track marks, or moving tracks has been done. (“SystemFILE WRITING” appears in the display when the recorder is rewriting the system file.) While the recorder is writing disc information, make sure not to move or jog the recorder or disconnect the power source as this may cause the information to be incorrectly recorded or the disc contents to be lost.

List of the recording time for each disc (Approx.)

The recording time is varied depending on disc type, disc mode, codec, and bit rate.

When using a disc in Hi-MD mode

When recording on the recorder			Recording time*		
Codec/ Bit rate	Recording mode on the recorder	1GB Hi-MD disc	80-minute standard disc	74-minute standard disc	60-minute standard disc
LinearPCM/ 1.4 Mbps	PCM	1 hour and 34 minutes	28 minutes	26 minutes	21 minutes
ATRAC					
ATRAC3plus/ 256 kbps	Hi-SP	7 hours and 55 minutes	2 hours and 20 minutes	2 hours and 10 minutes	1 hour and 40 minutes
ATRAC3plus/ 64 kbps	Hi-LP	34 hours	10 hours and 10 minutes	9 hours and 20 minutes	7 hours and 40 minutes
When transferring from the computer			Recording time*		
Codec/Bit rate		1GB Hi-MD disc	80-minute standard disc	74-minute standard disc	60-minute standard disc
LinearPCM/1.4 Mbps		1 hour and 34 minutes	28 minutes	26 minutes	21 minutes
ATRAC					
ATRAC3plus/352 kbps		5 hours and 30 minutes	1 hour and 35 minutes	1 hour and 30 minutes	1 hour and 10 minutes
ATRAC3plus/256 kbps		7 hours and 55 minutes	2 hours and 20 minutes	2 hours and 10 minutes	1 hour and 40 minutes
ATRAC3plus/192 kbps		11 hours	3 hours and 10 minutes	3 hours	2 hours and 20 minutes
ATRAC3plus/64 kbps		34 hours	10 hours and 10 minutes	9 hours and 20 minutes	7 hours and 40 minutes
ATRAC3plus/48 kbps		45 hours	13 hours and 30 minutes	12 hours and 30 minutes	10 hours
ATRAC3/132 kbps		16 hours and 30 minutes	4 hours and 50 minutes	4 hours and 30 minutes	3 hours and 40 minutes
ATRAC3/105 kbps		20 hours and 40 minutes	6 hours and 10 minutes	5 hours and 40 minutes	4 hours and 40 minutes
ATRAC3/66 kbps		32 hours and 40 minutes	9 hours and 50 minutes	9 hours	7 hours and 20 minutes
MP3**/128 kbps		17 hours	5 hours	4 hours and 30 minutes	3 hours and 30 minutes

* When transferring 4-minute tracks

**MP3 file formats are as follows: MPEG-1 Audio Layer-3/sampling frequency 44.1 kHz/fixed bit rate.

When using a disc in MD mode



When recording on the recorder			Recording time*	
Codec/Bit rate	Recording mode on the recorder	80-minute standard disc	74-minute standard disc	60-minute standard disc
ATRAC				
ATRAC/292 kbps	SP	1 hour and 20 minutes	1 hour and 14 minutes	1 hour
ATRAC3/132 kbps	LP2	2 hours and 40 minutes	2 hours and 28 minutes	2 hours
ATRAC3/66 kbps	LP4	5 hours and 20 minutes	4 hour and 56 minutes	4 hours
When transferring from the computer			Recording time*	
Codec/Bit rate		80-minute standard disc	74-minute standard disc	60-minute standard disc
ATRAC				
ATRAC (stereo)/292 kbps		1 hour and 20 minutes	1 hour and 14 minutes	1 hour
ATRAC3/132, 105 kbps		2 hours and 40 minutes	2 hours and 28 minutes	2 hours
ATRAC3/66 kbp		5 hours and 20 minutes	4 hour and 56 minutes	4 hours



* When transferring 4-minute tracks

About playing recorded discs on other MD components

The ability of an MD component to play back discs consisting of tracks recorded directly on the recorder or transferred from the computer depends on the disc type and audio format used for recording. Please refer to the following table for details.

Disc type	Format	Component used for playback		
		Component that supports Hi-MD*	Component that supports MDLP**	Component that does not support MDLP
1GB Hi-MD disc	Hi-MD	✓		
60/74/80-minute standard disc	Hi-MD	✓		
	MDLP	✓	✓	
	MD	✓	✓	✓

* Audio components marked with the  or  MD logo mark

**Audio components marked only with the  or  MDLP logo mark

Note on digital recording

This recorder uses the Serial Copy Management System, which allows only first-generation digital copies to be made from premastered software. You can only make copies from a home-recorded disc by using the analog (line out) connections.

Premastered software such as CDs or MDs

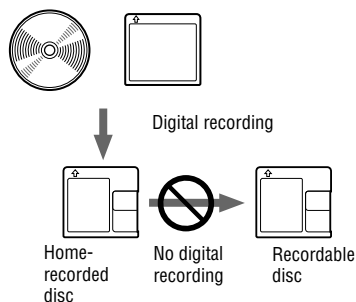

Microphone, record player, tuner, etc.
(with analog output jacks)

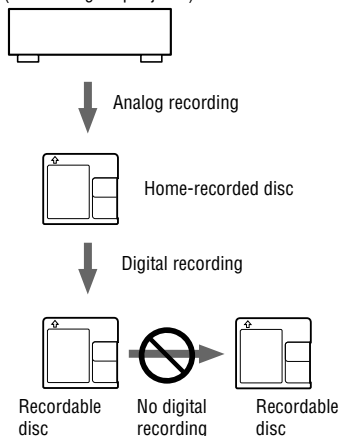

Restrictions on the editing of tracks transferred from your computer

This unit was designed so that editing functions (i.e., adding track marks and erasing track marks) do not function for tracks that have been transferred from your computer. This is to prevent the loss of transfer authorization by the transferred tracks. To edit these tracks, first transfer them into the computer, and then edit them on the computer.

About the DSP TYPE-S for ATRAC/ATRAC3

This recorder supports DSP TYPE-S, a specification for high-level Sony MiniDisc decks equipped with digital signal processors (DSP). This specification allows the recorder to produce high-quality sound from tracks recorded in MDLP mode. Since it retains DSP TYPE-R support, the recorder produces superior results during playback in SP (normal stereo) mode.

Suppressing the skips of the sound (G-PROTECTION)

The G-PROTECTION function was developed to provide a higher level of shock resistance than that of existing players.

Difference between digital (optical) and analog (line) inputs

The input jack of this recorder works as both digital and analog input jacks. Connect the recorder to a CD player or a cassette recorder using either digital (optical) input or analog (line) input. To record, see “Recording from externally connected component” (🔗 page 37) to record using digital (optical) input, and “When recording in analog” (🔗 page 38) to record using analog (line) input.

Difference	Digital (optical) input	Analog (line) input
Connectable source	Equipment with a digital (optical) output jack (CD player, DVD player, etc.)	Equipment with an analog (line) output jack (Cassette deck, radio, record player, etc.)
Usable cord	Optical cable (with an optical or an optical-mini plug) (🔗 page 37)	Line cable (with 2 phono plugs or a stereo-mini plug) (🔗 page 38)
Signal from the source	Digital	Analog Even when a digital source (such as a CD) is connected, the signal sent to the recorder is analog.
Track marks	Marked (copied) automatically <ul style="list-style-type: none">• at the same positions as the source (when the sound source is a CD or an MD).• after more than 2 seconds of no sound (🔗 page 80) or low-level segment (with a sound source other than a CD or an MD).• when the recorder is paused (3 seconds of no sound is encountered while synchro-recording).	Marked automatically <ul style="list-style-type: none">• after more than 2 seconds of no sound (🔗 page 80) or low-level segment.• when the recorder is paused while recording.
Recorded sound level	Same as the source. Can also be adjusted manually (Digital REC level control) (“Adjusting the recording level manually”, 🔗 page 52).	Adjusted automatically (depend on the recording level setting). Can also be adjusted manually (“Adjusting the recording level manually”, 🔗 page 52).

Note

Track marks may be copied incorrectly:

- when you record from some CD players or multi disc players using digital (optical) input.
- when the source is in shuffle or program play mode while recording using digital (optical) input. In this case, play the source in normal play mode.
- when programs with audio that is digitally broadcast (e.g., digital TV) are recorded through the digital (optical) input.

Index

Symbols

6-Band Equalizer 45

A

A-B Repeat 44
Analog recording 38
ATRAC 80
Audio format 79
AVLS 58

B

Backlight 59
Basic operations 33, 40
Battery life 16
Beep 58
Bookmark Play 43

C

Charging 14
Cleaning 77
Combine 48
Connecting 14, 21, 31

D

Data storage 30
Digital recording 37
Disc Mode 59
Disc type 17
Display window 35
Divide 47
Divide Rehearsal 47
DSP TYPE-S 83
Dynamic Normalizer 46

E

EL Light 59
Erase 54

F

Ferrite core 10
Firmware (FW Version) 59
Format 54

G

Group recording 51

H

Hi-MD 17, 80
HOLD 13, 15

I

Importing 23
Install 20

L

LinearPCM 80

M

MD Simple Burner 19, 27
Menu 49
Microphone recording 31
Microphone sensitivity 50
Moisture 78
Moving tracks/groups 56

O

Operation lamp 33
Operation modes 17, 32, 80
Optional accessories 11

P

Play mode 43

Q

Quick Mode 59

R

Recording level 32, 50, 52
Recording level for microphone (MIC AGC) 50
Recording mode 50
Recording time 81
Repeat Play 44

S

Setting the clock 61
Simple mode (MD Simple Burner) 27
SonicStage 19, 23
SonicStage Help 26
Speed control 53
Standard mode (MD Simple Burner) 28
Storage space 30
Supplied accessories 9
Synchro-recording 51
System File 80
System requirements 19

T

Title input 57
Track mark 33, 50
Transferring 24

U

USB bus power 15

V

Virtual-Surround 45

This warranty is valid only in Canada.

SONY[®]

Network Walkman ATRAC CD Player
Net MD Walkman ATRAC CD Walkman
Hi-MD Walkman IC Recorder
ATRAC HiFi Systems

LIMITED WARRANTY

Sony of Canada ("Sony") warrants this Product (including any accessories) against defects in material or workmanship as follows:

- 1. LABOUR:** For a period of 90 days from the date of purchase, if this Product is determined to be defective, Sony will repair or replace the Product, at its option, at no charge, or pay the labour charges to any Sony authorized service facility. After the Warranty Period, you must pay for all labour charges.
- 2. PARTS:** In addition, Sony will supply, at no charge, new or rebuilt replacements in exchange for defective parts for a period of one (1) year. After 90 days from the date of purchase, labour for removal and installation is available from Sony authorized service facilities or a Sony Service Centre at your expense.

You can extend the warranty period for an additional nine months by registering your product (www.sonymstyle.ca). Once you register your product, the limited warranty period is twelve months from the original date of purchase from Sony or a Sony authorized dealer. The ninety (90) day warranty period is extend-able only to the original purchaser, for an additional period of nine (9) months, for a total of twelve (12) months from the date of purchase when the Product is registered electronically. After the applicable period you must pay for all parts and labour charges.

To obtain warranty service, you must take the Product, or deliver the Product freight prepaid, in either its original packaging or packaging affording an equal degree of protection, to any authorized Sony service facility.

This warranty does not cover customer instruction, installation, set up adjustments or signal reception problems.

This warranty does not cover cosmetic damage or damage due to acts of God, accident, misuse, abuse, negligence, commercial use, or modification of, or to any part of the Product, including the antenna. This warranty does not cover damage due to improper operation or maintenance, connection to improper voltage supply, or attempted repair by anyone other than a facility authorized by Sony to service the Product. This warranty does not cover Products sold AS IS or WITH ALL FAULTS, or consumables (such as fuses or batteries). This warranty is valid only in Canada.

Proof of purchase in the form of a bill of sale or receipted invoice which is evidence that the unit is within the Warranty period must be presented to obtain warranty service.

This warranty is invalid if the factory-applied serial number has been altered or removed from the Product.

REPAIR OR REPLACEMENT AS PROVIDED UNDER THIS WARRANTY IS THE EXCLUSIVE REMEDY OF THE CONSUMER. SONY SHALL NOT BE LIABLE FOR ANY INCIDENTAL OR CONSEQUENTIAL DAMAGES FOR THE BREACH OF ANY EXPRESS OR IMPLIED WARRANTY ON THIS PRODUCT. EXCEPT TO THE EXTENT PROHIBITED BY APPLICABLE LAW, ANY IMPLIED WARRANTY OF MERCHANTABILITY OR FITNESS FOR A PARTICULAR PURPOSE ON THIS PRODUCT IS LIMITED IN DURATION TO THE DURATION OF THIS WARRANTY.

Some provinces do not allow the exclusion or limitation of incidental or consequential damages, or allow limitations on how long an implied warranty lasts, so the above limitations or exclusions may not apply to you. This warranty gives you specific legal rights, and you may have other rights which vary from province to province.

For your convenience, Sony of Canada Ltd. has established telephone numbers for frequently asked questions:

To locate the service or dealer nearest you, or for service assistance or resolution of a service problem, or for product information or operation, call:

Sony Customer Information Center

1-877-770-7669

or write to:

Sony of Canada Ltd.

115 Gordon Baker Road, Toronto, Ontario M2H 3R6 CANADA

or visit:

www.sonymstyle.ca/registration

This information is used to process your warranty registration and for after-sales support purposes. It may also be used by Sony of Canada Ltd. and affiliated Sony companies for customer relationship development and analysis, and to provide you with information and promotional offers on other products and services that may be of interest to you. For a copy of our Privacy Code, please visit our website at www.sonymstyle.ca/privacy or call 1-877-899-7669.

D 324511303

This warranty is valid only in the United States.

SONY

Portable Memory Stick Audio Player/Portable MiniDisc Recorder/
Portable CD Player/Portable IC Audio Player/Digital Music Player/
Portable Hard Disk Audio Player/Digital Media Player

Portable Audio

LIMITED WARRANTY (U.S. Only)

Sony Electronics Inc. ("Sony") warrants this product against defects in material or workmanship for the time periods and as set forth below. Pursuant to this Limited Warranty, Sony will, at its option, (i) repair the product using new or refurbished parts or (ii) replace the product with a new or refurbished product. For purposes of this Limited Warranty, "refurbished" means a product or part that has been returned to its original specifications. **In the event of a defect, these are your exclusive remedies.**

Labor: For a period of ninety (90) days from the original date of purchase of the product ("Labor Warranty"), Sony will, at its option, repair or replace with new or refurbished product, product determined to be defective. If Sony elects to replace the product after this Labor Warranty has expired but while the Parts Warranty below is still in effect, it will do so for the applicable labor charge.

Parts: For a period of one (1) year from the original date of purchase of product ("Parts Warranty"), Sony will supply new or refurbished replacement parts in exchange for parts determined to be defective.

This Limited Warranty covers only the hardware components packaged with the Product. It does not cover technical assistance for hardware or software usage and it does not cover any software products whether or not contained in the Product; any such software is provided "AS IS" unless expressly provided for in any enclosed software Limited Warranty. Please refer to the End User License Agreements included with the Product for your rights and obligations with respect to the software.

Instructions: To obtain warranty service, you must deliver the product, freight prepaid, in either its original packaging or packaging affording an equal degree of protection to the Sony authorized service facility specified. **It is your responsibility to backup any data, software or other materials you may have stored or preserved on your unit. It is likely that such data, software, or other materials will be lost or reformatted during service and Sony will not be responsible for any such damage or loss.** A dated purchase receipt is required. For specific instructions on how to obtain warranty service for your product,

Visit Sony's Web Site:

www.sony.com/walkmansupport

Or call the **Sony Network Portable Audio Support Line**
1-866-456-7669

For an accessory or part not available from your authorized dealer, call:

1-800-488-SONY (7669)

Repair / Replacement Warranty: This Limited Warranty shall apply to any repair, replacement part or replacement product for the remainder of the original Limited Warranty period or for ninety (90) days, whichever is longer. Any parts or product replaced under this Limited Warranty will become the property of Sony.

This Limited Warranty only covers product issues caused by defects in material or workmanship during ordinary consumer use; it does not cover product issues caused by any other reason, including but not limited to product issues due to commercial use, acts of God, misuse, limitations of technology, or modification of or to any part of the Sony product. This Limited Warranty does not cover Sony products sold AS IS or WITH ALL FAULTS or consumables (such as fuses or batteries). This Limited Warranty is invalid if the factory-applied serial number has been altered or removed from the product. This Limited Warranty is valid only in the United States.

LIMITATION ON DAMAGES: SONY SHALL NOT BE LIABLE FOR ANY INCIDENTAL OR CONSEQUENTIAL DAMAGES FOR BREACH OF ANY EXPRESS OR IMPLIED WARRANTY ON THIS PRODUCT.

DURATION OF IMPLIED WARRANTIES: EXCEPT TO THE EXTENT PROHIBITED BY APPLICABLE LAW, ANY IMPLIED WARRANTY OF MERCHANTABILITY OR FITNESS FOR A PARTICULAR PURPOSE ON THIS PRODUCT IS LIMITED IN DURATION TO THE DURATION OF THIS WARRANTY.

Some states do not allow the exclusion or limitation of incidental or consequential damages, or allow limitations on how long an implied warranty lasts, so the above limitations or exclusions may not apply to you. This Limited Warranty gives you specific legal rights and you may have other rights which vary from state to state.

D324343305



Printed on 100% recycled paper.



* 2 6 6 9 0 8 4 1 3 * (1)

<http://www.sony.net/> Printed in Malaysia