

# Portable MiniDisc Recorder

---

## Operating Instructions

Recorder Operation \_\_\_\_\_ **page 10**

Software Operation \_\_\_\_\_ **page 84**



Hi-MD  
AUDIO



"WALKMAN" is a registered trademark of Sony Corporation to represent Headphone Stereo products.  is a trademark of Sony Corporation.

## MZ-NH600

## WARNING

**To prevent fire or shock hazard, do not expose the unit to rain or moisture.**

Do not install the appliance in a confined space, such as a bookcase or built-in cabinet.

To prevent fire, do not cover the ventilation of the apparatus with news papers, table cloths, curtains, etc. And don't place lighted candles on the apparatus.

To prevent fire or shock hazard, do not place objects filled with liquids, such as vases, on the apparatus.

Certain countries may regulate disposal of the battery used to power this product. Please consult with your local authority.

### Caution

The use of optical instruments with this product will increase eye hazard.

**CAUTION — INVISIBLE LASER RADIATION WHEN OPEN**

**AVOID EXPOSURE TO BEAM**

**CAUTION — CLASS 1M INVISIBLE LASER RADIATION WHEN OPEN**

**DO NOT VIEW DIRECTLY WITH OPTICAL INSTRUMENTS**

### Information

IN NO EVENT SHALL SELLER BE LIABLE FOR ANY DIRECT, INCIDENTAL OR CONSEQUENTIAL DAMAGES OF ANY NATURE, OR LOSSES OR EXPENSES RESULTING FROM ANY DEFECTIVE PRODUCT OR THE USE OF ANY PRODUCT.

The validity of the CE marking is restricted to only those countries where it is legally enforced, mainly in the countries EEA (European Economic Area).

---

## Notice for users

### On the supplied software

- Copyright laws prohibit reproducing the software or the manual accompanying it in whole or in part, or renting the software without the permission of the copyright holder.
- In no event will SONY be liable for any financial damage, or loss of profits, including claims made by third parties, arising out of the use of the software supplied with this recorder.
- In the event a problem occurs with this software as a result of defective manufacturing, SONY will replace it. However, SONY bears no other responsibility.
- The software provided with this recorder cannot be used with equipment other than that which is so designated.
- Please note that, due to continued efforts to improve quality, the software specifications may be changed without notice.
- Operation of this recorder with software other than that provided is not covered by the warranty.
- The ability to display the languages on the software will depend on the installed OS on your PC. For better results, please ensure that the installed OS is compatible with the desired language you want to display.
  - We do not guarantee all the languages will be able to be displayed properly on the software.
  - User-created characters and some special characters may not be displayed.
- Depending on the type of the text and characters, the text shown on the software may not be displayed properly on the device. This is due to:
  - The capability of the connected device.
  - The device is not functioning normally.
- SonicStage and SonicStage logo are trademarks or registered trademarks of Sony Corporation.
- MD Simple Burner, OpenMG, “Magic Gate”, “MagicGate Memory Stick”, “Memory Stick”, Hi-MD, Net MD, ATRAC, ATRAC3, ATRAC3plus and their logos are trademarks of Sony Corporation.
- Microsoft, Windows, Windows NT and Windows Media are trademarks or registered trademarks of Microsoft Corporation in the United States and /or other countries.
- IBM and PC/AT are registered trademarks of International Business Machines Corporation.
- Macintosh is a trademark of Apple Computer, Inc. in the United States and/or other countries.
- Pentium is a trademark or registered trademark of Intel Corporation.
- All other trademarks and registered trademarks are trademarks or registered trademarks of their respective holders.
- ™ and ® marks are omitted in this manual.
- CD and music-related data from Gracenote, Inc., copyright © 2000-2003 Gracenote. Gracenote CDDB® Client Software, copyright 2000-2003 Gracenote. This product and service may practice one or more of the following U.S. Patents: #5,987,525; #6,061,680; #6,154,773; #6,161,132; #6,230,192; #6,230,207; #6,240,459; #6,330,593 and other patents issued or pending. Gracenote and CDDB are registered trademarks of Gracenote. The Gracenote logo and logotype, the Gracenote CDDB logo, and the “Powered by Gracenote” logo are trademarks of Gracenote.

Program © 2001, 2002, 2003, 2004 Sony Corporation

Documentation © 2004 Sony Corporation

# Table of contents

---

About available functions and supplied manuals .....	8
--	---

## *Recorder Operation*

---

Looking at controls .....	11
---------------------------	----

---

Getting started .....	13
-----------------------	----

---

Recording a disc right away! .....	15
------------------------------------	----

---

Playing a disc right away! .....	19
----------------------------------	----

---

Using menus .....	21
-------------------	----

How to use the menu items .....	21
---------------------------------	----

List of menus .....	22
---------------------	----

---

Various ways of recording .....	24
---------------------------------	----

Before recording .....	24
------------------------	----

Viewing various information .....	25
-----------------------------------	----

Recording from a TV or radio (Analog Recording) .....	26
---	----

Selecting the recording mode .....	27
------------------------------------	----

Adjusting the recording level manually .....	28
--	----

Adding track marks while recording .....	29
--	----

Using the group function when recording .....	30
---	----

To start/stop recording in sync with the sound source (Synchro-recording) .....	31
--	----

---

Various ways of playback .....	33
--------------------------------	----

Viewing various information .....	33
-----------------------------------	----

Selecting the play mode .....	34
-------------------------------	----

Searching for a track (Search) .....	38
--------------------------------------	----

Selecting the sound quality (6-Band Equalizer) .....	38
--	----

---

Editing recorded tracks .....	40
Before editing .....	40
Adding titles (Title) .....	40
Assigning tracks or groups as a new group (Group Set) .....	43
Releasing a group setting (Group Release) .....	44
Moving recorded tracks or groups (Move) .....	45
Erasing tracks and the entire disc (Erase) .....	47
Dividing a track (Divide) .....	49
Combining tracks (Combine) .....	49
Formatting the disc (Format) .....	50

---

Other operations .....	52
Changing the displayed menu items (Menu Mode) .....	52
Protecting your hearing (AVLS) .....	52
Turning off the beep sound .....	53
Storing the settings for individual discs (Disc Memory) .....	53
Starting the playback quickly (Quick Mode) .....	54
Selecting the disc mode (Disc Mode) .....	55
Adjusting the contrast of the display window (Contrast Adjustment) .....	55
Changing the operational direction of the display .....	56

---

Using the recorder with a computer .....	57
What you can do through connection with a computer .....	57
Connecting the recorder to your computer .....	57
Storing non-audio data to a disc .....	59

---

Additional information .....	61
Precautions .....	61
Specifications .....	63

---

Troubleshooting and explanations .....	65
Troubleshooting .....	65
Messages .....	74
Explanations .....	78

## Software Operation

---

What you can do with MD Simple Burner/ SonicStage .....	84
--	----

---

Installing .....	86
Providing the required system environment .....	86
Installing the software onto your computer .....	87

---

Using MD Simple Burner .....	89
Before using MD Simple Burner .....	89
Recording using MD Walkman operations (Simple mode) .....	90
Recording by computer operations (Standard mode) .....	91

---

Using SonicStage .....	93
Importing audio data .....	93
Transferring audio data from your computer to the MD Walkman .....	95
Transferring back audio data from the MD Walkman to your computer .....	97
Using SonicStage Help .....	100
Referring to SonicStage Help .....	102

---

Other information .....	104
Uninstalling SonicStage/MD Simple Burner .....	104
On copyright protection .....	105
Troubleshooting .....	106

---

Index .....	109
-------------	-----



# About available functions and supplied manuals

This section explains the functions of this portable MiniDisc recorder and the manuals that have been supplied with it. Please refer to the manual that applies to each use of the recorder.

## Learning more about Hi-MD

“Hi-MD” is a new MiniDisc format with advanced capabilities over the standard MD format.



The “What you can do with the Hi-MD Walkman” flyer

This flyer explains the major features of Hi-MD Walkman and how it differs with standard MD Walkman.

## Using the recorder

You can enjoy recording from a CD player, then enjoy listening to the recordings that you made.

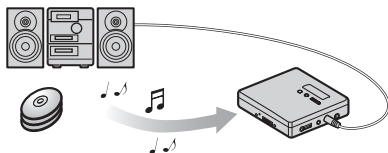

Recorder Operation (pages 10 to 82)

This section explains all of the recorder functions. It also gives details on the problems you may encounter while using the recorder and how to solve them, and about what to do when a message appears in the display.

➔ **When you encounter any problems or need more explanation**

Refer to “Troubleshooting and explanations” (page 65).



## Using the recorder while it is connected to a computer

The supplied SonicStage software allows you to transfer audio data between the recorder and the computer.

The supplied MD Simple Burner software allows you to record audio data to the recorder.

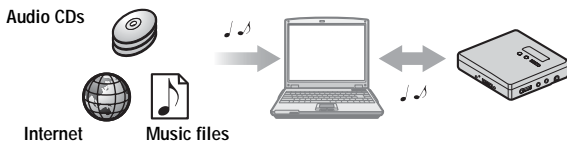

### Software Operation (pages 84 to 108)

This section explains the installation and basic operations of the supplied SonicStage/MD Simple Burner software.

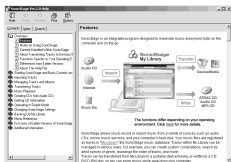

### SonicStage Help

This is an online help that you can view on your computer screen.

Online help explains the detailed operations and information about SonicStage software. You can also refer to online help if you encounter any problems while using the SonicStage.

### Notes on the “Software Operation” section

- In Software Operations section, “Net MD” refers to the recorder with a standard disc inserted and “Hi-MD” refers to the recorder with a Hi-MD disc or a standard disc in Hi-MD mode inserted.
- The displayed items in the illustrations that appear in this section may differ from the actual items displayed by the software.
- Explanations in this section assume familiarity with basic Windows operations. For details on the use of your computer and the operating system, please refer to the respective manuals.
- Explanations in this section cover general Hi-MD/Net MD products. For this reason, some explanations (and some illustrations) may not be applicable to your Hi-MD/Net MD. Please refer to the operating instructions of your Hi-MD/Net MD as well.

## Checking the supplied accessories

Headphones/earphones (1)

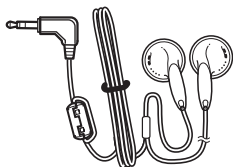

Dedicated USB cable (1)

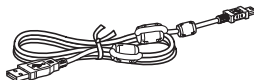

Small clamp filters for the AC power adaptor (2)

Attach the clamp filters when using the optional AC power adaptor (see page 64).

Large clamp filter for the optional line cable (1)

For details on the use of the clamp filter, refer to "How to use the supplied large clamp filter" supplied with this unit.

CD-ROM (SonicStage/MD Simple Burner) (1)\*

\*Do not play a CD-ROM on an audio CD player.

### Note

When using this unit, remember to follow the precautions below in order to avoid warping the cabinet or causing the unit to malfunction.

Make sure not to sit down with the unit in your back pocket.



# Looking at controls

## The recorder

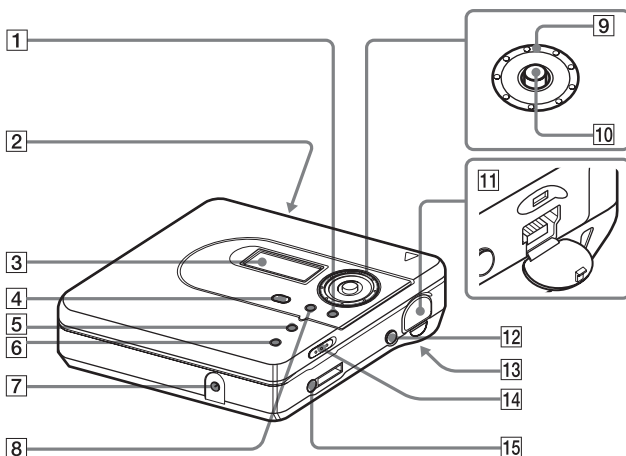

- 1** ■ (stop) • CANCEL button
- 2** OPEN switch
- 3** Display window
- 4** T MARK/REC (+▶) button
- 5** •NAVI/ ●MENU button  
Press lightly to go to the NAVI (navigation) setting mode (page 34).  
Press for 2 seconds or more to go to the MENU setting mode (page 21).
- 6** GROUP button
- 7** DC IN 3V jack  
When you use the optional AC power adaptor, connect it to this jack.
- 8** || (pause) button
- 9** Jog dial

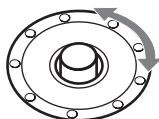

- 10** 5-way control key

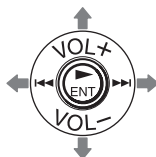

Operation	Function
Press ▶ENT <sup>1)</sup>	play, enter
Press towards ◀◀	find the beginning of the previous track, rewind
Press towards ▶▶	find the beginning of the next track, fast forward
Press towards VOL + <sup>1)</sup> or VOL -.	volume

<sup>1)</sup> There are tactile dots beside the ▶ENT and VOL + buttons.

- 11  USB cable connecting jack
- 12 LINE IN (OPT) jack
- 13 Battery compartment (at the bottom)

- 14 HOLD switch  
Slide the switch in the direction of the arrow to disable the buttons on the recorder. To prevent the buttons from being accidentally operated when you carry the recorder, use this function.

- 15  (headphones/earphones) jack

## The display window of the recorder

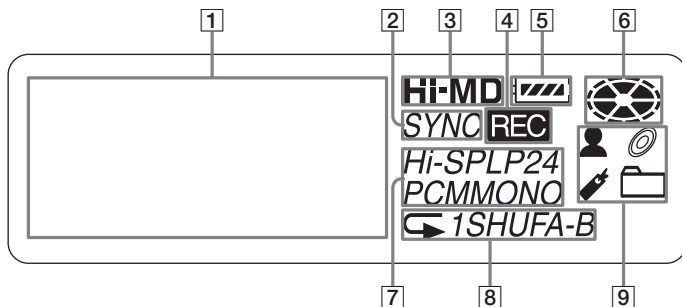

- 1 Character information display  
Displays the disc and track names, date, error messages, track numbers, etc.
- 2 SYNC (synchro-recording) indication
- 3 Hi-MD/MD indication  
“Hi-MD” lights up when the operation mode of the recorder is in Hi-MD mode and “MD” lights up when the operation mode is in MD mode.
- 4 REC indication  
Lights up during recording or file transfers from the computer. When flashing, the recorder is in record standby mode.
- 5 Battery indication  
Shows the approximate remaining battery power. If the battery is weak, the indication becomes empty and starts flashing.
- 6 Disc indication  
Shows that the disc is rotating for recording or playing.
- 7 Track mode (PCM, Hi-SP, Hi-LP, SP, LP2, LP4, MONO) indication
- 8 Sub play mode/Repeat play indications  
Shows the selected Sub play mode (single-track play, shuffle play, etc.) or Repeat play.
- 9 Main play mode indications  
Shows the selected main play mode (group play, bookmark play, etc.).

# Getting started

## 1 Insert an alkaline dry battery.

1 Slide OPEN to open the battery compartment lid.

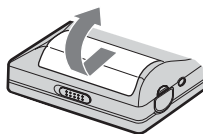

2 Insert a size-AA alkaline dry battery (minus terminal first).



3 Close the lid.

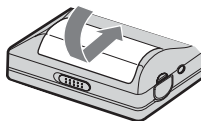

## 2 Make connections and unlock the controls.

1 Connect the headphones/earphones to .

2 Slide HOLD to the opposite direction of the arrow (→) on the recorder to unlock the controls.

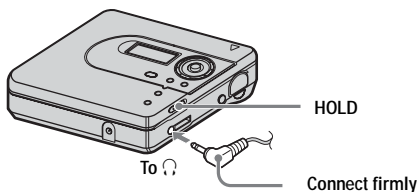

### When to replace the dry battery

You can check the battery condition on the display window of the recorder.



Battery power decreasing



Weak battery



The battery is drained.  
"LOW BATTERY" flashes in the display, and the power goes off.

The battery level indication is approximate. It may be more or less than the indication depending on the operating condition or the operating environment.

## Battery life<sup>1)</sup>

### Hi-MD mode (When using a 1GB Hi-MD disc)

(Unit: approx.hours)(JEITA<sup>2)</sup>)

When	Linear PCM	Hi-SP	Hi-LP
Recording continuously	2.5	3.5	4.5
Playing continuously	11.0	18.5	21.5

<sup>1)</sup> When using a new Sony LR6 (size AA) alkaline dry battery (produced in Japan)

<sup>2)</sup> Measured in accordance with the JEITA (Japan Electronics and Information Technology Industries Association) standard.

### Hi-MD mode (When using a 60/74/80-minute standard disc)

(Unit: approx.hours)(JEITA)

When	Linear PCM	Hi-SP	Hi-LP
Recording continuously	5.0	8.0	9.5
Playing continuously	9.5	17.0	20.0

### MD mode

(Unit: approx.hours)(JEITA)

When	SP Stereo	LP2 Stereo	LP4 Stereo
Recording continuously	7.5	9.5	11.0
Playing continuously	20.5	24.0	26.0

### Notes

- Stop the recorder before replacing the battery.
- It is preferable to use the recorder on house current (using the optional AC power adaptor) when recording or editing. When powering the recorder with a battery, make sure to use a new alkaline dry battery.
- When using a 1GB Hi-MD disc, the continuous recording time may be shortened if you repeatedly make short recordings.

# Recording a disc right away!

This section explains the basic procedure for making digital recordings using an optical cable connected to a CD player, Digital TV or other digital equipment. Make sure to use the optical cable.

- 1 Connect the optical cable to the recorder and an external component. (Insert the cables firmly and completely into the appropriate jacks.)

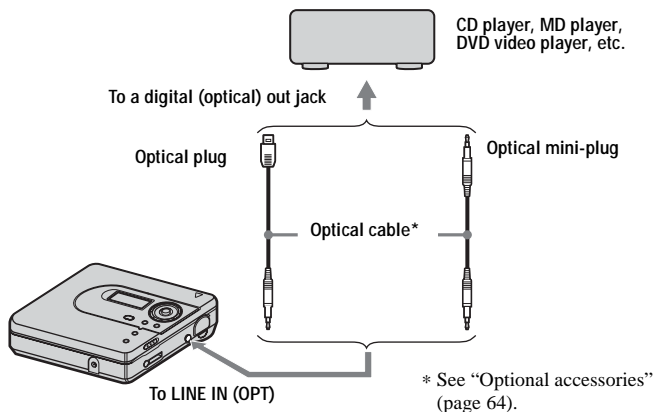

## Note

Make sure to disconnect the dedicated USB cable before recording.

## 2 Insert a recordable disc.

1 Slide OPEN to open the lid.

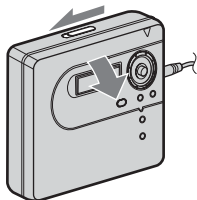

2 Insert a disc with the label side facing front, and press the lid down to close.

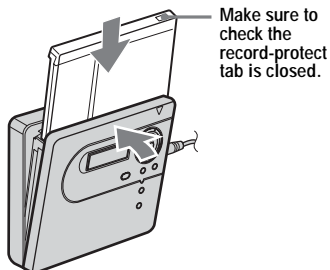

## 3 Confirm the operation mode.

This recorder has two operation modes, "Hi-MD mode" and "MD mode". The operation mode is automatically recognized whenever the disc is inserted. After you insert a disc, check the operation mode on the display window of the recorder.

"Hi-MD" lights up when the operation mode is Hi-MD and  
"MD" lights up when the operation mode is MD.

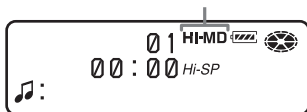

- When using a Hi-MD disc, the operation mode will only be Hi-MD.
- When using a standard disc (60/74/80 minutes), the operation mode can be set as follows.

Disc condition	Operation mode
Blank disc	The mode set for "Disc Mode" in the menu. <sup>1)</sup> The "Disc Mode" is factory set to "Hi-MD". If you want to use the disc on another component that does not support Hi-MD, set the "Disc Mode" to "MD" to use the disc in MD mode.
The disc contains material recorded in Hi-MD mode	Hi-MD
The disc contains material recorded in MD mode	MD

<sup>1)</sup> Refer to "Selecting the disc mode (Disc Mode)" (page 55) for the "Disc Mode" setting.



## 4 Record a disc.

- 1 Select and pause the sound source to be recorded.

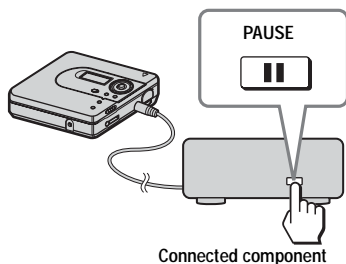

- 2 Make sure that disc indication has stopped rotating in the display window on the recorder.

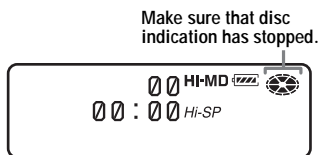

- 3 While the recorder is stopped, press and hold T MARK/REC and press ►ENT on the recorder.  
“REC” lights up and recording starts.

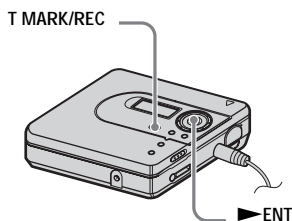

- 4 Play the source you want to record.

If you insert a previously recorded disc, the recording starts after the existing contents.

Track marks are automatically added at the same point as the sound source, and the contents are recorded together as a group.

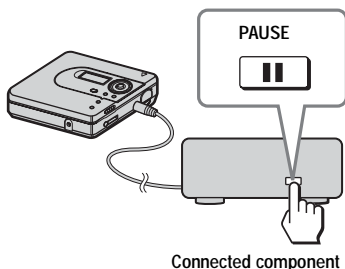

To	Press
Stop	Press ■.
Pause	Press ■ <sup>1)</sup> . Press ■ again to resume recording.
Remove the disc	Press ■ and open the lid. (The lid does not open while “SYSTEM FILE WRITING” flashing in the display.)

<sup>1)</sup> A track mark is added at the point where you press ■ again to resume recording while pausing; thus the remainder of the track will be counted as a new track.

## If the recording does not start



- Make sure the recorder is not locked (pages 12, 13).
- Make sure the disc is not record-protected (pages 16, 62).
- Premastered discs cannot be recorded over.

### Notes

- When you record on a 1GB Hi-MD disc, use a new alkaline dry battery (battery level indication shows ) , or connect the optional AC power adaptor to the recorder. When you attempt to start recording on a 1GB Hi-MD disc, “NotENOUGH POWER TO REC” may appear and recording cannot be done even if the battery level indication shows sufficient remaining power while the recorder is stopped or playing. This is because of a mechanism that disables recording when the remaining battery power is estimated by the recorder to be insufficient due to the high power consumption required for 1GB Hi-MD disc recording.
- Before making a recording while using the optional AC power adaptor, always insert a new alkaline dry battery into the recorder first to ensure that the recording operation completes successfully.
- Make sure to place the recorder at a stable, vibration-free place during recording.
- If you start recording when the disc indication is still rotating in the display, the first few seconds of the material may not be recorded. Make sure that the disc indication has stopped rotating before you start recording.
- Do not change the dry battery during operation even if the recorder is connected to AC power adaptor (not supplied). The operation may stop.
- Do not move or jog the recorder or disconnect the power source while recording, or while “DATA SAVE” or “SYSTEM FILE WRITING” is flashing in the display. If you do, the data recorded up to that point may not be recorded to the disc, or data on the disc may be damaged.
- Recording cannot be done when the disc does not have enough space for recording.

- If the power supply is disrupted (i.e. the battery is removed or becomes exhausted) during a recording or editing operation, or while “DATA SAVE” or “SYSTEM FILE WRITING” appears in the display, then it will not be possible to open the lid until power is restored.
- Note the following when recording from a portable CD player:
  - Some portable CD players may not be capable of digital out when the AC power adaptor is disconnected. If this is the case, connect the AC power adaptor to the portable CD player and use it on AC power as the power source.
  - On some portable CD players, optical output may not be possible when using an anti-skip function (e.g., ESP\* or G-PROTECTION). If this is the case, turn off the anti-skip function.
- \* Electronic Shock Protection



- The recorder is factory set to make a new group whenever recording is done. If you do not want to make a group, set “:REC” to “:REC Off” (page 30).
- To start recording from a specific point on the disc, pause the recorder at the desired point, and then start recording from that point.
- You can monitor the sound during recording. Connect the headphones/earphones to  and adjust the volume by pressing the 5-way control key towards VOL + or – on the recorder. This does not affect the recording level.

# Playing a disc right away!

## 1 Insert a recorded disc.

1 Slide OPEN to open the lid.



2 Insert a disc with the label side facing front, and press the lid down to close.

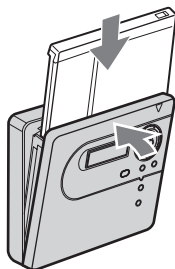

## 2 Play a disc.

1 Press the 5-way control key (▶ENT) on the recorder.

A short beep sounds in the headphones/earphones when you operate.

2 Press the 5-way control key towards VOL + or - to adjust the volume on the recorder.

The volume will be shown in the display.

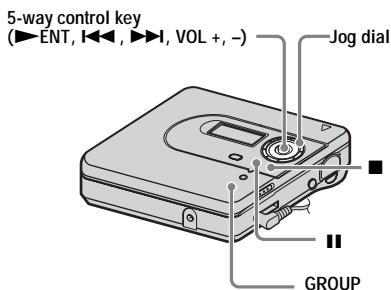

**To stop play, press ■.**

A long beep sounds in the headphones/earphones when you operate. Playback starts from the point you last stopped playing. After you stop the recorder, the recorder will automatically turn off in about 10 seconds (when using batteries) or about 3 minutes.

To	Operation on the recorder
Stop	Press ■.
Pause	Press ■■. Press ■■ again to resume play.
Select a track directly viewing track number or name	Turn the jog dial to select a track, and then press ►ENT to enter.
Find the beginning of the current track	Press the 5-way control key towards ◀◀◀. Press the 5-way control key towards ◀◀ repeatedly until you reach the beginning of the desired track.
Find the beginning of the next track	Press the 5-way control key towards ▶▶▶.
Go backwards or forward while playing	Press and hold the 5-way control key towards ◀◀ or ▶▶.
Search for a point in a track while viewing the elapsed time (Time search)	While pausing, press and hold the 5-way control key towards ◀◀ or ▶▶.
Search for a specific track while viewing track numbers (Index search)	While the recorder is stopped, press and hold the 5-way control key towards ◀◀ or ▶▶.
Cue to the next or previous group while playing a track in a group (Group skip). <sup>1)</sup>	Press GROUP, and then press the 5-way control key towards ◀◀ or ▶▶.
Start with the first track of the disc	While the recorder is stopped, press ►ENT for 2 seconds or more.
Remove the disc	Press ■ and open the lid. <sup>2)</sup>

<sup>1)</sup> Cues to the beginning of every 10th track during playback of the disc with no group settings.

<sup>2)</sup> Once you open the lid, the point to start play will change to the beginning of the first track.

## If the play does not start

Make sure the recorder is not locked (pages 12, 13).

### Note

The playback sound may skip if:

- the recorder receives stronger continuous shock.
- a dirty or scratched disc is played.

When using a disc in Hi-MD mode, the sound may drop out for a maximum of about 12 seconds.

## How to use the menu items

The recorder has many menus with useful functions for recording, playback, editing, etc. To set the menu items, do the following procedure.

If you are doing a menu operation for the first time after purchasing the recorder, "Menu Mode" flashes in the display. Before the menu operation, you can set "Menu Mode" to "Simple" (only basic menu items appear) or "Advanced" (all menu items appear). Refer to "Changing the displayed menu items (Menu Mode)" (page 52) for menu mode setting.

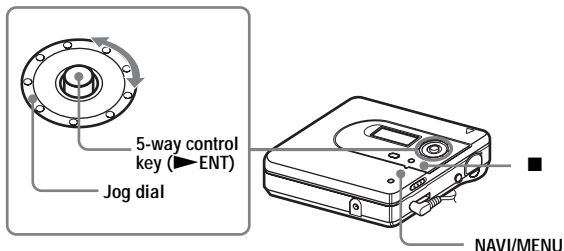

- 1 Press and hold NAVI/MENU for 2 seconds or more to enter the menu.

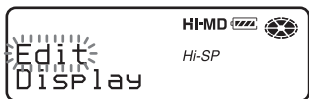

- 2 Turn the jog dial to select the item.
- 3 Press the 5-way control key (▶ENT) to enter the selection.
- 4 Repeat steps 2 and 3.

The setting will be entered when you press the 5-way control key (▶ENT) at the last.

To return the preceding setting

Press ■.

To cancel the operation while setting

Press ■ for 2 seconds or more.

## List of menus



The following table shows the menu items that you can select. Menu items can be set with the recorder only.

Items listed under “Menu 1” are the selectable items which appear when you enter the menu, and items listed under “Menu 2” are the selectable items which appear when you select an item in Menu 1.

It is possible to display all menu items only when “Menu Mode” is set to “Advanced”. Menu items with an asterisk (\*) are not displayed when “Menu Mode” is set to “Simple”. For details, see “Changing the displayed menu items (Menu Mode)” (page 52).

### Note

Different indication may be displayed depending on the operating conditions and disc settings.

Menu 1	Menu 2	Function	Site page
Edit	Title*	Adding a track name, artist name, album name, group name, or disc name.	page 40
	 : Set*	Assigns recorded tracks or groups to a new group.	page 43
	 : Release*	Releases group settings.	page 44
	Move*	Changes the order of tracks or groups.	page 45
	Erase	Erases tracks, groups, or the entire disc contents.	page 47
	Format*	Formats the disc and restores it to the condition it was in at the time of purchase (in Hi-MD mode only).	page 50
Display	Lap Time	Displays various information such as the recorder status, etc. in the display window.	page 25, page 33
	RecRemain (while recording and stopped)/ I Remain (while playing)		
	AllRemain		
	Title1/Title2		
	Sound*		
	Codec/ TrackMode*		
SubPMode	Normal	Selects the type of play, such as single-track play or shuffle play.	page 37
	I Track		
	Shuffle		
	A-BRepeat*		

<b>Menu 1</b>	<b>Menu 2</b>	<b>Function</b>	<b>Site page</b>
Sound	Normal	Customizes the equalizer mode settings.	page 38
	Sound EQ		
Useful*	Search*	Searches for tracks by track name, group name, artist name, or album name.	page 38
REC Set	REC Mode	Selects the recording mode (PCM, Hi-SP, or Hi-LP for Hi-MD mode/SP, LP2, LP4, or monaural for MD mode).	page 27
	RECVolume*	Manually adjusts the recording level.	page 28
	Time Mark*	Adds track marks automatically in a specific time interval.	page 29
	 :REC*	Sets the recorder to create a new group with each recording operation (Group Recording).	page 30
	SYNC REC*	Simplifies operations during digital recording (Synchro-Recording).	page 31
Option	Menu Mode	Changes the displayed menu items.	page 52
	AVLS*	Sets a limit on the maximum volume to protect your hearing.	page 52
	Beep*	Turns the beep sound on or off.	page 53
	Disc Mem*	Stores the recorder settings (Disc Memory).	page 53
	QuickMode*	Sets the recorder to start playback.	page 54
	Disc Mode	Selects from MD mode or Hi-MD mode when a blank disc is inserted.	page 55
	Contrast*	Adjusts the contrast of the display window on the recorder.	page 55
	Jog Dial*	Changes the operational direction on the display when turning the jog dial.	page 56

## Before recording

### Selecting the operation mode

This recorder has two operation modes, “Hi-MD mode” and “MD mode”. The operation mode is automatically recognized whenever the disc is inserted. After you insert a disc, check the operation mode on the display window of the recorder.

“Hi-MD” lights up when the operation mode is Hi-MD and “MD” lights up when the operation mode is MD.

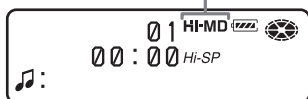

When you insert a standard disc (blank) into the recorder, you can use the Disc Mode function to specify use of the disc in Hi-MD mode or MD mode.

If you want to use the disc recorded on this unit on another component that does not support Hi-MD, record the disc with “Disc Mode” in the menu set to “MD”. Refer to “Selecting the disc mode (Disc Mode)” (page 55) for details.

### Selecting the Menu Mode

If the “Simple” menu mode is selected, some menu items will not be displayed. If you cannot find certain menu items while operating the recorder, make sure that the menu mode is set to “Advanced”.

For details on selecting the menu mode, see “Changing the displayed menu items (Menu Mode)” (page 52).

## Notes

- When you record on a 1GB Hi-MD disc, use a new alkaline dry battery (battery level indication shows ) , or connect the optional AC power adaptor to the recorder. When you attempt to start recording on a 1GB Hi-MD disc, “NotENOUGH POWER TO REC” may appear and recording cannot be done even if the battery level indication shows sufficient remaining power while the recorder is stopped or playing. This is because of a mechanism that disables recording when the remaining battery power is estimated by the recorder to be insufficient due to the high power consumption required for 1GB Hi-MD disc recording.
- Before making a recording while using the optional AC power adaptor, always insert a new alkaline dry battery into the recorder first to ensure that the recording operation completes successfully.
- Recording may not occur if the dedicated USB cable is connected to the recorder. Make sure to disconnect the dedicated USB cable before recording.
- If you start recording when the disc indication is still rotating in the display, the first few seconds of the material will not be recorded. Make sure that the disc indication has stopped rotating before you start recording.
- Do not move or jog the recorder or disconnect the power source while recording, or while “DATA SAVE” or “SYSTEM FILE WRITING” is flashing in the display. If you do, the data recorded up to that point may not be recorded to the disc, or data on the disc may be damaged.



## Viewing various information

You can check the remaining time, track number, etc. when recording or during stop.

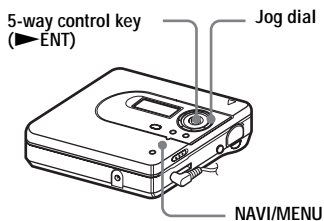

- 1 Enter the menu and select "Display".
- 2 Turn the jog dial until the information you want appears in the display, and then press ▶ENT to enter the selection.

Each turn changes the display as follows.

Lap Time → RecRemain →  
AllRemain → Title1/Title2 (Hi-MD)  
→ Sound

When you press ▶ENT, the selected information appears at **A**, **B** and **C**.

### Display window

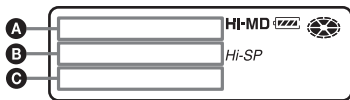

The indications have the following meanings:

- : Disc name
- : Track name
- : Group name
- : Artist name
- : Album name

### While the recorder is stopped **A/B/C**

<b>A</b>	<b>B</b>	<b>C</b>
Group number and track number	Elapsed time	<ul style="list-style-type: none"> <li>• Track name and artist name (Hi-MD)</li> <li>• Track name(MD)</li> </ul>
Group number and track number	<ul style="list-style-type: none"> <li>• Remaining time for recording / remaining free space (Hi-MD)</li> <li>• Remaining time for recording (MD)</li> </ul>	<ul style="list-style-type: none"> <li>• "RecRemain" and "FreeSpace" (Hi-MD)</li> <li>• "RecRemain" (MD)</li> </ul>
Numbers of tracks after the current track	Remaining time after the current location in the disc.	"AllRemain"
<ul style="list-style-type: none"> <li>• Disc name and artist name (Hi-MD)<sup>1)</sup></li> <li>• Disc name<sup>1)</sup></li> </ul>	<ul style="list-style-type: none"> <li>• Group name and album name (Hi-MD)<sup>3)</sup></li> <li>• Group name (MD)<sup>3)</sup></li> </ul>	Track name
Sound mode name <sup>2)</sup>	Indication of the selected sound mode <sup>2)</sup>	(none) <sup>2)</sup>

<sup>1)</sup> Track number appears if the currently selected track is not in a group.

<sup>2)</sup> This does not appear when "Menu Mode" is set to "Simple" (page 52).

<sup>3)</sup> The disc name appears when the currently selected track is not in a group.

## While recording **A/B/C**

<b>A</b>	<b>B</b>	<b>C</b>
Group number and track number	Elapsed time	Level meter
Group number and track number	Remaining time for recording.	"RecRemain"
<ul style="list-style-type: none"> <li>Disc name and artist name (Hi-MD)<sup>1)</sup></li> <li>Disc name (MD)<sup>1)</sup></li> </ul>	<ul style="list-style-type: none"> <li>Group name and album name (Hi-MD)<sup>2)</sup></li> <li>Group name (MD)<sup>2)</sup></li> </ul>	Track name

<sup>1)</sup> Track number appears if the currently selected track is not in a group.

<sup>2)</sup> The disc name appears when the currently selected track is not in a group.

### Notes

- When using the disc in Hi-MD mode, the free space will show as "2.0MB" when the remaining recording time becomes "-0:00:00". This is a system limitation, "2.0MB" being the capacity of the reserve domain.
- Depending on the group settings, the operating conditions, and the disc settings, you may not be able to select certain indications or the indications may appear differently.



If you want to check the playing position or track name while playing, see "Viewing various information" (page 33).

## Recording from a TV or radio (Analog Recording)

This section explains how to record from equipment with analog output, such as a cassette recorder, radio, or TV.

This operation can be done on the recorder only.

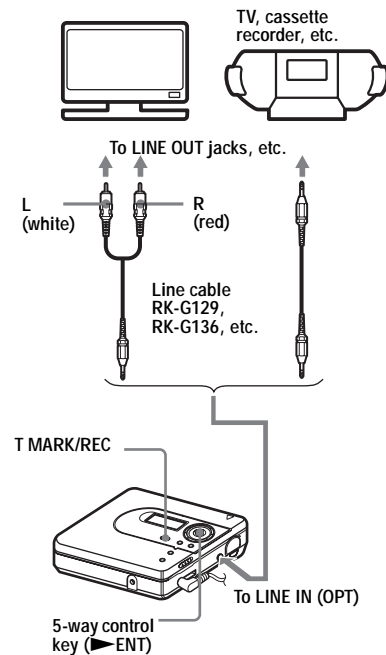

### 1 Make connections.

Use the appropriate connecting cord to suit the source equipment. For details, see "Optional accessories" (page 64).

### 2 Press ▶ENT while pressing T MARK/REC to start recording.

### 3 Play the source you want to record.

## Selecting the recording mode

Select each recording mode according to the recording time that you want.

**Discs recorded in Hi-MD or MD (MDLP) mode can be played back only on MD players or recorders with Hi-MD or MD (MDLP) playback mode.**

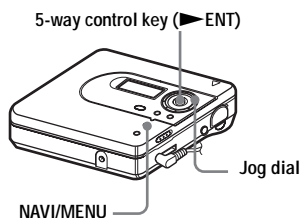

- 1 While the recorder is stopped, enter the menu and select “REC Set” - “REC Mode”.
- 2 Turn the jog dial to select the desired recording mode, and then press ▶ENT to enter the selection.

The recorder keeps the setting of the recording mode when you record the next time.

### When recording on a disc used in Hi-MD mode

Recording mode	Display	Recording time
Linear PCM stereo	PCM	<ul style="list-style-type: none"> <li>• Approx. 28 min. on an 80-minute standard disc</li> <li>• Approx. 94 min. on a 1GB Hi-MD disc</li> </ul>
Hi-SP stereo	Hi-SP	<ul style="list-style-type: none"> <li>• Approx. 140 min. on an 80-minute standard disc</li> <li>• Approx. 475 min. on a 1GB Hi-MD disc</li> </ul>

Recording mode	Display	Recording time
Hi-LP stereo	Hi-LP	<ul style="list-style-type: none"> <li>• Approx. 610 min. on an 80-minute standard disc</li> <li>• Approx. 2,040 min. on a 1GB Hi-MD disc</li> </ul>

### When recording a disc used in MD mode

Recording mode <sup>1)</sup>	Display	Recording time <sup>3)</sup>
SP stereo	SP	Approx. 80 min.
LP2 stereo	LP2	Approx. 160 min.
LP4 stereo	LP4	Approx. 320 min.
Monaural <sup>2)</sup>	MONO	Approx. 160 min.

<sup>1)</sup> For better sound quality, record in normal stereo (SP) or LP2 stereo mode.

<sup>2)</sup> If you record a stereo source in monaural, the sounds from left and right will be mixed.

<sup>3)</sup> When using an 80-minute recordable disc



Audio components that support the linear PCM stereo, Hi-SP stereo and Hi-LP stereo mode are indicated by the MD or MD logo mark. Audio components that support the LP2 stereo and LP4 stereo mode are indicated by the MDLP or MDLP logo mark.

### Notes

- It is recommended that you use the AC power adaptor (not supplied) for long recordings.
- When you record in LP4 mode, momentary noise may be produced on very rare occasions with certain sound sources. This is because of the special digital audio compression technology that enables the long time recording. If noise is produced, it is recommended that you record in normal stereo or LP2 mode to obtain better sound quality.
- It is recommended that you use the recorder to edit (dividing or combining) long tracks recorded in linear PCM stereo. Transferring such tracks and editing them on a computer may require an extremely long time.

## Adjusting the recording level manually

The recording level is adjusted automatically while recording. If necessary, you can set the recording level manually during both analog and digital recording.

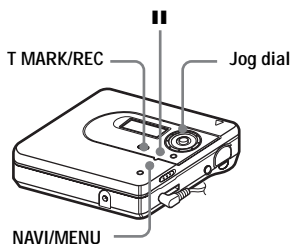

- 1 Press and hold T MARK/REC and press **II**.  
The recorder stands by for recording.
- 2 Enter the menu and select “REC Set” - “RECVolume” - “Manual”.
- 3 Play the source.
- 4 While observing the level meter in the display, adjust the recording level by turning the jog dial.

Set the level so that the meter segments light up around  $-12\text{dB}$  segment.

If a high sound level causes the level meter to reach the OVER segment, lower the recording level.

Each level meter shows the following.  
Upper — L channel input level  
Lower — R channel input level

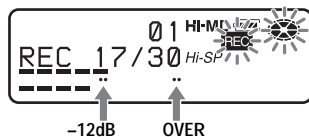

- 5 Press **II** again to start recording.  
If your source is an externally connected component, play the source to the beginning of the material to be recorded, and then start recording.

To switch back to automatic level control

Select “Auto (AGC)” in step 2.

### Notes

- You cannot adjust the left and right channel levels separately.
- Once you stop recording, the recorder will revert to automatic recording level adjustment mode the next time you start a recording operation.
- To adjust the recording level manually during synchro-recording, do steps 1 to 4 of the procedure in this section with “SYNC REC” is set to “SYNC Off”. Afterwards, set “SYNC REC” setting to “SYNC On”, and start recording (page 31).

## Adding track marks while recording

You can add track marks (track number) while recording to divide the material into separate parts, that allow you to go to specific track quickly and easily.

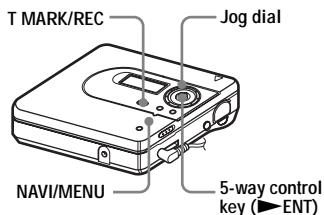

### Adding track marks manually

While the recorder is recording, press T MARK at the point you want to add a track mark.

### Adding track marks automatically (Auto Time Mark)

Use this feature to add track marks automatically at specified intervals when recording through the analog input connector. This function is convenient for recording long period of time, such as lectures, meetings, etc.

- 1 While the recorder is recording or in recording pause, enter the menu and select “REC Set” - “Time Mark” - “On”.
- 2 Turn the jog dial until the desired time interval appears in the display, and then press ▶ENT to enter the selection.

One rotation changes the time setting (Time:) by 1 minute, within the range of 1 to 60 minutes.

To cancel Time Mark

Select “Off” in step 1.

Using Time Mark to add track marks while recording

#### When the elapsed recording time exceeds the time interval for Time Mark:

The recorder adds track marks at the point you set the time interval and from that point the recorder adds a track mark whenever the time interval has elapsed.

**Example:** Eight minutes of recording has been completed when the Time Mark time interval is set to 5 minutes. A track mark will be added at the 8-minute point (after the start of recording) and after each 5-minute interval thereafter.

#### When the time interval set for Time Mark exceeds the elapsed recording time:

The recorder adds track marks when the set Time Mark time interval has elapsed.

**Example:** Three minutes of recording has been completed when the Time Mark time interval is set to 5 minutes. A track mark will be added at the 5-minute point (after the start of recording) and after each 5-minute interval thereafter.



“T” appears before the time display for track marks added by Time Mark.

#### Notes

- If you add a track mark by pressing T MARK or II, etc. while recording, Time Mark will begin automatically adding track mark each time the selected time interval as elapsed.
- The setting is canceled when you connect a digital optical cable to the recorder.

## Using the group function when recording

What is the group function?

The group function is provided to allow playback of discs with group settings. The group function is convenient for playback of discs on which several albums or CD singles have been recorded.

What is a disc with group settings?

The recorder can operate various functions in units of group; that is tracks that have been recorded on a disc as part of separate groups, as shown below.

Before group settings are made

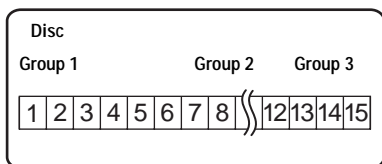

Track 1 to 5 are assigned to group 1.  
Track 8 to 12 are assigned to group 2.  
Track 13 to 15 are assigned to group 3.  
Track 6 to 7 are assigned to no group.

After group assignments have been made

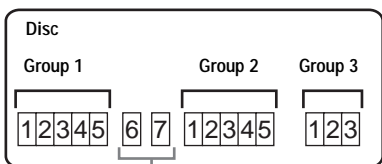

Tracks that were not assigned to a group are treated as being part of "Group -".

You can create a maximum of 255 groups on a Hi-MD disc or a standard disc in Hi-MD mode and 99 groups on a standard disc in MD mode.

### Note

It will not be possible to make a group setting if the tracks, groups and disc name on a disc exceed the maximum number that can be input (in MD mode only).

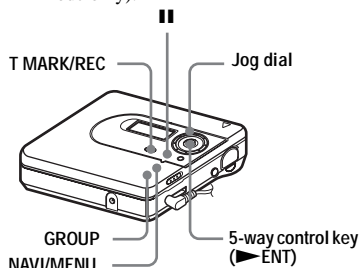

## To create a new group automatically when recording

The recorder is factory set to create a new group automatically when recording. This is convenient when recording several CDs in succession. You can check the group recording setting as follows.

While the recorder is stopped, enter the menu and select "REC Set" - "☐:REC" - "☐: REC On".

To record without creating a new group

Select "☐:REC Off" at the end of the procedure above.

## Recording tracks to an existing group

You can add a track to an existing group.

Adding a new track at the end of the selected group

- 1 While the recorder is stopped and the group to which you want to add a track is selected, press ►ENT while pressing T MARK/REC and GROUP.
- 2 Play the sound source.  
A new track will be added at the end of the current contents within the group.

Adding a track at a desired position within the selected group

- 1 While the recorder is play-paused at the point within the group where you want to add a new track, press ►ENT while pressing T MARK/REC and GROUP.
- 2 Press II to start recording and play the sound source.

## To start/stop recording in sync with the sound source (Synchro-recording)

During synchro-recording, the starting and stopping of recording occurs are synchronized with the sound source. This simplifies digital recordings (e.g., from a CD player) since the need to operate the recorder or the sound source is eliminated. Synchro-recording is only possible with the optical cable connected.

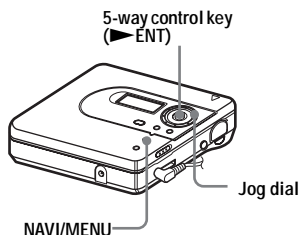

- 1 Make connections.  
Use the appropriate optical cable to suit the source equipment. For details, see “Optional accessories” (page 64).
- 2 While the recorder is stopped, enter the menu and select “REC Set” - “SYNC REC” - “SYNC On”.



When there is no sound from the player for about 3 seconds during synchro-recording, the recorder goes into the standby mode automatically. When the sound comes from the player again, the recorder resumes synchro-recording. If the recorder is kept in the standby mode for 5 minutes or longer, the recorder stops automatically.

## Notes

- The pause function cannot be turned on or off manually during synchro-recording.
- Do not switch the “SYNC REC” setting while recording. Recording may not be done properly.
- Even when there is no sound on the sound source, there may be cases when recording does not pause automatically during synchro-recording due to the noise level emitted from the sound source.
- If a silent portion is encountered for approximately 2 seconds during synchro-recording from a sound source other than a CD or an MD, a new track mark is automatically added at the point where the silent portion ends.



## Viewing various information

You can check the track name, disc name, etc. during playback.

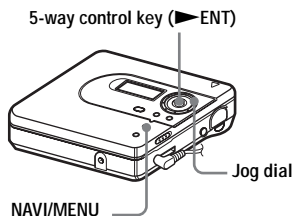

- 1 While playing, enter the menu and select "Display"
- 2 Turn the jog dial until the information you want appears in the display, and then press ▶ENT to enter the selection.

Each turn changes the display as follows.

Lap Time → 1 Remain →  
 AllRemain → Title1/Title2 (Hi-MD)  
 → Sound → Codec (Hi-MD)/  
 TrackMode (MD)

When you press ▶ENT, the selected information appears at **A**, **B** and **C**.

## Display window

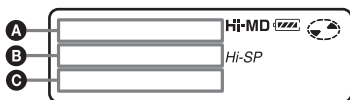

The indications have the following meanings:

- : Disc name
- : Track name
- : Group name
- : Artist name
- : Album name

## Display window **A/B/C**

<b>A</b>	<b>B</b>	<b>C</b>
Group number and track number	Elapsed time	<ul style="list-style-type: none"> <li>• Track name and artist name (Hi-MD)</li> <li>• Track name (MD)</li> </ul>
<ul style="list-style-type: none"> <li>• Track name and artist name (Hi-MD)</li> <li>• Track name (MD)</li> </ul>	Remaining time of the current track	"1 Remain"
Numbers of tracks after the current track	Remaining time after the current location in the disc.	"AllRemain"
<ul style="list-style-type: none"> <li>• Disc name and artist name (Hi-MD)<sup>1)</sup></li> <li>• Disc name (MD)<sup>1)</sup></li> </ul>	<ul style="list-style-type: none"> <li>• Group name and album name (Hi-MD)<sup>3)</sup></li> <li>• Group name (MD)<sup>3)</sup></li> </ul>	Track name
Sound mode name <sup>2)</sup>	Indication of the selected sound mode <sup>2)</sup>	(none) <sup>2)</sup>
<ul style="list-style-type: none"> <li>• Codec (Hi-MD)<sup>2)</sup></li> <li>• (none) (MD)<sup>2)</sup></li> </ul>	<ul style="list-style-type: none"> <li>• Track mode, and bitrate (Hi-MD)<sup>2)</sup></li> <li>• Track mode (MD)<sup>2)</sup></li> </ul>	<ul style="list-style-type: none"> <li>• "Codec" (Hi-MD)<sup>2)</sup></li> <li>• "TrackMode" (MD)<sup>2)</sup></li> </ul>

<sup>1)</sup> Track number appears if the currently selected track is not in a group.

<sup>2)</sup> This does not appear when "Menu Mode" is set to "Simple" (page 52).

<sup>3)</sup> The disc name appears when the currently selected track is not in a group.

## Note

Depending on the group settings, the operating conditions, and the disc settings, you may not be able to select certain indications or the indications may appear differently.



If you want to check the remaining time or the recording position while recording or in stop mode, see “Viewing various information” (page 25).

## Selecting the play mode

You can listen to tracks in various play modes. The play mode can consist of a combination of Main play mode, Sub play mode and Repeat play.

- Main play mode: selects the playback unit, such as tracks or groups
- Sub play mode: selects the type of play
- Repeat play: selects Repeat play

5-way control key (▶ENT, ◀◀, ▶▶)

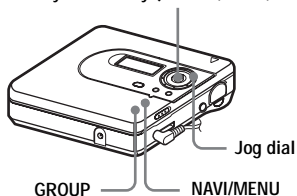

## Playing tracks in Main play mode

- 1 While playing, press NAVI/MENU. The recorder enters navigation mode and the Main play mode display appears.
- 2 Turn the jog dial to select the desired play mode, and then press ▶ENT to enter the selection. Each time you turn the jog dial, **A** changes as follows. When you press ▶ENT, **B** appears in the display.

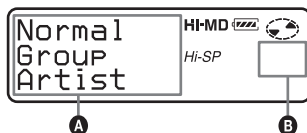

Indication <b>A/B</b>	Play mode
Normal/ (none)	Normal play (All tracks after the selected track are played once.)
Group/	Group play (Tracks in the selected group are played.)
Artist/ <sup>1)</sup>	Artist play (Tracks of a specified artist are played.)
Album/ <sup>1)</sup>	Album play (Tracks in a specified album are played.)
Bookmark/ 	Bookmark play (Bookmarked tracks are played.)

<sup>1)</sup> Appears only for discs used in Hi-MD mode.

## Playing tracks in normal mode (Normal Play)

- 1 Do step 1 and select “Normal” in step 2 of “Playing tracks in Main play mode” (page 34).
- 2 When selecting a track out of a group, skip this step.  
When selecting a track within a group, turn the jog dial until the group that the desired track belongs to appears in the display, and then press ►ENT to enter.  
A list of the tracks in the selected group appears in the display.
- 3 Turn the jog dial until the desired track appears in the display, and then press ►ENT to enter the selection.  
The selected track starts playing. The recorder plays from the selected track to the last track in the disc.

## Playing tracks in a group (Group Play)

- 1 Do step 1 and select “Group” in step 2 of “Playing tracks in Main play mode” (page 34).  
A list of the groups on a disc appears.
- 2 Turn the jog dial until the desired group appears in the display, and then press ►ENT to enter.  
A list of the tracks in the selected group appears.
- 3 Turn the jog dial until the desired track appears in the display, and then press ►ENT to enter the selection.  
The name of the group to which current track belongs appears in the display. The recorder plays the tracks in that group, from the current track to the last track.



You can cue to the start of a group. While playing, press GROUP on the recorder, and press the 5-way control key towards ◀◀ or ▶▶ to select a desired group.

## Listening to tracks by a specific artist (Artist Play) (in Hi-MD mode only)

If the track data includes the artist name, you can listen to tracks by a specific artist only.

- 1 Do step 1 and select “Artist” in step 2 of “Playing tracks in Main play mode” (page 34).  
A list of the artists on the disc appears in alphabetical order.
- 2 Turn the jog dial until the desired artist name appears in the display, and then press ►ENT to enter.  
A list of the tracks of the selected artist appears in recorded order.
- 3 Turn the jog dial until the desired track appears in the display, and then press ►ENT to enter the selection.  
The name of the artist of the current track appears in the display. The recorder plays the tracks by the same artist on the disc, from the current track to the last track.



You can cue to the first track of the next or previous artist. While playing, press GROUP on the recorder, and press the 5-way control key towards ◀◀ or ▶▶.

Listening to tracks of a selected album (Album Play) (in Hi-MD mode only)

If the track data includes the album name, you can listen to tracks of a selected album only.

- 1 Do step 1 and select “Album” in step 2 of “Playing tracks in Main play mode” (page 34).

A list of the albums on the disc appears in alphabetical order.

- 2 Turn the jog dial until the desired album name appears in the display, and then press ►ENT to enter.

A list of the tracks in the selected album appears in recorded order.

- 3 Turn the jog dial until the desired track appears in the display, and then press ►ENT to enter the selection.

The name of the album to which the current track belongs appears in the display. The recorder plays the tracks in that album, from the current track to the last track.



You can cue to the first track of the next or previous album. While playing, press GROUP on the recorder, and press the 5-way control key towards ◀◀ or ▶▶.

Listening to selected tracks only (Bookmark Play)

You can bookmark tracks on a disc and play them only. The sequence of bookmarked tracks cannot be changed.

### To bookmark the tracks

- 1 While playing the track you want to bookmark, press ►ENT for 2 seconds or more.

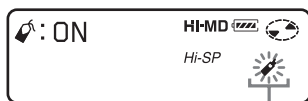

Bookmark flashes.

The first track of the bookmark play is set.

- 2 Repeat step 1 to bookmark the other tracks.

### To play the bookmarked tracks

- 1 Do step 1 and select “Bookmark” in step 2 of “Playing tracks in Main play mode” (page 34).
- 2 Turn the jog dial to select a track, and then press ►ENT to enter the selection.

The recorder plays the bookmarked tracks in the order of their track numbers.

### To erase bookmarks

While playing the track for which you want to erase the bookmark, press ►ENT for 2 seconds or more.

## Playing tracks in Sub play mode/Repeat play

By specifying Sub play modes, you can listen to tracks selected in Main play mode in various ways.

For example, by selecting “Group” in Main play mode and “Shuffle” in Sub play mode, the recorder will play the tracks in the selected group in random order.

- 1 Enter the menu and select “SubPMode”.
- 2 Turn the jog dial to select the desired play mode, and then press ►ENT to enter the selection.

Each time you turn the jog dial, **A** changes as follows. When you press ►ENT, **B** appears in the display.

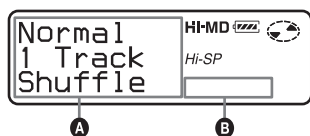

Indication <b>A/B</b>	Play mode
Normal/(none)	Normal play (All tracks are played once.)
1 Track/1	Single-track play (A single track is played.)
Shuffle/SHUF	Shuffle play (All tracks in the selected Main Play Mode are played in random order.)
A-BRepeat/ A- (A-B ◀ ) <sup>1)</sup>	A-B Repeat play (Tracks between the selected points A and B are played repeatedly.)

<sup>1)</sup> “A-BRepeat ” does not appear when the “Menu Mode” is set to “Simple”.

- 3 Turn the jog dial until “RepeatOn” (playing a track repeatedly) or “RepeatOff” appears in the display, and then press ►ENT to enter the selection (except when selecting A-B Repeat play).

### Listening to a section of a track repeatedly (A-B Repeat)

You can listen to a specific section within a track repeatedly by selecting the starting point A, and ending point B. Make sure that points A and B are within the same track.

- 1 While playing a track that contains the section you want to repeat, enter the menu and select “SubPMode” - “A-BRepeat”. “A-” flashes in the display.
- 2 Press ►ENT at the starting point (A). Point A is entered and “B” flashes in the display.
- 3 Press ►ENT at the ending point (B). Point B is entered, “A-B” and “◀” lights up, and the section between point A and B starts playing repeatedly.



You can reset points A and B by pressing the 5-way control key towards ►► during A-B Repeat play.

#### Note

If the recorder come to the end of the last track on the disc while you are selecting point A, the setting is canceled.

## Searching for a track (Search)

You can easily search for a track by track name, group name, artist name, or album name. Artist names and album names can be viewed in the case of discs used in Hi-MD mode only.

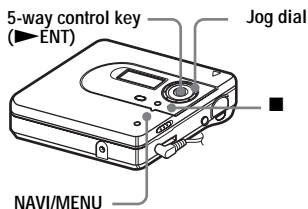

- 1 Enter the menu and select “Useful” - “Search”.
- 2 Turn the jog dial to select the item you want to use for searching, and then press ▶ENT to enter.

Display	To
by Track	search by track name
by Group	search by group name
by Artist <sup>1)</sup>	search by artist name
by Album <sup>1)</sup>	search by album name

<sup>1)</sup> Appears only for discs used in Hi-MD mode.

- 3 If you select “by Track” in step 2, skip this step.  
If you select an item other than “by Track” in step 2, turn the jog dial to select the desired group, artist, or album, and then press ▶ENT to enter.  
A list of tracks for the selected group, artist, or album appears in the display.

- 4 Turn the jog dial to select the desired track, and then press ▶ENT to enter the selection.

The selected track starts playing.

### Notes

- After step 4, Main play mode and Sub play mode will be canceled (Repeat play will function).
- During a search, unlabeled tracks will appear at the end of each list.
- While the recorder is sorting the selected items, “SORTING” appears in the display. Wait until this indication disappears from the display before doing any operation.

## Selecting the sound quality (6-Band Equalizer)

6-BAND EQUALIZER provides 6 different sound qualities. You can vary the virtual sound to create different acoustics, or modify the sound to suit your taste and store it for later use.

5-way control key (▶ENT, ◀◀, ▶▶)

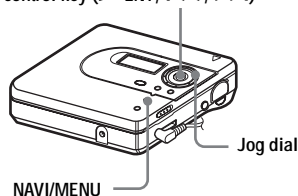

- 1 While playing, enter the menu and select “Sound” - “Sound EQ”.

- 2 Turn the jog dial repeatedly to select the sound mode and then press **▶ENT** to enter the selection.

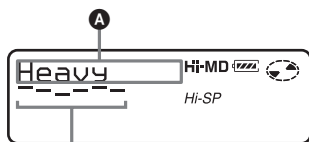

Level of each frequency  
(100Hz - 10 kHz)

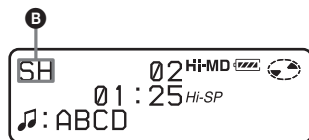

Each time you turn the jog dial, **A** changes as follows. When you press **▶ENT**, **B** appears.

<b>A</b>	<b>B</b>
Heavy	SH
Pops	SP
Jazz	SJ
Unique	SU
Custom1	S1
Custom2	S2

To modify and store the sound  
You can modify the sound and store the results in “Custom1” and “Custom2”.

- 1 While the recorder is playing, enter the menu and select “Sound” - “Sound EQ” - “Custom1” or “Custom2”.
- 2 Press the 5-way control key towards **◀◀** or **▶▶** to select the frequency.

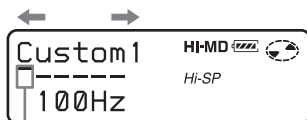

Frequency (100 Hz)  
From the left, you can select 100 Hz, 250 Hz, 630 Hz, 1.6kHz, 4 kHz, 10 kHz

- 3 Turn the jog dial to adjust the level.

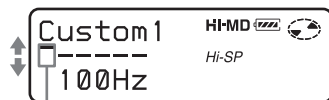

Level (+10 dB)  
You can select from among seven levels.  
-10dB, -6 dB, -3 dB, 0 dB, +3 dB, +6 dB, -10dB

- 4 After selecting the level, press **▶ENT** to enter the selection.

To cancel the setting  
Select “Normal” in step 1.

#### Note

6-Band Equalizer will not function during recording.

## Before editing

You can edit your recordings by adding/erasing track marks or labeling tracks and discs.

### Notes

- When you edit the contents of a 1GB Hi-MD disc, use a new alkaline dry battery (battery level indication shows ) or connect the optional AC power adaptor to the recorder. When you attempt to edit on a 1GB Hi-MD disc, “NotENOUGH POWER TO EDIT” may appear and editing cannot be done even if the battery level indication shows sufficient remaining power while the recorder is stopped or playing. This is because of a mechanism that disables editing when the remaining battery power is estimated by the recorder to be insufficient due to the high power consumption required for 1GB Hi-MD disc editing.
- Before making an editing while using the optional AC power adaptor, always insert a new alkaline dry battery into the recorder first to ensure that the editing operation completes successfully.
- Premastered discs cannot be edited.
- Close the record-protect tab on the side of the disc before editing
- Do not move or jog the recorder or disconnect the power source while editing or “SYSTEM FILE WRITING” is flashing in the display. If you do, the data edited up to that point may not be recorded to the disc, or data on the disc may be damaged. “SYSTEM FILE WRITING” flashes while the editing results are being recorded.
- While “SYSTEM FILE WRITING” is flashing, the lid becomes locked.

## Adding titles (Title)

You can add titles to tracks, groups and discs. You can add artist names and album names to tracks on a disc used in Hi-MD mode.

### Available characters

- Capital and small letters of the alphabet for English and European languages<sup>1)</sup>
- Numbers 0 to 9
- Symbols<sup>2)</sup>

<sup>1)</sup> European alphabets appear only for discs used in Hi-MD mode.

<sup>2)</sup> The available symbols will differ for Hi-MD mode and MD mode (see “About the character palette” on page 41).

### Maximum number of characters per name

Track names, group names, and disc name: Approx. 200 each (containing a mixture of all available characters)

### Maximum number of characters that can be input per disc

In Hi-MD mode:

A maximum of about 55,000 characters

In MD mode:

A maximum of about 1,700 characters

The number of titles that can be stored on a disc depends on the number of characters that are input for track names, group names, artist names, album names and disc name.



## About the character palette

During operations on the recorder, characters can be selected from the character palette in the display. The character palette has the following configuration.

Character palette for Hi-MD mode

ABCDEFGHI  
JKLMNOPQR  
STUVWXYZ  
abcdefghijklmnop  
ijklmnopqr  
stuvwxyz  
012345678  
9?!" ' , . : ;  
( ) { } [ ] < > &  
À Á Â Ã Ä Å Æ Ç È  
É Ê Ë Ì Í Î Ï Ñ  
Ò Ó Ô Õ Ö Ù Ú Û  
Ü Ý Þ ß à á â ã  
ä å ç è é ê ë ì  
í î ï ð ñ ò ó ô õ  
ö ù ú û ü ý ÿ  
ÿ ÿ ÿ ÿ ÿ ÿ ÿ ÿ  
± \* % \$ + - \* /  
\ @ # \$ % & ' ( ) \*  
1 2 3 4 5 6 7 8 9 0  
1 2 3 4 5 6 7 8 9 0  
1 2 3 4 5 6 7 8 9 0

Character palette for MD mode

ABCDEFGHI  
JKLMNOPQR  
STUVWXYZ  
abcdefghijklmnop  
ijklmnopqr  
stuvwxyz  
012345678  
9?!" ' , . : ;  
( ) & % \$ + - \* /  
=<>@#`\_

## Note

If you enter the symbol “/” between the characters in disc names such as “abc//def”, you may be unable to use the group function (in MD mode only).

5-way control key

(▶ENT, ◀◀, ▶▶, VOL +, -)

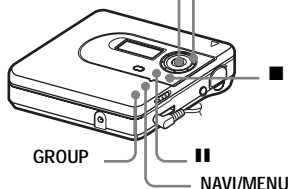

## Labeling

You can label a track, group, or disc while the recorder is stopped, recording or playing. You can also label artist names and album names to tracks in a disc used in Hi-MD mode. Note that if you label a track name, an artist name, or an album name to a track while the recorder is stopped, the track must be the currently selected.

You can label a group while the recorder is recording or playing a track in the group, or while a track in the group is selected and the recorder is stopped.

- 1 Enter the menu and select “Edit” - “Title”.

## Letter input area

The cursor flashes.



Character palette

Since only a part of the character palette is visible on the display, use the controls or buttons to move the cursor and enter characters.

- 2 Select one of the following, and then press the jog dial.

Title	Display
Track name	"Track"
Group name	"Group"
Artist name (to a track) <sup>1)</sup>	"Artist"
Album name (to a track) <sup>1)</sup>	"Album"
Disc name	"Disc"

- <sup>1)</sup> Appears only for discs used in Hi-MD mode.

The cursor flashes in the letter input area to the character palette.

The cursor and character alternate.



- 3 Press the 5-way control key towards VOL -.

The cursor shifts from the letter input area to the character palette.

The cursor and character alternate.



- 4 Select a letter using the 5-way control key and press ►ENT to enter.

The selected letter appears in the letter input area and the cursor moves to the next input position.

The cursor flashes at the next input position.

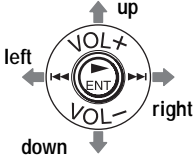

The buttons used for character input and their functions are listed below.

Functions <sup>1)</sup>	Operations
To move the cursor in the character palette.	5-way control key  Turn the jog dial (move the cursor to the right or left).
To select a letter in the letter input area.	Turn the jog dial.
To enter a letter.	Press ►ENT.
To enter a title.	Press ►ENT for 2 seconds or more.
To insert a blank space.	Press GROUP and press the 5-way control key towards ►► at the same time.
To delete a letter.	Press GROUP and press the control key towards ◀◀ at the same time.
To cancel labeling.	Press ■ for 2 seconds or more.
To move the cursor from the letter input area to the character palette.	Press the 5-way control key towards VOL -.
To move the cursor from the character palette to the letter input area.	Press ■.
To display " " (space), ":", "/" or "-" at the input position in the letter input area.	Press ■.
To switch between capital letters and small letters.	Press ■.

<sup>1)</sup> Functions of the buttons or the control may differ depending on when the cursor is in the letter input area or in the character palette.

5 Repeat step 4, and then enter all characters of the label name.

6 Press ►ENT for 2 seconds or more.

### Note

When the recording is stopped or the recording moves on to the next track while labeling titles during recording, the input at that point is entered automatically.

## Re-labeling

You can change the track name, artist name, album name, group name, or disc name by doing the procedure for “Labeling” (page 41).

### To re-label a track name, artist name, or album name:

Start playing the track you want to re-label, and then change the track name, artist name, or album name while the recorder is playing, or while the recorder is stopped and the track to be re-labeled is currently selected.

### To re-label a disc:

You can re-label the disc while the recorder is stopped, recording, or playing.

### Notes

- The recorder is able to display, but cannot label using Japanese “Katakana” characters.
- The recorder cannot rewrite a disc or track name of more than 200 letters that was created by another device (in MD mode only).

## Assigning tracks or groups as a new group (Group Set)

With this function, you can assign existing tracks or groups to a new group, and also you can assign a track that currently belongs to no group to an existing group.

You can create a maximum of 255 groups on a Hi-MD disc or a standard disc in Hi-MD mode and 99 groups on a standard disc.

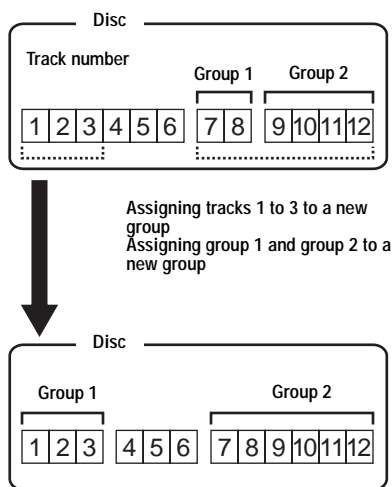

Registration of non-consecutive tracks is not possible (for example, track 3 and tracks 7 and 8 cannot be assigned to a new group).

It is not possible to make a new group if the first track or last track of the group has been selected from the middle of an existing group.

Track numbers appear according to their order on the disc, not their order within the group.

## Notes

- When the total number of characters in the titles on a disc exceed the maximum that can be input:
  - If the disc is being used in Hi-MD mode, you can make a group setting, but cannot add a group name in step 4.
  - If the disc is being used in MD mode, you cannot make a group setting.
- The tracks or groups must be sequential. If the desired tracks or groups are not consecutive, you must move them to make them consecutive before you can assign them (“Moving recorded tracks or groups (Move)”, page 45).

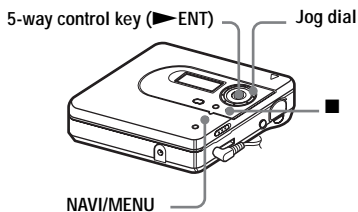

- 1 Enter the menu and select “Edit” - “ : Set”.
- 2 Turn the jog dial until the number of the desired first track appears in the display, and then press ▶ENT to enter.

This selects the first track of a new group. If the disc contains groups, only the first track number of each group is displayed.

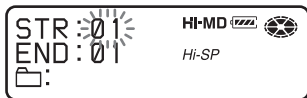

- 3 Turn the jog dial until the number of the desired last track appears in the display, and then press ▶ENT to enter.

This selects the last track of the new group and the group can be labeled. If the disc contains groups, only the last track number of each group is displayed.

- 4 Label a group (see “Adding titles (Title)” (page 40)).

## Notes

- In step 2, the first track must be either the first track of an existing group or a track that does not belong to a group.
- When selecting the last track in step 3, make sure the track comes after the one selected in step 2. The last track must be either the last track of an existing group or a track that does not belong to a group.

## Releasing a group setting (Group Release)

Select a group you want to release and check the contents (see “Playing tracks in a group (Group Play)” (page 35)).

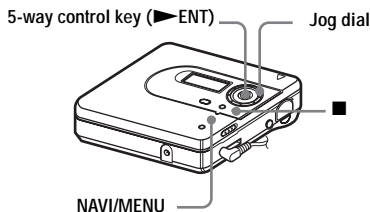

- 1 Select a group that you want to release and check the contents (see (page 35)).
- 2 Press .

- 3 Enter the menu and select “Edit” - “ : Release”.  
“Group Release?” and “PUSH YES:ENTER NO:CANCEL” appear alternately in the display.

- 4 Press ENT to release a group.  
The group setting of the selected group is released.

## Moving recorded tracks or groups (Move)

You can change the order of the recorded tracks or groups.

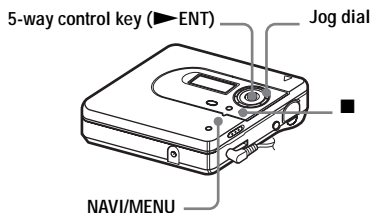



## Changing the order of a track on a disc

When you move tracks, track numbers are automatically renumbered.

### Example

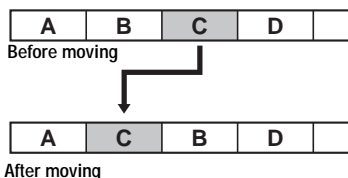
Move track C (track number 3) from the third to the second track.



- 1 While playing the track you want to move, enter the menu and select “Edit” - “Move” - “ : Move”.  
The selected track number appears in the display.



- 2 Turn the jog dial until the destination track number flashes in the display.  
For the example, since track C will be moved to track “02”, turn the jog dial until “02” appears in the display.

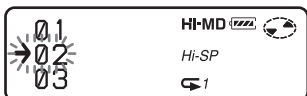

- 3 Press ENT to enter the selection.  
The track moves to the selected destination track.

## Moving a track in a disc with group setting

You can move a track from one group out of the group or to another group. You can also move a track that does not belong to a group to an existing group.

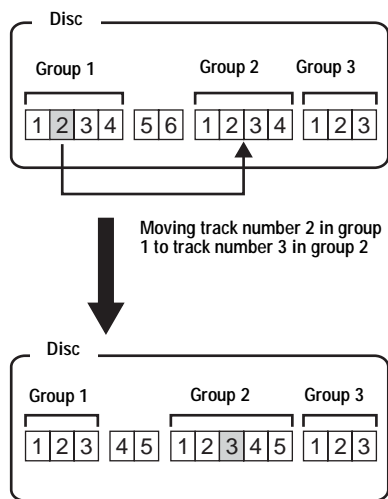

- 1 Do step 1 of “Changing the order of a track on a disc” (page 45).
- 2 When moving a track out of a group, skip this step. When moving a track to a different group, turn the jog dial until the destination group appears in the display, and then press **▶ENT**.

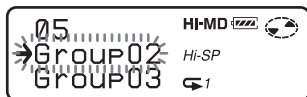

- 3 Turn the jog dial until the destination track number appears in the display, and then press **▶ENT** to enter the selection.

Example: When moving the track to the track number “03” in the second group (GP02).

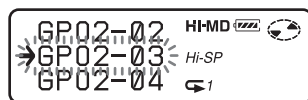

## Changing the order of a group on a disc

- 1 While playing a track within a group whose order you want to change, enter the menu and select “Edit” - “Move” - “ : Move”. The group number to which the currently playing track belongs appears in the middle row of the display.
- 2 Turn the jog dial to select the destination point on the disc, and then press **▶ENT** to enter the selection.

Example: Moving the first group in the disc (Group01) to the position between the second (Group02) and the third (Group03) group.

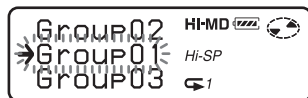

If the track or group has been labeled, press the 5-way control key towards **▶▶** to make the track or group name appear in the display during operation. Press the control key towards **◀◀** to return to the track or group number display.

### Note

If all tracks are moved out of the group, the group automatically disappears from the disc.

## Erasing tracks and the entire disc (Erase)

You can erase unnecessary tracks or all tracks on a disc.

When erasing tracks that have been transferred from the computer

If you erased tracks that have been transferred from the computer, the transfer authorization of the tracks will be as follows.

- If the tracks were transferred in Hi-MD mode, the transfer authorization of the tracks are restored automatically when you insert the disc into the recorder and then connect the recorder to the computer.
- If the tracks were transferred in MD mode, the transfer authorization of the tracks is lost. If you do not want to lose the transfer authorization, restore the authorization by transferring the tracks to the computer again before erasing them.

### Note

You cannot erase non-audio data (for example, text data or image data) on a disc used in Hi-MD mode.

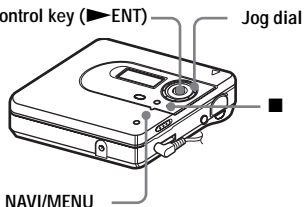

## To erase a track

**Note that once a recording has been erased, you cannot retrieve it. Make sure of the track you are erasing.**

- 1 While playing the track you want to erase, enter the menu and select “Edit” - “Erase” - “ : Erase”. “Erase OK?” and “PUSH YES:ENTER NO:CANCEL” appear in the display. If the selected track was transferred from the computer, “TrkFromPC ERASE OK?” appears in the display.

- 2 Press ENT to erase the track. The track is erased and the next track starts to play. All the tracks after the one erased are automatically renumbered.

### Note

If all tracks in a group are erased, the group is automatically deleted from the disc.



To erase a part of a track

Add track marks at the beginning and the end of the part you want to erase, then erase the part (page 49).

## To erase a group

You can erase tracks in a selected group. **Note that once a recording has been erased, you cannot retrieve it. Be sure to check the contents of the group before you erase it.**

- 1 Select a group you want to erase and check the contents (see page 35).
- 2 Press .

- 3 Enter the menu and select “Edit” - “Erase” - “ : Erase”.  
“Group Erase OK?” and “PUSH YES:ENTER NO:CANCEL” appear in the display.  
If the selected group contains tracks that have been transferred from the computer, “TrkFromPC ERASE OK?” appears in the display.
- 4 Press ENT to erase the group.  
The group is erased.

### To erase the whole disc

You can quickly erase all the tracks and data of the disc at the same time.

**Note that once a recording has been erased, you cannot retrieve it. Be sure to check the contents of the disc before you erase it.**

In case of a Hi-MD disc or standard disc in Hi-MD mode, only audio data is erased. Other data such as text or image data will not be erased.

- 1 Play the disc you want to erase to check the contents.
- 2 Press .
- 3 Enter the menu and select “Edit” - “Erase” - “AllErase”.  
“ALL TRACK Erase OK?” and “PUSH YES:ENTER NO:CANCEL” appear in the display.  
If the disc contains tracks that have been transferred from the computer, “TrkFromPC ERASE OK?” appears in the display.

- 4 Press ENT to erase the whole disc.  
“SYSTEM FILE WRITING” appears in the display, and all the tracks will be erased.  
When erasing completes, “NO TRACK” appears in the display in Hi-MD mode and “BLANKDISC” and “00:00” appear in MD mode.



## Dividing a track (Divide)

You can divide a track with a track mark, creating a new track from the part following the track mark. The track numbers will increase as follows.

### Notes

- You cannot add a track mark on a track that has been transferred from your computer.
- You cannot divide a track that has been recorded in Hi-MD mode using the MD Simple Burner software.
- The Bookmark setting will be erased if you carry out the Divide function.
- You cannot divide a track at its beginning or end.
- You cannot divide a track if after the division causes the total number of tracks on the disc to exceed the maximum allowed (2,047 tracks for a disc used in Hi-MD mode or 254 tracks for a standard disc).

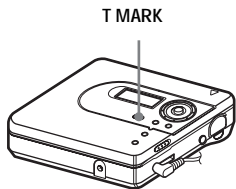
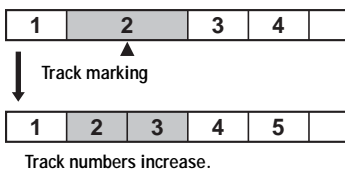

## Dividing a track directly

While playing or pausing, press T MARK on the recorder at the point you want to mark. "MARK ON" appears in the display, and a track mark is added. The track number will increase by one.

To add track marks while recording (except while synchro-recording)

Press T MARK at the point you want to add a track mark.

You can use Time Mark to add track marks automatically at specified intervals (except while digital recording) (page 29).

## Combining tracks (Combine)

When you record with analog (line) input, unnecessary track marks may be recorded where recording level is low. You can erase a track mark to combine the tracks before and after the track mark. The track numbers will change as follows.

### Notes

- You cannot erase a track mark on a track that has been transferred from your computer.
- You cannot erase a track mark on a track that has been recorded in Hi-MD mode using the MD Simple Burner software.
- You cannot combine tracks recorded in different recording mode.

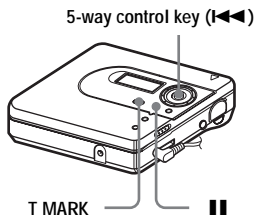
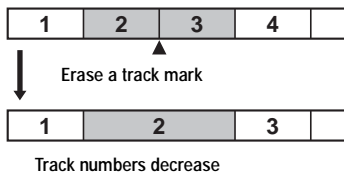

1 While playing the track with the track mark you want to erase, press **II** to pause.

2 Find the track mark by pressing the 5-way control key towards **◀◀** slightly.

For example, to erase the third track mark, find the beginning of the third track. “00:00” appears in the display. “MARK” appears in the display for a few seconds.

3 Press **T MARK** to erase the mark. “MARK OFF” appears in the display. The track mark is erased and the two tracks are combined.



When a track mark is erased when you combine two tracks, the recording date and title of the second track changes to those of the first track.

#### Note

When you erase a track mark between the two consecutive tracks that are assigned into different groups, the second track is re-assigned into the group containing the first track. In addition, if you combine a track that is assigned to a group with a track that is not assigned to a group (two consecutive tracks), the second track takes the same registration setting as the first track.

## Formatting the disc (Format)

When using a disc in Hi-MD mode, you can use the Format function to restore a disc to the condition it was in at the time of purchase.

You can use this function only when using a disc in Hi-MD mode.

Disc type	After performing the Format function
1GB Hi-MD disc	“NO TRACK” appears. All data including non-audio data will be erased.  <b>NOTE:</b> Transfer authorization of the transferred tracks can be restored by connecting the recorder with the disc inserted to the computer.
60/74/80-minute standard disc	“BLANKDISC” appears. All data including non-audio data will be erased. You can then use the disc again in either MD mode or Hi-MD mode.  <b>NOTE:</b> Transfer authorization of the transferred tracks will be decreased by one.

#### Notes

- By formatting a disc, all data (including non-audio data) will be erased. If you think a disc contains such data, insert the disc into the recorder and connect the recorder to the computer to check the contents of the disc.
- If you format a disc, the transferred tracks on the disc will also be erased and the number of transfer authorizations for those tracks will be decreased by one. To prevent the reduction in transfer authorizations, restore the transfer authorization by transferring the tracks to the computer again before formatting the disc.
- The operation mode set in the “Disc Mode” menu is applied to a blank 60/74/80-minute standard disc used on the recorder even if a different operation mode was selected in the SonicStage software or a different operation mode appeared on the display after the disc was formatted by the SonicStage software.

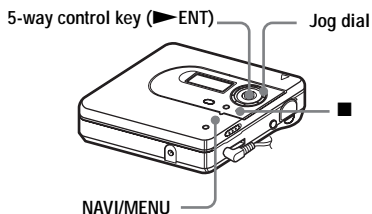

- 1 While the recorder is stopped, enter the menu and select “Edit” - “Format”.
- 2 Turn the jog dial until “YES” appears in the display, and then press ▶ENT to enter the selection.

When formatting completes, “NO TRACK” appears in the display if a 1GB Hi-MD disc is inserted in the recorder, or “BLANKDISC” appears if a standard disc in Hi-MD mode is inserted.

### Changing the displayed menu items (Menu Mode)

You can specify the display of all items in the menu (Advanced mode) or only basic items (Simple mode).

Refer to “List of menus” (page 22) to check the menu items that cannot be displayed.

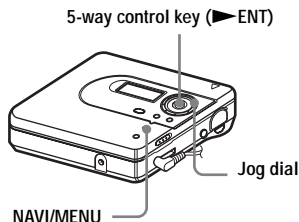

- 1 Enter the menu and select “Option” - “Menu Mode”.
- 2 Turn the jog dial until “Simple” or “Advanced” appears in the display, and then press ▶ENT to enter the selection.

### Protecting your hearing (AVLS)

The AVLS (Automatic Volume Limiter System) function keeps down the maximum volume to protect your ears.

5-way control key (▶ENT)

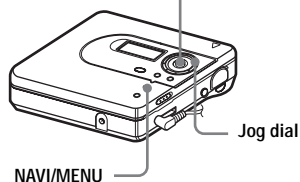

- 1 Enter the menu and select “Option” - “AVLS”.
- 2 Turn the jog dial until “AVLS On” appears in the display, and then press ▶ENT to enter the selection.  
When you try to turn the volume too high, “AVLS NO VOLUME OPERATION” appears in the display. The volume is kept to a moderate level.

To cancel the AVLS  
Select “AVLS Off” in step 2.

## Turning off the beep sound

You can turn off/on the beep sound.

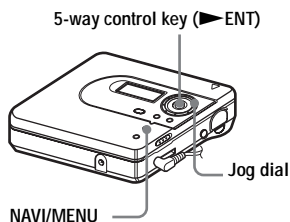

- 1 Enter the menu and select "Option" - "Beep".
- 2 Turn the jog dial until "Beep Off" appears in the display, and then press ▶ENT to enter the selection.

To turn on the beep sound  
Select "Beep On" in step 2.

## Storing the settings for individual discs (Disc Memory)

The recorder is factory set to automatically store settings for each disc. The recorder automatically stores the settings for a disc and retrieves them whenever the disc is inserted.

The following setting can be stored:

- Bookmark
- "Custom1" and "Custom2" settings of 6-Band Equalizer

You can check the setting as follows.

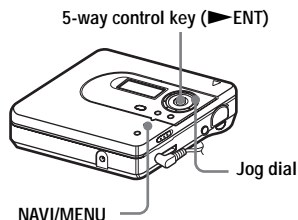

- 1 Enter the menu and select "Option" - "Disc Mem".
- 2 Turn the jog dial until "On" appears in the display, and then press ▶ENT to enter the selection.

To set the recorder so that disc settings are not stored  
Select "Off" in step 2.

## Erasing the disc information

- 1 Insert the disc whose information is to be erased and verify its contents.
- 2 Select "1MemErase" in step 2.  
The disc information is erased.



"Disc Memory" appears when the disc with its setting stored is inserted.

## Notes

- Settings for up to 64 discs can be stored. Any settings stored afterwards will replace the settings with the lowest frequency of use among the 64. The numbers of discs that can be stored depend on the numbers of tracks recorded on the discs. More tracks recorded per disc means fewer discs can be stored.
- If you try to erase the disc information of a disc that have never been stored, “NO DISC MEMORY” appears in the display for a few seconds.

## Starting the playback quickly (Quick Mode)

After pressing the playback button or cueing to the track, the playback can start quickly.

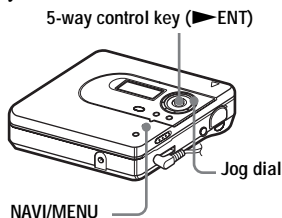

- 1 Enter the menu and select “Option” - “QuickMode”.
- 2 Turn the jog dial until “Quick On” appears in the display, and then press ▶ENT to enter the selection.

To switch back to the normal setting

Selects “Quick Off” in step 2.

## Notes

- When the quick mode is set to “Quick On”, the power remains on within the recorder even when nothing appears in the display. This leads to a shorter battery life.
- If no recorder operation (including opening or closing of the lid) occurs for an hour, the power in the recorder automatically turns off. For this reason, the next time you start playback or do another operation, the recorder will not respond quickly. The unit, however, will return to quick mode afterwards.

## Selecting the disc mode (Disc Mode)

When you insert a 60/74/80-minute standard disc (blank) into the recorder, you can use this function to specify use of the disc in Hi-MD mode or MD mode. If you want to use the disc recorded on this unit on another component that does not support Hi-MD, record the disc with “Disc Mode” in the menu set to “MD”.

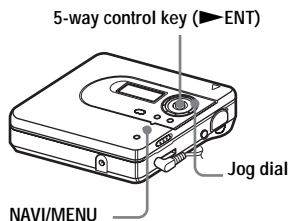

- 1 Enter the menu and select “Option” - “Disc Mode”.
- 2 Turn the jog dial until “Hi-MD” (factory setting) or “MD” appears in the display, and then press ▶ENT to enter the selection.

### Notes

- Even if you select “MD” as the “Disc Mode” setting, the operation mode can only be “Hi-MD” when using a 1GB Hi-MD disc.
- The operation mode set in the “Disc Mode” menu is applied to a blank 60/74/80-minute standard disc used on the recorder even if a different operation mode was selected in the SonicStage software or a different operation mode appeared on the display after the disc was formatted by the SonicStage software.

## Adjusting the contrast of the display window (Contrast Adjustment)

You can adjust the contrast of the display window.

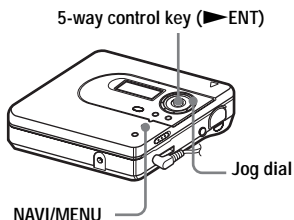

- 1 While the recorder is stopped, enter the menu and select “Option” - “Contrast”.
- 2 Turn the jog dial to adjust the contrast, and then press ▶ENT to enter the selection.

---

## Changing the operational direction of the display

When you turn the jog dial clockwise, the display scrolls downward. This is the factory setting. You can change the factory setting to scroll in the opposite direction.

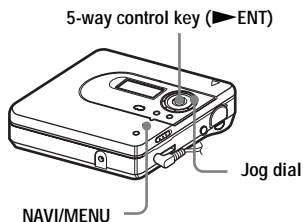

- 1 Enter the menu and select “Option” - “Jog Dial”.
- 2 Turn the jog dial until “Reverse” appears in the display, and then press ▶ENT to enter the selection.

To turn the setting to normal  
Select “Default” in step 2.



### What you can do through connection with a computer

To use the recorder connected to a computer, you must install the software from the supplied CD-ROM. For details on the installation procedure, refer to the “Software Operation” section.

When using the supplied softwares

For detailed explanations, see the “Software Operation” section or online help.

- **Transfer audio data between the computer and the recorder**

The supplied SonicStage software enables you to transfer audio data between the recorder and the computer. When a disc used in Hi-MD mode is inserted in the recorder, tracks recorded from a CD player to the recorder can be migrated to your computer.

- **Record directly from a CD to an MD**

The supplied MD Simple Burner software enables you to record a CD in the computer’s CD drive directly to a disc in the recorder.

When using the disc in the recorder as a storage device

When using a disc in Hi-MD mode, the recorder appears in the Windows Explorer as an external drive, allowing you to transfer non-audio data such as text and image files. For details, refer to “Storing non-audio data to a disc” (page 59).



If you play audio files using the software, the sound is output from the computer speakers during Hi-MD mode and from the headphones/earphones connected to the recorder during MD mode.

### Connecting the recorder to your computer

When you connect the dedicated USB cable directly to the USB connecting jack on the recorder, power (bus power) is supplied from the USB port of the computer. This allows the recorder to be used without power being supplied from the battery.

#### Notes

- **When using Windows 2000 Professional**

Be sure the dedicated USB cable is disconnected before turning on or restarting the computer. If the dedicated USB cable is connected at this time, but then disconnected afterwards, the computer may not recognize the recorder the next time you connect the dedicated USB cable. When the computer does not recognize the recorder, disconnect the dedicated USB cable, restart the computer, and then reconnect the dedicated USB cable. The problem described here may be resolved by updating your Windows operating system so that it contains all the latest features.

- **When using Windows ME or Windows 98SE**

If you connect the recorder to the computer with the disc mode on the recorder set to “Hi-MD” (factory setting), and then insert a 60/74/80-minute standard disc, the operation mode of the disc may automatically change to Hi-MD mode even if you do not record anything.

- **When using Windows ME or Windows 98SE**

When you disconnect the dedicated USB cable, the message “Unsafe Removal of Device” appears in the computer display. This is not a problem. Merely click “OK” to make the message disappear.

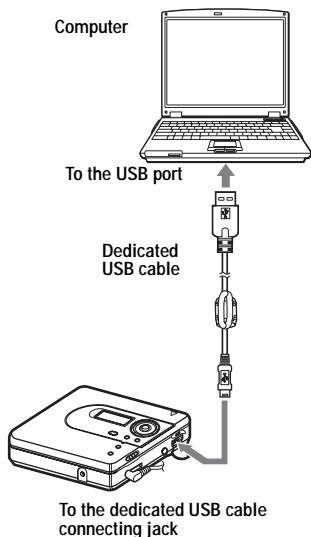

- 1 Insert a recordable disc into the recorder.
- 2 Make connections as follows.
  - ① Connect the dedicated USB cable to the recorder and to the computer.
  - ② Make sure the recorder is stopped and HOLD is released.
- 3 Check the connections.

When the connections have been properly made, “PC -- MD” appears in the display.

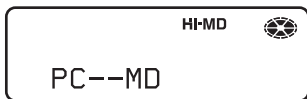

When you unplug the dedicated USB cable from the computer or remove the disc from the recorder

Be sure to remove the recorder or the disc as follows. If not, damage to the data may occur.

- 1 Make sure that “REC” is not displayed in the display window.
- 2 Press **■** on the recorder. “EJECT DISC OK” appears in the display. Depending on the conditions, it may take some time until “EJECT DISC OK” appears in the display.
- 3 Unplug the dedicated USB cable from the computer or remove the disc from the recorder.

#### Notes

- If you use the recorder connected to the computer, it is recommended that you insert a new alkaline dry battery as a precaution against power failures, disconnection of the dedicated USB cable or other unforeseen occurrences. We do not assure the results should there be a mis-operation, transfer failures, or destruction of audio data caused by unforeseen occurrences.
- If you disconnect the dedicated USB cable from the recorder and want to reconnect it, make sure to wait at least 2 seconds before connecting it again.
- Make sure to place the recorder at a stable, vibration-free place during recording.
- Make sure not to connect the recorder to your computer during recording or playing.
- The system may malfunction if your computer changes to system suspend, sleep, or hibernation mode while connecting to the recorder. Make sure to disable any changes to suspend, sleep, or hibernation mode.
- Make sure not to connect the recorder and the computer through a USB hub.
- We do not ensure trouble-free operation on all computers that satisfy the system requirements.

---

## Storing non-audio data to a disc

If you connect the recorder to a computer with a disc in Hi-MD mode inserted, the disc is recognized as storage media by the Windows Explorer, allowing you to store non-audio data such as text data or image data.

For the storage space for each disc, refer to the next page.

When you insert a disc in Hi-MD mode into the recorder and make connection with the computer, the recorder is recognized as an external device and can be viewed on the Windows Explorer. You can use the recorder in the same way as other devices.

### Notes

- When the SonicStage software is active, the recorder is not recognized as a data storage device.
- If you format a disc on the computer, make sure to format the disc using the SonicStage software.
- Make sure not to delete the file management folder (HMDHIFI folder and Hi-MD.IND file) on the Windows Explorer.

The storage space for each disc (formatted with the recorder/the SonicStage software)

<b>Disc type</b>	<b>Total size</b>	<b>Disc management space<sup>1)2)</sup></b>	<b>Free space</b>
60-minute standard disc	219 MB (229,965,824 bytes)	832 KB (851,968 bytes)	218 MB (229,113,856 bytes)
74-minute standard disc	270 MB (283,312,128 bytes)	832 KB (851,968 bytes)	269 MB (282,460,160 bytes)
80-minute standard disc	291 MB (305,856,512 bytes)	832 KB (851,968 bytes)	290 MB (305,004,544 bytes)
Hi-MD disc	964 MB (1,011,613,696 bytes)	832 KB (851,968 bytes)	963 MB (1,010,761,728 bytes)

<sup>1)</sup> This is space that is used for managing the files on the disc.

<sup>2)</sup> The size of the disc management space changes according to the operating conditions of your computer and other factors. Therefore, the actual space available for use may be lower than that displayed by Windows Explorer.

## Precautions

### On safety

Do not put any foreign objects in the DC IN 3V jack (The AC power adaptor is an optional accessory).

### On power sources

- Use house current or LR6 (size AA) battery.
- If you are not going to use this recorder for a long time, be sure to disconnect the power supply.

### On heat build-up

Heat may build up in the recorder if it is used for an extended period of time. This, however, is not a malfunction.

### On installation

- If you use the recorder at a place subject to static or electrical noise, the recording may not be properly done or the recorded data may be lost. If you perform a transfer operation at such a place, the track's transfer authorization may be lost.
- Never use the recorder where it will be subjected to extremes of light, temperature, moisture or vibration.
- Never wrap the recorder in anything when it is being used with the AC power adaptor (not supplied). Heat build-up in the recorder may cause malfunction or damage.

### On the headphones/earphones

#### **Road safety**

Do not use headphones/earphones while driving, cycling, or operating any motorized vehicle. It may create a traffic hazard and is illegal in many areas. It can also be potentially dangerous to play your recorder at high volume while walking, especially at pedestrian crossings. You should exercise extreme caution or discontinue use in potentially hazardous situations.

### **Preventing hearing damage**

Avoid using headphones/earphones at high volume. Hearing experts advise against continuous, loud and extended play. If you experience a ringing in your ears, reduce the volume or discontinue use.

### **Caring for others**

Keep the volume at a moderate level. This will allow you to hear outside sounds and to be considerate of the people around you.

### On the MiniDisc cartridge

- When carrying or storing the MiniDisc, keep it in its case.
- Do not break open the shutter.
- Do not place the cartridge where it will be subject to light, extreme temperatures, moisture or dust.
- Attach the supplied disc label only in the space designated for it on the disc. Do not stick it on any other disc surface.

### On cleaning

- Clean the recorder casing with a soft cloth slightly moistened with water or a mild detergent solution. Do not use any type of abrasive pad, scouring powder or solvent such as alcohol or benzene as it may mar the finish of the casing.
- Wipe the disc cartridge with a dry cloth to remove dirt.
- Dust on the lens may prevent the unit from operating properly. Be sure to close the disc compartment lid after inserting or ejecting a disc.
- To obtain the best sound quality, use a dry cloth to wipe the plugs of the headphones/earphones. Dirty plugs may cause sound distortion or intermittent breaks in the sound.

## On battery

Incorrect battery usage may lead to leakage of battery fluid or bursting battery. To prevent such accidents, observe the following precautions:

- Install the + and – poles of the battery correctly.
- When the recorder is not to be used for a long time, be sure to remove the battery.
- If a battery leak should develop, carefully and thoroughly wipe away battery fluid from the battery compartment before inserting new ones.

## On mechanical noise

The recorder gives off mechanical noise while operating, which is caused by the power-saving system of the recorder and it is not a problem.

## To protect a recorded disc

To record-protect a disc, slide open the tab at the side of the disc. In this position, the disc cannot be recorded. To record again, slide the tab back so the tab is visible.

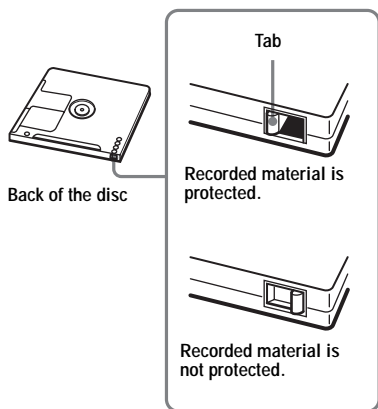

If you have any questions or problems concerning your recorder, please consult your nearest Sony dealer. (If a trouble occurred when the disc was in the recorder, we recommend that the disc be left in the recorder when you consult your Sony dealer so that the cause of trouble may be better understood.)

# Specifications

## Audio playing system

MiniDisc digital audio system

## Laser diode properties

Material: GaAlAs

Wavelength:  $\lambda = 790$  nm

Emission duration: continuous

Laser output: less than 44.6  $\mu$ W

(This output is the value measured at a distance of 200 mm from the lens surface on the optical pick-up block with 7 mm aperture.)

## Recording and playback time (Refer to page 79 for details)

When using HMD1G (1GB disc):

Maximum 34 hours in Hi-LP stereo

When using MDW-80 in Hi-MD mode:

Maximum 10 hours and 10 min. in Hi-LP stereo

When using MDW-80 in MD mode:

Maximum 160 min. in monaural

Maximum 320 min. in LP4 stereo

## Revolutions

350 rpm to 3,000 rpm (CLV)

## Error correction

Hi-MD:

LDC (Long Distance Code)/BIS (Burst Indicator Subcode)

MD:

ACIRC (Advanced Cross Interleave Reed Solomon Code)

## Sampling frequency

44.1 kHz

## Sampling rate converter

Input: 32 kHz/44.1 kHz/48 kHz

## Coding

Hi-MD:

Linear PCM (44.1 kHz/16 bit) — PCM  
ATRAC3plus (Adaptive TRansform  
Acoustic Coding 3 plus)

MD:

ATRAC  
ATRAC3 — LP2/LP4

## Modulation system

Hi-MD:

1-7RLL (Run Length Limited)/PRML  
(Partial Response Maximum Likelihood)

MD:

EFM (Eight to Fourteen Modulation)

## Frequency response

20 to 20,000 Hz  $\pm$  3 dB

## Inputs

LINE IN (OPT)<sup>1)</sup>:

stereo mini-jack for analog input

(minimum input level 49 mV)

optical (digital) mini-jack for optical  
(digital) input

## Outputs

: stereo mini-jack

## Maximum output (DC)

Headphones:

3 mW + 3 mW (16  $\Omega$ ) (European models)

5 mW + 5 mW (16  $\Omega$ ) (Other models)

## Power requirements

One LR6 (size AA) alkaline battery

AC power adaptor DC 3V

## Operating temperature

+5° C (+41° F) to +35° C (+95° F)

## Battery operation time<sup>2)</sup>

See "Battery life" (page 14)

## Dimensions

Approx. 83.6  $\times$  28.9  $\times$  77.0 mm (w/h/d)

(3<sup>3</sup>/<sub>8</sub>  $\times$  1<sup>3</sup>/<sub>16</sub>  $\times$  3<sup>1</sup>/<sub>8</sub> in.) (excluding projecting parts and controls)

## Mass

Approx. 101 g (3.6 oz) (the recorder only)

<sup>1)</sup>The LINE IN (OPT) jack is used to connect either a digital (optical) cable or a line (analog) cable.

<sup>2)</sup>Measured in accordance with JEITA.

US and foreign patents licensed from Dolby Laboratories.

Design and specifications are subject to change without notice.

## Optional accessories

### AC power adaptor

AC-ES3010K (Singapore, Australia and New Zealand models)

AC-E30HG (other models)

### Optical Cable

POC-151HG, POC-152HG, POC-MZ1, POC-MZ2, POC-15B, POC-15AB, POC-DA12SP

### Line Cable

RK-G129, RK-G136

MDR-series Stereo Headphones/earphones\*

SRS-series Active Speakers

Recordable MDs MDW-series

Recordable Hi-MD disc

HMD1G

Your dealer may not handle some of the above listed accessories. Please ask the dealer for detailed information about the accessories in your country.

\* When using optional headphones, use only headphones/earphones with stereo mini plugs. You cannot use headphones/earphones with micro plugs.

## When using the optional AC power adaptor:

Before using the AC power adaptor, do the following procedure to attach the clamp filters to the cord of the AC power adaptor. (You must affix the ferrite cores to comply with applicable EMC standards.)

### ① Open the clamp filters.

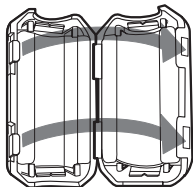

### ② Wind the AC power cord into the clamp filters as shown below.

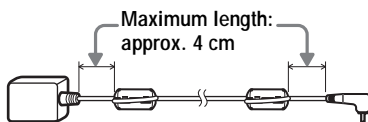
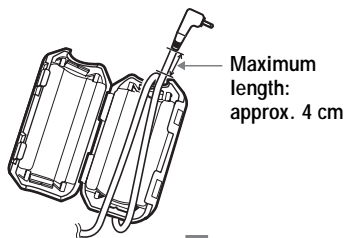

### ③ Close the clamp filters.

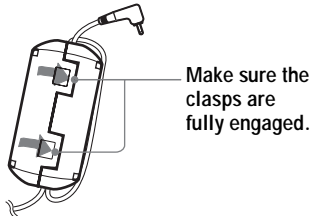





## Troubleshooting

If a problem occurs during recorder operation, follow the steps described below before consulting the nearest Sony dealer. If any messages appear, it is recommended to take notes.

- 1 Check to see if the problem is listed in, “Troubleshooting” (page 65).  
Check “Messages” (page 74) for the problem as well.
- 2 If after step 1 you still cannot solve the problem, consult your nearest Sony dealer.

## While recording

Symptom	Cause/Remedy
“NotENOUGH POWER TO REC” appears and recording cannot be done on a 1GB Hi-MD disc.	<ul style="list-style-type: none"><li>• Recording is not possible when using a 1GB Hi-MD disc even when the battery level indication shows enough power remaining while the recorder is stopped or playing. This is because of a mechanism that disables recording when the remaining battery power is estimated by the recorder to be insufficient due to the high power consumption required for 1GB Hi-MD disc recording. ➔ Insert a new alkaline dry battery or connect the AC power adaptor (not supplied) to the recorder.</li></ul>
The remaining recording time appears as “-0:00:00” and recording cannot be done, even though 2.0MB of free space is displayed.	<ul style="list-style-type: none"><li>• This is a system limitation. 2.0MB is the capacity of the reserve domain.</li></ul>
The recorder always creates a new group when recording.	<ul style="list-style-type: none"><li>• The group recording (“:REC”) is set to “: REC On”. (You cannot overwrite tracks.) ➔ Set the group recording setting to “:REC Off” (page 30).</li></ul>
The first few seconds of a track cannot be recorded.	<ul style="list-style-type: none"><li>• If you start recording while the disc indication is rotating, data will not be recorded to the first few seconds of the first track. ➔ Wait until the disc indication stops rotating before you start recording.</li></ul>

Symptom	Cause/Remedy
Recording cannot be done correctly.	<ul style="list-style-type: none"> <li>• Audio sources may not be securely connected.               <ul style="list-style-type: none"> <li>➔ Disconnect the audio sources once and connect them again (pages 15 and 26).</li> </ul> </li> <li>• There is no digital signal from the portable CD player.               <ul style="list-style-type: none"> <li>➔ When recording digitally from a portable CD player, use the AC power adaptor and disable the anti-skip function (such as ESP) on the CD player (page 18).</li> </ul> </li> <li>• The analog recording was made using a connecting cord with an attenuator.               <ul style="list-style-type: none"> <li>➔ Use a connecting cord without an attenuator.</li> </ul> </li> <li>• Recording level is too small to record (when adjusting the recording level manually).               <ul style="list-style-type: none"> <li>➔ Pause the recorder and adjust the recording level (page 28).</li> </ul> </li> <li>• The recorder is connected to the computer.               <ul style="list-style-type: none"> <li>➔ Disconnect the recorder from the computer when recording.</li> </ul> </li> <li>• The power sources was disconnected or a power outage occurred during recording.               <ul style="list-style-type: none"> <li>➔ The recording result is not recorded on the disc. Make recording again.</li> </ul> </li> <li>• The premastered disc is inserted.               <ul style="list-style-type: none"> <li>➔ Replace to the recordable disc.</li> </ul> </li> <li>• Recording may not be done if the remaining recordable time on the disc is 48 seconds or less (“DISC FULL” appears).               <ul style="list-style-type: none"> <li>➔ Replace the disc.</li> </ul> </li> </ul>
Stereo sound is heard in the headphones/earphones while recording in monaural.	<ul style="list-style-type: none"> <li>• This is normal. During digital recording, the sound will be stereo in the headphones/earphones, even though the recorded sound is monaural.</li> </ul>
Momentary noise is heard when recording.	<ul style="list-style-type: none"> <li>• Due to the special digital audio compression technology used in LP4 stereo mode, momentary noise may occur on very rare occasions with certain sound sources.               <ul style="list-style-type: none"> <li>➔ Record in SP or LP2 mode.</li> </ul> </li> </ul>
The lid does not open after recording.	<ul style="list-style-type: none"> <li>• The lid does not open until “SYSTEM FILE WRITING” disappears in the display.</li> </ul>
“TRACK FULL” appears even before the disc has reached the maximum recording time and the recording cannot be done.	<ul style="list-style-type: none"> <li>• This is due to the MiniDisc system limitation. When 254 tracks (on a standard disc) or 2,047 tracks (on a disc used in Hi-MD mode) have been recorded on the disc, “TRACK FULL” appears regardless of the total recorded time. More than 254 or 2,047 tracks cannot be recorded on the disc.               <ul style="list-style-type: none"> <li>➔ To continue recording, erase unnecessary tracks.</li> </ul> </li> </ul>
The remaining recording time does not increase even after erasing numerous short tracks.	<ul style="list-style-type: none"> <li>• This is due to the MiniDisc system limitation (in MD mode only). Tracks of under 12 seconds (in SP stereo), 24 seconds (in LP2 stereo mode or monaural), or 48 seconds (in LP4 stereo mode) in length are not counted and so erasing them may not lead to an increase in the recording time.</li> </ul>

Symptom	Cause/Remedy
<p>The total recorded time and the remaining time on the disc may not total the maximum recording time (60, 74, or 80 minutes).</p>	<ul style="list-style-type: none"> <li>• This is due to the MiniDisc system limitation (in MD mode only). Normally, recording is done in minimum units of approximately 2 seconds (in SP stereo), 4 seconds (in LP2 stereo mode or monaural), or 8 seconds (in LP4 stereo mode). When recording is stopped, the last unit of recording always uses this unit of 2 seconds, 4 seconds, or 8 seconds even if the actual recording is shorter. Likewise, when recording is restarted after the stop, the recorder will automatically insert a blank space amounting to 2 seconds, 4 seconds, or 8 seconds before the next recording. (This is to prevent accidental erasing of a previous track whenever a new recording is started). Therefore, the actual recording time will decrease whenever a recording is stopped by a maximum of 6 seconds, 12 seconds, or 24 seconds.</li> </ul>
<p>“TRACK FULL” appears even before the disc has reached the maximum track number or recording time.</p>	<ul style="list-style-type: none"> <li>• This is due to the MiniDisc system limitation. Repeated recording and erasing may cause fragmentation and scattering of data. Although those scattered data can be read, each fragment is counted as a track. In this case, the number of tracks may reach 254 (on a standard disc) or 2,047 (on a disc used in Hi-MD mode) and further recording is not possible.  ➡ To continue recording, erase unnecessary tracks.</li> </ul>

## While playing

Symptom	Cause/Remedy
A disc is not played normally.	<ul style="list-style-type: none"> <li>• Repeat play is selected. ➔ Enter the Sub play mode to change back to the normal play (page 37).</li> <li>• Playback mode is changed. ➔ Enter the Main play mode or Sub play mode to change back to the normal play (page 37).</li> </ul>
A disc is not played from the first track.	<ul style="list-style-type: none"> <li>• Disc playing stopped before it came to the last track. ➔ Press the 5-way control key (▶ENT) on the recorder for 2 seconds or more to start playing.</li> </ul>
Playback sound skips.	<ul style="list-style-type: none"> <li>• The recorder is placed where it receives continuous vibration. ➔ Put the recorder on a stable place.</li> <li>• A very short track may cause sound to skip. ➔ Try not to create a short track.</li> </ul>
Sound has a lot of static.	<ul style="list-style-type: none"> <li>• Strong magnetism from a television or such device is interfering with operation. ➔ Move the recorder away from the source of strong magnetism.</li> </ul>
The volume of the recorded track is low.	<ul style="list-style-type: none"> <li>• The track was recorded in analog mode (in digital mode, the recording level is automatically set to the same level as that of the sound source). Or you used a connecting cord with an attenuator. ➔ Use a correct connecting cord without an attenuator.</li> <li>• The recording level was low. ➔ Adjust the recording level manually while recording (page 28).</li> </ul>
Volume cannot be turned up.	<ul style="list-style-type: none"> <li>• AVLS is on. ➔ Release AVLS settings (page 52).</li> </ul>
No sound comes through the headphones/earphones.	<ul style="list-style-type: none"> <li>• The headphones/earphones plug is not firmly connected. ➔ Plug in the plug of the headphones/earphones firmly to ☺.</li> <li>• The plug is dirty. ➔ Clean the plug.</li> </ul>
The disc cannot be played on another component	<ul style="list-style-type: none"> <li>• The component does not support Hi-MD. ➔ Discs used in Hi-MD mode can be played only on components that supports Hi-MD.</li> </ul>
The recorder skips to the next or previous group (or skips several tracks ahead or behind) when you press the 5-way control key towards ◀◀ or ▶▶.	<ul style="list-style-type: none"> <li>• You pressed GROUP before pressing the 5-way control key towards ◀◀ or ▶▶. ➔ The recorder returns to normal if no operation is made for 5 seconds.</li> </ul>
The edited tracks may exhibit sound dropout during search operations.	<ul style="list-style-type: none"> <li>• This occurs due to the MiniDisc system limitation. The fragmentation of data may cause sound dropout while searching because the tracks are played in higher speed than normal playback.</li> </ul>

Symptom	Cause/Remedy
There is no R-channel sound output when playing a track recorded from a cassette deck or through an amplifier, or when listening to sound from a cassette deck or amplifier.	<ul style="list-style-type: none"> <li>• There is no R-channel output if the cassette deck or an amplifier is connected with a monaural cord. <ul style="list-style-type: none"> <li>➔ Make sure to use a stereo connecting cord. If, however, the connected equipment is monaural, there will be no R-channel sound output even with a stereo connecting cord.</li> </ul> </li> </ul>

## While editing

Symptom	Cause/Remedy
“NotENOUGH POWER TO EDIT” appears and editing cannot be done on a 1GB Hi-MD disc.	<ul style="list-style-type: none"> <li>• Editing is not possible when using a 1GB Hi-MD disc even when the battery level indication shows enough power remaining while the recorder is stopped or playing. This is because of a mechanism that disables editing when the remaining battery power is estimated by the recorder to be insufficient due to the high power consumption required for 1GB Hi-MD disc editing. <ul style="list-style-type: none"> <li>➔ Insert a new alkaline dry battery or connect the AC power adaptor (not supplied) to the recorder.</li> </ul> </li> </ul>
The lid does not open.	<ul style="list-style-type: none"> <li>• The power sources have been disconnected during recording or editing, or the battery have been exhausted. <ul style="list-style-type: none"> <li>➔ Set the power sources again, or replace the exhausted battery with new ones.</li> </ul> </li> </ul>
Editing cannot be done.	<ul style="list-style-type: none"> <li>• The power source has been disconnected or a power outage has occurred during editing. <ul style="list-style-type: none"> <li>➔ The editing done to that point is not saved to the disc. Do the editing operation again.</li> </ul> </li> </ul>
Non-audio data cannot be erased.	<ul style="list-style-type: none"> <li>• Non-audio data cannot be erased with the Erase function. <ul style="list-style-type: none"> <li>➔ Confirm the contents by connecting the recorder to your computer. If it is okay to delete the contents, then perform the Format function (page 50).</li> </ul> </li> </ul>

Symptom	Cause/Remedy
Tracks cannot be combined.	<ul style="list-style-type: none"> <li>• This is due to the MiniDisc system limitations. When the tracks are scattered and the length of each track is short*, you may not be able to combine the tracks.</li> <li>* Combining tracks of the following lengths may not be possible.               <ul style="list-style-type: none"> <li>Hi-MD mode                   <ul style="list-style-type: none"> <li>Linear PCM stereo: 9 seconds or less</li> <li>Hi-SP stereo: 8 seconds or less</li> <li>Hi-LP stereo: 32 seconds or less</li> </ul> </li> <li>MD mode                   <ul style="list-style-type: none"> <li>SP stereo: 12 seconds or less</li> <li>LP2 stereo/Monaural: 24 seconds or less</li> <li>LP4 stereo: 48 seconds or less</li> </ul> </li> </ul> </li> <li>• You cannot combine tracks recorded in different recording modes, e.g., a track recorded in stereo and a track recorded in monaural; nor can you combine a track recorded with digital connection and a track recorded with analog connection.</li> </ul>
The disc cannot edit on other component.	<ul style="list-style-type: none"> <li>• The component does not support MDLP or Hi-MD.               <ul style="list-style-type: none"> <li>➔ Edit on other component that support MDLP or Hi-MD.</li> </ul> </li> </ul>

## While using group function

Symptom	Cause/Remedy
The group function does not operate.	<ul style="list-style-type: none"> <li>• While using a disc without group setting, an attempt was made to select some group-related menu. ➡ Use a disc with group setting.</li> </ul>
A track cannot be recorded to a new group. A new group cannot be created.	<ul style="list-style-type: none"> <li>• This is due to the MiniDisc system limitations (in MD mode only). Group information has been written to the area where the disc name is stored. The disc name and track names are recorded in the same area, which can store a maximum of approximately 1,700 characters. If the total number exceeds this amount, a new group cannot be created even though group mode is on. It is also impossible to make group settings at this time.</li> </ul>

## While the recorder is connected to the computer

Symptom	Cause/Remedy
The recorder is not recognized by the computer.	<ul style="list-style-type: none"> <li>• The dedicated USB cable is not firmly connected. ➡ Connect the dedicated USB cable firmly to the recorder and the computer.</li> <li>• A USB hub is used. ➡ Connect the dedicated USB cable directly to the USB port of the computer.</li> <li>• Network communication has failed. ➡ Disconnect the dedicated USB cable, wait at least 2 seconds, and then reconnect it. If the recorder is still not recognized, disconnect the dedicated USB cable, restart the computer, and then connect the dedicated USB cable again</li> </ul>
Even though the recorder is recognized by the computer, it does not operate normally.	<ul style="list-style-type: none"> <li>• A USB hub is used. ➡ Connect the dedicated USB cable directly to the USB port of the computer.</li> <li>• You are using the recorder at a place with vibration. ➡ Use the recorder at a place with no vibration.</li> </ul>
The recorder cannot be used as a storage device.	<ul style="list-style-type: none"> <li>• The SonicStage or MD Simple Burner software is active. ➡ Close the SonicStage or MD Simple Burner software.</li> <li>• A standard disc is inserted. ➡ Insert a disc used in Hi-MD mode. Only discs used in Hi-MD mode can be used as a storage media.</li> </ul>
The playing time of a transferred track is different from the time that appears on your computer monitor.	This is due to a calculation discrepancy between the recorder and the computer.

Symptom	Cause/Remedy
You cannot transfer tracks that will fill up the remaining recording time on the disc.	<ul style="list-style-type: none"> <li>The minimum recordable time on a disc is normally 2 seconds in stereo, 4 seconds in LP2 stereo mode, and 8 seconds in LP4 stereo mode. When you transfer a track from your computer, the recorder needs a 2-second (or 4- or 8-second) space for a track even if the track is under 2 seconds (or 4 or 8 seconds) in length. Also, the recorder inserts a 2-second (or 4 or 8-second) space in between tracks during transfer operation. For this reason, the recorder needs an additional 6 seconds (or 12 or 24 seconds) for each track. This reduces the maximum recording time for each track by 6 seconds (or 12 or 24 seconds) during transfer operation (in MD mode only).</li> </ul>
The disc size displayed on the computer is not the same as the disc size printed on the disc.	<ul style="list-style-type: none"> <li>The difference is due to the use of the binary system to indicate the disc size on the computer and the decimal system to express the disc size on the disc and other recording media. For details on the disc size, see page 60.</li> </ul>
You cannot operate the recorder ("PC –MD" appears).	<ul style="list-style-type: none"> <li>You cannot operate the recorder while the recorder is connected to the computer.</li> </ul>
The lid does not open.	<ul style="list-style-type: none"> <li>It happens if you disconnect the dedicated USB cable in the middle of a data transfer, recording, or editing operation on the computer, but while the dry alkaline battery is drained. <ul style="list-style-type: none"> <li>➔ Reconnect the dedicated USB cable or insert a new dry alkaline battery into the recorder, and then press ■.</li> </ul> </li> </ul>

## Others



Symptom	Cause/Remedy
Some menu items cannot be displayed.	<ul style="list-style-type: none"> <li>"Menu Mode" is set to "Simple". <ul style="list-style-type: none"> <li>➔ Set the "Menu Mode" to "Advanced" to display all the menu items.</li> </ul> </li> </ul>
The recorder does not work or works poorly.	<ul style="list-style-type: none"> <li>The volume is low. <ul style="list-style-type: none"> <li>➔ Turn up the volume.</li> </ul> </li> <li>No disc is inserted. <ul style="list-style-type: none"> <li>➔ Insert a recorded disc.</li> </ul> </li> <li>The HOLD function is turned on ("HOLD" appears in the display when you press an operation button on the recorder). <ul style="list-style-type: none"> <li>➔ On the recorder, disable HOLD by sliding the HOLD switch to the opposite direction of the arrow (pages 12, 13).</li> </ul> </li> <li>The lid is not firmly closed. <ul style="list-style-type: none"> <li>➔ Close the lid until it clicks. Then slide OPEN to open the lid.</li> </ul> </li> <li>Moisture has condensed inside the recorder. <ul style="list-style-type: none"> <li>➔ Take the MD out and leave the recorder in a warm place for several hours until the moisture evaporates.</li> </ul> </li> <li>The dry battery is weak ("LOW BATTERY" flashes or nothing appears). <ul style="list-style-type: none"> <li>➔ Replace the dry battery with a new one.</li> </ul> </li> </ul>









Symptom	Cause/Remedy
<p>The recorder does not work or works poorly.</p>	<ul style="list-style-type: none"> <li>• The disc is damaged or does not contain proper recording or editing data.  ➔ Reinsert the disc. Rerecord the disc. If the error message still appears, replace it with another disc.</li> <li>• There is a built-in malfunction in the system.</li> <li>• While operating, the recorder received a mechanical shock, too much static, abnormal power voltage caused by lightning, etc.  ➔ Restart the operation as follows. <ol style="list-style-type: none"> <li>1 Disconnect all the power sources and the dedicated USB cable.</li> <li>2 Leave the recorder for about 30 seconds.</li> <li>3 Connect the power source.</li> </ol> </li> </ul>
<p>The display window is not normal.</p>	<ul style="list-style-type: none"> <li>• The recorder was disconnected from the power source.  ➔ Let the recorder sit for a while, or disconnect the power source, reconnect it, and then press any of the operation buttons.</li> </ul>
<p>The operation mode of the blank 60/74/80-minute standard disc differs from the mode following formatting or the mode selected in the SonicStage software.</p>	<ul style="list-style-type: none"> <li>• When using a blank 60/74/80-minute standard disc in the recorder, the operation mode set in the “Disc Mode” menu is applied.  ➔ Use the “Disc Mode” menu to change the operation mode as desired.</li> </ul>

## Messages

If the following messages flash in the display window, check the chart below.

Message	Meaning/Remedy
AVLS NO VOLUME OPERATION	<ul style="list-style-type: none"> <li>• AVLS is set to “AVLS On” and so the volume cannot rise higher. ➔ Set AVLS to “AVLS Off” (page 52).</li> </ul>
BLANKDISC	<ul style="list-style-type: none"> <li>• A disc with no recording on it is inserted.</li> </ul>
BUSY WAIT A MOMENT	<ul style="list-style-type: none"> <li>• The recorder is accessing disc information.</li> <li>• You tried to operate the recorder while it was accessing the recorded data. ➔ Wait until the message goes out (in rare cases, it may take a few minutes).</li> </ul>
CANNOT EDIT	<ul style="list-style-type: none"> <li>• You selected, “ : Set”, “ : Release”, “Move”, or “Erase” while recording.</li> <li>• You tried to erase the track mark at the beginning of the first track or group.</li> <li>• You tried to erase a track mark to combine tracks the recorder cannot combine (a track recorded in stereo and in mono, for example).</li> <li>• You tried to overwrite a track marks.</li> <li>• You tried to change a title that includes characters the recorder cannot edit. ➔ Editing titles cannot be done if the title includes characters that cannot be input on the recorder.</li> </ul>
CANNOT OPERATE	<ul style="list-style-type: none"> <li>• You tried to press <b>II</b> or T MARK during synchro-recording.</li> </ul>
CANNOT RECORD OR PLAY	<ul style="list-style-type: none"> <li>• There is no audio data that can be played on the recorder.</li> <li>• The audio data or disc management file has been damaged. ➔ Erase the whole disc (page 48) or perform the Format function (page 50).</li> </ul>
CANNOT SET	<ul style="list-style-type: none"> <li>• You tried to make the Time Mark setting during synchro-recording.</li> <li>• You selected “RECVolume” while the recorder is not in recording-pause. ➔ Set “RECVolume” while the recorder is in recording-pause.</li> <li>• You tried to make the following settings while recording.               <ul style="list-style-type: none"> <li>— Disc Memory</li> <li>— Play mode</li> <li>— Recording mode</li> <li>— Recording level</li> <li>— Selection of “ :REC” in menu</li> </ul> </li> </ul>
DATA SAVE	<ul style="list-style-type: none"> <li>• The recorder is writing information to the system file, such as the recorded data or editing information. ➔ Wait until the message disappears from the display.</li> </ul>
DC IN TOO HIGH	<ul style="list-style-type: none"> <li>• Voltage of the power supply is too high (The recommended optional AC power adaptor or car battery cord is not being used). ➔ Use the recommended (optional) AC power adaptor or car battery cord.</li> </ul>

Message	Meaning/Remedy
DISC FULL	<ul style="list-style-type: none"> <li>Recording may not be done if the remaining recordable time on the disc is 48 seconds or less.</li> <li>➔ Replace the disc.</li> </ul>
D-L READY	<ul style="list-style-type: none"> <li>MD Simple Burner is now ready to record an audio CD to the disc in the recorder using Simple mode (see “Software Operation”).</li> </ul>
EJECT DISC OK	<ul style="list-style-type: none"> <li>The recorder has finished communicating with the computer and it is safe to eject the disc from the recorder or disconnect the dedicated USB cable.</li> </ul>
End	<ul style="list-style-type: none"> <li>The recorder reached to the end of the disc while playing or pressing ►►.</li> </ul>
ERROR	<ul style="list-style-type: none"> <li>There is an internal malfunction in the system.</li> <li>➔ Restart the operation by doing steps 1 to 3 on page 73.</li> </ul>
ERROR XX	<ul style="list-style-type: none"> <li>There is an internal malfunction in the system.</li> <li>➔ Restart the operation by doing steps 1 to 3 on page 73. If the message appears again, please consult your nearest Sony dealer.</li> </ul>
FORMAT ERROR DISC	<ul style="list-style-type: none"> <li>A disc with a format that the recorder does not support was inserted.</li> <li>A disc formatted on the computer was inserted.</li> <li>➔ Insert a standard MD or a disc used in Hi-MD mode.</li> <li>➔ When formatting a disc on the computer, make sure to use the SonicStage software.</li> </ul>
GROUP FULL	<ul style="list-style-type: none"> <li>You tried to create a 256th group on a disc used in Hi-MD mode or 100th group on a standard disc.</li> <li>➔ You can create only up to 255 groups (on a disc used in Hi-MD mode) or 99 groups (on a standard disc) on a disc. Keep the group number within 255 or 99.</li> </ul>
HOLD	<ul style="list-style-type: none"> <li>The recorder is locked.</li> <li>➔ Slide HOLD against the arrow to unlock the recorder (page 13).</li> </ul>
LOW BATTERY	<ul style="list-style-type: none"> <li>A battery is weak.</li> <li>➔ Replace the dry battery (page 13).</li> </ul>
MEMORY OVER	<ul style="list-style-type: none"> <li>You tried to record with the recorder placed where it receives continuous vibration.</li> <li>➔ Put the recorder on a stable place, and start recording again.</li> </ul>
NO BOOKMARK TRACK	<ul style="list-style-type: none"> <li>You selected bookmark play without setting bookmarks.</li> <li>➔ Set bookmarks (page 36).</li> </ul>
NO DIGITAL COPY	<ul style="list-style-type: none"> <li>You tried to make a copy from a disc that is protected by the Serial Copy Management System. You cannot make copies from a digitally connected source which was itself recorded using digital connection.</li> <li>➔ Use analog connection instead (page 26).</li> </ul>
NO DISC	<ul style="list-style-type: none"> <li>You tried to play or record with no disc in the recorder.</li> <li>➔ Insert a disc.</li> </ul>
NO DISC MEMORY	<ul style="list-style-type: none"> <li>You tried to erase a setting in the Disc Memory on a disc that contains no settings in the Disc Memory (page 53).</li> </ul>

Message	Meaning/Remedy
NO GROUP	<ul style="list-style-type: none"> <li>You tried to release a group setting with a disc that has no groups. ➔ Insert a disc with group settings.</li> <li>You selected “ : Erase” with a disc without group setting. ➔ You cannot erase groups with a disc with no groups.</li> </ul>
NO INPUT SIGNAL	<ul style="list-style-type: none"> <li>The recorder could not detect digital input signals. ➔ Make sure that the source is connected firmly (page 15).</li> </ul>
NO NAME	<ul style="list-style-type: none"> <li>You tried to select “Artist” in the Main play mode with a disc that has no artist name information.</li> <li>You tried to select “by Artist” in the Search function with a disc that has no artist name information.</li> </ul>
NON GROUPED TRACK	<ul style="list-style-type: none"> <li>You selected “ : Move” or “ : Erase”, or you tried to label a group while the recorder is stopped or while playing a track that does not belong to a group. ➔ Select a track within a group you want to edit, and then do the editing operation again.</li> </ul>
NotENOUGH POWER TO EDIT	<ul style="list-style-type: none"> <li>You tried to edit the contents of a 1GB Hi-MD disc with insufficient battery power for editing (page 65). ➔ Insert a new alkaline dry battery or connect the AC power adaptor (not supplied) to the recorder.</li> </ul>
NotENOUGH POWER TO REC	<ul style="list-style-type: none"> <li>You tried to record on a 1GB Hi-MD disc with insufficient battery power for recording (page 65). ➔ Insert a new alkaline dry battery or connect the AC power adaptor (not supplied) to the recorder.</li> </ul>
NO TITLE	<ul style="list-style-type: none"> <li>You tried to select “Album” in the Main play mode with a disc that has no album name information.</li> <li>You tried to select “by Album” in the Search function with a disc that has no album name information.</li> </ul>
NO TRACK	<ul style="list-style-type: none"> <li>You tried to play a disc with no recorded tracks. ➔ Insert a recorded disc.</li> </ul>
NO TRACK IS SELECTED	<ul style="list-style-type: none"> <li>You selected “ : Move” or “ : Erase”, or you tried to lable a track without first selecting a track. ➔ Do the editing operation again after selecting the desired track first.</li> </ul>
P/B ONLY DISC	<ul style="list-style-type: none"> <li>You tried to record or edit on a premastered disc (P/B stands for “playback”). ➔ Insert a recordable disc.</li> </ul>
PC – –MD	<ul style="list-style-type: none"> <li>The recorder is connected to the computer.</li> </ul>
PROTECTED DISC	<ul style="list-style-type: none"> <li>You tried to record or edit on a disc with the tab in the record-protect position. ➔ Slide the tab back (page 62).</li> </ul>
PUSH STOP BUTTON	<ul style="list-style-type: none"> <li>You tried to open the lid by sliding the OPEN switch while the recorder was storing disc information with the dedicated USB cable connecting the recorder to a computer. ➔ Operation must be done only after pressing  and “SYSTEM FILE WRITING” has disappeared from the display.</li> </ul>

<b>Message</b>	<b>Meaning/Remedy</b>
READ ERROR	<ul style="list-style-type: none"> <li>The recorder cannot read the disc information correctly. ➔ Reinsert the disc.</li> </ul>
REC ERROR	<ul style="list-style-type: none"> <li>Recording was not correctly done. ➔ Place the recorder at a place with no vibrations and record again.</li> <li>The disc is soiled with an oil film or finger prints, is scratched, or is not a standard disc. ➔ Try recording again with another disc.</li> </ul>
SYSTEM FILE WRITING	<ul style="list-style-type: none"> <li>The recorder is storing information (track start and end position) from the memory to the disk. ➔ Wait until this process is completed. Do not expose the player to physical shock, nor disrupt power supply.</li> </ul>
TEMP OVER REC STOP	<ul style="list-style-type: none"> <li>Heat has built up in the recorder. ➔ Let the recorder cool down.</li> </ul>
TITLE FULL	<ul style="list-style-type: none"> <li>You tried to enter more than 200 letters to label a single track, group, or disc.</li> <li>You tried to enter a total of more than approximately 55,000 letters (in Hi-MD mode) or 1,700 letters (in MD mode) for titles.</li> </ul>
TOC DATA ERROR	<ul style="list-style-type: none"> <li>The recorder cannot read the disc information correctly. ➔ Insert another disc. ➔ If it is no problem to erase the entire disc, do so (page 48).</li> </ul>
TRACK FULL	<ul style="list-style-type: none"> <li>You tried to record more than 2,047 tracks on a disc in Hi-MD mode or more than 254 tracks on a disc in MD mode. ➔ Erase unnecessary tracks (page 47).</li> </ul>
TrkFromPC NO EDIT	<ul style="list-style-type: none"> <li>You tried to combine or divide tracks that were transferred from the computer. ➔ You cannot combine or divide transferred tracks.</li> <li>You tried to combine or divide tracks that were recorded in Hi-MD mode using the MD Simple Burner software. ➔ You cannot combine or divide tracks recorded in Hi-MD mode with the MD Simple Burner software.</li> </ul>
TrkFromPC NO REC	<ul style="list-style-type: none"> <li>You tried to record in the middle of a protected track that has been transferred from the computer.</li> <li>You tried to record in the middle of a track that was recorded in Hi-MD mode with the MD Simple Burner software. ➔ You cannot record new material in the middle of a protected track or a track that was recorded in Hi-MD mode with the MD Simple Burner software.</li> </ul>

---

## Explanations

### About Hi-MD

“Hi-MD” is a new MiniDisc format.

Incorporating the new ATRAC3plus audio compression technology, Hi-MD is a new recording format that delivers longer recording times than ordinary MDs. Hi-MD discs can also be used as a computer storage medium for non-audio data such as text and images.

For more details on Hi-MD, refer to the supplied flyer “What you can do with the Hi-MD Walkman”.

### About ATRAC3plus

ATRAC3plus is an enhanced version of ATRAC3.

Compared to ATRAC3 (used in LP2 and LP4 mode of the recorder), which attains a compression ratio 10 times higher than that of a CD, ATRAC3plus (used in Hi-SP and Hi-LP mode of the recorder) achieves a higher compression ratio that is 20 times higher than that of a CD, but with no loss in sound quality.

### “Hi-MD mode” and “MD mode”

This recorder has two operation modes, “Hi-MD mode” and “MD mode” that are automatically recognized whenever a disc is inserted. If you insert a blank disc, the recorder allows you to specify either of these operation modes for disc recording (except in the case of Hi-MD discs that support Hi-MD mode only). When using a blank disc, set the “Disc Mode” setting to select either “Hi-MD” or “MD”.

### About Linear PCM

Linear PCM is a digital, non-compressed audio coding system. You can enjoy high-quality sound equal to that of CDs by recording in this mode.

### The meaning of “no sound”

“No sound” describes a recorder condition in which the input level is about 4.8 mV during analog input or less than -89 dB during optical (digital) input (with 0 dB as full bit (the maximum recordable level for a MiniDisc)).

### About “System File”

The system file is space on the disc that is used to store information other than audio files; for instance, track numbers.

If the MiniDisc were a book, the system file would correspond with the index or table of contents. The recorder rewrites the system file whenever an operation such as recording, adding or deleting track marks, or moving tracks has been done. (“SYSTEM FILE WRITING” appears in the display when the recorder is rewriting the system file.) While the recorder is writing disc information, make sure not to move or jog the recorder or disconnect the power source as this may cause the information to be incorrectly recorded or the disc contents to be lost.

## List of the recording time for each disc

### When using a disc in Hi-MD mode

When recording on the recorder		Recording time <sup>1)</sup>			
Recording mode on the recorder	Codec/Bit rate	1GB Hi-MD disc	80-minute standard disc	74-minute standard disc	60-minute standard disc
PCM	Linear PCM/1.4Mbps	1 hour and 34 minutes	28 minutes	26 minutes	21 minutes
Hi-SP	ATRAC3plus/256kbps	7 hours and 55 minutes	2 hours and 20 minutes	2 hours and 10 minutes	1 hour and 45 minutes
Hi-LP	ATRAC3plus/64kbps	34 hours	10 hours and 10 minutes	9 hours and 25 minutes	7 hours and 40 minutes
When transferring from the computer		Recording time <sup>1)2)</sup>			
Codec/Bit rate		1GB Hi-MD disc	80-minute standard disc	74-minute standard disc	60-minute standard disc
Linear PCM/1.4Mbps		1 hour and 34 minutes	28 minutes	26 minutes	21 minutes
ATRAC3plus/256kbps		7 hours and 55 minutes	2 hours and 20 minutes	2 hours and 10 minutes	1 hour and 45 minutes
ATRAC3plus/64kbps		34 hours	10 hours and 10 minutes	9 hours and 25 minutes	7 hours and 40 minutes
ATRAC3plus/ 48 kbps		45 hours	13 hours and 30 minutes	12 hours and 30 minutes	10 hours and 10 minutes
ATRAC3/132kbps		16 hours and 30 minutes	4 hours and 50 minutes	4 hours and 30 minutes	3 hours and 40 minutes
ATRAC3/105kbps		20 hours and 50 minutes	6 hours and 10 minutes	5 hours and 40 minutes	4 hours and 40 minutes
ATRAC3/66kbps		32 hours and 50 minutes	9 hours and 50 minutes	9 hours	7 hours and 20 minutes

<sup>1)</sup> Approximate time

<sup>2)</sup> When transferring 5-minute tracks

## When using a disc in MD mode

When recording on the recorder		Recording time <sup>1)</sup>		
Recording mode on the recorder	Codec/Bit rate	80-minute standard disc	74-minute standard disc	60-minute standard disc
SP	ATRAC3/ 292kbps	80 minutes	74 minutes	60 minutes
LP2	ATRAC3/ 132kbps	2 hours and 40 minutes	2 hours and 28 minutes	2 hours
LP4	ATRAC3/66kbps	5 hours and 20 minutes	4 hours and 56 minutes	4 hours
MONO (monaural)	Monaural	2 hours and 40 minutes	2 hours and 28 minutes	2 hours
When transferring from the computer		Recording time <sup>1)2)</sup>		
Codec/Bit rate		80-minute standard disc	74-minute standard disc	60-minute standard disc
ATRAC(stereo)/292kbps		80 minutes	74 minutes	60 minutes
ATRAC3/132, 105kbps		2 hours and 40 minutes	2 hours and 28 minutes	2 hours
ATRAC3/66kbps		5 hours and 20 minutes	4 hours and 56 minutes	4 hours

<sup>1)</sup> Approximate time

<sup>2)</sup> When transferring 5-minute tracks



## Note on digital recording

This recorder uses the Serial Copy Management System, which allows only first-generation digital copies to be made from premastered software. You can only make copies from a home-recorded disc by using the analog (line out) connections.

Premastered software such as CDs or MDs.

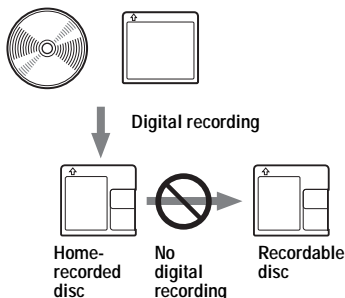

Microphone, record player, tuner, etc. (with analog output jacks).

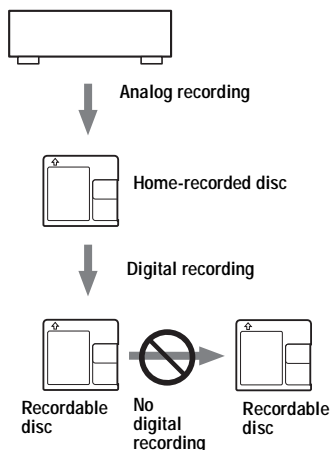

## Restrictions on the editing of tracks transferred from your computer

This unit was designed so that editing functions (i.e., adding track marks and erasing track marks) do not function for tracks that have been transferred from your computer. This is to prevent the loss of transfer authorization by the transferred tracks. To edit these tracks, first transfer them into the computer, and then edit them on the computer.

## About the DSP TYPE-S for ATRAC/ATRAC3

This recorder supports DSP TYPE-S, a specification for high-level Sony MiniDisc decks equipped with digital signal processors (DSP). This specification allows the recorder to produce high-quality sound from tracks recorded in MDLP mode. Since it retains DSP TYPE-R support, the recorder produces superior results during recording or playback in SP (normal stereo) mode.

## Suppressing the skips of the sound (G-PROTECTION)

The G-PROTECTION function was developed to provide a higher level of shock resistance than that of existing players.

## Difference between digital (optical) and analog (line) inputs

The input jack of this recorder works as both digital and analog input jacks. Connect the recorder to a CD player or a cassette recorder using either digital (optical) input or analog (line) input. To record, see “Recording a disc right away!” (page 15) to record using digital (optical) input, and “Recording from a TV or radio (Analog Recording)” (page 26) to record using analog (line) input.

Difference	Digital (optical) input	Analog (line) input
Connectable source	Equipment with a digital (optical) output jack (CD player, DVD player, etc.)	Equipment with an analog (line) output jack (Cassette deck, radio, record player, etc.)
Usable cord	Optical cable (with an optical or an optical-mini plug) (page 15)	Line cable (with 2 phono plugs or a stereo-mini plug) (page 26)
Signal from the source	Digital	Analog Even when a digital source (such as a CD) is connected, the signal sent to the recorder is analog.
Track marks <sup>1)</sup>	Marked (copied) automatically <ul style="list-style-type: none"><li>• at the same positions as the source (when the sound source is a CD or an MD).</li><li>• after more than 2 seconds of no sound (page 78) or low-level segment (with a sound source other than a CD or an MD).</li><li>• when the recorder is paused (3 seconds of no sound is encountered while synchro-recording)</li></ul>	Marked automatically <ul style="list-style-type: none"><li>• after more than 2 seconds of no sound (page 78) or low-level segment.</li><li>• when the recorder is paused while recording.</li></ul>
Recorded sound level	Same as the source. Can also be adjusted manually (Digital REC level control) (“Adjusting the recording level manually”, page 28).	Adjusted automatically. Can also be adjusted manually (“Adjusting the recording level manually”, page 28).

<sup>1)</sup> You can erase unnecessary marks after recording. (“Combining tracks (Combine)”, page 49).

### Note

Track marks may be copied incorrectly:

- when you record from some CD players or multi disc players using digital (optical) input.
- when the source is in shuffle or program play mode while recording using digital (optical) input. In this case, play the source in normal play mode.
- when programs with audio that is digitally broadcast (e.g., digital TV) are recorded through the digital (optical) input.



# What you can do with MD Simple Burner/SonicStage

## What you can do with MD Simple Burner

MD Simple Burner allows you to record music tracks from an audio CD in the CD drive of your computer to an MD Walkman, without first recording the music tracks to the computer.



## What you can do with SonicStage

SonicStage allows you to import audio data to your computer from music sources such as audio CDs and the Internet, and then transfer the audio data stored in your computer to an MD.

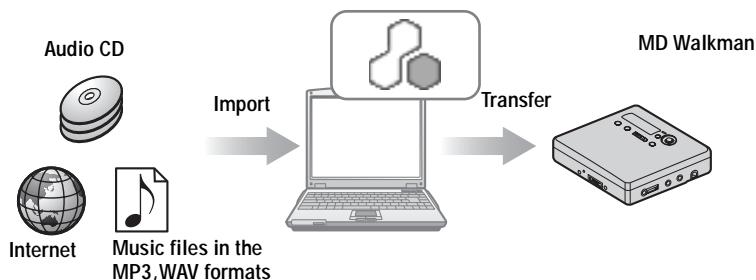

## Basic operational flow using an MD Walkman

● MD Simple Burner

● SonicStage

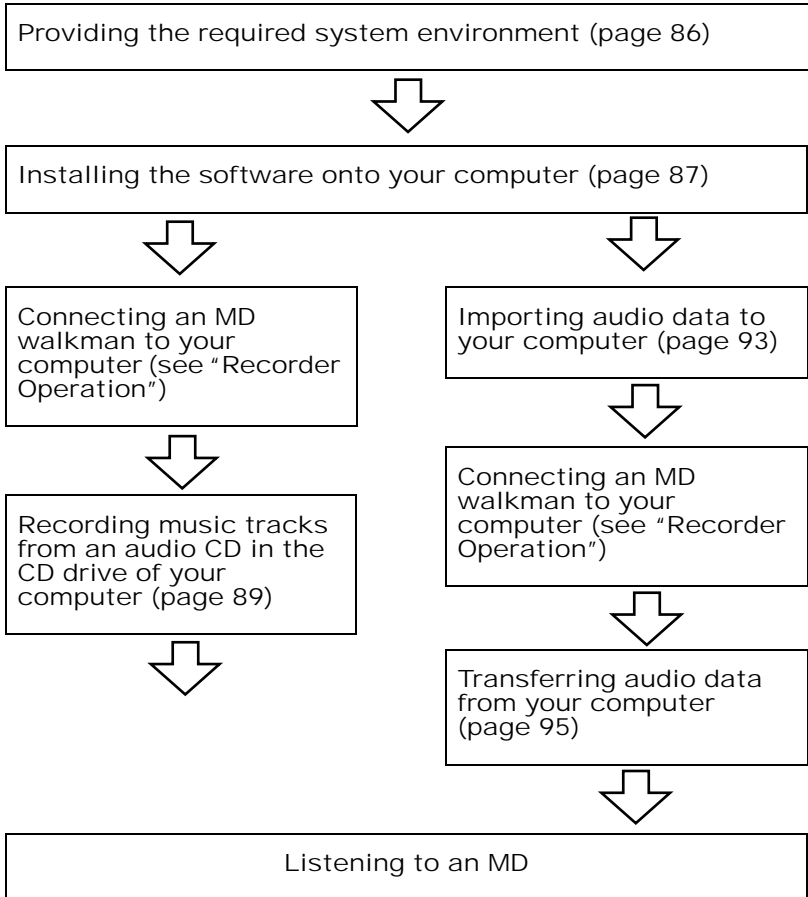

## Providing the required system environment

### System requirements

The following system environment is required in order to use the SonicStage/MD Simple Burner software for the MD Walkman.

Computer	IBM PC/AT or Compatible
	<ul style="list-style-type: none"><li>• CPU: Pentium II 400 MHz or higher (Pentium III 450 MHz or higher is recommended.)</li><li>• Hard disk drive space: 200 MB or more (1.5 GB or more is recommended) (The amount space will vary according to Windows version and the number of music files stored on the hard disk.)</li><li>• RAM: 64 MB or more (128 MB or more is recommended)</li></ul>
	Others <ul style="list-style-type: none"><li>• CD drive (capable of digital playback by WDM)</li><li>• Sound Board</li><li>• USB port (supports USB (previously USB 1.1))</li></ul>
Operating System	Factory installed: Windows XP Media Center Edition 2004/Windows XP Media Center Edition/Windows XP Professional/Windows XP Home Edition/ Windows 2000 Professional/Windows Millennium Edition/Windows 98 Second Edition
Display	High Color (16bit) or higher, 800 × 600 dots or better (1024× 768 dots or better is recommended)
Others	<ul style="list-style-type: none"><li>• Internet access: for Web registration, EMD services and CDDB</li><li>• Windows Media Player (version 7.0 or higher) installed for playing WMA files</li></ul>

This software is not supported by the following environments:

- OSs other than the indicated above
- Personally constructed PCs or operating systems
- An environment that is an upgrade of the original manufacturer-installed operating system
- Multi-boot environment
- Multi-monitor environment
- Macintosh

#### Notes

- We do not ensure trouble-free operation on all computers that satisfy the system requirements.
- The NTFS format of Windows XP/Windows 2000 Professional can be used only with the standard (factory) settings.
- We do not ensure trouble-free operation of the system suspend, sleep, or hibernation function on all computers.
- For Windows 2000 Professional users, install Service Pack 3 or later version before using the software.

---

# Installing the software onto your computer

## Before installing the software

- Make sure to close any virus-check software, as such software usually demands a large amount of system resources.
- When you use the MD Walkman, make sure to install the software with the supplied CD-ROM.
  - If OpenMG Jukebox, SonicStage or Net MD Simple Burner is installed already, the previous software will be overwritten by the new version. The new version retains the functions of the older version, but with new functions added.
  - If SonicStage Premium or SonicStage Simple Burner is installed already, the previous software will co-exist with the new version.
  - You will still be able to use music data registered by an older software version even after SonicStage has been installed. As a precaution, we recommend that you back up your music data. To back up the data, refer to [Backing Up My Library] – [Backing Up Data to a Disk] on SonicStage Help.
- If the MD Walkman is connected to the computer with the USB cable, make sure to disconnect the USB cable first before installing the software.

---

1 Turn on your computer and start up Windows.

---

2 Insert the supplied CD-ROM into the CD drive of your computer.

The setup program starts up automatically and the installation window appears. Depending on the region, a window may appear asking you to select your country. In this case, follow the displayed instructions.

- 
- 3 Click [Install SonicStage and MD Simple Burner] and then follow the displayed instructions.

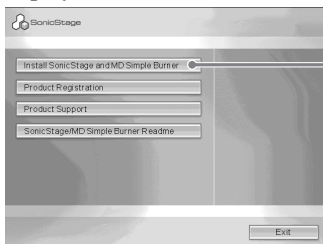

Click [Install SonicStage and MD Simple Burner]

Read the instructions carefully.

Depending on your region, the buttons other than [Install SonicStage and MD Simple Burner] may differ from those in the illustration above.

The installation may take 20 to 30 minutes, depending on your system environment.

Make sure to restart your computer only after the installation is completed.

---

Was the installation successful?

If any trouble occurs during the installation, see “Troubleshooting” (page 106).



## Before using MD Simple Burner

MD Simple Burner allows you to record music tracks from an audio CD in the CD drive of your computer to the MD Walkman.

There are two ways to record from an audio CD.

- **Simple mode (page 90)**

You can use MD Walkman operations to record an entire CD or only the first track without launching MD Simple Burner.

- **Standard mode (page 91)**

You can launch MD Simple Burner to record using computer operations. Record an entire CD or selected tracks.

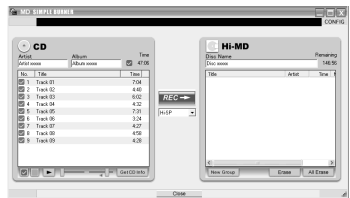

### Notes

- Only audio CDs with a  mark can be used with MD Simple Burner.
- We do not guarantee normal operation in the case of the copy-controlled CDs.
- You cannot record in simple mode while the MD Simple Burner in standard mode or OpenMG software (SonicStage, OpenMG Jukebox, etc.) is active.

---

## Recording using MD Walkman operations (Simple mode)

---

- 1 Insert a recordable disc into the MD Walkman and then connect the MD Walkman to the computer.

For details about connections, see the “Recorder Operation” section.

Do not disconnect the power source or the dedicated USB cable before the transfer has completed.

---

- 2 Insert the audio CD that you want to record into the CD drive of your computer.

The CDDB registration window appears when you use the CDDB for the first time.

You need to connect the computer to the Internet in order to use the CDDB.

---

- 3 Press and hold T MARK/REC and press ►ENT on the MD Walkman.

The recording starts.

All tracks on the CD are recorded as a new group.

---

### To stop recording

Click ►Abort on the computer display.

While the first track is being recorded, you can use ■ (stop) button to stop on the MD Walkman.

### Setting the recording mode

Before starting recording, right-click the  MD Simple Burner icon in the task tray, and then select in [recording mode].

### Recording first track only

Before starting recording, right-click the  MD Simple Burner icon in the task tray, and then select [Recording settings] – [Record 1st Track Only].

### Setting when the CDDB has more than one item of information

Right-click the  MD Simple Burner icon in the task tray, and then select the setting by clicking [CDDB(r)] – [Multiple Matches].

- [User Selection]: A selection window is displayed
- [No Resolve]: No CD information is downloaded
- [First Choice]: The first item is downloaded



## Recording by computer operations (Standard mode)

To start MD Simple Burner, click [Start] – [All Programs]\* – [MD Simple Burner] – [MD Simple Burner].

\* [Programs] in the case of Windows 2000 Professional/Windows Millennium Edition/Windows 98 Second Edition



There are other ways to start up MD Simple Burner as follows:

- Double-click the  MD Simple Burner icon in the task tray, or right-click and select [Show Standard Mode].
- Double-click the  MD Simple Burner shortcut icon on the desktop.

### The window for recording all tracks on the CD

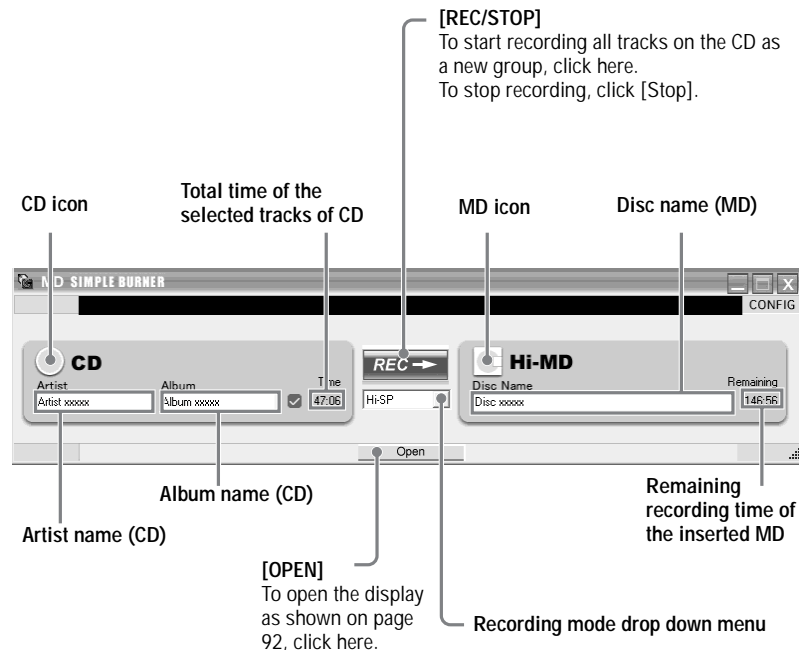

## The window for recording selected tracks from an audio CD

Track information (CD)

[CONFIG]

Click here to do the following:

- Set the CD-ROM drive
- View version information for MD Simple Burner
- Confirm CD information registered in the CDDB

Artist name

Total time of the selected tracks of CD

Track information (MD)

You can change the track name and track number

Album Title

[REC/STOP]

Disc name (MD)

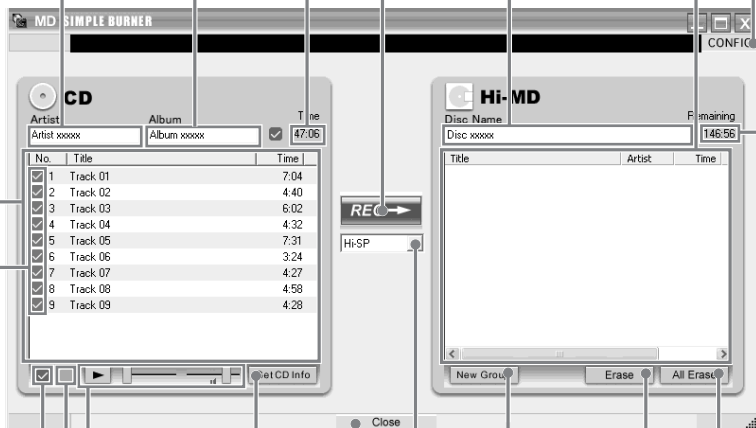

[Get CD info]

Information of an audio CD (album name, track title, etc.) will be reflected in the track list.

[New Group]

Recording mode drop down menu

[CLOSE]

To close the display as shown on page 91, click here.

CD operating section

Use these controls to confirm the tracks on audio CD to be recorded

To deselect all tracks, click here.

To select all tracks, click here.

[Erase]

[All Erase]

Check boxes

Check the box of the tracks that you want to record

Remaining time of the inserted MD

## Importing audio data

This section explains how to record and store audio data from an audio CD to My Library of SonicStage on the hard disk drive of your computer.

You can record or import music from other sources such as the Internet and your computer's hard disk. Refer to SonicStage Help for details.

### Notes

- Only audio CDs with a  mark can be used with SonicStage.
- We do not guarantee normal operation in the case of the copy-controlled CDs.

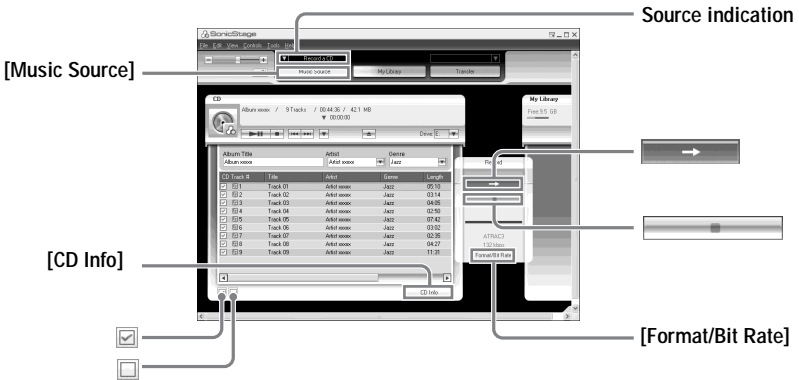

### 1 Start up SonicStage.

Select [Start] – [All Programs]\* – [SonicStage] – [SonicStage].

\*[Programs] in the case of Windows 2000 Professional/Windows Millennium Edition/Windows 98 Second Edition

SonicStage starts up and the main window appears.



You can also start SonicStage with double click  ([SonicStage] icon) on the desktop.

### 2 Insert the audio CD that you want to record into the CD drive of your computer.

The source indication in the top-left of the display changes to [Record a CD].

### 3 Click [Music Source].

The contents of the audio CD appear in the music source list (on the left side of the screen).

continued

---

4 If necessary, click  to uncheck tracks you do not want to record.

If you unchecked a box by mistake, click it again to restore the check.

To check all boxes, click .

To uncheck all boxes, click .

---

5 If necessary, change the format and bit rate for audio CD recording.

When you click [Format/Bit Rate] on the right side of the screen, “CD Recording Format [My library]” dialog box will appear. The dialog box will ask you to select the format and bit rate for recording the audio CD.

---

6 Click .

The recording of the tracks selected in step 4 starts.

---

To stop recording

Click .



If CD information such as album title, artist name, and track names could not be obtained automatically, click [CD Info] on the right side of the screen. When you do this, your computer must be connected to the Internet.

---

## Transferring audio data from your computer to the MD Walkman

Audio data stored in My Library of SonicStage can be transferred to your MD Walkman an infinite number of times.

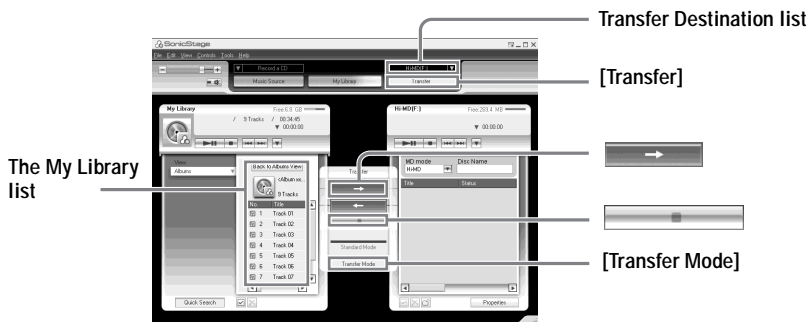

- 
- 1 Connect your MD Walkman to the computer.  
For details about connections, see “Recorder Operation”.  
Do not disconnect the power source or the dedicated USB cable before the transfer has completed.
  - 2 Select the transfer destination from the Transfer Destination list on the right side of the screen and click [Transfer].  
The screen is switched to the Transfer (Hi-MD or Net MD) screen.
  - 3 Click the tracks you want to transfer in the My Library list on the left side of the screen.  
To transfer more than one track, hold down the [Ctrl] key while selecting the tracks.  
To transfer all tracks of the album, click the album.
-

---

#### 4 If necessary, change the transfer mode.

As the default setting, tracks in the OpenMG (PCM/ATRAC3/ATRAC3plus) format will be transferred in the same format and bit rate (normal transfer).

If the device connected to the computer does not support the above format, the format and bit rate will be converted to those of the device. In some case, this process may take time.

If you want to change the format and bit rate, click [Transfer Mode] in the center of the screen to display “Transfer Mode Settings” dialog box.

---

#### 5 Click .

Transfer of the tracks selected in step 3 begins.

---

To stop transferring

Click .

When transferring to a Hi-MD Walkman

If you want to play the transferred tracks on a Net MD Walkman that does not support Hi-MD, select [Net MD] for the mode (operation mode) on the right side of the screen after step 2. This operation mode can be selected only when using a standard disc in Hi-MD mode for recording.

#### Notes

- A transfer will fail and an error message will appear in the following cases:
  - When there is no enough free space on the disc.
  - When the track is subject to playback restrictions.
- During the transfer, the system suspend, sleep, or hibernation function will not operate.
- Depending on the type of the text and number of characters, the text entered by SonicStage may not be displayed on the connected MD Walkman. This is due to the limitations of the connected MD Walkman.



## Transferring back audio data from the MD Walkman to your computer



### Transferring from the MD Walkman back to your computer

Audio data that has been transferred from your computer and stored on the MD can be transferred back to My Library of SonicStage on your computer.

- 1** Connect your MD Walkman to the computer.  
For details about connections, see “Recorder Operation”.  
Do not disconnect the power source or the dedicated USB cable before the transfer has completed.
- 2** Select the transfer destination from the Transfer Destination list on the right side of the screen and click [Transfer].  
The screen is switched to the Transfer (Hi-MD or Net MD) screen.
- 3** In the list on the right side of the screen, click to select the tracks you want to transfer to your computer.
- 4** Click  in the middle of the screen.  
The transferring of the tracks selected in step 3 starts.

To stop transferring

Click  .

#### Note

Tracks transferred to the MD Walkman from another computer cannot be transferred back to My Library on your computer.

## Importing tracks recorded on a Hi-MD Walkman\* to your computer

Tracks that have been recorded on a Hi-MD Walkman\* can be imported to My Library of SonicStage on your computer only once.

\* Only tracks recorded in Hi-MD mode

- 1 Insert recordable disc into the Hi-MD Walkman and connect the device to your computer.
- 2 Select the transfer destination from the Transfer Destination list on the right side of the screen and click [Transfer].
- 3 Click the tracks you want to transfer in the Hi-MD list on the right side of the screen.  
To transfer more than one track, hold down the [Ctrl] key while selecting the tracks.  
To transfer all tracks of the group, click the group.
- 4 Click  in the middle of the screen.  
The “Import” dialog box appears.
- 5 Specify the transfer destination in the dialog box.  
To import tracks to a new album, select “Import to a new album” and enter the desired album name in the text box.  
To add the tracks to an existing album in My Library, select “Import to an existing album” and click “Browse” to select the album.
- 6 Click “OK”.  
The importing of the tracks selected in step 3 starts.

## To stop importing

Click  .

### Notes

- You cannot import tracks that were recorded in a Net MD mode to your computer, or tracks that have been recorded on a device that does not support Hi-MD mode.
- Before importing tracks recorded on the Hi-MD Walkman to the computer, click [Properties] on the right side of the screen to confirm the status of the [Import Settings] check box (it is checked by default). Then do as follows:
  - To import tracks to My Library while deleting them on the Hi-MD Walkman, uncheck the box.
  - To edit imported tracks in SonicStage, uncheck the box.
  - To import tracks to My Library while leaving the copy of them on the Hi-MD Walkman, check the box. Tracks left on the Hi-MD Walkman are treated the same as tracks that have been automatically transferred from the computer. For this reason, they cannot be divided or combined on the Hi-MD Walkman.
- When you transfer tracks recorded in linear PCM on the Hi-MD Walkman to a computer for editing (dividing or combining) in My Library, the editing may take a long time, depending on the length of the tracks and capabilities of your computer. This is due to limitations in the MiniDisc system. If you want to edit long tracks recorded in linear PCM, we recommend that you do the editing on the Hi-MD Walkman first, and then transfer the edited data to a computer afterwards.

## Using SonicStage Help

SonicStage Help provides further details on how to use SonicStage. SonicStage Help allows you to search easily for information from a list of operations, such as “Importing Tracks” or “Transferring Tracks”, or from large list of keywords, or by typing in words that might lead you to the appropriate explanations.

### To display SonicStage Help

Click [Help] – [SonicStage Help] while SonicStage is running.

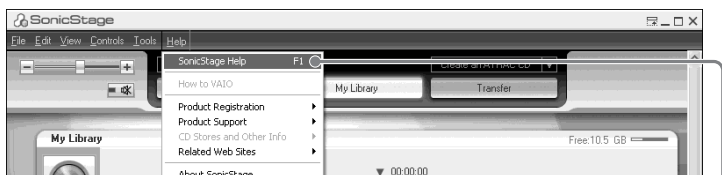

[SonicStage Help]



You can display SonicStage Help by selecting the following:  
[Start] – [All Programs]\* – [SonicStage] – [SonicStage Help].

\* [Programs] in the case of Windows 2000 Professional/Windows Millennium Edition/Windows 98 Second Edition

### Notes

- In SonicStage Help, “Device/Media” is the general term for the external device such as the MD Walkman, the Network Walkman, and the CD Walkman.
- Follow the instructions of your internet provider regarding such things as recommended system environment when using EMD service.

## Understanding SonicStage Help

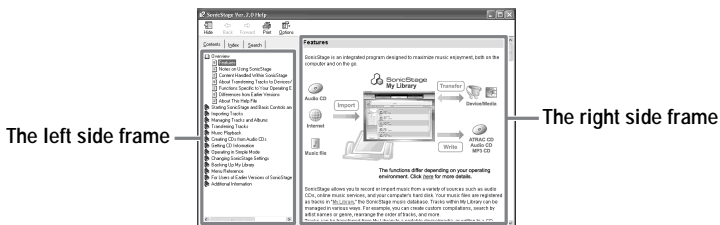

- 1 Double click [Overview] in the left-side frame.
- 2 Click [About This Help File].  
The explanation will appear in the right-side frame.
- 3 Read the text.  
Scroll the display if necessary.  
Click underlined words to jump to their explanations.

## Searching for a word inside an explanation

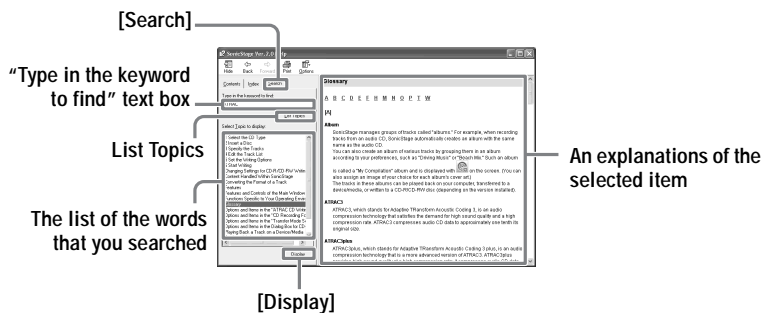

- 1 Click [Search] to open the "Search" window.
- 2 Type in the words.
- 3 Click [List Topics].  
A list of the words that were searched is displayed.
- 4 Click to select the desired item among those displayed.
- 5 Click [Display].  
An explanation of the selected item is displayed.

---

## Referring to SonicStage Help

Click [Contents] on the left side of the Help window to view a list of items for each operation. Click on any items for details.

### Importing audio data to the computer

To	SonicStage Help
Import audio data from the Internet	[Importing Tracks] – [Purchasing Tracks from a Music Service Site]
Import audio files on the computer in SonicStage	[Importing Tracks] – [Importing Music Files]

### Listening to audio data on the computer

To	SonicStage Help
Listen to audio data from the CD drive or My Library	[Music Playback] – [Playing Back an Audio CD] or [Playing Back a Track in My Library]
Listen to audio data on the MD Walkman connected to the computer	[Music Playback] – [Playing Back a Track on a Device/Media]

### Managing and editing imported tracks

To	SonicStage Help
Change information related to CD information downloading	[Changing SonicStage Settings] – [Changing Settings for Getting CD information]
Edit an album Delete the tracks	[Managing Tracks and Albums] – [Creating/Editing Albums]
Change the destination directly for track storage	[Changing SonicStage Settings] – [Changing the Location for Saving Recorded Files]

## Backing up audio data

We recommend that you back up your music data as a precaution against hard disk crashes or computer replacement.

To	SonicStage Help
Back up audio data in My Library	[Backing Up My Library] – [Backing Up Data to a Disk]
Look up about SonicStage backup	[Backing Up My Library] – [FAQ-About SonicStage Backup Tool]

## Troubleshooting

To	SonicStage Help
Look up troubleshooting procedure	[Additional Information] – [Troubleshooting]

## When you want to know

To	SonicStage Help
Look up unknown words	[Additional Information] – [Glossary]
Look up the kinds of audio data that can be managed by SonicStage	[Overview] – [Content Handled Within SonicStage]
Look up the kinds of functions that can be used with SonicStage	[Overview] – [Features]

---

### Uninstalling SonicStage/MD Simple Burner

To uninstall SonicStage/MD Simple Burner, follow the procedures below.

---

1 Click [Start]–[Control Panel]\*.

\* [Settings]–[Control Panel] in the case of Windows 2000 Professional/Windows Millennium Edition/Windows 98 Second Edition

---

2 Double-click [Add/Remove Programs].

---

3 Click [SonicStage 2.x.xx] or [MD Simple Burner 2.0.xx] in the “Currently Installed Programs” list, and then click [Change and Remove]\*.

Follow the displayed instruction and restart your computer. The uninstallation is completed when the computer has restarted.

\* [Change/Remove] in the case of Windows 2000 Professional, [Add/Remove] in the case of Windows Millennium Edition/Windows 98 Second Edition

---

#### **Note**

When you install SonicStage Ver. 2.x/MD Simple Burner Ver. 2.0, OpenMG Secure Module x.x is installed at the same time. Do not delete OpenMG Secure Module x.x since it may be used by other software.



---

## On copyright protection

The OpenMG technology allows you to enjoy digital music, while maintaining the copyrights of its holders. SonicStage encrypts audio files in OpenMG format and stores them on the hard disk of your computer to prevent unauthorized distribution.

### Restrictions on audio content

High-quality digital audio content is widely available through music distribution services on the Internet. To protect the copyrights of its holders from unauthorized distribution, some audio content is distributed with certain restrictions on recording and playback. For example, the playback period or playback count for the data may be limited.

---

## Troubleshooting

Please refer to the following steps if you encounter a problem while using SonicStage/MD Simple Burner.

- 1 Check the symptoms in this “Troubleshooting” section.
- 2 Check the symptoms in SonicStage Help when you use SonicStage.
- 3 If the problem cannot be solved after checking the above references.  
Check the following table and then consult your nearest Sony dealer.

Computer <ul style="list-style-type: none"><li>• Manufacturer:</li><li>• Model:</li><li>• Type: Desktop type / Laptop type</li></ul>
Name of operating system:
RAM capacity:
Hard disk drive (containing SonicStage/MD Simple Burner and audio data) <ul style="list-style-type: none"><li>• Capacity of the drive:</li><li>• Free space:</li></ul>
Version of the software <ul style="list-style-type: none"><li>• SonicStage Ver. 2.x<sup>1)</sup></li><li>• MD Simple Burner Ver. 2.0<sup>2)</sup></li></ul>
Error Message (if one appear):
If an externally connected CD-ROM drive is used <ul style="list-style-type: none"><li>• Manufacturer:</li><li>• Model:</li><li>• Type: CD-ROM / CD-R/RW / DVD-ROM / Other (            )</li><li>• Type of connection to the computer: PC card / USB / IEEE1394 / Other (            )</li></ul>
If another device with USB connection is used <ul style="list-style-type: none"><li>• Name of the device (or devices):</li></ul>

- <sup>1)</sup> To check the SonicStage software version, go to [Help] – [About SonicStage] in the SonicStage window.
- <sup>2)</sup> To check the MD Simple Burner software version, go to [CONFIG] – [Version] in the MD Simple Burner window.

## The software cannot be installed onto your computer

Problem	Cause/Remedy
The installation was not successful.	You are using an OS that does not support this software. → See page 86 for more details. All windows applications are not closed. → If you start the installation while other programs are running, a malfunction may occur. This is especially true for programs that require large amounts of system resources, such as virus-check software. There is not enough hard disk space on your hard disk. → You need 200MB or more free space on your hard disk.
The installation appears to have stopped before it has completed.	Check for the appearance of an error message beneath the installation window. → Press the [Tab] key while holding down the [Alt] key. If an error message has appeared, press the [Enter] key. The installation will resume. If there is no message, the installation is still in progress. Wait a little while longer.
The progress bar on the display is not moving. The access lamp has not lit for a few minutes.	The installation is progressing normally. Please wait. The installation may take 30 minutes or more, depending on your CD drive or system environment.

## Using a MD Walkman connected to the computer

Problem	Cause/Remedy
<p>Your computer does not recognize the MD Walkman.</p>	<p>The MD Walkman is not firmly connected with the supplied dedicated USB cable to the computer.            →Reconnect the MD Walkman to the computer firmly.            →Remove and reconnect the MD Walkman. If the computer still does not recognize the MD Walkman, disconnect the cable, restart the computer, and then make the connection again.</p> <p>A disc is not inserted in the MD Walkman.            →Check if a disc is inserted in the MD Walkman.</p> <p>The Net MD driver is not be installed.            →Install the SonicStage/MD Simple Burner software using the supplied CD-ROM.</p> <p>The software installation failed.            →Disconnect the connected device and install the software again using the supplied CD-ROM.</p> <p>The supplied dedicated USB cable is disconnected.            →Connect the supplied dedicated USB cable firmly.</p> <p>The connections are made through a USB hub.            →Operations are not guaranteed for USB-hub connections. Connect the MD Walkman directly to the USB connector on the computer.</p>
<p>Even though the dedicated USB cable is used to connect the MD Walkman to the computer, the display on the MD Walkman does not indicate it is connected.</p>	<p>It takes time to recognize SonicStage. Please wait.            The other application software is running.            →Reconnect the supplied dedicated USB cable after a while. If the computer still does not recognize the MD Walkman, disconnect the MD Walkman, restart the computer, and connect the dedicated USB cable again.</p>
<p>Even though your computer recognize the MD Walkman, it does not operate normally.</p>	<p>The supplied dedicated USB cable is disconnected.            →Connect the supplied dedicated USB cable firmly.</p> <p>The connections are made through a USB hub.            →Operations are not guaranteed for USB-hub connections. Connect the MD Walkman directly to the USB connector on the computer.</p>

---

# Index

## Numerics

6-Band Equalizer 38

## A

Accessories

optional 64  
supplied 10

ATRAC3plus 78

AVLS 52

## B

Battery

battery life 14

BEEP 53

Bookmark

add 36  
play 36

## C

CD drive 86

CDDB 86, 90

CD-ROM 87

Checking

playing position 33  
remaining time 25, 33

Cleaning 61

Combining tracks 49

Connecting 89, 90

analog 26  
computer 57  
digital 15

Contrast 55

Copyright protection 105

## D

Data storage 59

Disc memory 53

Disc Mode 55

Divide 49

DSP TYPE-S 81

## E

EMD service 86

Erasing

a whole disc 48  
groups 47  
tracks 47

## F

Format 50

## G

G-PROTECTION 81

Group

erasing 47  
moving 46  
recording 30  
releasing 44  
setting 43

## H

Hard disk

free space 86

Hi-MD 78

HOLD 12

## I

Importing 93

Installing 86

## L

Labeling 41

Linear PCM 78

## M

Manual recording 28

MD Simple Burner 89

MDLP 27

Menu 22

Menu Mode 52

Move

groups 46  
tracks 45

My Library 93

## N

Net MD 89

## O

OpenMG Secure Module x.x 104

## P

Play mode

Main Play Mode 34  
Repeat Play 37  
Sub Play Mode 37

## Q

Quick mode 54

## R

### Recording

- adding track marks 29
- analog 26
- digital 15
- from microphone 26
- level 28
- mode (Hi-MD/MDLP) 27

### Recording mode 90

### Recording mode (Bit rate) 94, 98

### Relabeling 43

## S

### Search 38

### Simple Mode 90

### SonicStage 93

### SonicStage Help 100

### Start (software)

- MD Simple Burner 91
- SonicStage 93

### Synchro-recording 31

### System environment 86

### System limitations 86

## T

### Time Mark 29

### Title 40

### Track mark

- Add (Divide) 49
- Erase (Combine) 49

### Transferring

- to the MD Walkman 95
- to your computer 97

## U

### Uninstalling 104

### USB cable 10

### USB port 86

## W

### Windows 2000 Professional 86, 91, 93, 100, 104

### Windows 98 Second Edition 86, 91, 93, 100, 104

### Windows Media Player 86

### Windows Millennium Edition 91, 93, 100, 104

### Windows XP Home Edition 86

### Windows XP Media Center Edition 86

### Windows XP Media Center Edition 2004 86

### Windows XP Professional 86

### WMA 86





Printed using VOC (Volatile Organic  
Compound)-free vegetable oil ink.

<http://www.sony.net/>

Printed in Malaysia



\* 3 2 6 6 4 6 6 1 3 \* (1)