

Technics

D	I	G	I	T	A	L	
E	N	S	E	M	B	L	E

SX-PR700

SX-PR700M



SX-PR900R

SX-PR900C

SX-PR900B



FOR YOUR SAFETY PLEASE READ THE FOLLOWING TEXT CAREFULLY. (for UNITED KINGDOM)

This appliance is supplied with a moulded three-pin mains plug for your safety and convenience. A 5 amp fuse is fitted in this plug. Should the fuse need to be replaced please ensure that the replacement fuse has a rating of 5 amps and that it is approved by ASTA or BSI to BS1362. Check for the ASTA mark  or the BSI mark  on the body of the fuse.

If the plug contains a removable fuse cover you must ensure that it is refitted when the fuse is replaced.

If you lose the fuse cover the plug must not be used until a replacement cover is obtained. A replacement fuse cover can be purchased from your local Panasonic/Technics Dealer.

IF THE FITTED MOULDED PLUG IS UNSUITABLE FOR THE SOCKET OUTLET IN YOUR HOME THEN THE FUSE SHOULD BE REMOVED AND THE PLUG CUT OFF AND DISPOSED OF SAFELY.

THERE IS A DANGER OF SEVERE ELECTRICAL SHOCK IF THE CUT-OFF PLUG IS INSERTED INTO ANY 13 AMP SOCKET.

If a new plug is to be fitted please observe the wiring code as shown below. If in any doubt please consult a qualified electrician.

IMPORTANT: —The wires in this mains lead are coloured in accordance with the following code:—

Blue: Neutral
Brown: Live

As the colours of the wires in the mains lead of this appliance may not correspond with the coloured markings identifying the terminals in your plug, proceed as follows.

The wire which is coloured BLUE must be connected to the terminal in the plug which is marked with the letter N or coloured BLACK.

The wire which is coloured BROWN must be connected to the terminal in the plug which is marked with the letter L or coloured RED.

Under no circumstances should either of these wires be connected to the earth terminal of the three-pin plug, marked with the letter E or the Earth Symbol .

How to replace the fuse. Open the fuse compartment with a screwdriver and replace the fuse and fuse cover.

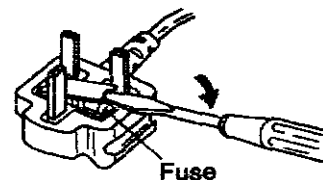

Technics

OWNER'S MANUAL



Caution

Voltage (except North America, Mexico, Europe, Australia, New Zealand and Philippines)

Be sure the voltage adjuster located on the rear panel is in accordance with local voltage in your area before using this unit. Use a screwdriver to set the voltage adjuster to the local voltage.

WARNING: TO REDUCE THE RISK OF FIRE OR ELECTRICAL SHOCK, DO NOT EXPOSE THIS PRODUCT TO RAIN OR MOISTURE.

BEFORE YOU PLAY, PLEASE READ THE CAUTIONARY COPY APPEARING ON PAGE 2.

	CAUTION RISK OF ELECTRIC SHOCK DO NOT OPEN	
CAUTION:	TO REDUCE THE RISK OF ELECTRIC SHOCK, DO NOT REMOVE SCREWS. NO USER-SERVICEABLE PARTS INSIDE. REFER SERVICING TO QUALIFIED SERVICE PERSONNEL.	



The lightning flash with arrowhead symbol, within an equilateral triangle, is intended to alert the user to the presence of uninsulated "dangerous voltage" within the product's enclosure that may be of sufficient magnitude to constitute a risk of electric shock to persons.



The exclamation point within an equilateral triangle is intended to alert the user to the presence of important operating and maintenance (servicing) instructions in the literature accompanying the appliance.

Before you play

For long and pleasurable use of this instrument, and to gain a thorough understanding of your PR series Digital Ensemble, it is strongly recommended that you read through this Owner's Manual once.

The Owner's Manual is comprised of the following parts.

BASIC FUNCTIONS	This part includes an explanation of basic procedures and points you should be aware of for proper operation of your instrument.
PRACTICAL APPLICATIONS	This part comprises a detailed explanation of sound, effect, rhythm, SEQUENCER , COMPOSER , Disk Drive and MIDI.
REFERENCE GUIDE (separate booklet)	Reference guide for the contents of the SOUND GROUP , RHYTHM GROUP , MIDI data, etc.

Cautions for safest use of this unit

Installation location

1. A well-ventilated place.
Take care not to use this unit in a place where it will not receive sufficient ventilation, and not to permit the ventilation holes to be covered by curtains, or any similar materials.
2. Place away from direct sunlight and excessive heat from heating equipment.
3. A place where humidity, vibration and dust are minimized.

Power source

1. Be sure the line voltage selector is in accordance with local voltage in your area before connecting the plug to the socket.
2. DC power cannot be used.

Handling the power cord

1. Never touch the power cord, or its plug, with wet hands.
2. Don't pull the power cord.

Metal items inside the unit may result in electric shock or damage.

Do not permit metal articles to get inside the unit.

Be especially careful with regard to this point if children are near this unit. They should be warned never to try to put anything inside.

If, nevertheless, some such article does get inside, disconnect the power cord plug from the electrical outlet, and contact the store where the unit was purchased.

If water gets into the unit

Disconnect the power cord plug from the electrical outlet, and contact the store where it was purchased.

As a precaution, it is suggested that flower vases and other containers which hold liquids not be placed on the top of this unit.

If operation seems abnormal

Immediately turn off the power, disconnect the power cord plug from the electrical outlet, and contact the store where it was purchased.

Discontinue using the unit at once. Failure to do so may result in additional damage or some other unexpected damage or accident.

- Because the power source is located inside the unit, it is normal for the cabinet to become warm.

A word about the power cord

If the power cord is scarred, is partially cut or broken, or has a bad contact, it may cause a fire or serious electrical shock if used. NEVER use a damaged power cord for any appliance. Moreover, the power cord should never be forcibly bent.

Don't touch the inside parts of this unit.

Some places inside this unit have high voltage potential. Never try to remove the top or back panels of this unit, or to touch inside parts by hand or with tools.

Contact someone who is qualified in order to inspect the inside, or to replace a fuse, if such becomes necessary. Never attempt to do these things yourself.

Maintenance

The following suggestions will assist you in keeping the unit in top condition.

- Be sure to switch the instrument off after use, and do not switch the unit on and off in quick succession, as this places an undue load on the electronic components.
- To keep the luster of the surface and buttons, simply use a clean, damp cloth; polish with a soft, dry cloth. Polish may be used but do not use thinners or petro-chemical-based polishes.
- A wax-based polish may be used on the cabinet, although you will find that rubbing with a soft cloth will suffice.

**SERVICE MUST BE CARRIED OUT BY DEALER
OR OTHER QUALIFIED PERSON**

Contents

Cautions for safest use of this unit	2
Controls and functions (PR700)	6
Controls and functions (PR900)	8

BASIC FUNCTIONS

Getting started	10
Listen to the demonstration	11
Playing the piano	13
Selecting other sounds	14
Playing automatic rhythms	15
Automatic accompaniment	18
Playing commercial disks	20

PRACTICAL APPLICATIONS

About the display	22
Part I Sounds and effects	27
Play Style	27
Conductor	28
Selecting sounds	28
Digital Drawbar (PR900)	30
Mixing two sounds	32
Keyboard split	32
Pedals	34
Effects	36
Transpose	38
Techni-chord	39

Part II Playing the rhythm	40
Selecting rhythms	40
Playing the rhythm	42
Auto Play Chord	43
Piano Stylist	47
One Touch Play	48
Music Style Select	49
Music Style Arranger	50
Panel Memory	51
Pedal setting	53
Part III Sequencer	54
Outline of the Sequencer	54
Song Select & Name	56
Easy Record	57
Sequencer parts	58
Realttime Record	59
Sequencer Play	61
Step Record	63
Track Assign	69
Editing the recorded performance	70
Punch Record	81
Sequencer Medley	83
Part IV Composer	84
Outline of the Composer	84
Simple recording method	86
Edit a preset rhythm pattern: preparation	87
Create a completely new rhythm: preparation	88
Sequencer to Composer Copy	90
Record your rhythm pattern	91
Playback	92
Step Record	93
Composer mode	94
Composer Chord Map	95

Part V Disk Drive	97
Outline of the Disk Drive function	97
Outline of procedure	98
Loading data	99
Playing commercial disks	101
Formatting a disk	102
Saving data	103
Part VI Adjusting the sounds	106
Sound mode	106
Part Setting	107
Mixer	112
Overall Touch Sensitivity	113
Master Tuning	113
Key Scaling	114
Techni-chord Type	115
Left Hold	116
Reverb	117
DSP Effect	117
Part VII MIDI	118
What is MIDI?	118
Outline of MIDI functions	120
Setting the functions	121
Initialize	127
Connections	129
Assembly (PR700)	130
Assembly (PR900)	131
Symptoms which appear to be signs of trouble	132
Error messages	135
Index	136
Specifications	138

Controls and functions (PR700)

PLAY STYLE

Select standard piano or one of various other performance styles. (Refer to page 27.)

COMPOSER

Create and store original rhythm patterns. (Refer to page 84.)

RHYTHM GROUP

Choose preset automatic rhythm patterns. (Refer to page 40.)

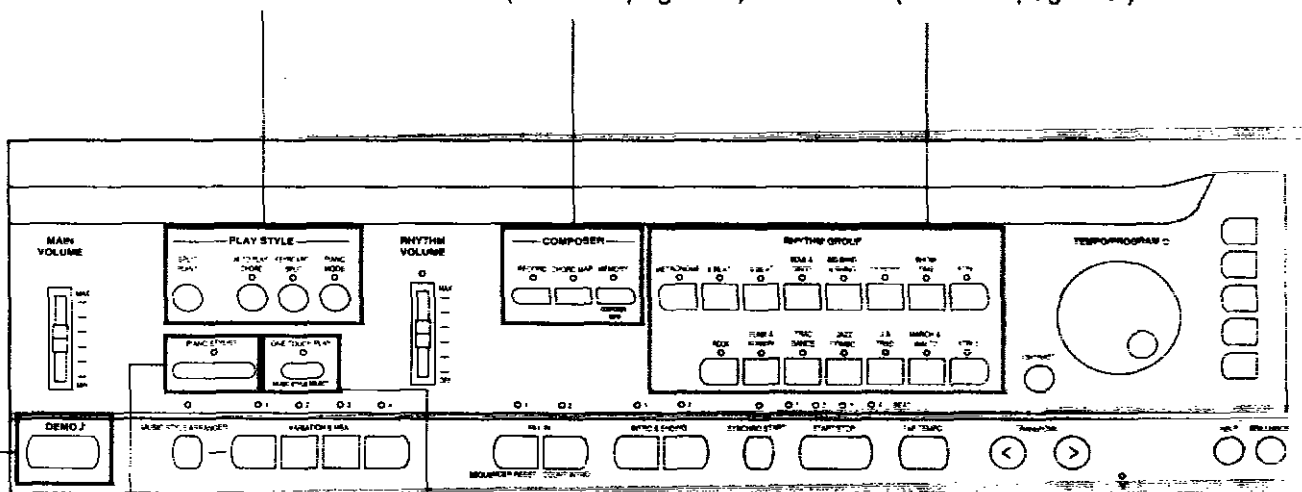

DEMO

You can listen to programmed demonstration tunes which show what your Digital Ensemble can do. (Refer to page 11.)

PIANO STYLIST

For performances using piano sounds, just select a piano style, and in seconds an appropriate panel registration is set, including the accompaniment pattern. (Refer to page 47.)

ONE TOUCH PLAY

Sounds and effects which fit the selected rhythm are automatically selected. (Refer to page 48.)

Tuning

Unlike an acoustic piano, your PR Series Digital Ensemble never needs tuning.

- The pitch of this instrument can be adjusted for when playing along with other instruments. (Refer to page 113.)

Effects

Add various effects to the sounds. (Refer to page 36.)

SOUND GROUP

You can select from four piano-type sounds. Or choose the sounds of various instruments. (Refer to page 29.)

SEQUENCER

Record and play back your performance. (Refer to page 54.)

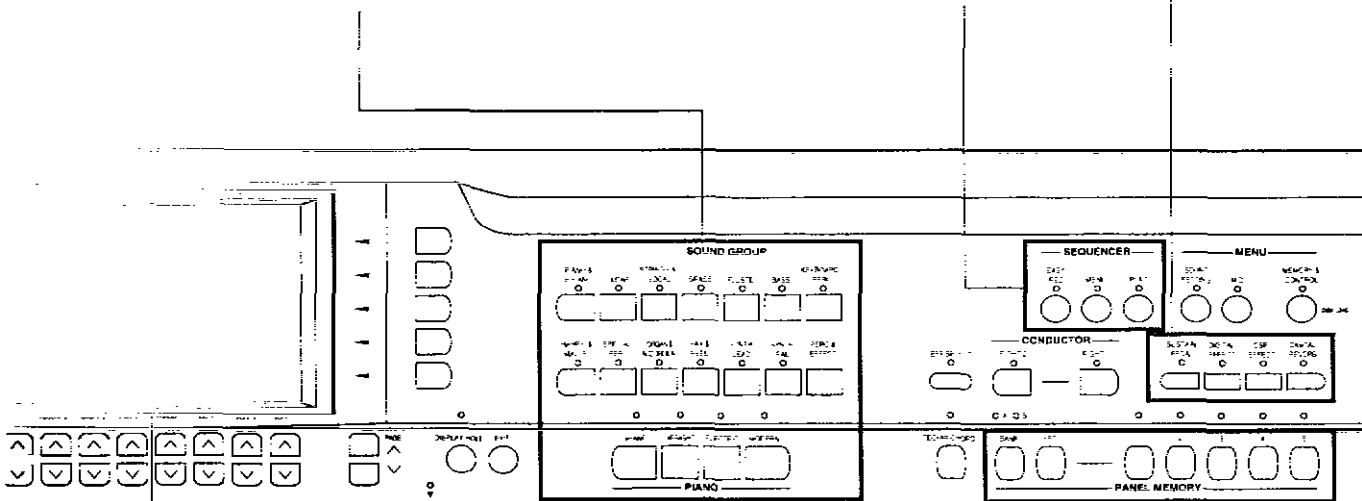

DISPLAY (LCD screen)

Displays performance information, function settings and other messages.

(Refer to page 22.)

- Use the **CONTRAST** button to adjust the display so that it is easy to read. (Refer to page 25.)

PANEL MEMORY

Store the current panel settings for instant recall.

(Refer to page 51.)

■ About the backup memory

The settings and memories are maintained for approximately 80 minutes after the power to this instrument is turned off. If you wish to keep the memory contents, before you turn off the instrument, use the **SAVE** procedure to store the desired data on a disk for recall at a later time.

- The backup memory does not function until the power has been on for about 10 minutes.
- When you quit the operating mode, a warning display may appear to remind you to save the data.

Controls and functions (PR900)

PLAY STYLE

Select standard piano or one of various other performance styles.
(Refer to page 27.)

COMPOSER

Create and store original rhythm patterns.
(Refer to page 84.)

RHYTHM GROUP

Choose preset automatic rhythm patterns.
(Refer to page 40.)

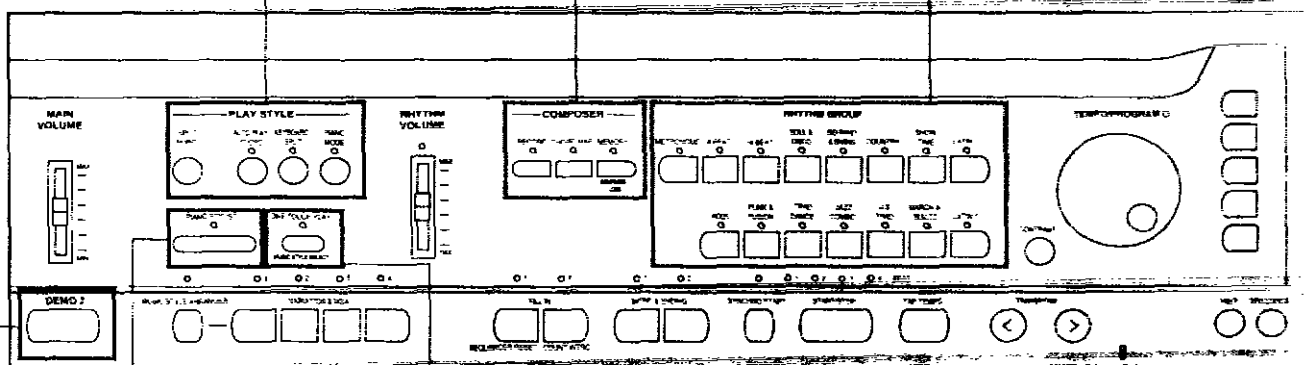

DEMO

You can listen to programmed demonstration tunes which show what your Digital Ensemble can do.
(Refer to page 11.)

PIANO STYLIST

For performances using piano sounds, just select a piano style, and in seconds an appropriate panel registration is set, including the accompaniment pattern.
(Refer to page 47.)

ONE TOUCH PLAY

Sounds and effects which fit the selected rhythm are automatically selected.
(Refer to page 48.)

Care and maintenance

■ Care of the finished surfaces

- To dust the piano, use a feather duster or wipe gently with a soft cloth.
- To avoid scratching the surface, refrain from applying too much pressure when dusting the piano.

Never use petroleum-based solvents such as thinner or benzine, and do not use chemically treated dust cloths, as these products will damage the finish of your piano.

■ Caution for use

- Do not place vinyl products, books with vinyl-treated covers, plastic erases, etc., directly on the piano.
- Do not place vases or other containers of liquids on the piano.
- Please read the safety instructions on page 2.

DISPLAY (LCD screen)

Displays performance information, function settings and other messages.

(Refer to page 22.)

- Use the **CONTRAST** button to adjust the display so that it is easy to read.
(Refer to page 25.)

SEQUENCER

Record and play back your performance.

(Refer to page 54.)

SOUND GROUP

You can select from four piano-type sounds. Or choose the sounds of various instruments.
(Refer to page 29.)

Effects

Add various effects to the sounds. (Refer to page 36.)

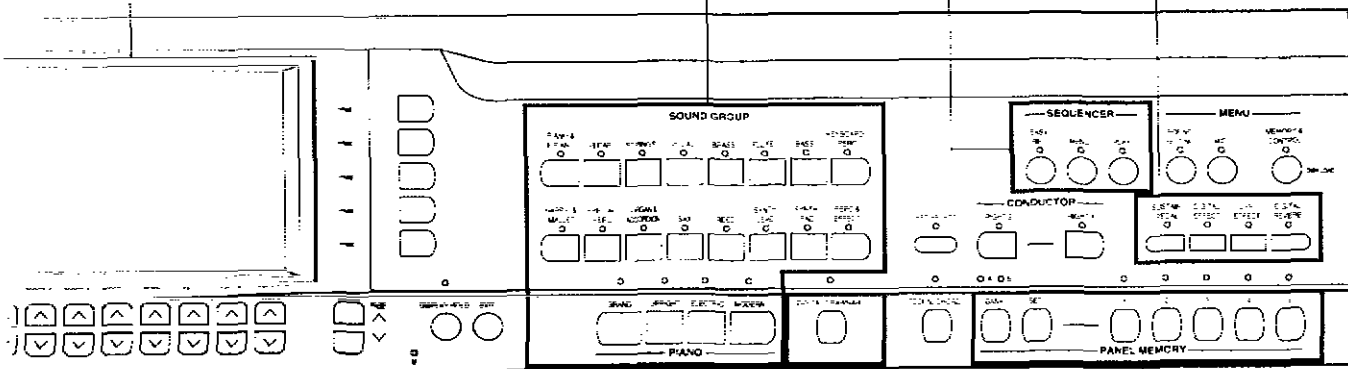

DIGITAL DRAWBAR

Select authentic drawbar organ sounds.
(Refer to page 30.)

PANEL MEMORY

Store the current panel settings for instant recall.
(Refer to page 51.)

■ Tuning

Unlike an acoustic piano, your PR Series Digital Ensemble never needs tuning.

- The pitch of this instrument can be adjusted for when playing along with other instruments. (Refer to page 113.)

■ About the backup memory

The settings and memories are maintained for approximately 80 minutes after the power to this instrument is turned off. If you wish to keep the memory contents, before you turn off the instrument, use the **SAVE** procedure to store the desired data on a disk for recall at a later time.

- The backup memory does not function until the power has been on for about 10 minutes.
- When you quit the operating mode, a warning display may appear to remind you to save the data.

Getting started

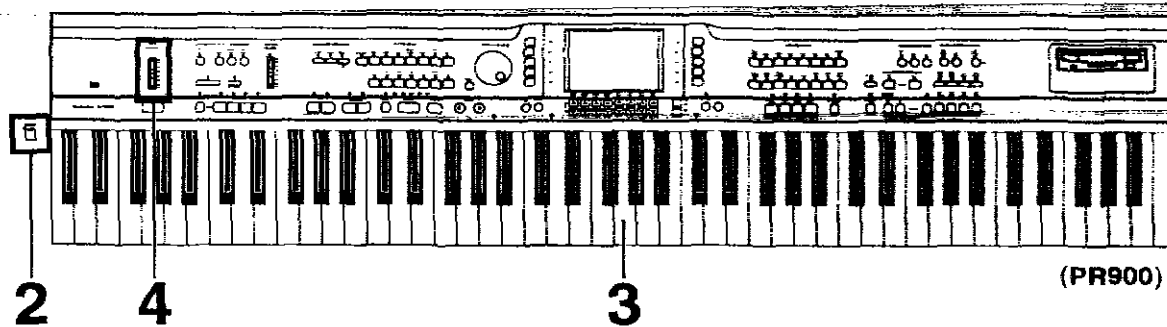

1 Plug the power cord into an outlet.

2 Press the **POWER** button to turn it on.

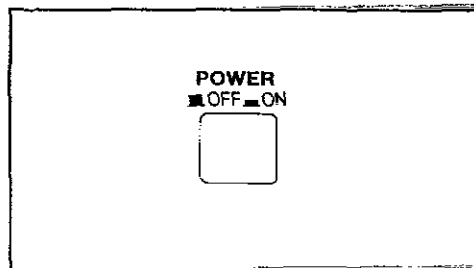

3 Touch any note on the keyboard. You will hear a **PIANO** sound.

- Your piano features Touch Response. You control the volume by playing the keys harder or softer.

4 Set the **MAIN VOLUME** to an appropriate level with the sliding control.

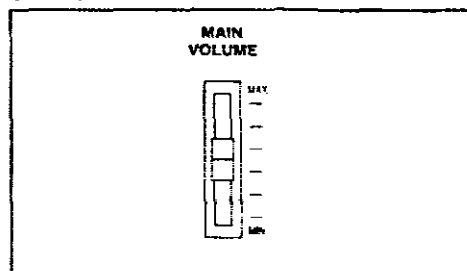

Keyboard cover

Open and close the cover slowly.

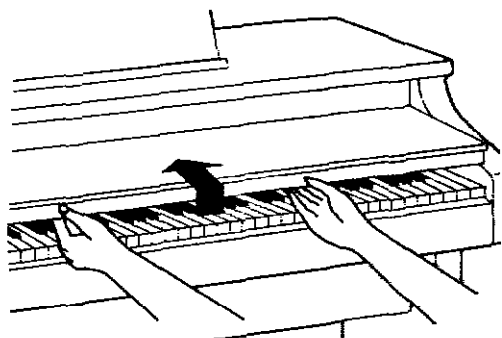

Music Stand

To set up the music stand, gently raise it from its folded down position.

To lower the music stand, first fold in the metal support at the rear of the stand, and then lower the stand gently.



Listen to the demonstration

Listen to a particular sound or rhythm demonstration.

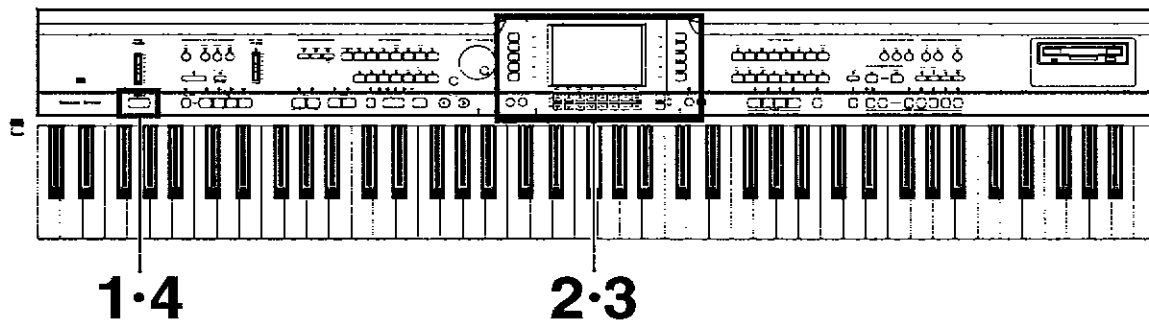

1 Press the **DEMO** button.

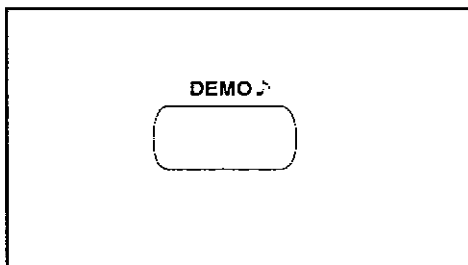

- The display changes to the DEMONSTRATION display.

2 Use the buttons to the right of the display to select **PIANO**, **SOUND** or **RHYTHM**.

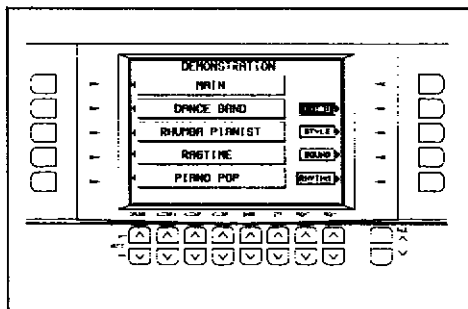

- The display changes.

3 Use the buttons to the left of the display to select the sound or rhythm demonstration performance you wish to hear.

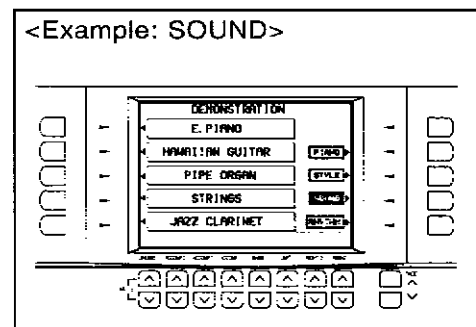

- The demonstration performance corresponding to your selection begins.
- To end the demonstration before it has finished, again press the button for the selected sound or rhythm.
- Repeat this procedure to listen to other sounds and rhythms.

4 When you are finished listening to the demonstration tunes, press the **DEMO** button again.

Listen to the style demonstration performance.

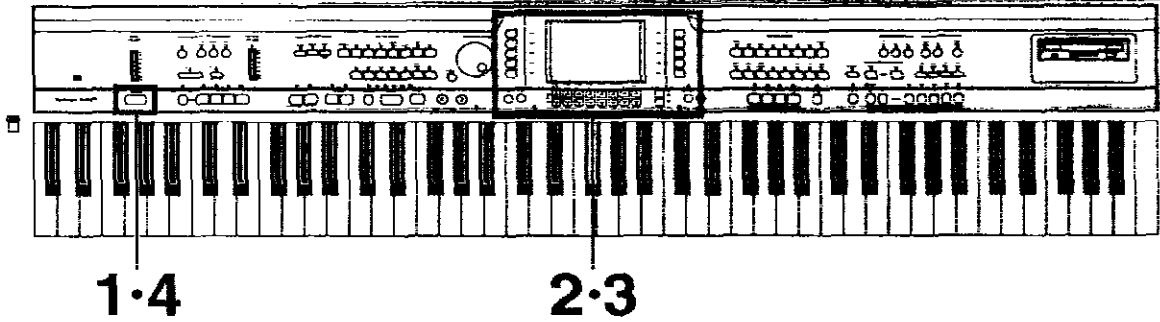

1

Press the **DEMO** button.

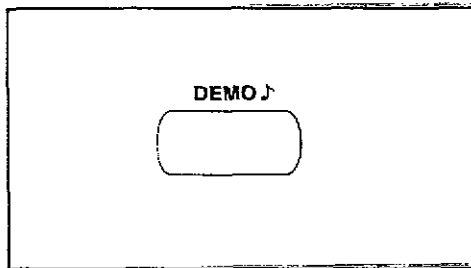

- The display changes to the **DEMONSTRATION** display.

2

Select **STYLE** from the display.

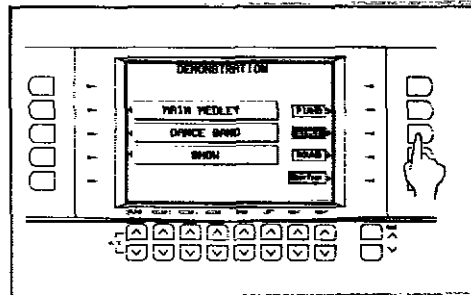

- The display changes.

3

Use the buttons to the left of the display to select the style demonstration performance you wish to hear.

- The demonstration performance corresponding to your selection will begin.
- Repeat this procedure to listen to other styles.

4

When you are finished listening to the demonstration tunes, press the **DEMO** button again.

- If you press and hold the **DEMO** button for a few seconds, or if you press first the **DEMO** button and then the **START/STOP** button, the sounds, rhythms and styles are demonstrated in order in a medley performance. The medley performance continues until the **START/STOP** button or the **DEMO** button is pressed again.

- During the medley performance, if you wish to skip from the current song to the next song, press the button for the highlighted song.
- Some of the buttons do not function while the demonstration performances are being played.
- The name of the current demonstration tune is highlighted.

Playing the piano

Your piano is equipped with various fine functions which make it an extremely versatile instrument. But it should be remembered that it is first of all a fine piano. Select one of the piano sounds and enjoy its excellent quality.

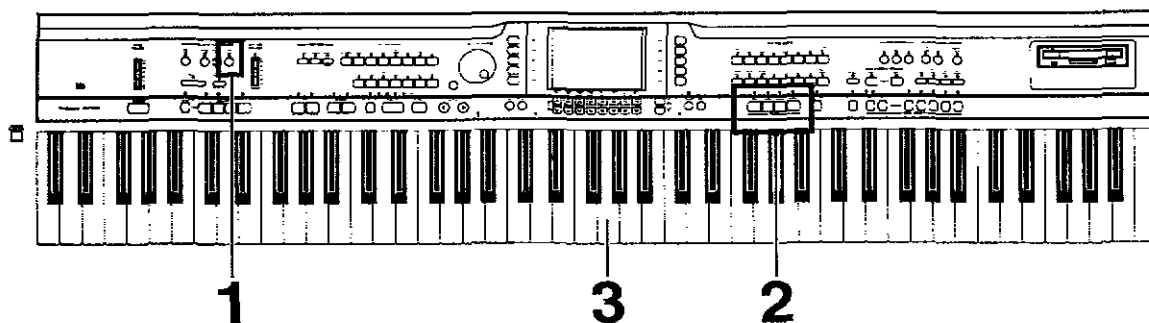

- 1 In the **PLAY STYLE** section, press the **PIANO MODE** button to turn it on.

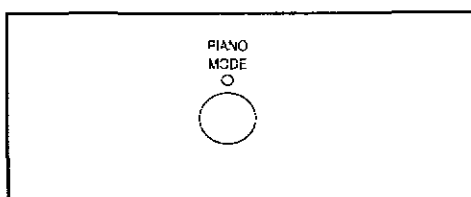

- The indicator lights.
- **PIANO MODE** is the default selection when the instrument is first turned on.

- 2 Select one of the four **PIANO** sounds by pressing the corresponding button.

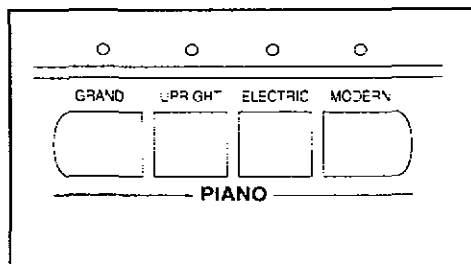

- 3 Play anywhere on the keyboard.

Selecting other sounds

In addition to piano sounds, this instrument is provided with the colorful sounds of various other instruments.

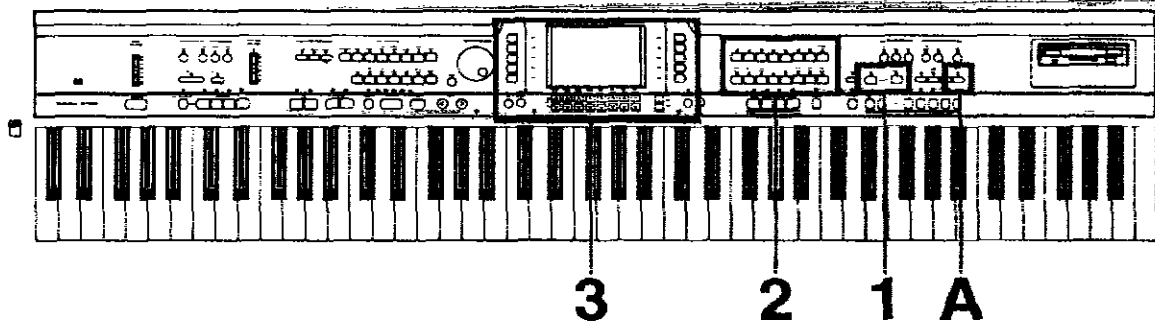

- 1** In the **CONDUCTOR** section, press the **RIGHT1** button.

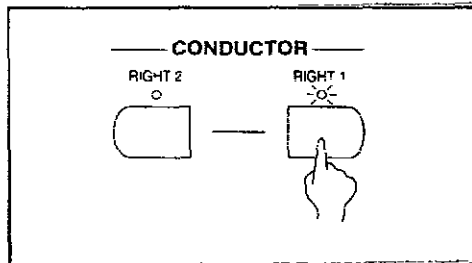

- 2** In the **SOUND GROUP** section, select a sound group.

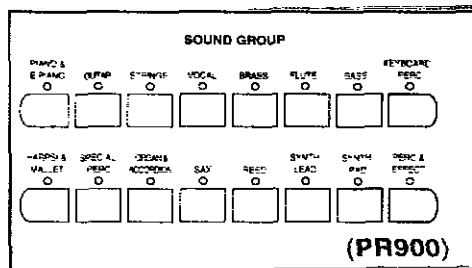

- The display changes.

- 3** Select a sound from the list on the display.

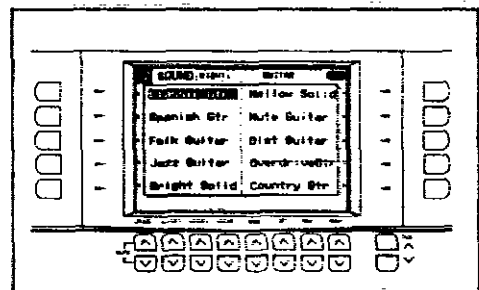

- To see a different part of the list, press either **PAGE** button.
- After a few seconds, the display returns to the previous display.

Add reverb to the sound.

- A** Press the **DIGITAL REVERB** button to turn it on.

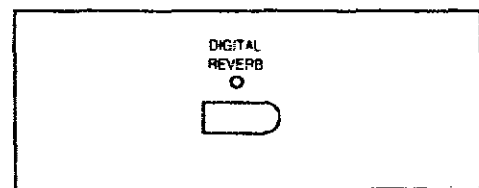

- The indicator lights.

- When one of these sounds is selected, the **PIANO MODE** indicator in the **PLAY STYLE** section automatically turns off.

- Other things you can do are mixing sounds and playing different sounds on the left and right areas of the keyboard. (Refer to page 32.)

Playing automatic rhythms

Listen to preset rhythms.

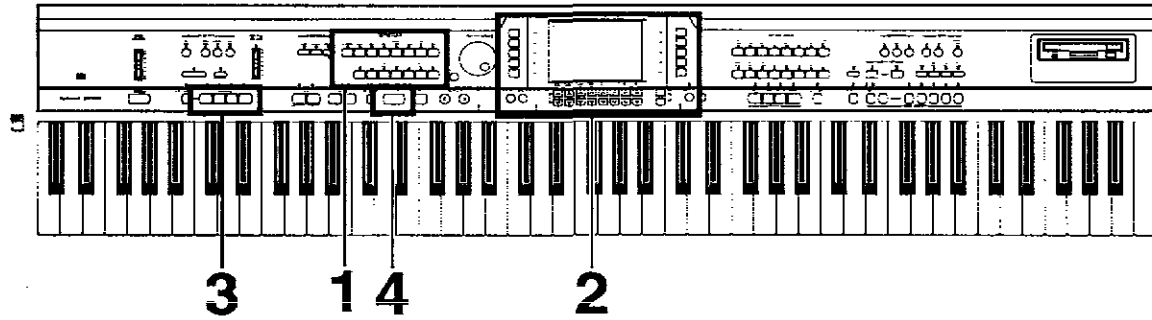

1 In the **RHYTHM GROUP** section, select a rhythm group.

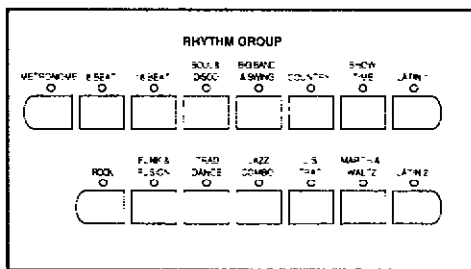

- The display changes.

2 Select a rhythm from the display.

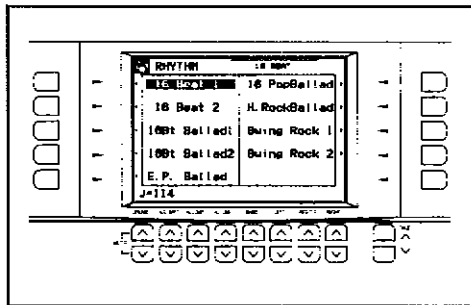

- The display returns to the previous display after a few seconds.

3 Use the **VARIATION** buttons to select the variation number.

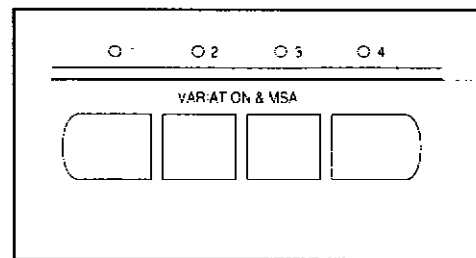

- The nuance of the pattern differs with each variation number.

4 Start the rhythm by pressing the **START/STOP** button.

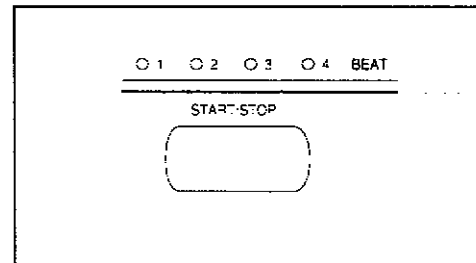

- Stop the rhythm by pressing the **START/STOP** button again.

Control the rhythm.

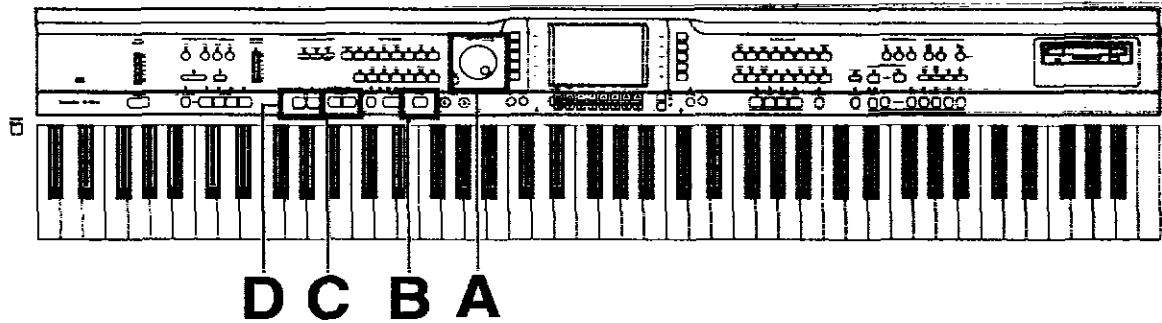

Adjust the tempo.

A

Adjust the tempo with the TEMPO/PROGRAM dial.

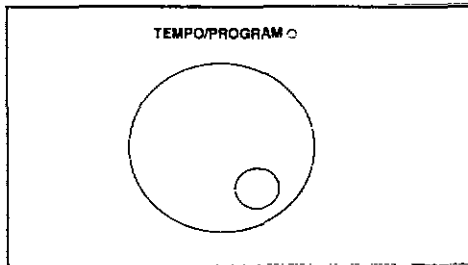

- The tempo is shown in the display as "♩ = ".

Insert an intro pattern.

C

To start your performance with an introduction, press the **INTRO & ENDING 1** or **INTRO & ENDING 2** button before starting the rhythm.

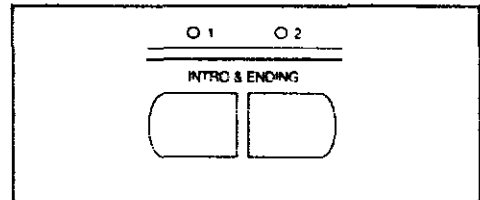

- An intro is played, after which the regular rhythm starts.

Adjust the tempo with your finger.

B

You can set the tempo of the rhythm by tapping the **TAP TEMPO** button few times with your finger.

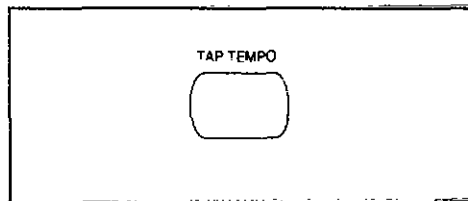

- The tempo at which the button is tapped is detected, and the tempo automatically changes correspondingly.

Insert a fill-in pattern.

D

While the preset rhythm pattern is playing, press either the **FILL IN 1** or **FILL IN 2** button.

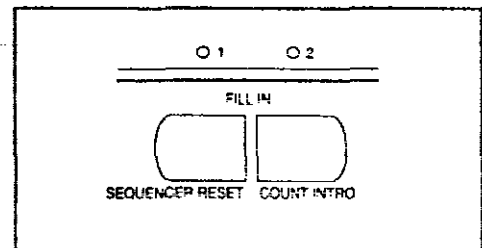

- A fill-in pattern immediately starts to play.

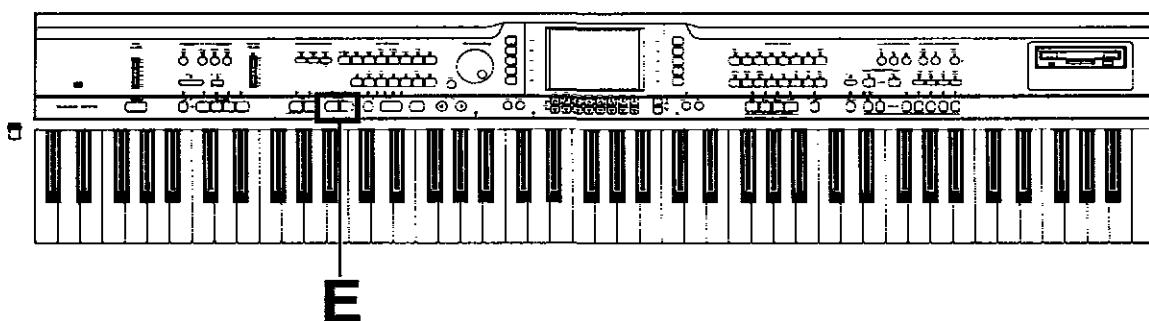

Insert an ending pattern.

E While the rhythm is playing, press the **INTRO & ENDING 1** or **INTRO & ENDING 2** button.

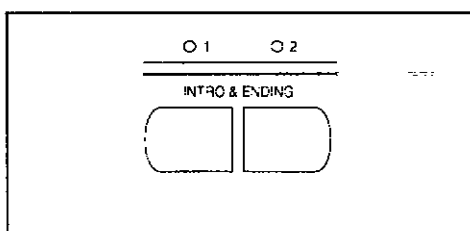

- You will hear an ending pattern, and then the rhythm stops.

Automatic accompaniment

Just by specifying a chord on the keyboard, an accompaniment pattern which matches the selected rhythm is automatically played.

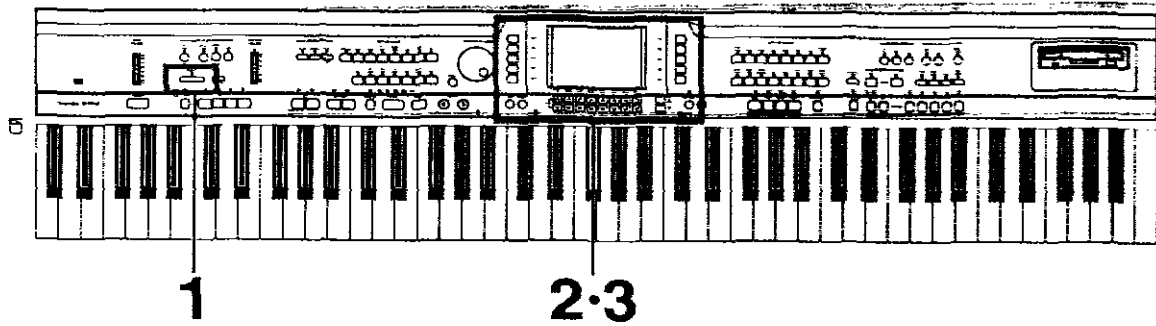

Use the **PIANO STYLIST** with the following tune.



1 Press the **PIANO STYLIST** button to turn it on.

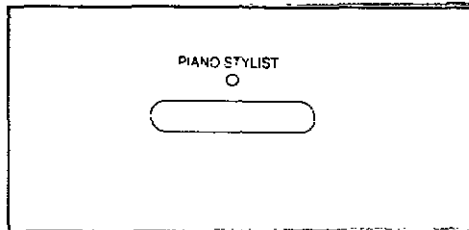

3 Use the \wedge and \vee buttons to select a style.

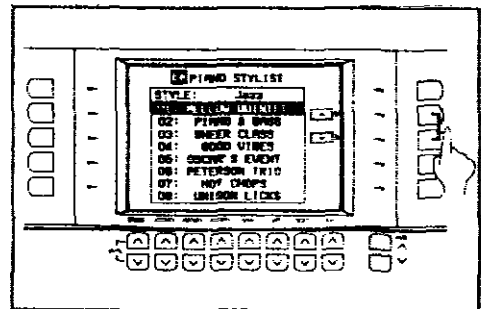

2 Select a style group from the display.

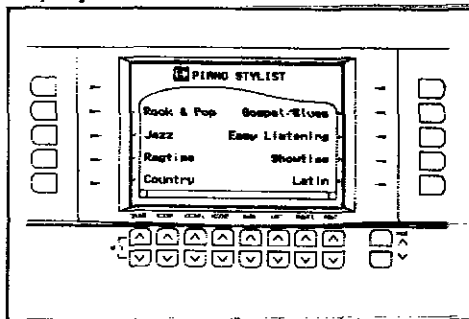

- The panel settings which are best suited for the selected style are automatically set.

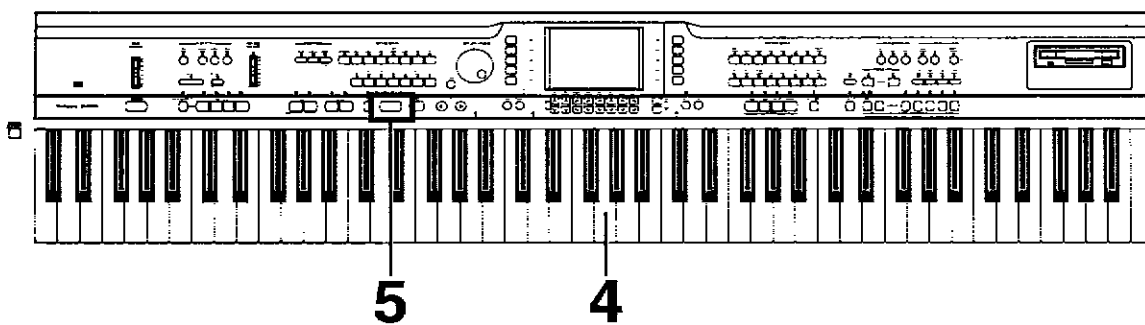

4 Use your left hand to play the chords and your right hand to play the melody.

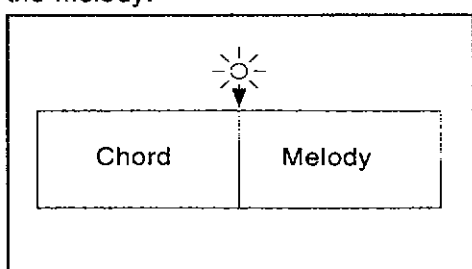

- When you press a key on the left area of the keyboard, an intro is played, after which the automatic rhythm is played (synchro start).
- When the C key is pressed on the left area of the keyboard, an accompaniment begins to play in the C major key.
- Playing the chord key (root note) and the white key to its left will produce a 7th chord.

5 At the end of your performance, press the **START/STOP** button.

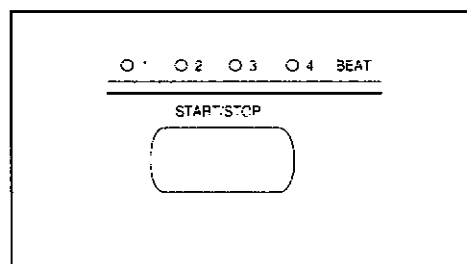

- The automatic accompaniment stops.

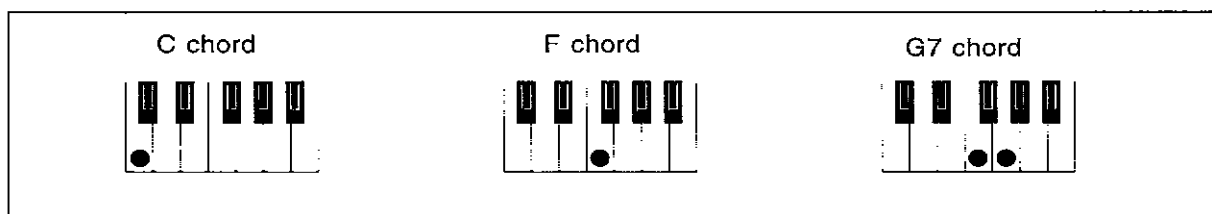

- The **PIANO STYLIST** feature explained in this chapter makes it easy to set up a performance, including rhythm, for piano sounds. Other features change the panel settings to automatically match the rhythm and music style you select. (Refer to pages 48 and 49.)

- For a more detailed explanation on how to play chords, etc., refer to the section on the **AUTO PLAY CHORD** (page 43).

Playing commercial disks

You can play commercial song disks such as Standard MIDI File (SMF) FORMAT 0 disks on this instrument.

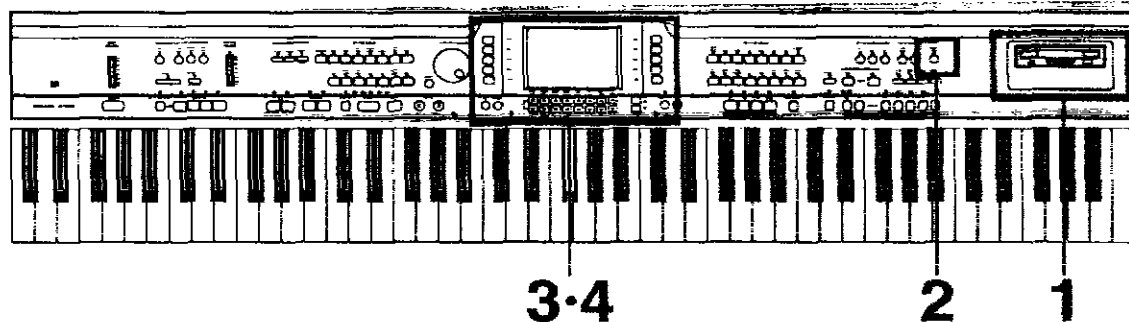

1 Insert the song disk into the Disk Drive slot.

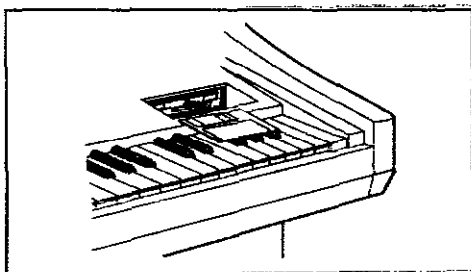

- Push it all the way in until you hear a click.

2 Press the **MEMORY & CONTROL** button to turn it on.

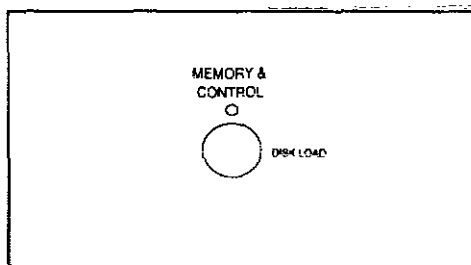

- The display changes to the **MEMORY & CONTROL** display.

3 Press the button next to the display to select **DIRECT PLAY**.

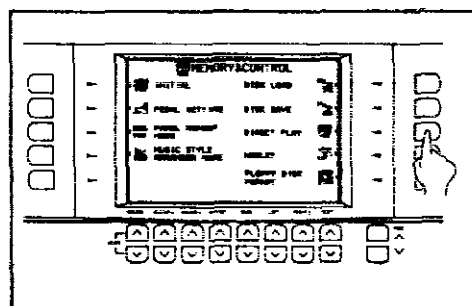

- The display changes to the **DIRECT PLAY** display.

4 Select the song list column, and use the \wedge and \vee buttons to select the song to play back.

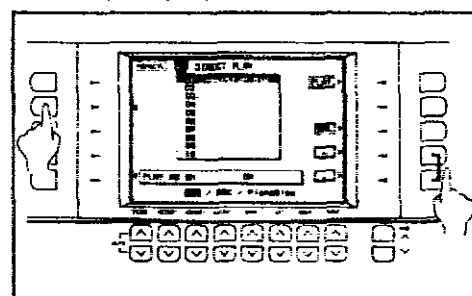

- You can select the **PLAY AS GM** column, and use the \wedge and \vee buttons to specify whether or not (ON/OFF) the song is played back as GM (GENERAL MIDI).

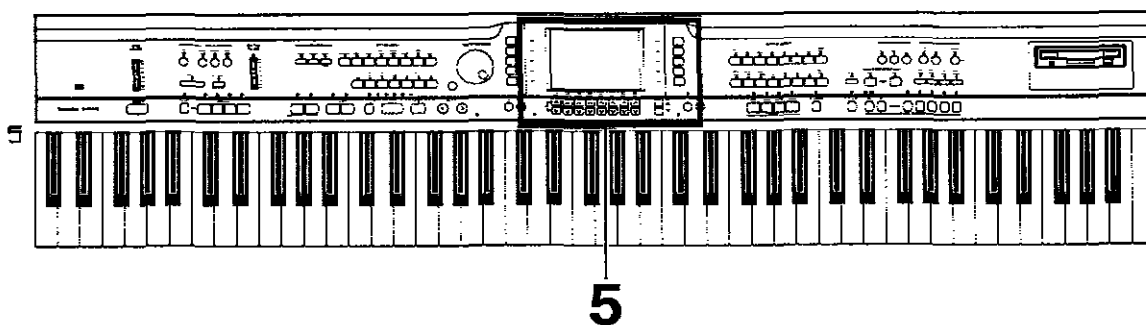

5

Press the PLAY button.

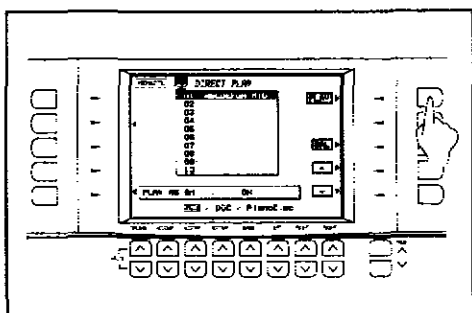

- The selected song is played back.
- To adjust the volume balance, press the BAL button.
- The PLAY button becomes the STOP button. Press this button if you wish to stop playback before it has finished.

- You can use the same procedure to play back other songs on the disk.
- Direct play from SMF FORMAT 1 disks is not possible. To play FORMAT 1 disks, follow the LOAD procedure (page 100).

About the display

The display shows various information and is used for most of this instrument's operations.

Normal display

This illustration shows the kind of information you see on the display during a normal performance.

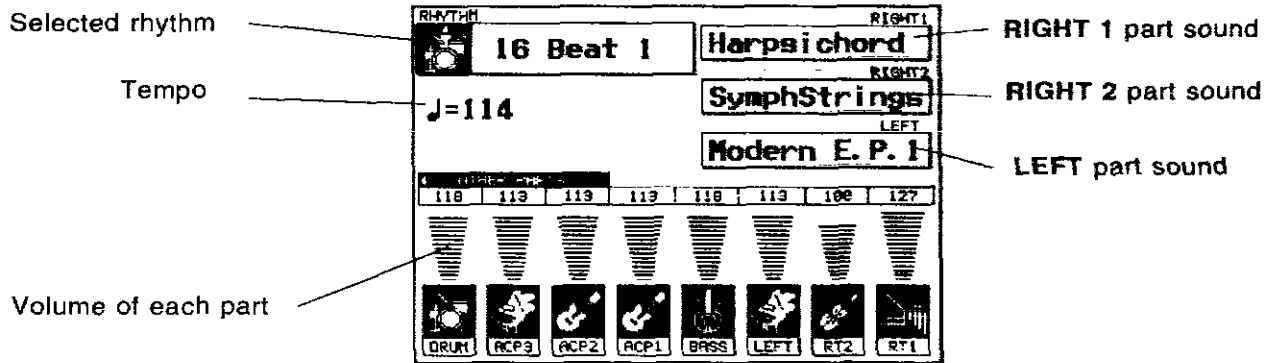

Volume balance

At the bottom half of the normal display, the volume balance of each part is shown as a bar graph and a number (0 to 127).

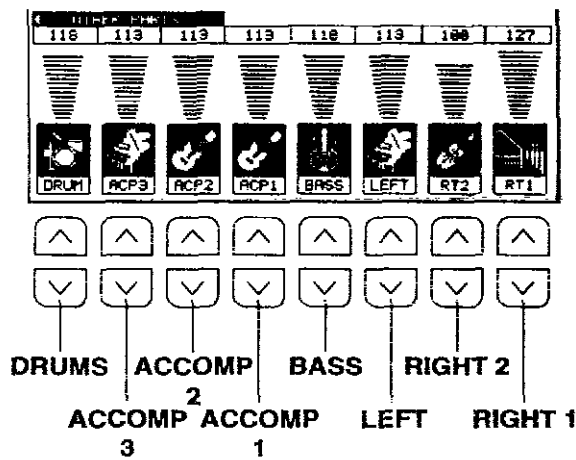

Use the ^ and v buttons directly below the display to adjust the volume of each part.

- You can press and hold a button to change the volume quickly.

■ MUTE

To mute a part, press both the corresponding ^ and v buttons at the same time.

- The volume display for a muted part is shown as "MUTE."
- Pressing either balance button for a muted part will cancel the mute function.

■ **OTHER PARTS**

If you press the button for OTHER PARTS, the display changes to show the volumes of other parts.

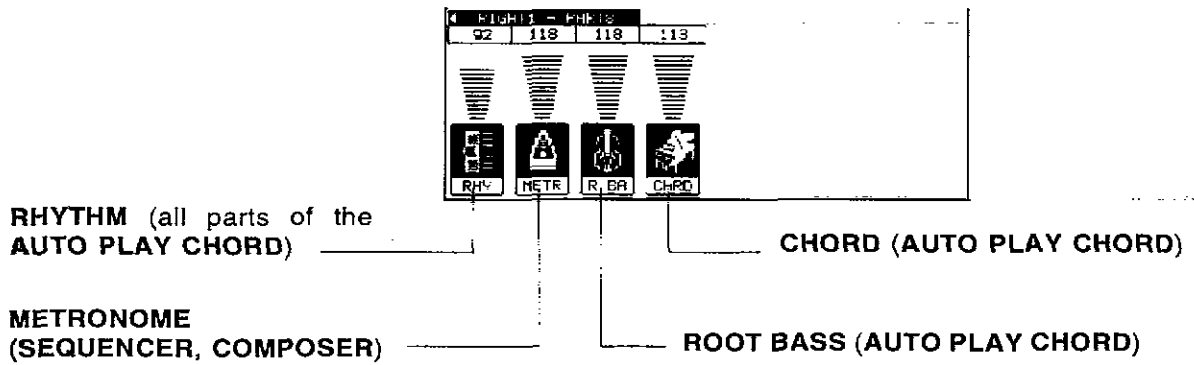

- Press the EXIT button to return to the normal volume display.
- This button is also used to access the RIGHT1-PART8 volume display and the PART9-16 volume display. These parts are used in conjunction with SEQUENCER and MIDI functions.

PAGE buttons

When there are additional parts to the current display, a page number indication appears in the upper right corner of the screen. For example, if "PAGE1/2" or "P1/2" is shown, it means that there are two pages of the display, and the current page is page 1. In this case, you can use the PAGE ^ and v buttons to the right of the balance buttons to view different "pages" of the display.

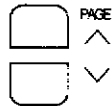

- Press the ^ button to view the next page of the display, and the v button to view the previous page of the display.

MENU displays

The buttons such as those shown in the illustration below control multiple functions. Pressing one of the buttons will access the corresponding MENU display.

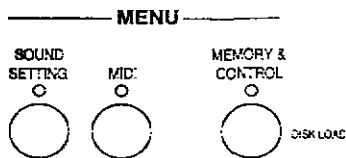

■ **Example of a MENU display: SOUND SETTING**

Select a function from the **MENU** display by pressing the corresponding button to the left or right of the display indicated by the ◀ and ▶ arrows.

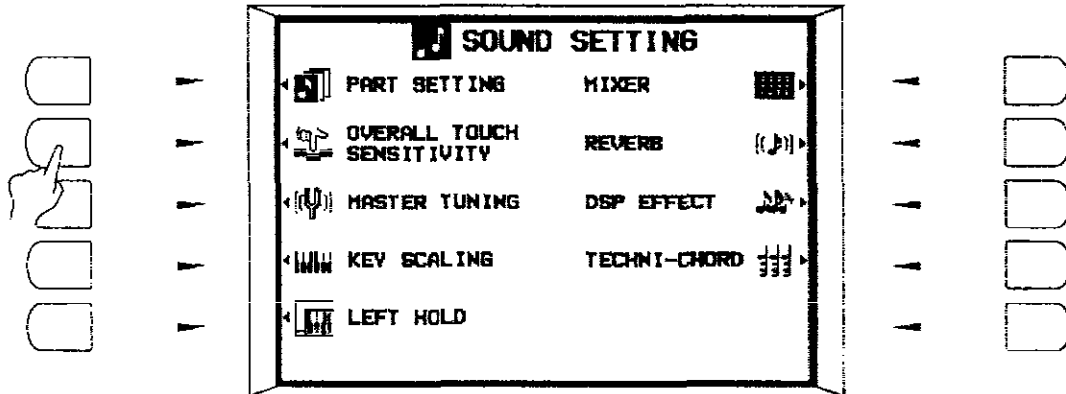

- In this manual, the steps describing how to select a function from a **MENU** display are generally abbreviated as follows, for example: "On the **SOUND** menu display, select **OVERALL TOUCH SENSITIVITY**." (See illustration above.)

Setting display

When setting various functions, the available options are shown on the display. The buttons to the right, left and/or directly below the display are used to select and adjust the settings.

■ **Example of a setting display: OVERALL TOUCH SENSITIVITY**

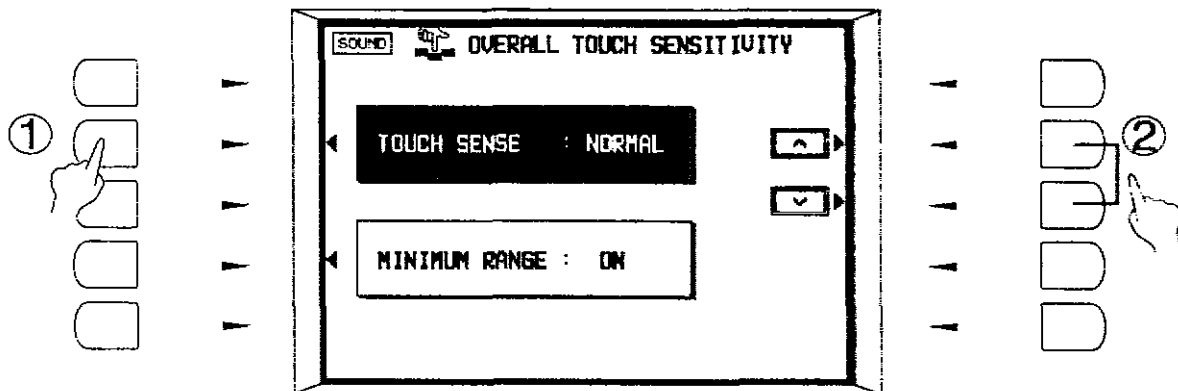

<Example of the procedure to set a function>

- ① In the illustration above, two functions are shown on the setting display: **TOUCH SENSE** and **MINIMUM RANGE**. First, select one of the functions by pressing the corresponding button indicated by the ◀ arrow. (The currently selected function is highlighted.)
- In this manual, the procedure to indicate that you should press a button to select an item from the display is generally written simply as follows: "Select **TOUCH SENSE**."

- ② The ^ and v buttons on the display are operated by pressing the corresponding buttons indicated by the ▶ arrows. These buttons are used, when appropriate, to change the setting for the selected function.
- In this manual, this procedure is written as follows: "Use the ^ and v buttons to select the type."

EXIT button

While the setting display is shown, press this button to go back to the previous display.



DISPLAY HOLD button

Press this button to turn it on when you wish to maintain the current display. For example, you can maintain a setting display which normally turns off automatically, or even during a performance you can monitor information which is not shown on the normal performance display.

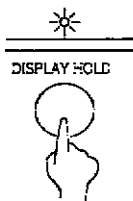

- If you are viewing a setting display which normally turns off automatically, this indicator may flash.
- If any of the **MENU** buttons, for example, is pressed, the **DISPLAY HOLD** mode is canceled.

CONTRAST

Adjust the contrast of the display.

1. Press the **CONTRAST** button.



- The LCD **CONTRAST** display appears.

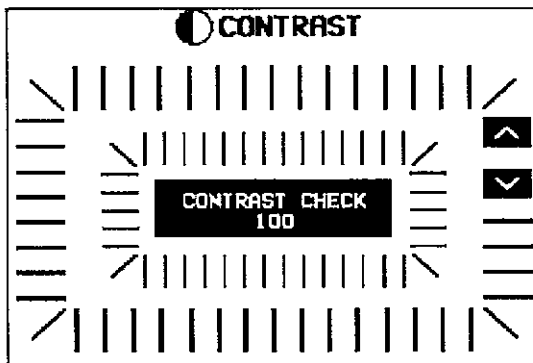

2. Use the \wedge and \vee buttons to adjust the setting (1 to 100).

- The higher the number the lighter the display characters.
- Each time the **CONTRAST** button is pressed, the number is incremented by 10, allowing you to speedily set the desired contrast.

3. When you have finished making the settings, press the **EXIT** button.

TEMPO/PROGRAM dial

If the **TEMPO/PROGRAM** indicator is lit while you are using the display to adjust a setting, it indicates that the dial may be used to change the displayed value or setting.

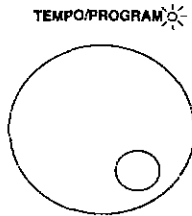

HELP display

You can find an explanation of each button's function on the display.

1. While the normal performance display is shown, press the **HELP** button (at the lower left of the display).



2. Press a button on the panel to show an explanation of the button's function on the display.

3. When you have finished reading the message, press the **HELP** button again.

- The following display appears.

```
HELP FUNCTION
Press any button on the PR and the
screen will give you information about
the button's function

<<LANGUAGE SELECT>>
You can select the language in which to
display the HELP information.
To do this press the LANGUAGE button
under the screen.

<<Exit HELP>>
Press HELP or EXIT to turn off the HELP
function.

/ ENGLISH / GERMAN / FRENCH /
```

The appearance of the display on your instrument and the illustrated display in this manual may differ depending on the region in which your instrument was purchased and the selected display language.

■ LANGUAGE SELECT

Use the buttons below the display to select the language in which the messages are displayed.

- The **HELP** display messages and error messages are shown in the selected language.

Part I Sounds and effects

Play Style



In addition to a standard piano performance, this instrument can be used to play various different performance styles. The type of keyboard is centrally controlled by the **PLAY STYLE** section.

Normal Play

■ PIANO MODE

When this button is on, this instrument can be played as a standard piano. (Refer to page 28.)

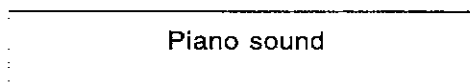
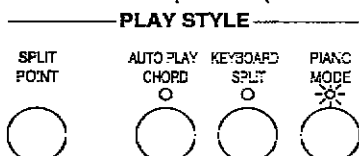

- If sounds other than piano-type sounds have been chosen, the **PLAY STYLE** indicators all go out.

■ KEYBOARD SPLIT

The keyboard divides into two playing areas, each with a different sound. (Refer to page 32.)

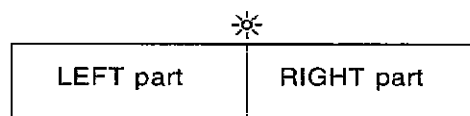
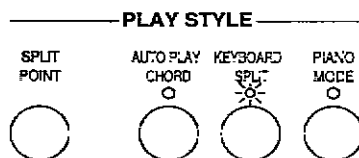

AUTO PLAY CHORD

This button is used when you perform with the automatic accompaniment. (Refer to page 43.)

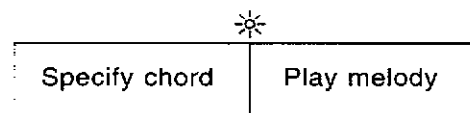
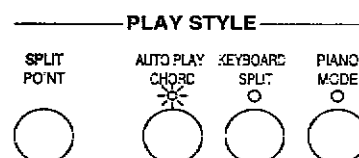

Conductor



Two parts, **RIGHT 1** and **RIGHT 2**, are usually used to select the sounds you play on the keyboard. By using the **RIGHT 1** and **RIGHT 2** buttons in the **CONDUCTOR** section, you can quickly change the sound during your performance, or you can even mix two different sounds on the keyboard (page 32).

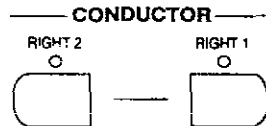

Selecting sounds

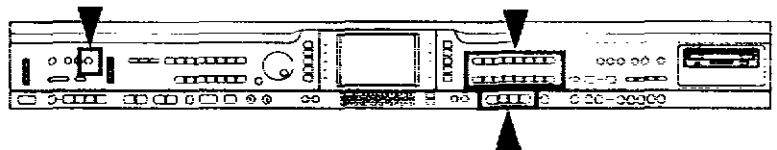

Enjoy trying the sounds of many different instruments.

PIANO MODE

When playing this instrument as a standard piano, press the **PIANO MODE** button to turn it on.



You can then select one of the piano-type sounds: **GRAND**, **UPRIGHT**, **ELECTRIC**, **MODERN**. Press the button for the desired sound.

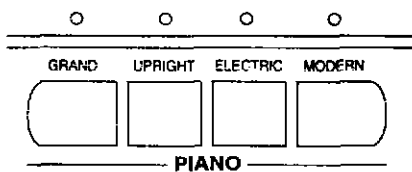

- When the piano is first turned on (initialized mode), the **PIANO MODE** is on and the default sound is **GRAND PIANO**.
- The **RIGHT 1** part is selected.
- When this button is pressed, the entire keyboard will return instantaneously to the **PIANO MODE**, regardless of the mode which is currently selected, the **KEYBOARD SPLIT** status (refer to page 32) or the **AUTO PLAY CHORD** status (refer to page 43). The sound will be set to the piano-type sound which was selected last.
- Selecting a sound other than one of the four **PIANO** sounds will cause the **PIANO MODE** to turn off automatically.

SOUND GROUP

You can select various sounds for the two parts, **RIGHT 1** and **RIGHT 2**.

1. In the **CONDUCTOR** section, choose **RIGHT 1** or **RIGHT 2**.

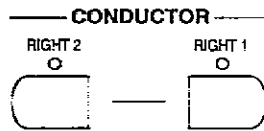

2. In the **SOUND GROUP** section, select a sound group.

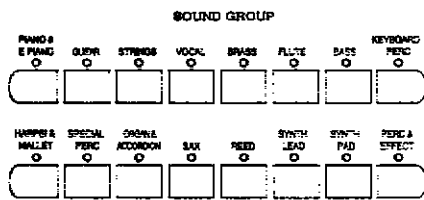

(PR900)

- A list of sounds available for each sound group can be found in the separate REFERENCE GUIDE provided.
 - Most of the sounds in the **KEYBOARD PERC** and **PERC & EFFECT** sound groups do not have scaled pitches.
3. Select the desired sound from the list on the display.

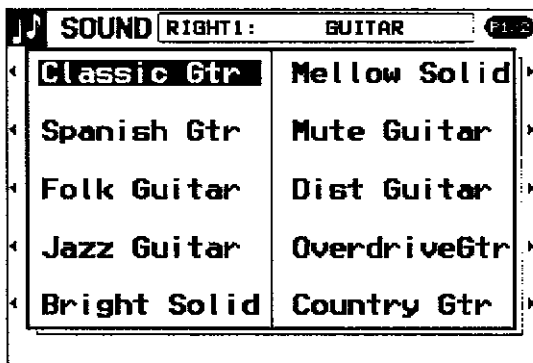

- You can use the **PAGE** buttons to view a different part of the list.
- The display returns to the previous display after a few seconds.
- The selected sound is memorized independently for each sound group, so that whenever a **SOUND GROUP** button is pressed, the sound you chose is automatically available.

4. Repeat steps 1 to 3 for the other part.
 - The **RIGHT 1** and **RIGHT 2** parts can be mixed. (Refer to page 32.)

■ Percussion sounds

You can create a percussion performance on your keyboard.

1. In the **SOUND GROUP** section, press the **KEYBOARD PERC** button.
2. Select the Kit of percussion instrument from the list on the display.
3. Play the keyboard.
 - Percussion instrument sounds are produced by the keyboard keys as indicated by the picture code above each key. (For further explanation, refer to the separate REFERENCE GUIDE provided.)
 - In the Orch Kit, the arrangement of percussion instruments is different.

Digital Drawbar (PR900)



With the **DIGITAL DRAWBAR**, you can play organ sounds.

1. In the **CONDUCTOR** section, select a part.
2. Press the **DIGITAL DRAWBAR** button to turn it on.

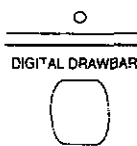

- The display looks similar to the following.

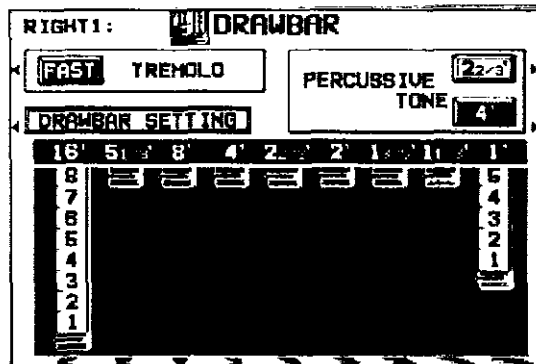

3. Use the balance buttons below the display to adjust the volume of each drawbar.
 - The drawbars are, in order from left to right, 16', 5 1/3', 8', 4', 2 2/3', 2', 1 3/5', 1 1/3', 1'. The volume of each drawbar is illustrated on the display and changes when you press the corresponding balance buttons to adjust the volume. The 1' setting is adjusted with the **PAGE** buttons.
 - The **DIGITAL DRAWBAR** can be selected only for the **RIGHT 1**, **RIGHT 2** and **LEFT** parts. (For the **LEFT** part, refer to page 32.) It can not be selected for other parts, such as, the **ACCOMP 1, 2, 3** and **BASS** parts of the **COMPOSER**, or **PART 4** to 16 of the **SEQUENCER**.

■ PERCUSSIVE TONE

PERCUSSIVE TONE adds a tone with a fast initial attack to the drawbar sounds. You can select two pitch levels of attack tones (2 2/3' and 4').

Use the **PERCUSSIVE TONE 2 2/3'** and **4'** buttons to turn the respective tone on or off.

- The tone is on when the respective indication is highlighted.

■ TREMOLO

Tremolo is a rapid oscillation in volume, like the effect of a rotating speaker. The tremolo speed can be changed while you are playing.

- The **ROTARY SPEAKER** of the **DSP EFFECT** is used for the tremolo effect. (Refer to page 36.)

Use the **TREMOLO** button to switch between the **SLOW** and **FAST** rotating speeds.

- This effect does not work if the **DSP EFFECT** button is turned off.
- The **TREMOLO** setting is effective for the **RIGHT 1**, **RIGHT 2** and **LEFT** parts in common.

■ DRAWBAR SETTING

The drawbar sounds can be adjusted more precisely.

1. Press the DRAWBAR SETTING button to highlight it.
 - The display looks similar to the following.

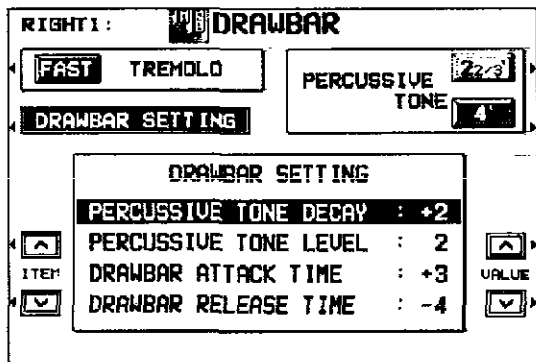

3. When you have finished changing the settings, press the DRAWBAR SETTING button again.

- The DRAWBAR SETTING is effective for the RIGHT 1, RIGHT 2 and LEFT parts in common.
- Your modified DRAWBAR sound can be stored in the PANEL MEMORY. (Refer to page 51.)

2. Select the drawbar setting you wish to change.
 - Use the ITEM ^ and v buttons to select the item. Use the VALUE ^ and v buttons to change the setting.

PERCUSSIVE TONE DECAY: Adjust the time it takes for the percussive tone to die out.

PERCUSSIVE TONE LEVEL: Adjust the volume of the percussive tone.

DRAWBAR ATTACK TIME: Adjust the time it takes for the drawbar sound to sound after a key is played.

DRAWBAR RELEASE TIME: Adjust the time it takes for the drawbar sound to die out after the keys are released.

About foot marks

The foot indication for each DRAWBAR on the display (for example 8') refers to the pitch of a rank of pipes in a pipe organ. If 8' is used as the standard (the pitch as played on the keyboard), a 16' rank pitch will be one octave below the 8' rank pitch, and a 4' rank pitch one octave above.

When the C³ key is pressed, the sounds of the different pitch ranks are as follows.

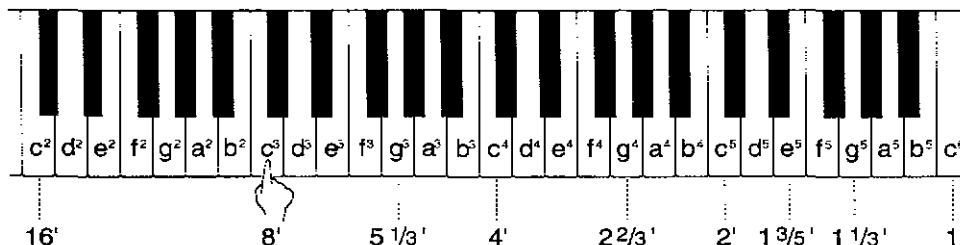

Mixing two sounds

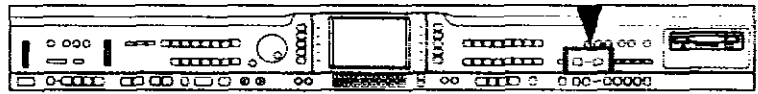

The sounds selected for the **RIGHT 1** and **RIGHT 2** parts can be mixed and played together on the keyboard.

1. Select the sounds for the **RIGHT 1** and **RIGHT 2** parts.
2. In the **CONDUCTOR** section, press the **RIGHT 1** and **RIGHT 2** buttons at the same time.

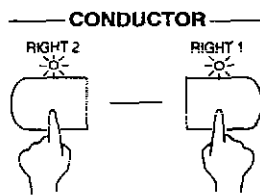

- When you play the keyboard, you hear both the **RIGHT 1** part sound and the **RIGHT 2** part sound.
- The volume balance of the **RIGHT 1** and **RIGHT 2** parts can be adjusted. (Refer to page 22.)
- Your mixed sound can be stored in the **PANEL MEMORY**. (Refer to page 51.)

Keyboard split

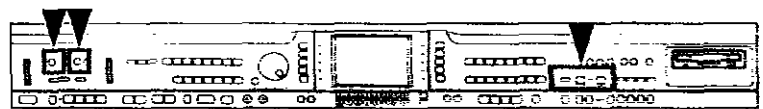

The keyboard can be divided into left and right playing sections, and a different sound played in each section.

1. Select a sound for the right part of the keyboard, and set the effects to on or off.
 - You can also turn on the **RIGHT 1** and **RIGHT 2** buttons in the **CONDUCTOR** to mix two sounds.
2. In the **PLAY STYLE** section, press the **KEYBOARD SPLIT** button to turn it on.

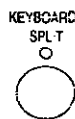

3. Press the **LEFT SELECT** button to turn it on, and select the sounds and effects for the left part.

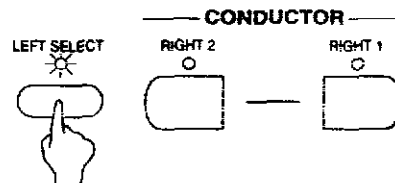

- A few seconds after you make your selection, the **LEFT SELECT** button turns off.
- You can now play different sounds for the left and right keyboard sections.

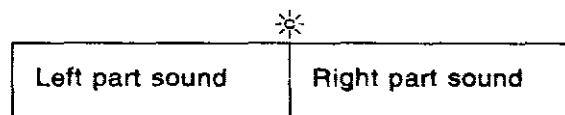

- To mute the **LEFT** part, press both the corresponding **^** and **v** buttons below the display at the same time. In this case, the left section of a split keyboard does not produce any sound.
- Press either of the **LEFT ^** and **v** buttons to cancel the mute.

SPLIT POINT

When the keyboard is divided into left and right sections, the split point is indicated by the lit indicator.

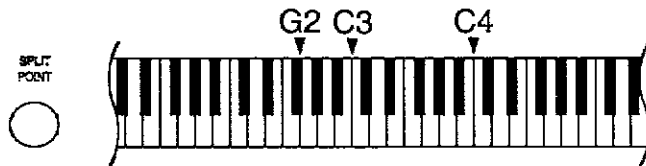

- Each time the **SPLIT POINT** button is pressed, the indication moves to the next split point in the following order: G2 → C3 → C4.

■ Customized split point

You can set the split point at a location other than G2, C3 or C4.

1. Press and hold the **SPLIT POINT** button for a few seconds.
- The following display appears.

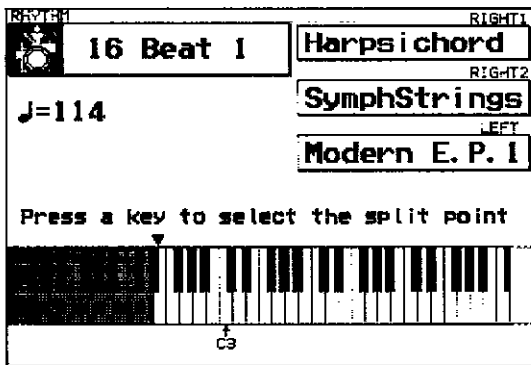

2. Press a key on the keyboard to specify the desired split point.
 - The pressed key is indicated on the display, and a split point is set at the location of the pressed key, which is the lowest note of the right keyboard section.
 - The display returns to the previous display after a few seconds.

- You can select your customized split point by pressing the **SPLIT POINT** button until none of the split point indicators is lit. In this case, the customized split point is indicated on the normal performance display.



Pedals

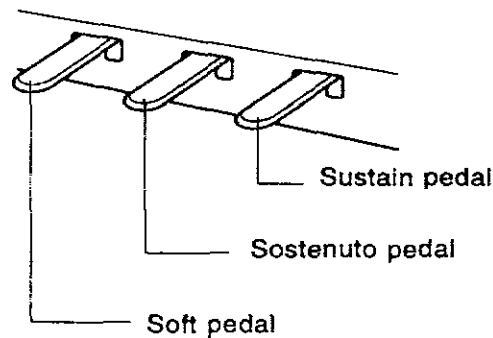

■ Sustain pedal

When a key is released while this pedal is depressed, the sound is sustained so that it lingers and slowly fades out.

- For the **GRAND PIANO** and **UPRIGHT PIANO** sounds, you will always hear a small amount of sustain on the top 17 keys, just like an acoustic piano.
- If the **SUSTAIN PEDAL** button is off, the sustain effect does not work.

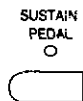

- The sustain on/off status can be set for each part independently. Select a part in the **CONDUCTOR** section and turn the **SUSTAIN PEDAL** button on or off for the part. Repeat for the other part. To select the **LEFT** part (page 32), turn on the **LEFT SELECT** button.
- This pedal is an eight-stage pedal, and the length of the sustain is controlled by the degree to which the pedal is depressed.

■ Sostenuto pedal

If this pedal is pressed while the keys are pressed, the sustain effect is applied to those notes only. If the pedal is pressed first and the keys are then pressed, the sustain effect does not work for those notes.

- For continuous-type sounds, such as **ORGAN**, the notes sound as long as the pedal is pressed.
- You can select a different function to control with this pedal. (Refer to page 53.)

■ Soft pedal

When this pedal is depressed, the sound is softer and the volume is slightly lower.

- You can select a different function to control with this pedal. (Refer to page 53.)

String resonance

String resonance is the sound heard in an acoustic piano when the struck strings produce a sympathetic resonance of the other unstruck strings. For the **GRAND PIANO** and **UPRIGHT PIANO** sounds, string resonance is produced as long as the sustain pedal is depressed. The amount of string resonance can be adjusted.

1. Press and hold the **GRAND** button for about 3 seconds.

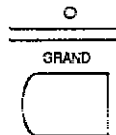

- The indicator flashes slowly, and **STRING RESONANCE DEPTH** is shown on the display.
2. Use the \wedge and \vee buttons to adjust the amount of resonance (0 to 99).

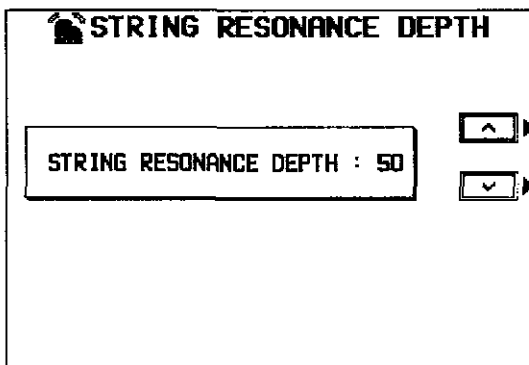

- The higher the number, the greater the amount of resonance.
- When set to 0, there is no string resonance.

3. When you have finished adjusting the string resonance, press the **GRAND** button again.
 - This effect does not work when the **DIGITAL REVERB** is on.



Effects



You can achieve even fuller and stirring sounds by adding various effects.

DIGITAL EFFECT

DIGITAL EFFECT gives the sound richness and enhances your performance.

1. Select a part to which this effect will be applied; turn on the **RIGHT 1** or **RIGHT 2** button in the **CONDUCTOR** section, or the **LEFT SELECT** button.
2. Press the **DIGITAL EFFECT** button to turn it on for the selected part.

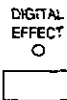

- The **DIGITAL EFFECT** on or off status is preset for each sound, so that the **DIGITAL EFFECT** automatically turns on when certain sounds are selected.
- This effect differs depending on the selected sound.
- This effect does not work for the **DIGITAL DRAWBAR** sounds (**PR900**) and the **KEYBOARD PERC** sounds.
- The display can also be used to set this effect to on or off for each part. (Refer to page 112.)

DSP EFFECT

You can change the quality of the sound.

1. Select a part to which this effect will be applied; turn on the **RIGHT 1** or **RIGHT 2** button in the **CONDUCTOR** section, or the **LEFT SELECT** button.
2. Press the **DSP EFFECT** button to turn it on for the selected part.

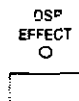

- The **DSP EFFECT** can be set to on or off for each part.
- **PR900**: When the **DIGITAL DRAWBAR** is on, this button turns on the tremolo (**ROTARY SPEAKER**) effect. The **DSP EFFECT** is turned off for all parts except those for which the **DIGITAL DRAWBAR** is selected.
- If you press and hold this button, the display can be used to select the type of **DSP EFFECT** and to make fine adjustments. (Refer to page 117.)

BRILLIANCE

Change the brightness of the sound.

1. Select a part to which this effect will be applied; turn on the **RIGHT 1** or **RIGHT 2** button in the **CONDUCTOR** section, or the **LEFT SELECT** button.
2. Press the **BRILLIANCE** button for the selected part.



3. Use the buttons to the left of the display to select the type of brilliance.
 - Select from **BRIGHT**, **NORMAL**, **WARM** and **MELLOW**.
 - You can use the **PART** \wedge and \vee buttons to select other parts.
 - For some sounds, the **BRILLIANCE** does not change.
 - The display returns to the previous display after a few seconds.

- The following display appears.

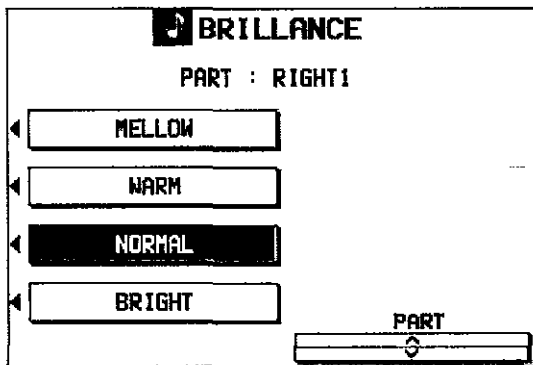

DIGITAL REVERB

DIGITAL REVERB applies a reverberation effect to the sound.

Press the **DIGITAL REVERB** button to turn it on.



- This effect is applied to all the sounds of this instrument.
- If you press and hold this button, the display can also be used to select the type of **DIGITAL REVERB** and to make related fine adjustments. (Refer to page 117.)
- The display can also be used to set the depth of this effect for each part. (Refer to page 112.)

Transpose



The **TRANPOSE** buttons are used to change the key of the entire instrument in semitone steps across an entire octave.

Suppose you learn to play a song—in the key of C, for example—and decide you want to sing it, only to find that it's either too high or too low for your voice. Your choice is to either learn the song all over again in a different key, or to use the **TRANPOSE** feature.

Adjust the key with the < and > buttons.

<Example: transposed to D>

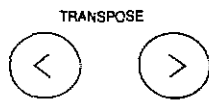

- Each press of the > button changes the key as follows: D^b → D → E^b → E → F → F[#]. Each press of the < button changes the key as follows: B → B^b → A → A^b → G.
- If the two buttons are pressed at the same time, the key returns to C.
- When the **TRANPOSE** function is active, the transposed key is shown on the display.

Played keys



C major



Notes that sound

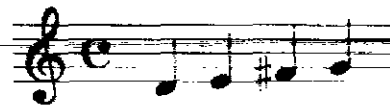

D major

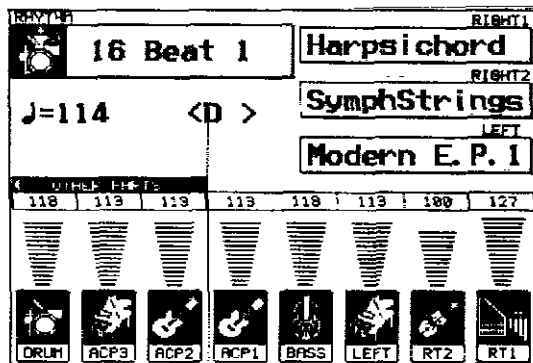

Actual key

Techni-chord



TECHNI-CHORD turns your single-note melodies into full chords and offers you a choice of 13 different types, from a simple duet which adds one harmony note to your melody note, to big band reeds which adds four harmony notes to your melody note. If **TECHNI-CHORD** is part of a **ONE TOUCH PLAY** or **MUSIC STYLE SELECT** registration, a suitable **TECHNI-CHORD** type will be selected automatically.

1. Split the keyboard into left and right sections.
(Refer to page 32.)

2. Press the **TECHNI-CHORD** button to turn it on.

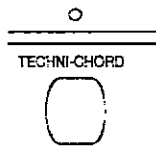

3. Play the keyboard.

- The melody you play with your right hand is automatically played in chords which are based on the chords you play with your left hand.

Example:

Left hand (chord)

Right hand (melody)

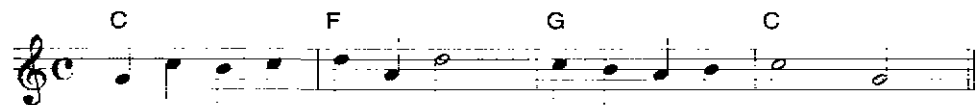

- This feature is very effective when used with the **AUTO PLAY CHORD**. (This feature does not work in the **PIANIST** mode.)
- If you press and hold this button, the display can be used to select the desired harmony style. You can also have the melody and harmony produced in different sounds. (Refer to page 115.)

Part II Playing the rhythm

The rhythm section enhances the capabilities of your instrument with features such as automatic performance of the preset rhythm patterns and accompaniment patterns.

Selecting rhythms

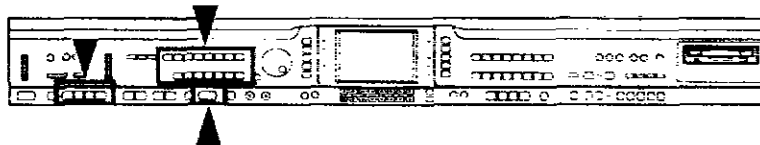

After first selecting a **RHYTHM GROUP**, choose the desired rhythm from the display.

Select a rhythm

1. In the **RHYTHM GROUP** section, select a rhythm group.

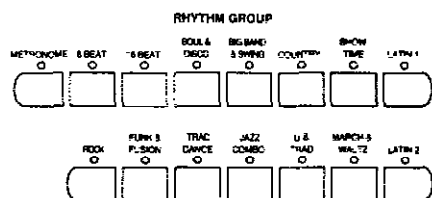

■ VARIATION

There are four variations available for each rhythm. Use the **VARIATION & MSA** buttons to select the desired variation.

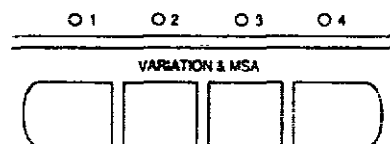

- A list of rhythms available for each rhythm group can be found in the separate **REFERENCE GUIDE** provided.
- A **COMPOSER CHORD MAP** can also be selected as a rhythm. (Refer to page 95.)

- The nuance of the pattern differs with each variation number.
- You can change to a different variation while the rhythm is playing.

2. Select the desired rhythm from the list on the display.

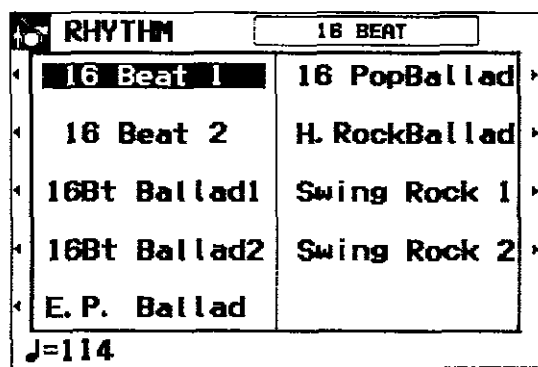

- The rhythm you selected is shown in the **RHYTHM** box on the normal performance display.
- The selected rhythm is memorized independently for each rhythm group, so that whenever a **RHYTHM GROUP** button is pressed, the rhythm you chose is automatically available.
- A few seconds after the setting is changed, the display returns to the previous display.

METRONOME

- In the **RHYTHM GROUP** section, select **METRONOME**.
 - The following display appears.

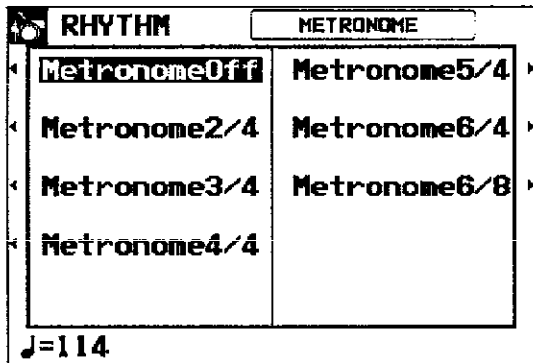

- Select the time signature for the metronome.
 - Select "Metronome Off" if you do not wish the first beat of the measure to be accented.
 - Press the **START/STOP** button to start the metronome.

Start the rhythm

There are two ways to start the rhythm.

■ Immediate rhythm start

- Select a rhythm.
- Press the **START/STOP** button to turn it on.



- The selected rhythm pattern immediately begins to play.
- You can stop the rhythm by pressing the **START/STOP** button again to turn it off.
- The **BEAT** indicators above the **START/STOP** button light to indicate the beat. On the first beat of the measure, the red indicator lights. On the second and succeeding beats of the measure, the green indicators light in order.

■ Synchronized start

With the synchronized start feature, the rhythm pattern starts when you play a key on the keyboard.

- Select a rhythm.
- Press the **SYNCHRO START** button to turn it on.

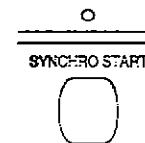

- Play a key to the left of the keyboard split point.

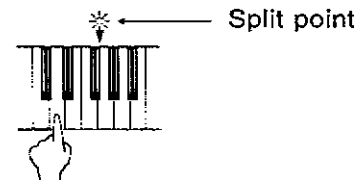

- The rhythm pattern begins to play.
- You can use the synchronized start feature even when the keyboard is not divided into left and right sections. To start the rhythm, press a key to the left of the specified split point.

■ **Adjust the tempo**

The tempo of the rhythm pattern is adjusted with the **TEMPO/PROGRAM** dial.

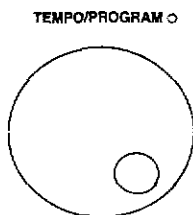

- The tempo is shown on the display as a numerical value (♩ = 40 to 300).
- When the **TEMPO/PROGRAM** indicator is lit, the **TEMPO/PROGRAM** dial cannot be used to adjust the tempo.

■ **TAP TEMPO**

You can set the tempo of the rhythm by tapping this button few times with your finger.



- The tempo at which the button is tapped is detected, and the tempo automatically changes correspondingly.

Playing the rhythm



Intro, fill-in and ending patterns fitting each different rhythm pattern are permanently recorded in your instrument, thus allowing a versatile rhythm performance.

INTRO

Begin the rhythm performance with an intro pattern.

1. Press the **INTRO & ENDING 1** or **INTRO & ENDING 2** button to turn it on.
2. Press the **START/STOP** button to start the rhythm.

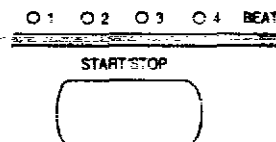
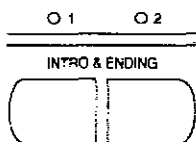

- An intro pattern is played, after which the normal rhythm pattern begins.

COUNT INTRO

You can begin the rhythm performance with a one-measure count.

1. Press the **COUNT INTRO (FILL IN 2)** button to turn it on.
 2. Press the **START/STOP** button to start the rhythm.
- A one-measure count is played, after which the normal rhythm pattern begins.

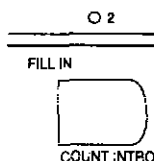

FILL IN

You can insert a fill-in pattern any time during the rhythm performance. Choose from two different fill-in patterns.

1. Select a rhythm and press the **START/STOP** button.
2. Press the **FILL IN 1** or **FILL IN 2** button.

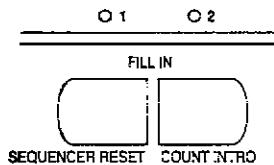

- A fill-in pattern is heard immediately for the remainder of the measure.
- When a **FILL IN** button is pressed on the last beat of the measure, the fill-in pattern continues to the end of the following measure.

ENDING

Finish the rhythm performance with an ending pattern.

1. Select a rhythm and press the **START/STOP** button.
2. Press the **INTRO & ENDING 1** or **INTRO & ENDING 2** button to turn it on.

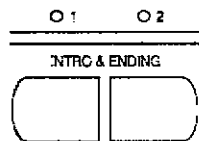

- An ending pattern is produced, and then the rhythm performance stops.
- If you accidentally press an **INTRO & ENDING** button in the middle of the tune, you can press the **FILL IN 1** or **FILL IN 2** button. The ending pattern stops, and a fill-in pattern is produced, after which the normal rhythm performance continues.

Auto Play Chord



Simply by playing a chord on the keyboard, the **AUTO PLAY CHORD** function automatically plays an accompaniment pattern which matches perfectly the selected rhythm. With a real accompaniment as a background, you can concentrate on playing the melody.

How the AUTO PLAY CHORD works

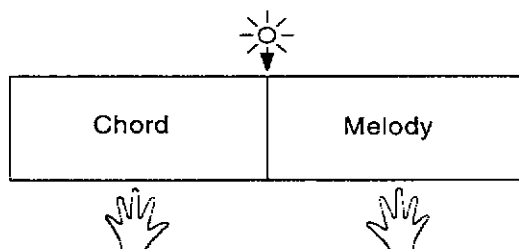

When an **AUTO PLAY CHORD** mode is selected, an automatic accompaniment which matches the rhythm you have chosen is played in the chord which you specify with your left hand. The melody is played with your right hand.

- The accompaniment pattern of the **AUTO PLAY CHORD** is composed of five parts: **DRUMS, BASS, ACCOMP 1, ACCOMP 2** and **ACCOMP 3**.

How to play chords

There are four different ways to specify chords on the keyboard.

■ BASIC mode

For beginning players, a left-hand chord can be specified with just one finger. You can either press one key on the left keyboard section to specify the root note (one-finger), or play all the notes of the chord (fingered).

- The sound selected for the left section of the keyboard is muted. If you cancel the mute for the left keyboard while in this mode, the left-part sound can then be heard, but the one-finger chord function will not work.
- When the rhythm is on, even if the keys are released, the accompaniment continues to play in the specified chord until you specify another chord.

<One-finger>

Press a key in the left keyboard section to specify the root note. The major chord corresponding to this root note is automatically played in an accompaniment pattern.

Example: C chord

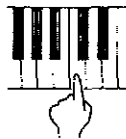

Minor, seventh and minor seventh chords are also easily produced.

Minor chord	Seventh chord	Minor seventh chord
Play the root note plus a black key to the left of it.	Play the root note plus a white key to the left of it.	Play the root note plus a black key and a white key to the left of it.
Example: Cm 	Example: C7 	Example: Cm7

<Fingered>

Specify the chord by playing all the notes in the chord. When you play chords this way, the **AUTO PLAY CHORD** recognizes more chord types, and thus the scope of your performance expression is expanded.

- Play chords by pressing at least three keys.
- The **AUTO PLAY CHORD** can distinguish the following played chords for each key (C is given as an example): C, C7, CM7, Caug, Caug7, Cm, Cm7, Cdim, Cm7^{b5}, CmM7, Csus4, C7sus4, C^{b5}, C7^{b5}, Cm^{b5}, C6, Cm6, CM7^{b5}, CM7^{b5}, CmM7^{b5}, etc.



■ ADVANCED 1 mode

In this mode, the chord is specified by playing it (fingered) on the left part of the keyboard. Chords which the **AUTO PLAY CHORD** does not recognize are ignored.

- The keyboard automatically divides into left and right playing sections.
- The sound selected for the left section of the keyboard is produced, but you can mute this part. (Refer to page 22.)
- Play chords by pressing at least three keys.
- In this mode, the piano can also recognize chords such as 9th and 13th chords.
- When the rhythm is on, even if the keys are released, the accompaniment continues to play in the specified chord until you specify another chord.

■ ADVANCED 2 mode

Chords are specified in the same manner as for the **ADVANCED 1 mode**. However, if the **AUTO PLAY CHORD** does not recognize the chord, the automatic accompaniment is based on the pitches of the pressed keys.

■ PIANIST mode

In the **PIANIST mode**, the entire keyboard can be used to specify chords for the automatic accompaniment. This mode is used to add an automatic accompaniment to the performance on a standard piano.

- The keyboard does not split.
- Chords can be specified (fingered) anywhere on the keyboard.
- Play chords by pressing at least three keys.
- In this mode, the piano can also recognize chords such as 9th and 13th chords.
- When the rhythm is on, even if the keys are released, the accompaniment continues to play in the specified chord until you specify another chord.

<ON BASS>

The **BASS** part is produced in the key of the lowest note of the played chord (except for One-finger). When this button is on, it is possible to specify chords such as "C on G" with just one hand.

- For example, with the **ON BASS** button on, if you play a C chord by pressing the keys G, C and E, the bass part is produced in the key of G.

<APC HOLD>

During a performance in the **PIANIST mode**, for example, if you press the pedal to which the **APC HOLD** function is assigned, the currently specified chord is maintained, allowing you to focus your performance on a solo melody.

- The accompaniment continues in the same chord as long as the pedal is depressed, and it does not change even if other chords are played.
- To change the pedal assignment, refer to page 53.

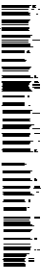

How to use the AUTO PLAY CHORD

1. Select the desired rhythm and sound(s), and set the tempo.
2. Press the **AUTO PLAY CHORD** button to turn it on.

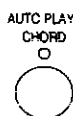

- The display looks similar to the following.

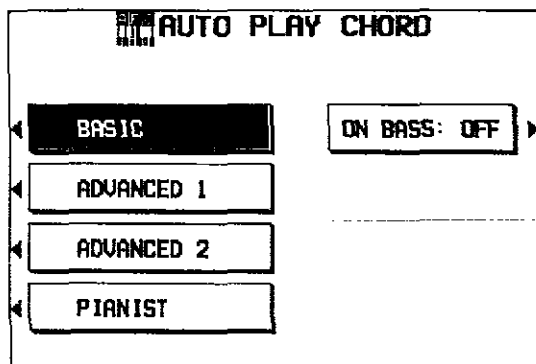

3. Use the buttons to the left of the display to select the **AUTO PLAY CHORD** mode.
 - You can also select the **ON BASS** status at this time.
 - After a few seconds, the display returns to the previous display.
4. Press the **START/STOP** button to begin the rhythm.
 - You can also start the rhythm by playing a key on the keyboard. (Refer to page 41.)

5. Specify a chord.
 - If the **BASIC**, **ADVANCED 1** or **ADVANCED 2** mode was selected, specify the chord on the keyboard section to the left of the split point.

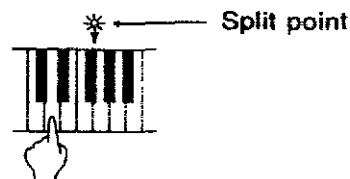

- An accompaniment pattern in the specified chord is automatically played.
- When you use **FILL IN**, **INTRO** and **ENDING**, the automatic accompaniment is also used in these patterns.
- You can set the mode which determines how the **LEFT** part sounds during an **AUTO PLAY CHORD** performance. (Refer to page 116.)
- If the **AUTO PLAY CHORD** button is pressed during an automatic accompaniment, the button does not turn off, and the display changes to the mode-setting display.

6. To stop the automatic accompaniment, press the **START/STOP** button.
 - When the rhythm is off, if the **BASIC**, **ADVANCED 1** or **ADVANCED 2** mode is on and a chord is specified, the specified root note (**R. BASS** part) and chord notes (**CHORD** part) are produced. The volumes of these notes can be adjusted. (Refer to page 108.)

AUTO PLAY CHORD part volume balance

The volume of all the parts comprising the **AUTO PLAY CHORD** (**DRUMS**, **ACCOMP 1**, **2**, **3**, **BASS**) can be adjusted with the sliding **RHYTHM VOLUME** control.



- At the **MAX** setting, the volume is at its loudest. At the **OFF** setting, the automatic accompaniment parts do not sound.
- You can also adjust the volume of each part. (Refer to page 22.)
- When the actual volume level corresponds correctly to the position of the sliding controller, the indicator is lit. However, when the actual volume level and the controller position differ, the indicator is not lit, for example when a **PANEL MEMORY** has been recalled to change the panel settings (page 51).

Piano Stylist



For performances using piano sounds, just select a piano style, and your panel registration, such as the sounds and effects, is set in seconds.

1. Press the **PIANO STYLIST** button to turn it on.

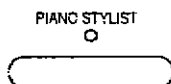

- The following display appears.

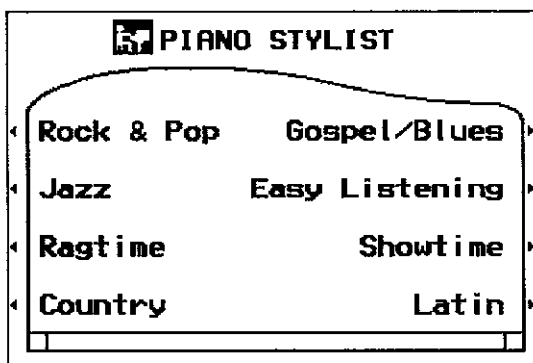

2. Select a **STYLE** group from the display.
- The following display appears.

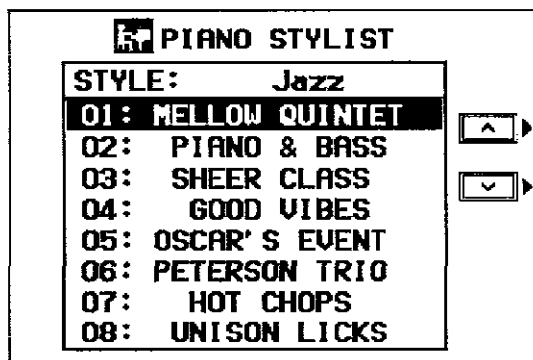

- The name of the style shown on the display may become altered.

3. Use the \wedge and \vee buttons to select the performance style.

- The **AUTO PLAY CHORD** (BASIC mode), an **INTRO & ENDING** button and the **SYNCHRO START** button turn on, and the rhythm, effects and tempo which are best suited for the selected style are automatically selected. When you press a key on the left section of the keyboard, an intro is played, after which the automatic rhythm is played. Play the melody with your right hand.
- The octave and stereo balance of the sound may change.
- The left (soft) pedal function changes to APC HOLD. (Refer to page 53.)
- To return the functions of this instrument to their original settings, perform the INITIAL procedure. (Refer to page 127.)

Suggestions for using PIANO STYLIST

Use the **PIANO STYLIST** registration as a starting point for your own registration. Alter the sounds, balance and tempo to your own taste and store your new registration in the **PANEL MEMORY** for future use. (Refer to page 51.)

One Touch Play



ONE TOUCH PLAY sets up your instrument with a suitable registration for your chosen rhythm style so that you can make a great sound straight away, even if you are playing this instrument for the first time. Using **ONE TOUCH PLAY** sets a suggested combination of sounds and balances and an appropriate tempo for the rhythm style at the push of a button.

1. Select an **AUTO PLAY CHORD** mode. (Refer to page 44.)
2. Select a rhythm pattern.
 - Do not select a **COMPOSER CHORD MAP** or a rhythm from a **COMPOSER MEMORY**.
3. Press the **ONE TOUCH PLAY** button until its indicator goes out.



- The display looks similar to the following.

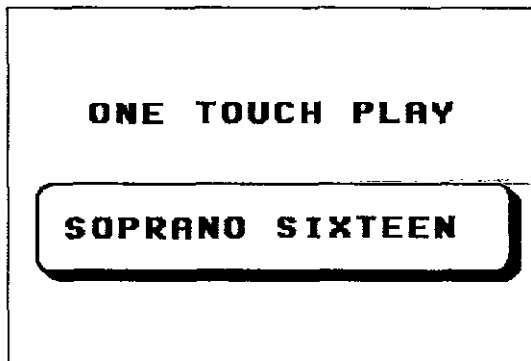

Suggestions for using **ONE TOUCH PLAY**

Press the **INTRO & ENDING** button before you play for a professional sounding introduction. Use the **ONE TOUCH PLAY** registration as a starting point for your own registration. Alter the sounds, balance and tempo to your own taste and store your new registration in the **PANEL MEMORY** for future use. (Refer to page 51.)

- The **AUTO PLAY CHORD** button and the **SYNCHRO START** button are automatically turned on. When a key on the left section of the keyboard is pressed, the automatic rhythm begins to play immediately.
- If an **AUTO PLAY CHORD** mode was not selected in step 1, the **BASIC** mode becomes active.
- The octave and stereo balance of the sound may change.
- The function of the left (soft) pedal is automatically set (**SOFT PEDAL**, **GLIDE**, etc.).
- To return the functions of this instrument to their original settings, perform the **INITIAL** procedure. (Refer to page 127.)

Music Style Select



MUSIC STYLE SELECT sets up your instrument with a suitable registration for a specific style of music. Select from this instrument's list of style names and **MUSIC STYLE SELECT** does the rest for you, setting suitable sounds and volume balances, along with the appropriate rhythm, accompaniment and tempo for your chosen style.

1. Select an **AUTO PLAY CHORD** mode. (Refer to page 44.)

2. Press the **MUSIC STYLE SELECT (ONE TOUCH PLAY)** button momentarily.

- The display looks similar to the following.

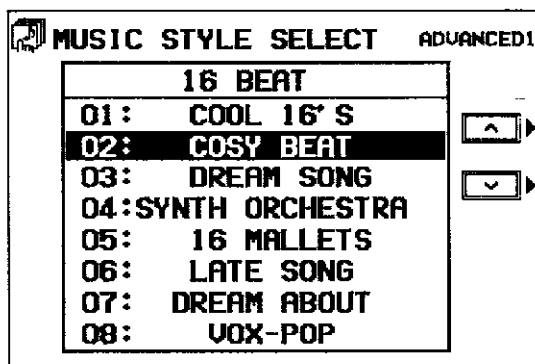

- The name of the style shown on the display may become altered.

3. In the **RHYTHM GROUP** section, select a rhythm group.

4. Use the \wedge and \vee buttons to select a music style.

- The **AUTO PLAY CHORD** button and the **SYNCHRO START** button turn on, and the sounds, effects, rhythm and tempo which are best suited for the selected music style are automatically selected. When a key on the left section of the keyboard is pressed, the automatic rhythm begins to play immediately.
- If an **AUTO PLAY CHORD** mode was not selected in step 1, the **BASIC** mode becomes active.
- The octave and stereo balance of the sound may change.
- The function of the left (soft) pedal is automatically set (**SOFT PEDAL**, **GLIDE**, etc.)

- To return the functions of this instrument to their original settings, perform the **INITIAL** procedure. (Refer to page 127.)

Suggestions for using MUSIC STYLE SELECT

Press the **INTRO & ENDING** button before you play for a professional sounding introduction. Use the **MUSIC STYLE SELECT** registration as a starting point for your own registration. Alter the sounds, volume balance and tempo to your own taste and store your new registration in the **PANEL MEMORY** for future use. (Refer to page 51.)

Music Style Arranger

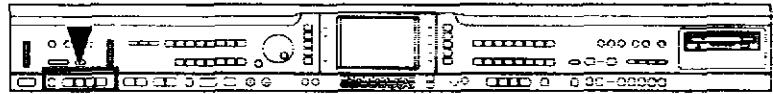

The **MUSIC STYLE ARRANGER** helps you to make professional registration changes during your performance. Select between four contrasting registrations at the push of a button, or let your instrument change the registration automatically for you when you use **FILL IN 1** or **2**. The **MUSIC STYLE ARRANGER** will also alter the accompaniment in character with the registration change, creating a polished sounding arrangement.

How to use the MUSIC STYLE ARRANGER

1. Select a rhythm pattern.
 - When the **PIANIST** mode of the **AUTO PLAY CHORD** is selected, the **MUSIC STYLE ARRANGER** does not work.
2. Press the **MUSIC STYLE ARRANGER** button to turn it on.



3. Use the **VARIATION & MSA** buttons to select a style (1 to 4).

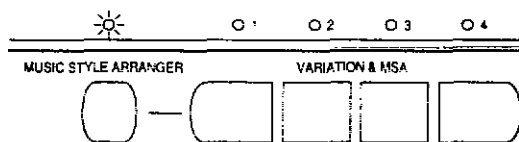

- The nuance of the pattern differs with each number.
- The panel settings (including the tempo) change according to the selected rhythm and music style. The **AUTO PLAY CHORD** button and the **SYNCHRO START** button are automatically turned on. When a key on the left section of the keyboard is pressed, the automatic rhythm begins to play immediately.
- The octave and stereo balance of the sound may change.
- The function of the left (soft) pedal is automatically set (**SOFT PEDAL**, **GLIDE**, etc.)
- To return the functions of this instrument to their original settings, perform the **INITIAL** procedure. (Refer to page 127.)
- During your performance, the style can be changed, but the tempo does not change.

How to change the music style during your performance

While you are playing the keyboard with the **MUSIC STYLE ARRANGER** on, press the **FILL IN 1** or **FILL IN 2** button.

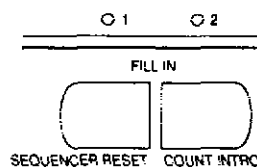

- Each time the **FILL IN 1** button is pressed, the **FILL IN 1** pattern plays, and then the music style changes in the **4 → 3 → 2 → 1** order. And each time the **FILL IN 2** button is pressed, the **FILL IN 2** pattern plays, and then the style changes in the **1 → 2 → 3 → 4** order.

■ MUSIC STYLE ARRANGER mode

You can define which panel settings change by pressing a **FILL IN** button when the **MUSIC STYLE ARRANGER** is used.

1. Press and hold the **MUSIC STYLE ARRANGER** button for a few seconds.
 - The display changes to the following.

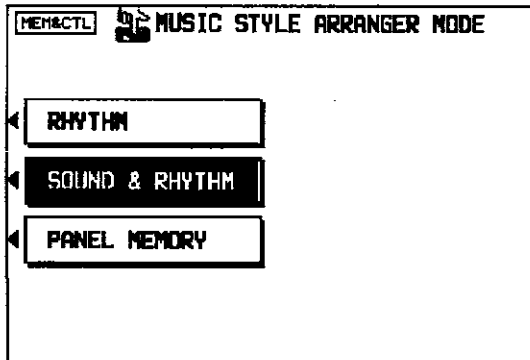

2. Select the mode.
 - RHYTHM**: Only the rhythm changes.
 - SOUND & RHYTHM**: Both the sound and rhythm change.
 - PANEL MEMORY**: The **PANEL MEMORY** number (**BANK A**: 1 to 4) changes.
 - After a few seconds, the display exits the setting mode.
 - You can also access this setting display from the **MEMORY & CONTROL** menu display. (Refer to page 98.)

Panel Memory



PANEL MEMORY stores the panel set up of this instrument allowing you to make complex changes at the push of a single button.

How to store the panel settings

1. Set up the desired panel settings (sounds, volumes, etc.).
2. Press the **BANK** buttons to select a bank (**A** or **B**).
3. With the **SET** button held down, press one of the numbered buttons of the **PANEL MEMORY** (1 to 5).

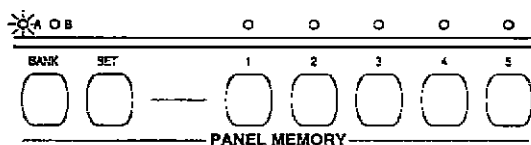

- To recall the stored settings, just select the **BANK** and press the desired **PANEL MEMORY** number button. (You can then change the sound settings, etc. manually; however, the memory contents of the **PANEL MEMORY** remain unchanged until you store them again.)
 - The **PANEL MEMORY** settings can be saved on a disk for recall at a later time. (Refer to page 103.)
- The panel settings are now stored in the specified bank and number.

■ PANEL MEMORY mode

You can define which panel settings are stored when the **PANEL MEMORY** is used.

1. Press and hold the **SET** button for a few seconds.
- The display changes to the following.

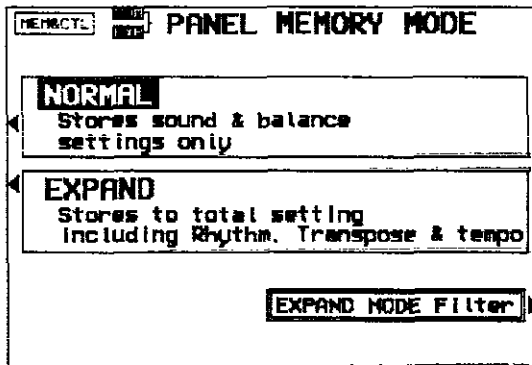

■ EXPAND MODE FILTER

You can specify which data is stored in the **EXPAND** mode.

1. On the **PANEL MEMORY MODE** display, press the **EXPAND MODE FILTER** button.
- The display looks similar to the following.

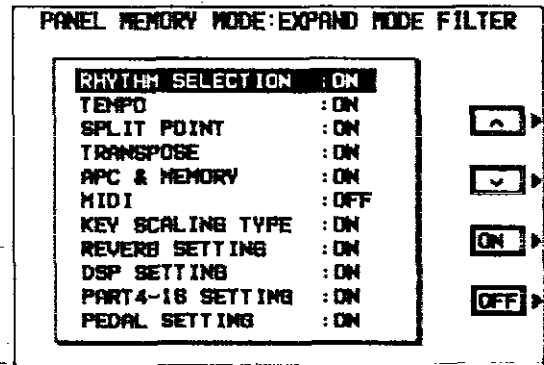

2. Select the mode.

NORMAL: The sounds and volume balance, effects and **CONDUCTOR** status are stored.

EXPAND: All the instrument's settings are stored, including the rhythm, **TRANSPOSE**, tempo, etc.

- After a few seconds, the display exits the setting mode.
- You can also access this setting display from the **MEMORY & CONTROL** menu display. (Refer to page 98.)

2. Use the **^** and **v** buttons to select the item.

3. Use the **ON** and **OFF** buttons to store the on or off status for the selected item.

4. Repeat steps 2 and 3 for each item, as desired.

Suggestions for using **PANEL MEMORY**

The initial factory setting of **PANEL MEMORY** contains professional settings which you may choose to use or to alter to your own taste. These can be restored at any time by initializing the **PANEL MEMORY**. You can change from one **PANEL MEMORY** to another by pressing the soft pedal or the sostenuto pedal. Press **MEMORY & CONTROL** and select **PEDAL SETTING** on the display to assign this function.

Pedal setting

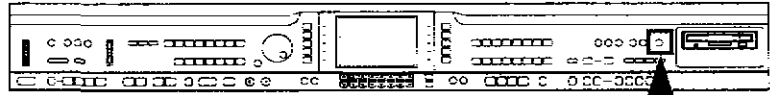

You can assign a different function to the soft pedal and to the sostenuto pedal. The assigned function can then be controlled by pressing the pedal.

- The sustain pedal function cannot be changed.

Assigning functions

1. Press the **MEMORY & CONTROL** button to turn it on.

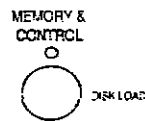

- The display changes to the following.

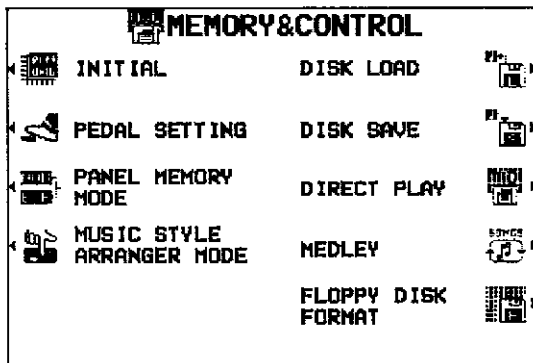

2. Select **PEDAL SETTING**.

- The display changes to the following.

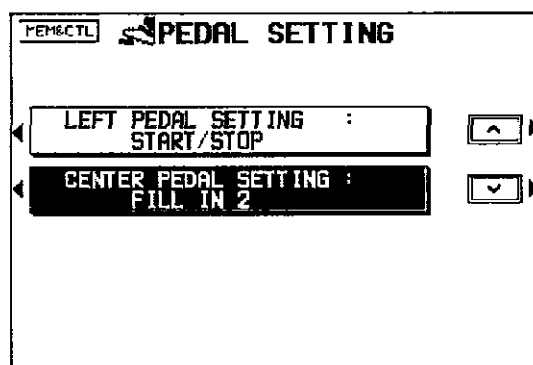

3. Select **LEFT PEDAL SETTING** (soft pedal) or **CENTER PEDAL SETTING** (sostenuto pedal).

4. Use the \wedge and \vee buttons to select a desired function.

SOFT PEDAL: soft pedal on/off (Refer to page 34.)
SOSTENUTO PEDAL: sostenuto pedal on/off (Refer to page 34.)
START/STOP: **START/STOP** button on/off
FILL IN 1: **FILL IN 1** button on
FILL IN 2: **FILL IN 2** button on
INTRO & ENDING 1: **INTRO & ENDING 1** button on
INTRO & ENDING 2: **INTRO & ENDING 2** button on
GLIDE: Glide on/off (The glide effect "bends" the pitch down by about one semitone.)
SUSTAIN: **SUSTAIN PEDAL** button on/off
TECHNI-CHORD: **TECHNI-CHORD** button on/off
DIGITAL EFFECT: **DIGITAL EFFECT** button on/off
DSP EFFECT: **DSP EFFECT** button on/off
PANEL MEMORY INC: Increment the **PANEL MEMORY** selection by 1.
PANEL MEMORY DEC: Decrement the **PANEL MEMORY** selection by 1.
PANEL MEMORY A-1 to B-5: The specified **PANEL MEMORY** bank and number are turned on.
PUNCH RECORD: Punch in/punch out (Refer to page 81.)
APC HOLD: Maintain the specified chord during an **AUTO PLAY CHORD** performance. (Refer to page 45.)
ROTARY SLOW/FAST:
TREMOLO SLOW/FAST of the **ROTARY SPEAKER** of the **DSP EFFECT**.
OFF: No function.

5. Repeat steps 3 and 4 to assign functions to the other pedal as desired.

6. When you have completed making the settings, press the **MEMORY & CONTROL** button to turn it off.

Part III Sequencer

Outline of the Sequencer

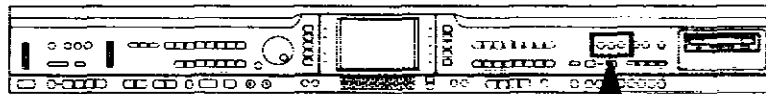

A sequencer records your performance in a similar way to a tape recorder. This instrument's **SEQUENCER** allows you to record up to 10 performances in a variety of ways. You may want to record your entire performance in one go (especially if you are using **AUTO PLAY CHORD** to provide the accompaniment), or to build up a complex arrangement with several different parts playing together, like an orchestral score. This instrument's **SEQUENCER** has 16 tracks. This means that you can record 16 different parts. However, you don't have to use all 16 tracks. For some uses you may only need to use one or two tracks. This instrument's **SEQUENCER** enables you to edit your recorded performance. Unlike a tape recorder you can change the sound or the tempo during playback, or correct wrong notes or timing errors.

SEQUENCER features

- **You can change the tempo without changing the pitch**

When you record your performance at a slow tempo and play it back at a faster tempo, the pitch stays the same.

- **Consistent sound**

Your performance is reproduced by a sound module as it reads digital data. So, unlike a recorded tape, the sound never deteriorates no matter how many times you play back your performance.

- **Edit your recorded performance**

Comprehensive editing functions allow you to modify your recorded performance. Data can easily be erased, corrected or copied, providing an especially convenient tool for creating your original tunes.

- **Instant search**

A recorded tape has to be rewound, but digital action means you can return to the beginning of your performance, or find any measure, instantly.

- **Save your performances on disks**

All the data of your recorded performances can be stored on disks. The built-in Disk Drive also allows you to play back and use commercially sold disks on your own instrument.

- Features and operation of the built-in Disk Drive are explained in Part V: Disk Drive (page 97).

Popular features

- **Simplified recording method**

EASY RECORD is a feature that allows you to bypass the more complex recording procedures so you can record and play back your performance quickly and easily.

- You can also record an accompaniment from the **AUTO PLAY CHORD**.

- **Create a one-man ensemble**

Use the **REALTIME RECORD** function to record your performance in up to 16 tracks and create your own orchestra or band.

- **Store individual data to create your song**

For repeating patterns or those especially complicated phrases, the **STEP RECORD** feature is convenient for recording the notes one-by-one.

- This method can be used to store both the chord progression for the automatic accompaniment and the rhythm changes.

Memory capacity

Up to 10 songs can be stored in the **SEQUENCER**. Expressed in terms of notes, the total number of notes which can be stored in all the **SEQUENCER** songs and tracks is about 30,000. The remaining memory available for recording is shown on the display as a percentage (**MEMORY= %**).

- When "Memory full!" appears on the display, no more data can be stored in the **SEQUENCER**.
- The recorded contents can be saved on a disk for recall at a later time. (Refer to page 103.)

About the measure count

The measure count on the display corresponds to the time signature of the selected rhythm. However, if rhythm data is stored in the **RHYTHM** part and that part is played back, the measure count on the display corresponds to the stored rhythm data. (Refer to page 67.)

- If you wish to use a time signature not available in the preset rhythms, use the **COMPOSER** to create a new time signature. (Refer to page 84.)

SEQUENCER MENU

When you press the **MENU** button in the **SEQUENCER** section to turn it on, the display changes to the following.

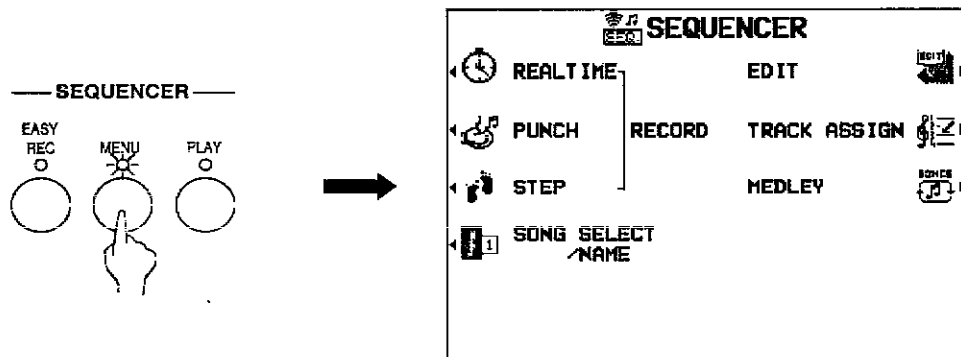

Summary of the SEQUENCER MENU Items

SONG SELECT/NAME (page 56)

Specify the song number and name of the song to record or play back.

REALTIME RECORD (page 59)

Record your performance just as you play it on the keyboard.

STEP RECORD (page 63)

Store the sounds note-by-note on the display.

TRACK ASSIGN (page 69)

Assign parts to up to 16 different tracks.

EDIT (page 70)

Full-scale editing features are available.

NOTE EDIT: Store and correct performance (NOTE) data on a piano roll display.

DRUM EDIT: Store and correct DRUMS part data on a special display.

QUANTIZE: Correct the timing of the recorded performance.

TRANSPOSE: Change the key of specified performance data.

VELOCITY CHANGE: Modify the recorded velocity (how hard the keyboard was played).

SONG CLEAR: Erase the recorded contents of a specified song.

TRACK CLEAR: Erase the contents of a specific track.

NOTE CHANGE: Change the pitch of specific notes.

ADVANCE/DELAY: Speed up or delay the sound production of performance data.

SONG COPY: Copy specific songs.

TRACK MERGE: Merge the recorded contents of two tracks and store in a third track.

PANEL WRITE: Modify the panel status at the beginning of the song.

MEASURE COPY: Copy the contents of specific measures.

MEASURE ERASE: Erase the contents of specific measures.

MEASURE DELETE: Delete specific measures from the performance.

MEASURE INSERT: Insert additional measures in the performance.

PUNCH RECORD (page 81)

Correct a selected portion of your recorded performance.

MEDLEY (page 83)

Have the songs played in a medley performance.

Song Select & Name

Up to 10 songs can be recorded in the **SEQUENCER**. The song number and song name are specified before recording begins.

1. Press the **MENU** button in the **SEQUENCER** section to turn it on.

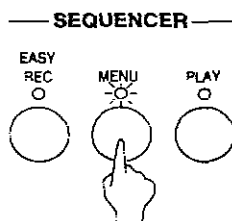

2. On the **SEQUENCER MENU** display, select **SONG SELECT/NAME**.
 - The display looks similar to the following.

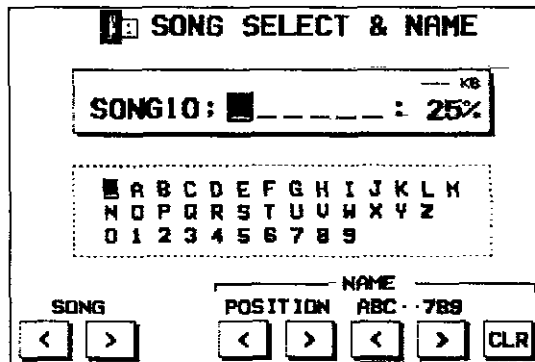

3. Use the **SONG** < and > buttons to select a song number (1 to 10).
4. Assign a name to the song (up to 6 characters).
 - Use the **POSITION** < and > buttons to highlight the character position. Use the **ABC** < and > buttons to select the alphanumeric character. Repeat these steps to type the whole name.
 - To erase the name, press the **CLR** button.
 - The total amount of memory used for the current song is shown as a percentage (%) to the right of the song name.
5. Press the **EXIT** button.

6. Follow the procedures to record the song.

- Until this procedure is repeated, all subsequent recording and playback procedures are associated with the specified song number.
- To optimize memory, songs you do not wish to preserve should be deleted. (Refer to page 75.)
- If you wish to record the tempo for each song, record the desired tempo at the beginning of the **CONTROL** part. When you play back the song, be sure to also select the **CONTROL** part for playback.

Easy Record

Suppose you are playing your instrument and you wish to record and play back your performance to hear how it sounds. You can bypass the set-up procedures of the full-scale sequencer and begin recording quickly and easily.

Recording procedure

1. Set the desired sounds, effects, rhythms, etc.
2. Select the song number. (Refer to page 56.)
3. In the **SEQUENCER** section, press the **EASY REC** button to turn it on.

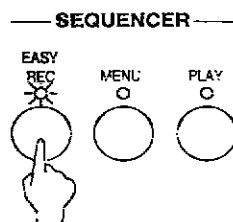

- The display changes to the following.

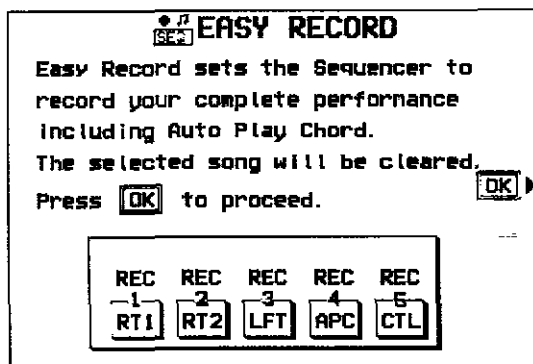

Here is what happens when you select the EASY RECORD mode.

- The recorded data for the currently selected **SONG** number is erased (**SONG CLEAR**).
 - Tracks available for recording are selected as follows.
 - 1: RIGHT 1 part
 - 2: RIGHT 2 part
 - 3: LEFT part
 - 4: APC part
 - 5: CONTROL part
4. Press the **OK** button.
 - The display changes to the **REALTIME RECORD** display.
 5. Play the keyboard.
 - Recording begins as soon as you start the rhythm or play the keyboard.
 6. When you have finished recording, press the **EASY REC** button in the **SEQUENCER** section to turn it off.
 - The display changes to the **SEQUENCER PLAY** display.

Playback

1. Press the **SEQUENCER RESET (FILL IN 1)** button.

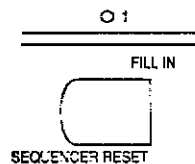

2. Press the **START/STOP** button.
 - Your recorded performance is played back automatically.
 - When you are finished playing back your performance, press the **PLAY** button in the **SEQUENCER** section to turn it off.

Sequencer parts

The following summary explains what is stored in each **SEQUENCER** part.

Part name [name on display]	Used for	Recorded contents
RIGHT1 [RT1] RIGHT2 [RT2] LEFT [LFT] PART4 [P 4] : PART15 [P15]	Recording the performance of each part (REALTIME/STEP)	<ul style="list-style-type: none"> • Sound and volume settings • Pedal operation • DIGITAL EFFECT, DSP EFFECT, SUSTAIN PEDAL on/off • BRILLIANCE setting (RIGHT 1, RIGHT 2, LEFT parts) • PITCH BEND, MODULATION, AFTER TOUCH data (when MIDI data is received)
DRUMS [DRM] (PART16)	Recording the drums performance with the KEYBOARD PERC group sounds (REALTIME/STEP)	<ul style="list-style-type: none"> • Sound (drum KIT) and volume settings
CONTROL [CTL]	Recording changes in the panel button status (REALTIME/STEP)	<ul style="list-style-type: none"> • Rhythm setting and selection changes • RHYTHM VOLUME setting • DIGITAL REVERB on/off • PLAY STYLE (PIANO MODE, KEYBOARD SPLIT, AUTO PLAY CHORD) settings • ON BASS on/off • SPLIT status • MUSIC STYLE ARRANGER status • FILL IN 1, 2, INTRO & ENDING 1, 2 on • PANEL MEMORY selection changes • TRANSPOSE status • START/STOP on/off • TEMPO setting • CONDUCTOR status
AUTO PLAY CHORD [APC]	Recording chords for the AUTO PLAY CHORD (REALTIME)	<ul style="list-style-type: none"> • AUTO PLAY CHORD status • ON BASS on/off • FILL IN 1, 2, INTRO & ENDING 1, 2 on • START/STOP on/off
CHORD [CHD]	Recording the chord progression for the AUTO PLAY CHORD (STEP)	<ul style="list-style-type: none"> • Chord progression • FILL IN 1, 2, INTRO & ENDING 1, 2 on
RHYTHM [RHY]	Settings related to rhythm (STEP)	<ul style="list-style-type: none"> • Rhythm settings and selection changes • FILL IN 1, 2, INTRO & ENDING 1, 2 on • START/STOP on/off • TEMPO setting

- You can use the **TRACK ASSIGN** function to assign parts to tracks as you wish. (Refer to page 69.)
- For the sake of compatibility when playing disks for older **PR** models, the **RKB** and **LKB** playback parts are also supported. However, these parts cannot be recorded or edited.

■ Default part settings

1: RIGHT1	5: CONTROL	9: PART5	13: PART9
2: RIGHT2	6: RHYTHM	10: PART6	14: PART10
3: LEFT	7: DRUMS	11: PART7	15: PART11
4: APC/CHORD	8: PART4	12: PART8	16: PART12

Realtime Record

With REALTIME RECORD, your performance is recorded with the timing exactly as you played it on the keyboard. And with the 16 tracks, you can even record your performance one track at a time (multi-track recording).

Recording procedure

1. Select the song number. (Refer to page 56.)
2. On the **SEQUENCER MENU** display, select **REALTIME RECORD**.
 - The display looks similar to the following.

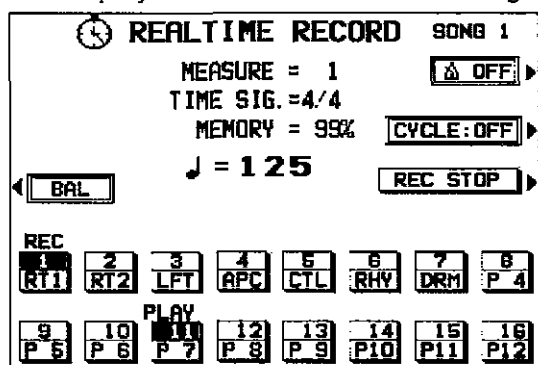

3. Use the buttons below the display to show "REC" above the track numbers you are going to record.
 - Use the upper buttons to select tracks 1 to 8, and the lower buttons to select tracks 9 to 16.
 - While you are recording, you can play back tracks which are already recorded. Press the corresponding buttons to display "PLAY" above the track numbers you wish to have played back.
 - You can select two or more tracks to record at one time. For performance parts, use the **CONDUCTOR** buttons to turn on the parts for the selected tracks (you should be able to hear them).
 - When recording a track for the **AUTO PLAY CHORD (APC)** part, turn on the **AUTO PLAY CHORD** button. In this case, when recording begins, press the **START/STOP** button to begin the rhythm.
 - The track for the **RHYTHM (RHY)** part can be selected for recording only when **STEP RECORD** is active.
4. Set the sounds, effects, and volume as desired.
 - To adjust the volume for each track or part, press the **BAL** button.
 - The settings which are in effect at the time that recording begins are stored at the very beginning of the song.

5. Use the **TEMPO/PROGRAM** dial to adjust the recording tempo.
 - The tempo is shown on the display as a numerical value (♩ =).
 - If you wish to record the tempo setting and tempo changes, select the **CONTROL** part, or use **STEP RECORD: RHYTHM**. (Refer to page 67.)
6. Turn the metronome on or off as desired with the **ON** or **OFF** button.
 - The metronome selection alternates between **ON** and **OFF** each time the button is pressed.
 - The metronome sound is not recorded.
 - When **ON** is selected, the volume balance display is superimposed on the screen. Use the **^** and **v** buttons to adjust the metronome volume.
7. Play the keyboard.
 - Recording begins.
 - The current measure number is shown as "MEASURE=" on the display.
 - You can also press the **START/STOP** button to start the rhythm and begin recording.
 - If the metronome is on, when you press the **START/STOP** button, a two-measure count plays, after which recording automatically begins. In this case, the rhythm does not start.
 - Recording does not start until the two-measure count is completed.
 - The recording status is continuously updated on the display: "TIME SIG.=" indicates the current time signature; and "MEMORY=" indicates the remaining memory (%) available for recording.
 - In some cases, the nuance achieved by pedal operation during recording may be different during playback.
 - If you make a mistake in recording, you can correct a specific portion of your performance without having to redo the whole part. (Refer to page 81.)
 - If you wish to redo the recording or change the recording track, press the **REC STOP** button. The current recording tracks will be in the recording stand-by mode. You can change the panel settings at this time, if desired.

(continued on the next page)

8. When you have finished recording, press the **MENU** button in the **SEQUENCER** section to turn it off.
 - When the **MENU** button is turned off, the ending command (END) is recorded. Note that, as long as the ending command is not recorded, blank recording continues even if you stop playing.
 - The display changes to the **SEQUENCER PLAY** display.

■ **Multi-track recording**

To record the next track immediately after the first track is completed, press the **START/STOP** button. The track you just recorded changes to a "PLAY" track. Use the buttons below the display to show "REC" above the next track you wish to record, and make the various settings (sound, etc.) for the track. Next, press the **START/STOP** button and record the track. The "PLAY" tracks are played back while you record. You can repeat these steps until your multi-track recording is complete.

- For multi-track recording, be sure to press the **START/STOP** button to begin recording.
- If you change the part settings after recording (for example, on the **SOUND SETTING** display) and you wish to store the new settings as the beginning song data, follow the **PANEL WRITE** procedure. (Refer to page 78.)

CYCLE RECORD

This mode allows you to have specified recording measures continuously repeated. Thus you can record measures by adding notes during any cycle.

1. On the **REALTIME RECORD** display, specify "REC" for the track number you are going to record, and "PLAY" for track numbers you wish to have played back.
 - The display looks similar to the following.

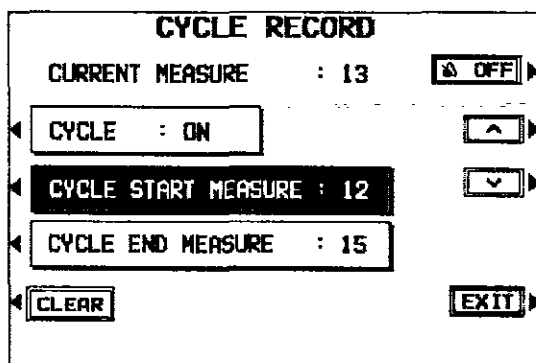

4. Select **CYCLE END MEASURE**, and use the \wedge and \vee buttons to specify the ending measure number.
 - The ending measure you specify becomes the last measure of the cycle.

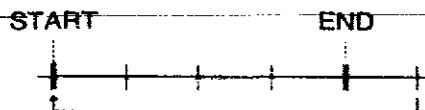

3. Select **CYCLE START MEASURE**, and use the \wedge and \vee buttons to specify the beginning measure number.

5. Press the **START/STOP** button.
 - Cycle recording of the specified measures begins. If the metronome is on, cycle recording begins after a two-measure count.

6. Play the keyboard.

- The specified measures are repeated, during which time you can record by adding notes little by little at the correct timing (over-dubbing).
- If you wish to erase all the performance data from the specified measures, press the CLEAR button.
- The maximum number of notes which can sound simultaneously for a track is 16.
- To return to the REALTIME RECORD display, press the EXIT button.
- Cycle record can also be started from the REALTIME RECORD display whenever the CYCLE: ON indication is shown.
- You can select CYCLE and use the \vee button to turn cycle recording to OFF. This button does not work during recording.

7. When you have finished recording, turn off the MENU button in the SEQUENCER section.

Sequencer Play

Play back your recorded performance.

1. In the SEQUENCER section, press the PLAY button to turn it on.

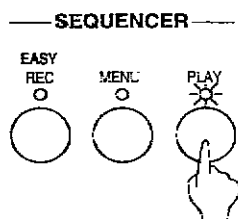

- The display looks similar to the following.

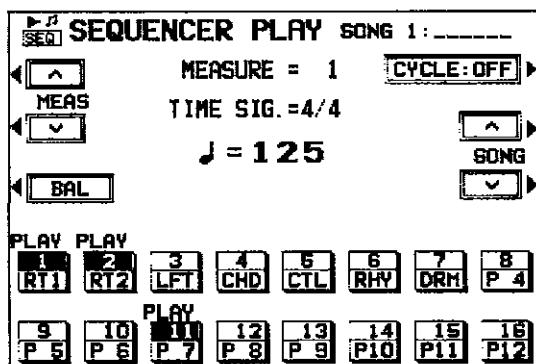

2. Use the SONG \wedge and \vee buttons to select the song number to play back.
 - You can skip this step if you are beginning the playback procedure immediately after recording, because the song number you just recorded will still be selected.

3. Use the buttons below the display to show "PLAY" above the track numbers you wish to have played back.

- Use the upper buttons to select tracks 1 to 8, and the lower buttons to select tracks 9 to 16.
- You can select two or more tracks to play back at one time.

4. Use the TEMPO/PROGRAM dial to adjust the playback tempo.

- The tempo is shown on the display as "♩ =".
- If the tempo was stored in the CONTROL or RHYTHM part, when that part is played back, the stored tempo data has priority.

5. Press the SEQUENCER RESET (FILL IN 1) button.

- The SEQUENCER returns to the beginning of the song and the beginning panel settings are recalled.

6. To begin playback from a measure other than measure 1, use the MEAS \wedge and \vee buttons to specify the beginning measure.

- "MEASURE=" indicates the current measure number.

(continued on the next page)

7. Press the **START/STOP** button.
 - The recorded performance is played back from the specified measure.
 - When playback is begun from a measure in which an **INTRO**, **COUNT INTRO**, **FILL IN** or **ENDING** is recorded, the corresponding function does not work.
 - To adjust the volume for each track or part, press the **BAL** button.
8. To stop playback, press the **START/STOP** button.
 - If the **START/STOP** button is pressed again, playback will continue from the point it was interrupted.
9. When you are finished playing back your performance, press the **PLAY** button in the **SEQUENCER** section to turn it off.
 - During **STEP RECORD** or **EDIT** operations, the **MEASURE** indication on the display conforms to the time signature data recorded in the **RHYTHM** part.

CYCLE PLAY

You can have specified measures played back repeatedly.

1. On the **SEQUENCER PLAY** display, specify "PLAY" for track numbers you wish to have played back.
2. Press the **CYCLE: OFF** button.
 - The display looks similar to the following.

CYCLE PLAY

CURRENT MEASURE : 13

CYCLE : ON ▲

CYCLE START MEASURE : 12 ▼

CYCLE END MEASURE : 15 EXIT ▶

3. Select **CYCLE START MEASURE**, and use the ▲ and ▼ buttons to specify the beginning measure number.
4. Select **CYCLE END MEASURE**, and use the ▲ and ▼ buttons to specify the ending measure number.
 - The ending measure you specify becomes the last measure of the cycle.

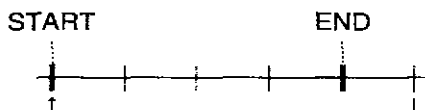

5. Press the **START/STOP** button.
 - Cycle playback of the specified measures begins.
 - The rhythm pattern is not played back.
 - If the **END** command is entered midway through the performance, playback stops at that point. The **NOTE EDIT** can be used to change the position of the **END** command. (Refer to page 70.)
6. To stop cycle playback, press the **START/STOP** button again.
 - During playback stop, if the **SEQUENCER RESET (FILL IN 1)** button is pressed, the **SEQUENCER** returns to the measure number specified in step 3. If the **SEQUENCER RESET** button is pressed again, the **SEQUENCER** returns to measure 1.
 - If **CYCLE** is selected, you can also turn off cycle playback by pressing the ▼ button to select **OFF**.
 - To return to the **SEQUENCER PLAY** display, press the **EXIT** button.
 - Cycle playback can also be specified on the **SEQUENCER PLAY** display whenever the **CYCLE: ON** indication is shown.

8. Specify the pitch and velocity of the note by playing the keyboard.
 - The dot on the display where the note is stored changes to a * mark.
 - When recording chords, you can store multiple notes at one position.
 - Any panel setting changes—for example changes in the sound selection, button operation, etc.—are recorded at the cursor position.
 - When the **TEMPO/PROGRAM** dial is operated, the input value is indicated on the display. Confirm that this is the correct value and press the YES button to record the value or the NO button to cancel it.

REST: To store a rest, after specifying the note LENGTH, press the REST button.

- Positions at which nothing is stored are read as rests.

ERS: If you make a mistake, move the cursor to the error, and after displaying the data you wish to erase, press the ERS button.

BAL: To adjust the volume for each track or part, press the BAL button.

9. Repeat steps 5 through 8 to continue storing notes.
 - To input data on another track, press the button for the desired track and repeat the procedure from step 2.
10. When you have finished recording, press the **MENU** button in the **SEQUENCER** section to turn it off.

■ **Storing control data**

Various control data can be stored at the cursor position.

1. On the **STEP RECORD: MELODY** display, press the CTL button.
- The display looks similar to the following.

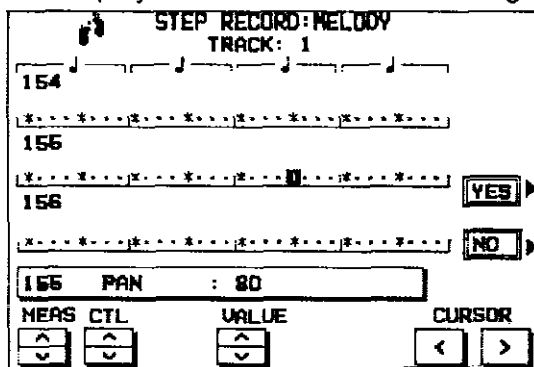

2. Use the CTL ^ and v buttons to select the control data you wish to insert.
 - Select from PAN, KEY SHIFT (COARSE TUNE), TUNING (FINE TUNE), BEND SENS.

3. Use the VALUE ^ and v buttons to adjust the numerical value of the setting.
4. Press YES button.

■ Correcting the data

1. In the STEP RECORD mode, specify the track you wish to correct.
2. Use the MEAS buttons to go to the measure you wish to modify. Use the CURSOR buttons to move the cursor to the point (*) you wish to edit.
 - The data stored at that point is shown on the display.
 - When multiple data is stored at one point, different data is displayed in order each time a CURSOR button is pressed. When a chord is recorded, a different note in the chord is displayed each time a CURSOR button is pressed.
3. Correct the data.

There are three types of data:

Performance data

NOTE data (note pitch) and VEL data (how hard the key was played), etc. are displayed. Use the relevant buttons to correct the data as desired.

Sound data

The name of the sound is displayed. Change the sound as desired (the sound setting display is interposed on the current display).

Control data

The name of the function is displayed. Change the data as desired.

- Press the ERS button to erase the data which is displayed.
- You can also correct data which was stored in the REALTIME RECORD mode.
- Performance (NOTE) data can be recorded or edited on a piano roll display, and there is also a specialized display for recording and editing the DRUMS part data. (Refer to pages 70, 72.)

Store a chord progression

Store the chord progression for the **AUTO PLAY CHORD** in the track for the CHORD part. Then, when the **AUTO PLAY CHORD** is used during playback, even if you do not specify the chords with your left hand, the chords change automatically.

- The chord length is specified with the **CHORD STEP RECORD** keys on the keyboard.



Note value keys

- Whole note
- ◡ Dotted half-note
- ◡ Half-note
- ◡ Dotted quarter-note
- ◡ Quarter-note
- ◡ Eighth-note

Reset key

⏮ Press to begin storing from the beginning.

Correction keys

- ◀ Move back one step.
- ▶ Move forward one step.

Repeat key

↺ Press to end the chord-storing procedure and to specify automatic repeat playback of the stored progression.

End key

→ Press after the whole chord progression has been stored.

DELETE key

DELETE Press to erase data.

- To erase all the data from the current track, while pressing the **DELETE** key, press the End key (→).

■ Example of storing a chord progression

Measure 1	2	3	4
C	C	F G7	C Am
•	•	♪ ♪	♪ ♪

1. Select the song number. (Refer to page 56.)
2. On the **SEQUENCER MENU** display, select **STEP RECORD**.
 - The display changes to the **PART SELECT** display.
3. Using the balance buttons below the display, select the track to which the **CHORD (CHD)** part has been assigned.
 - The display changes to the **STEP RECORD: CHORD** CHORD input display similar to the following.

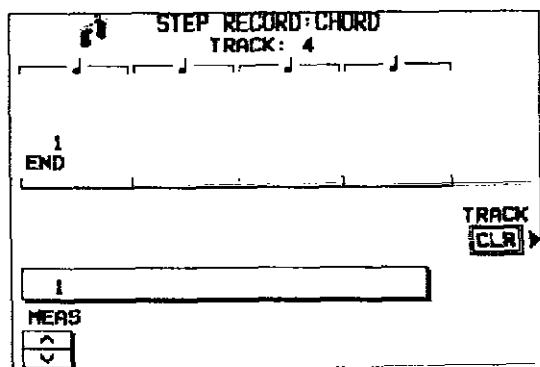

4. Store the chords.

<Measure 1, measure 2>

While playing a C chord with your left hand, press the **•** key one time with your right hand.



- A "beep" tone indicates that the chord has been successfully stored.
- The dot on the display where the chord is stored changes to a * mark and the cursor automatically moves forward, in accordance with the specified note value, to the next unrecorded position. The chord name is shown on the display.

<Measure 3>

- (1) While playing an F chord, press the **•** key one time.



- (2) While playing a G7 chord, press the **•** key one time.

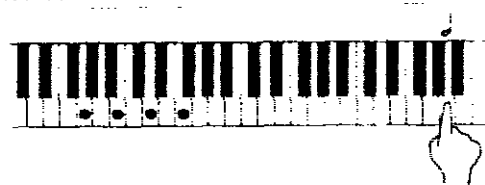

<Measure 4>

- (1) While playing a C chord, press the **•** key one time.

- (2) While playing an Am chord, press the **•** key one time.

- You can press an **INTRO & ENDING** button or a **FILL IN** button on the panel to store the desired pattern at the cursor position. (An **INTRO** or **COUNT INTRO** can be stored only at the beginning.)
- Store a rest by pressing a note value key without specifying a chord.

5. At the end of the chord progression, press the End key (—||).

- This instrument exits the recording mode.
- During playback, playback of the recorded chord progression stops at this point. For automatic repeat playback of the chord progression, press the Repeat key (◁ ▷) instead of the End key (—||).
- When you play back the track for the **CHORD** part, the chords of the automatic accompaniment change in accordance with the stored chord progression.
- If the **AUTO PLAY CHORD BASIC** mode is selected, chords can also be specified in the one-finger mode.
- If the ON status for the **ON BASS** function has been set, chords such as "C on G" can also be specified.

■ **Correct the recorded chord progression**

1. Follow the procedure to select the STEP RECORD: CHORD display.
2. Use the MEAS buttons to go to the measure you wish to modify. Use the ◀ and ▶ Correction keys to move the cursor to the point (*) you wish to edit.

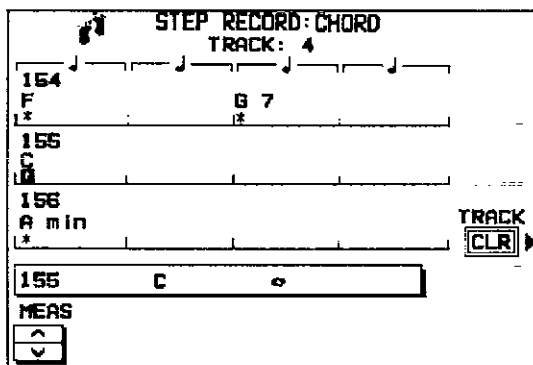

- The lengths of rests are indicated by the respective rest value × its multiplier.

Example:

- ♩ 1-beat rest (quarter rest)
- ♪ 1/2-beat rest (eighth rest)
- ♩ × 1 + ♪ 1-1/2-beat rest (dotted quarter rest)
- ♩ × 10 10-beat rest

- To go to the end of the chord progression, while pressing the Reset key (⏮), press the ◀ key.

3. Correct the chord data.

Chord data

When the chord name is displayed at the cursor position, you can press the DELETE key to erase the data and then store a new chord.

- If you do not erase the displayed data before entering new chord data, the new data is inserted at this point, and the displayed data is merely shifted by the note value of the new chord.
- Rests can also be erased. Each time the DELETE key is pressed, the rest is erased in units of ♩ × 1. The ♩ rest is erased last.

Control data

The name of the stored function (INTRO, FILL, etc.) is displayed. You can press the DELETE key to erase the data which is displayed.

■ **TRACK CLEAR**

To erase all data from the current track, press the CLR button, and then press the YES button on the confirmation display.

- If you wish to cancel the clear procedure, press the NO button.

Store a rhythm progression

Changes in the rhythm selection and tempo, as well as the intro, fill-ins and the ending, can be stored by measures with the step recording method.

1. Select the song number. (Refer to page 56.)
2. On the SEQUENCER MENU display, select STEP RECORD.
 - The display changes to the PART SELECT display.
3. Using the balance buttons below the display, select the track to which the RHYTHM (RHY) part has been assigned.

- The display changes to the STEP RECORD: RHYTHM input display similar to the following.

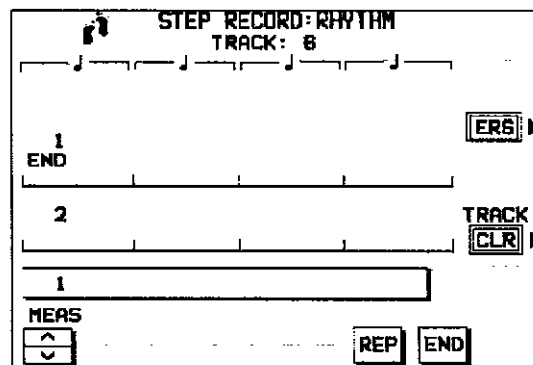

(continued on the next page)

4. Use the MEAS \wedge and \vee buttons to go to the measure you wish to record.
5. Store the rhythm data.
 - Data which can be stored:
 - START/STOP**
Changes in the rhythm selection
 - COUNT INTRO, INTRO, FILL IN, ENDING**
Tempo changes
 - Be sure to store the **START/STOP** data in the measure in which the rhythm starts or stops.
 - If you are storing a **COUNT INTRO** or **INTRO**, store this data before the **START/STOP** data.
 - If the tempo is changed, the display changes to the confirmation display. After specifying the desired tempo, press the YES button to store the specified tempo, or press the NO button to cancel the new tempo value.
6. Repeat steps 4 and 5 to continue storing the rhythm progression.
7. At the end of the rhythm progression, press the END button.
 - If the REP button is pressed instead of the END button, during playback the recorded rhythm progression is repeated.
 - This instrument exits the recording mode.

■ Correct the recorded rhythm progression

1. Follow the procedure to select the STEP RECORD: RHYTHM display.
2. Use the MEAS buttons to go to the measure you wish to modify. (The * is highlighted.)

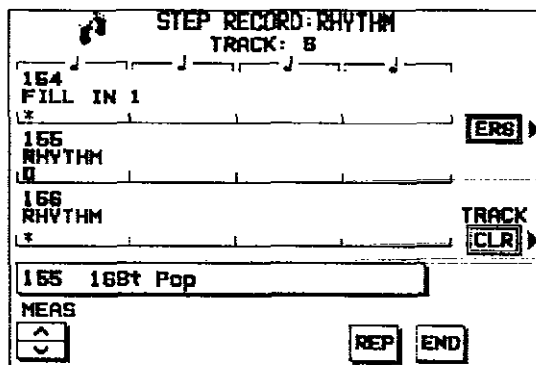

■ TRACK CLEAR

- To erase all data from the current track, press the CLR button, and then press the YES button on the confirmation display.
- If you wish to cancel the clear procedure, press the NO button.

3. Correct the rhythm data.
 - Press the ERS button to erase data at the cursor position.
 - If you select a rhythm with a different time signature, the time signature of all subsequent measures will also change.
 - If data has already been recorded in other tracks, you cannot select a rhythm with a different time signature.

Track Assign

Each **SEQUENCER** part is already assigned to a track number. However, you can use the **TRACK ASSIGN** function to assign parts to tracks as you wish. This function is also used to designate the tracks used for the rhythm data and chord progression data.

1. Select the song number. (Refer to page 56.)
2. On the **SEQUENCER MENU** display, select **TRACK ASSIGN**.
 - The display looks similar to the following.

TRACK	TRACK ASSIGN	LOCAL CONTROL	MIDI OUT CH
TR 1	RIGHT1	ON	1 CH
TR 2	RIGHT2	ON	2 CH
TR 3	PART4	ON	5 CH
TR 4	CHORD	--	-- CH
TR 5	PART5	ON	18 CH
TR 6	PART6	ON	8 CH
TR 7	PART7	ON	9 CH
TR 8	CONTROL	ON	3 CH

3. Use the **TRACK** \wedge and \vee buttons to select the track.
 - You can switch between the setting display for tracks 1 to 8 and the display for tracks 9 to 16 with the **1-8** and **9-16** buttons.
4. Use the **ASSIGN** \wedge and \vee buttons to select the part for the specified track.
 - Select one of the following parts: **RIGHT1**, **RIGHT2**, **LEFT**, **PART4** to **PART15**, **DRUMS**, **CONTROL**, **APC**, **CHORD**, **RHYTHM**. (For an explanation of each **SEQUENCER** part, refer to page 58.)
 - For the sake of compatibility when playing disks for older **PR** models, the **RKB** and **LKB** playback parts are also supported. These parts can be changed, but the user cannot select them. In addition, when either or both the **RKB** and **LKB** parts are active, the **RIGHT 1**, **RIGHT 2**, **LEFT** and **APC** parts cannot be selected.
 - When a part other than the **CONTROL**, **APC/CHORD** or **RHYTHM** part is assigned, the track assign procedure is completed at this point.
 - Either the **CHORD** part or **APC** part can be assigned to a track, but not both.
 - The **RHYTHM**, **CONTROL** and **APC/CHORD** parts cannot be assigned to more than one track.

- You can use the **LOCAL** \wedge and \vee buttons to turn the **LOCAL CONTROL** on or off, and the **CHANNEL** \wedge and \vee buttons to assign the **MIDI OUT CHANNEL**. For a detailed explanation of these **MIDI** functions, refer to pages 121 and 122.

5. When assigning the **CONTROL**, **APC/CHORD** or **RHYTHM** part, press the **OK** button.
 - The confirmation display appears to warn you that currently stored data in the tracks concerned will be erased. Press the **YES** button to confirm that you wish to execute the specified track assignment. Or press **NO** to stop the track assignment.

■ TRACK ASSIGN PRESETS

A preset track assignment can be selected.

1. On the **TRACK ASSIGN** display, press the **PRESETS** button.
 - The display looks similar to the following.



2. Use the **SONG NO/ALL** $<$ and $>$ buttons to select the song number for which the preset track assignment will be effective.
 - If **ALL** is selected, the track assignment is effective for all the songs.
3. Select the track assign mode.
 - Select from the following modes.
 - INITIAL**: Factory-preset settings.
 - TECHNICS MULTI RECORDING**: The optimum track assignment for multiplex recording.
 - GM MULTI RECORDING**: The optimum track assignment for creating **GENERAL MIDI** data.

(continued on the next page)

4. Press the OK button.
 - "COMPLETED!" is shown on the display and the selected track assign mode is enabled.
 - You can confirm the track assignment settings on the TRACK ASSIGN display.

Editing the recorded performance

The edit feature allows you to erase or change portions of your performance after it has been recorded.

Select the edit function

1. Select the number of the song you wish to edit. (Refer to page 56.)
2. On the SEQUENCER MENU display, select EDIT.
 - The EDIT display appears.

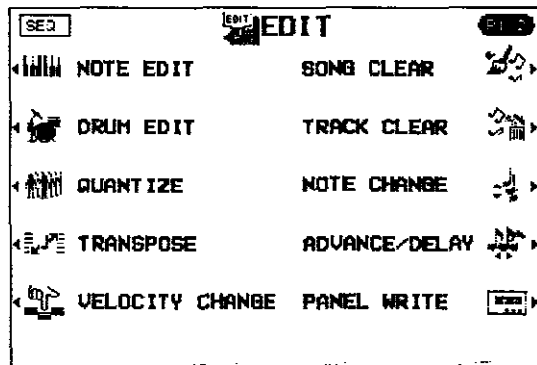

- Use the PAGE ^ and v buttons to view different sections of the menu.

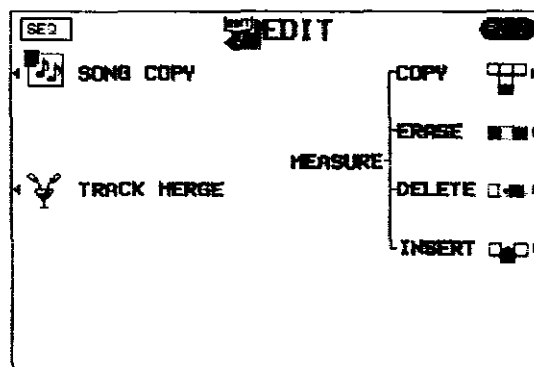

3. Select the edit function.
 - The display changes in accordance with your selection.
4. Perform the editing procedures.
 - During the editing procedure, you can press the EXIT button to go back to the EDIT display.
 - During the editing procedure, if the indicator for the TEMPO/PROGRAM dial is lit, you can use the dial for the editing function.

NOTE EDIT

You can edit performance (NOTE) data on a piano roll display. This differs from the normal STEP RECORD edit procedure, and is a convenient way to check the data for each note.

- Data other than NOTE data cannot be corrected or recorded. To correct or record other types of data, use the STEP RECORD display. (Refer to page 63.)
1. On the PART SELECT display, select a track.
 - The CHORD, RHYTHM and CONTROL tracks cannot be selected.

- The display looks similar to the following.

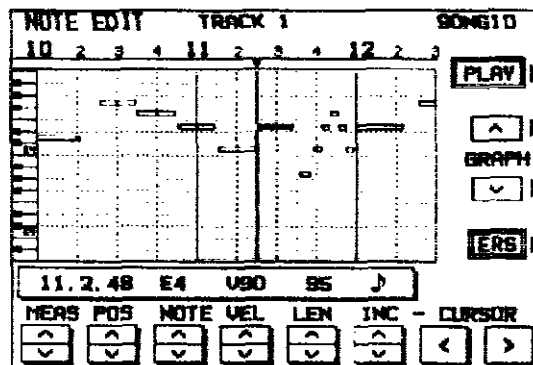

2. Use the MEAS \wedge and \vee buttons to select the measure you wish to edit.

3. Use the CURSOR \lt and \gt buttons to move the cursor (\blacktriangledown) to the point you wish to edit.

- Recorded performance (NOTE) data is shown as horizontal bars. Data selected for editing is highlighted.

- You can use the INC \wedge and \vee buttons to change the increment of cursor movement. The resolution can be set at $\cdot/96$. However, if NOTE data is present between increments, the cursor will stop.

- Use the POS \wedge and \vee buttons to change the value.

Example: 10.2.48 indicates a point in measure 10, beat 2, point 48 (one point is $1/96$ of a quarter note [\cdot]).

- $\#$ is shown at the point where the END command is stored.

4. Select the data to edit (it changes to a highlighted horizontal bar). Edit the data.

- Use the POS \wedge and \vee buttons to move the cursor, the NOTE \wedge and \vee buttons to change the note number, the VEL \wedge and \vee buttons to change the velocity (how hard the keys are played), and the LEN \wedge and \vee buttons to change the note length (1 = $1/96$ of a quarter note [\cdot]).

- Use the GRAPH \wedge and \vee buttons to view a higher or lower section of the keyboard (in one-octave steps).

- If the ERS button is pressed, the selected NOTE data is erased.

5. Repeat steps 2 to 4 to continue editing.

■ Inserting note data

You can also store note data on this display.

1. Specify the point where the new note data will be stored.

2. Use the LEN \wedge and \vee buttons to specify the note length.

- Examples of note lengths ($\cdot = 96$)
 - 91: tenuto (95%)
 - 76: normal (80%)
 - 48: staccato (50%)
 - 24: cutting (25%)

3. Play a key on the keyboard to specify the note pitch (NOTE NUMBER) and velocity (how hard the key is played).

4. Repeat steps 1 to 3 to input more note data.

■ CYCLE PLAY

You can aurally check the data you are editing by accessing the CYCLE PLAY display from the NOTE EDIT display.

- If you wish other tracks to be played back, they should be selected beforehand on the SEQUENCER PLAY display. (Refer to page 61.)

1. On the NOTE EDIT display, press the PLAY button.

- The display looks similar to the following.

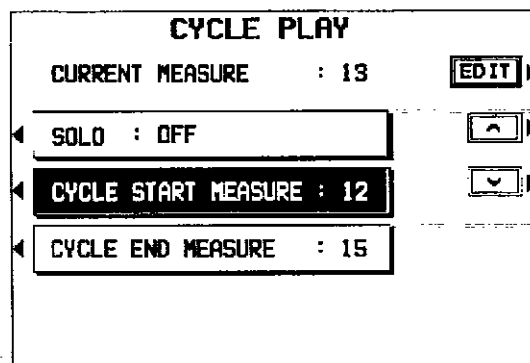

2. Select CYCLE START MEASURE, and use the \wedge and \vee buttons to select the beginning playback measure.

3. Select CYCLE END MEASURE, and use the \wedge and \vee buttons to select the last playback measure.

4. Press the **START/STOP** button.

- Cycle playback of the specified measures begins.
- If the SOLO button is turned ON, playback changes to that of the recording track only. If it is turned OFF, all the tracks specified on the SEQUENCER PLAY display are played back.

5. To stop cycle playback, press the **START/STOP** button again.

- During playback stop, if the **SEQUENCER RESET (FILL IN 1)** button is pressed, the **SEQUENCER** returns to the measure number specified in step 2. If the **SEQUENCER RESET** button is pressed again, the **SEQUENCER** returns to measure 1.

- During playback stop, if the **EDIT** button is pressed, the **SEQUENCER** returns to the NOTE EDIT display.

DRUM EDIT

The DRUMS part can be edited on a specialized display. This differs from the normal STEP RECORD edit procedure, and is a convenient way to check the data for each note.

1. On the PART SELECT display, select the track for the DRUMS part.
 - The display looks similar to the following.

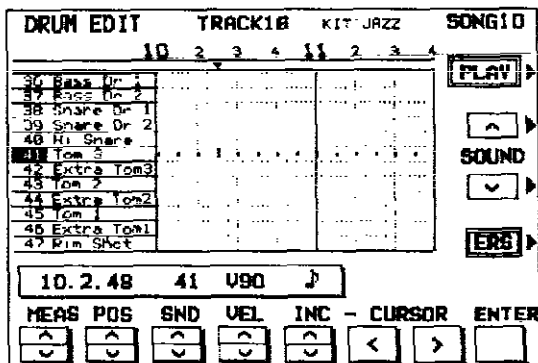

2. Use the SOUND ^ and v buttons to select the percussion instrument you wish to edit.
 - The number to the left of the instrument name is its corresponding key note number.
 - If sounds other than percussion instrument sounds are assigned, they are not displayed.
3. Use the MEAS ^ and v buttons to select the measure you wish to edit.
4. Use the CURSOR < and > buttons to move the cursor (▼) to the point you wish to edit.
 - Recorded performance data is shown as vertical bars. Data selected for editing is shown as a longer vertical bar.
 - You can use the INC ^ and v buttons to change the increment of cursor movement. The resolution can be set at 1/96. However, if NOTE data is present between increments, the cursor will stop.
 - Use the POS ^ and v buttons to change the value.
Example: 10.2.48 indicates a point in measure 10, beat 2, point 48 (one point is 1/96 of a quarter note [♩]).
 - → is shown at the point where the END command is stored.

5. Select the data to edit (it changes to a long bar). Edit the data.
 - Use the POS ^ and v buttons to move the cursor, the SND ^ and v buttons to change the percussion instrument sound, and the VEL ^ and v buttons to change the velocity (how hard the keys are played).
 - If the ERS button is pressed, the selected NOTE data is erased.
6. Repeat steps 2 to 5 to continue editing.

■ Inserting DRUMS data

You can also store DRUMS data on this display.

1. Specify the point where the new note data will be stored.
2. Use the VEL ^ and v buttons to specify the velocity (how hard the key is played).
3. Press the ENTER button to store the data.
 - Instead of the ENTER button, you can store data (including velocity data) by playing the keyboard. In this case, the instrument is that specified on the display, regardless of which key is played.
 - The note length is fixed. If you wish to change the note length, use the STEP RECORD function to specify a different note length. The NOTE EDIT display can also be used to change the length (LEN). (Refer to page 71.)
4. Repeat steps 1 to 3 to input more DRUMS data.

■ CYCLE PLAY

You can aurally check the data you are editing by accessing the CYCLE PLAY display from the DRUM EDIT display.

- The procedure is the same as for NOTE EDIT.
- If you wish other tracks to be played back, they should be selected beforehand on the SEQUENCER PLAY display. (Refer to page 61.)

QUANTIZE

The QUANTIZE function can correct the timing of your performance after it has been recorded. If the rhythm is slightly out of sync or inexact, it will automatically be corrected to the specified quantize level.

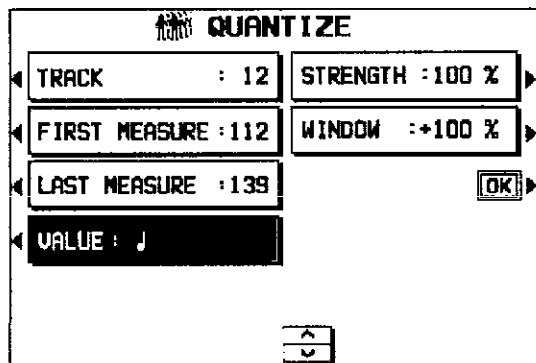

1. Select TRACK. Use the \wedge and \vee buttons to specify the track number.
 - You cannot select the track for the CONTROL, RHYTHM or CHORD part.
 - If ALL is selected, all the tracks are quantized.
2. Select FIRST MEASURE. Use the \wedge and \vee buttons to specify the start point (measure number).
3. Select LAST MEASURE. Use the \wedge and \vee buttons to specify the end point (measure number).
4. Select VALUE. Use the \wedge and \vee buttons to specify the quantize level.
 - Select from ♩, ♪, ♫, ♩3, ♪3, ♫3. (A 3 denotes a triplet-type note.)
5. Select STRENGTH. Use the \wedge and \vee buttons to select the amount of quantize (%).
 - 100% is a convenient setting. When set to 100%, the performance data is quantized exactly to the level specified for the VALUE ("just"). For example, at 50%, the data is quantized to a point that is half that of the just level. By this setting, you can attain an effect that is very slightly off-beat from the rhythm.

Rhythm as written in the score

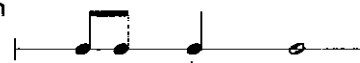

Timing of actual performance

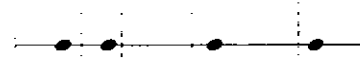

Quantized performance



6. Select WINDOW. Use the \wedge and \vee buttons to specify the range (%) affected by the quantize setting.
 - With the increment set to 100 for the VALUE, at a + setting, data close to the just point is corrected, and at a - setting, data far from the just point is corrected. For example, if set to -30% the quantize function affects data far from the just point, and if set to +30% the quantize function affects data close to the just point. +100% is usually a convenient setting.
 - The +100% setting and the -100% setting are the same.

Example: When VALUE is set to ♩

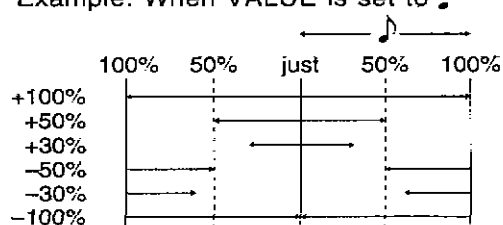

7. Press the OK button.
 - The confirmation display appears. Press the YES button to execute the function, or press the NO button to cancel the function.

TRANSCOPE

Change the key of specific measures of specific tracks.

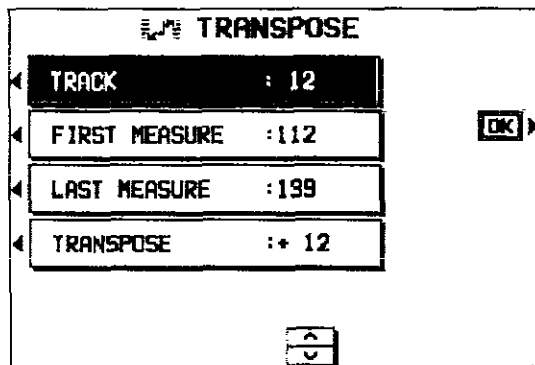

1. Select TRACK. Use the \wedge and \vee buttons to select the track you wish to edit.
 - You cannot select the track for the CONTROL, RHYTHM or CHORD part.
 - If ALL is selected, all tracks will be edited.
2. Select FIRST MEASURE. Use the \wedge and \vee buttons to specify the start point (measure number) of the transpose.
3. Select LAST MEASURE. Use the \wedge and \vee buttons to specify the end point (measure number) of the transpose.

4. Select TRANSCOPE. Use the \wedge and \vee buttons to specify the change in pitch.
 - Increments are in semitones. A value of 12 is one octave. A - value lowers the pitch, and a + value raises it.
5. Press the OK button.
 - The confirmation display appears. Press the YES button to execute the function, or press the NO button to cancel the function.

VELOCITY CHANGE

Modify the recorded velocity in specific measures of specific tracks.

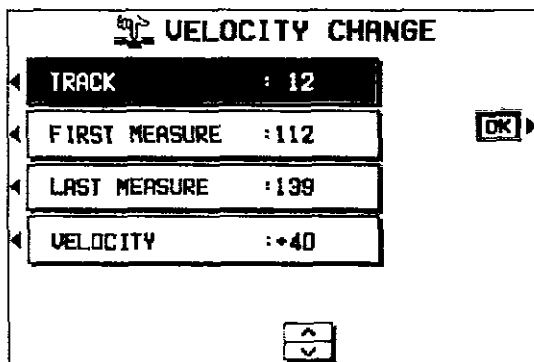

1. Select TRACK. Use the \wedge and \vee buttons to select the track you wish to edit.
 - You cannot select the track for the CONTROL, RHYTHM or CHORD part.
 - If ALL is selected, all tracks will be edited.

2. Select FIRST MEASURE. Use the \wedge and \vee buttons to specify the start point (measure number) of the velocity change.
3. Select LAST MEASURE. Use the \wedge and \vee buttons to specify the end point (measure number) of the velocity change.
4. Select VELOCITY. Use the \wedge and \vee buttons to specify the change in velocity.
 - The value you select will be added to or deleted from the current velocity.
5. Press the OK button.
 - The confirmation display appears. Press the YES button to execute the function, or press the NO button to cancel the function.

SONG CLEAR

Erase the recorded contents of a specified song.

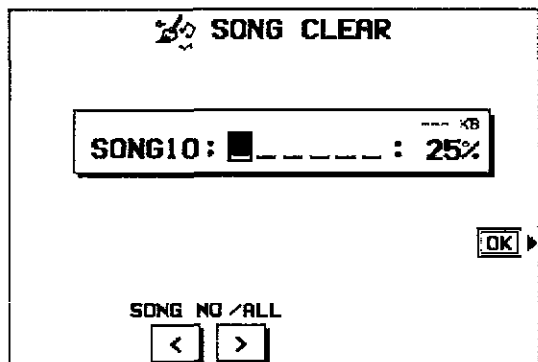

- Use the SONG NO/ALL < and > buttons to specify the number of the song to erase.
 - The total amount of **SEQUENCER** memory (when "ALL" is selected) or current song memory used is shown as a percentage (%) to the right of the song name.
 - If ALL is selected, all the songs recorded in the **SEQUENCER** will be erased.
- Press the OK button.
 - The confirmation display appears. Press the YES button to execute the function, or press the NO button to cancel the function.
 - If the YES button is pressed, "COMPLETED!" appears on the display, the specified songs are erased, and the instrument returns to the normal performance mode.

TRACK CLEAR

Erase the contents of a specific track.

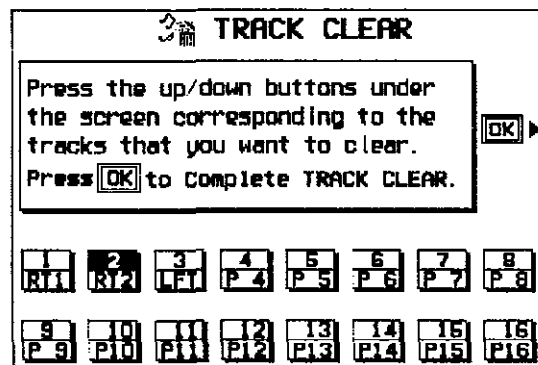

- Use the balance buttons to select the track or tracks you wish to clear.
 - On the display, the selected tracks are highlighted.
- Press the OK button.
 - The confirmation display appears. Press the YES button to execute the function, or press the NO button to cancel the function.
 - If the YES button is pressed, "COMPLETED!" appears on the display, and the specified tracks are erased.

NOTE CHANGE

Change the pitch of specified notes.

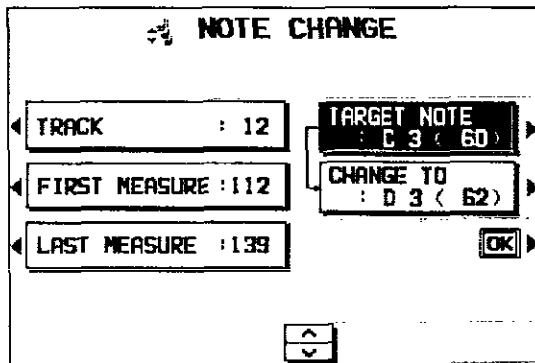

1. Select TRACK. Use the \wedge and \vee buttons to select the track you wish to edit.
 - You cannot select the track for the CONTROL, RHYTHM or CHORD part.
 - If ALL is selected, all tracks will be edited.
2. Select FIRST MEASURE. Use the \wedge and \vee buttons to specify the start point (measure number) of the note change.
3. Select LAST MEASURE. Use the \wedge and \vee buttons to specify the end point (measure number) of the note change.
4. Select TARGET NOTE. Use the \wedge and \vee buttons to specify the pitch of the note you wish to change.
 - The number next to the note name is its note number.
5. Select CHANGE TO. Use the \wedge and \vee buttons to specify the pitch you wish to change to.
6. Press the OK button.
 - The confirmation display appears. Press the YES button to execute the function, or press the NO button to cancel the function.

ADVANCE/DELAY

Speed up or delay the sound production of specified performance data.

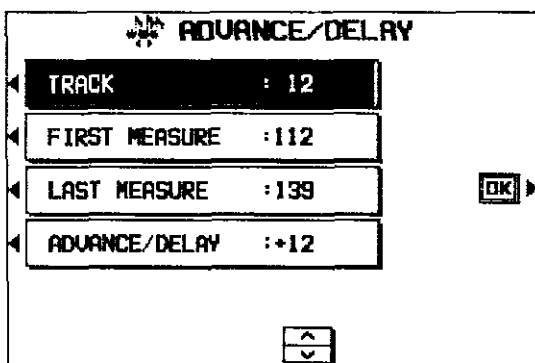

1. Select TRACK. Use the \wedge and \vee buttons to select the track you wish to edit.
 - You cannot select the track for the CONTROL, RHYTHM or CHORD part.
 - If ALL is selected, all tracks will be edited.
2. Select FIRST MEASURE. Use the \wedge and \vee buttons to specify the start point (measure number) of the change.
3. Select LAST MEASURE. Use the \wedge and \vee buttons to specify the end point (measure number) of the change.
4. Select ADVANCE/DELAY. Use the \wedge and \vee buttons to accelerate or delay the timing of the sound production (-96 to +96).
 - A + value causes the notes to sound later, and a - value causes the notes to sound earlier.
5. Press the OK button.
 - The confirmation display appears. Press the YES button to execute the function, or press the NO button to cancel the function.

SONG COPY

Copy the recorded data from specific tracks of a song.

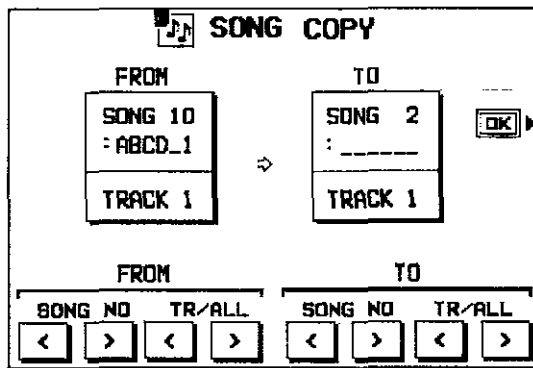

1. On the FROM side, use the SONG NO < and > buttons to specify the song number to copy from.
2. On the FROM side, use the TR/ALL < and > buttons to specify the number of the track to copy from.
 - If ALL is selected, all the tracks of the specified song number will be copied.
3. On the TO side, use the SONG NO < and > buttons to specify the song number to copy to.
4. On the TO side, use the TR/ALL < and > buttons to specify the number of the track to copy to.
 - If ALL is selected, the data will be copied to all the tracks of the specified song number.
5. Press the OK button.
 - The confirmation display appears. Press the YES button to execute the function, or press the NO button to cancel the function.
 - The track assignment settings are also copied. Note that in some cases, the CONTROL, RHYTHM and CHORD part data in the destination tracks may be lost.

TRACK MERGE

Merge the recorded contents of two tracks (source tracks) and store the merged contents in a third track (destination track).

- When the TRACK MERGE function is executed, the data is erased from the two source tracks.

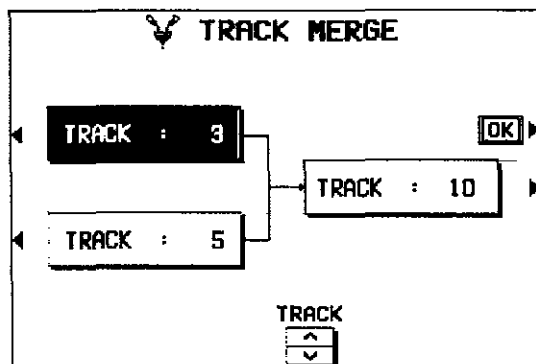

1. Select the two source tracks (left half of the display).
 - Use the buttons on the left side of the display to select one of the source tracks, and use the TRACK ^ and v buttons to specify the track number. Repeat for the other source track.
 2. Select the destination track (right half of the display).
 - Press the button on the right side of the display to select the destination track, and use the TRACK ^ and v buttons to specify the track number.
 3. Press the OK button.
 - The confirmation display appears. Press the YES button to execute the function, or press the NO button to cancel the function.
- You cannot select the track to which the CONTROL, RHYTHM or CHORD part has been assigned.
 - If the part assigned to the upper source track ("upper" meaning its position on the TRACK MERGE display) is different from the part assigned to the lower source track, when the parts are merged in the destination track, the new track is assigned the same part as the upper track.

PANEL WRITE

You can change the panel status which is in effect at the beginning of the song. These are the settings which are recalled when the **SEQUENCER RESET** button is pressed.

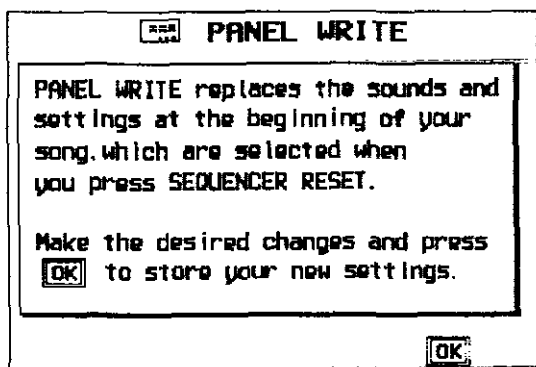

1. Use the panel buttons to change to the desired panel settings.
2. Press the OK button.
 - "COMPLETED!" is shown on the display.
 - PANEL WRITE is automatically activated at the beginning of the recording operation, or when a panel setting is changed during recording stop.

MEASURE COPY

Copy recorded data of specified measures to a specified point.

- On the destination track, the new data replaces the current measure contents.

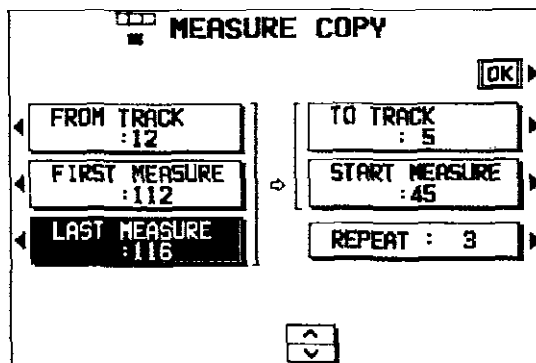

1. Select FROM TRACK. Use the \wedge and \vee buttons to specify the source track.
 - You cannot select the track for the RHYTHM part or CHORD part in which a repeat command has been stored.
 - If ALL is selected, the specified measures are copied to all tracks at the same time.
2. Select FIRST MEASURE. Use the \wedge and \vee buttons to specify the start point (measure number) on the source track.
3. Select LAST MEASURE. Use the \wedge and \vee buttons to specify the end point (measure number) on the source track.

4. Select TO TRACK. Use the \wedge and \vee buttons to specify the destination track.
 - Measures in a track for the CONTROL, RHYTHM or CHORD part can be copied only to the same track.
5. Select START MEASURE. Use the \wedge and \vee buttons to specify the start point (measure number) on the destination track.
6. Select REPEAT. Use the \wedge and \vee buttons to specify the number of times the specified measures are to be repeated.
 - The measures will be repeated the specified number of times.
7. Press the OK button.
 - The confirmation display appears. Press the YES button to execute the function, or press the NO button to cancel the function.
 - Note that if the END command is included in the source data, it is also copied. Any data following the END command is not copied.

MEASURE ERASE

Erase the recorded contents of specific measures. You can also specify which type of data is to be erased.

- Note that only the contents of the measures are erased, not the measures themselves; the length of the performance remains the same.

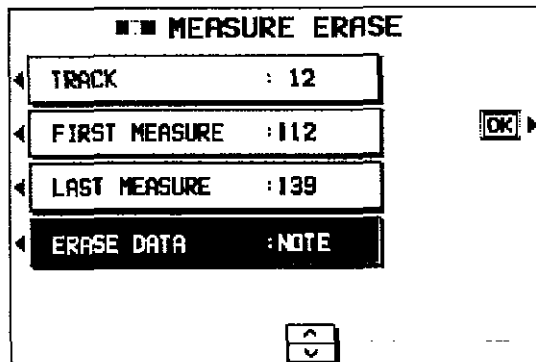

1. Select TRACK. Use the \wedge and \vee buttons to specify the track number.
- This function does not work for the RHYTHM part or CHORD part in which a repeat command has been stored.
- If ALL is selected, data is erased from the specified measures of all the tracks at one time.

2. Select FIRST MEASURE. Use the \wedge and \vee buttons to specify the start point (measure number).

3. Select LAST MEASURE. Use the \wedge and \vee buttons to specify the end point (measure number).

4. Select ERASE DATA. Use the \wedge and \vee buttons to specify the type of data to be erased.

ALL: All data is erased.

NOTE: Only note data.

CONTROL: Only control data (volume, effect and other panel settings as well as selection changes) is erased.

5. Press the OK button.

- The confirmation display appears. Press the YES button to execute the function, or press the NO button to cancel the function.

MEASURE DELETE

Delete specified measures from a track.

- The length of the performance accordingly decreases by the number of deleted measures.

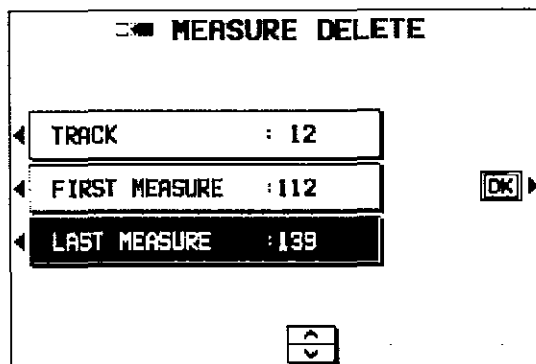

1. Select TRACK. Use the \wedge and \vee buttons to select the track from which measures are to be deleted.

- This function does not work for the CHORD or RHYTHM track in which the repeat function has been stored.

- If ALL is selected, the specified measures are deleted from all the tracks at one time.

2. Select FIRST MEASURE. Use the \wedge and \vee buttons, to specify the first measure to delete.

3. Select LAST MEASURE. Use the \wedge and \vee buttons to specify the last measure to delete.

4. Press the OK button.

- The confirmation display appears. Press the YES button to execute the function, or press the NO button to cancel the function.

MEASURE INSERT

Insert specified measures at a specified point.

- The length of the performance accordingly increases by the number of inserted measures.

The screenshot shows a dialog box titled "MEASURE INSERT". It contains the following fields and controls:

- FROM TRACK :** 12
- TO TRACK :** 5
- FIRST MEASURE :** 112
- START MEASURE :** 45
- LAST MEASURE :** 116
- REPEAT :** 3
- An **OK** button in the top right corner.
- Up and down arrow buttons at the bottom center.

1. Select FROM TRACK. Use the \wedge and \vee buttons to select the source track.
 - This function does not work for the CHORD or RHYTHM track in which the repeat function has been stored.
 - If ALL is selected, the measures are inserted in all tracks at the same time.
2. Select FIRST MEASURE. Use the \wedge and \vee buttons to specify the first measure on the source track from which to copy.
3. Select LAST MEASURE. Use the \wedge and \vee buttons to specify the last measure on the source track from which to copy.
4. Select TO TRACK. Use the \wedge and \vee buttons to specify the destination track.
 - Measures from the CHORD, RHYTHM or CONTROL track can only be inserted in the same track.
5. Select START MEASURE. Use the \wedge and \vee buttons to specify the insert point on the destination track.
6. Select REPEAT. Use the \wedge and \vee buttons to specify the number of times the specified measures are to be inserted.
 - The measures will be inserted the specified number of times.
7. Press the OK button.
 - The confirmation display appears. Press the YES button to execute the function, or press the NO button to cancel the function.
 - Note that if the END command is included in the source data, it is also inserted. Any data following the END command is not inserted.

Punch Record

If you make a playing error during **REALTIME RECORD** or would like to change the recording for some other reason, you can use the punch recording feature to correct a selected portion of the performance without having to redo the whole part.

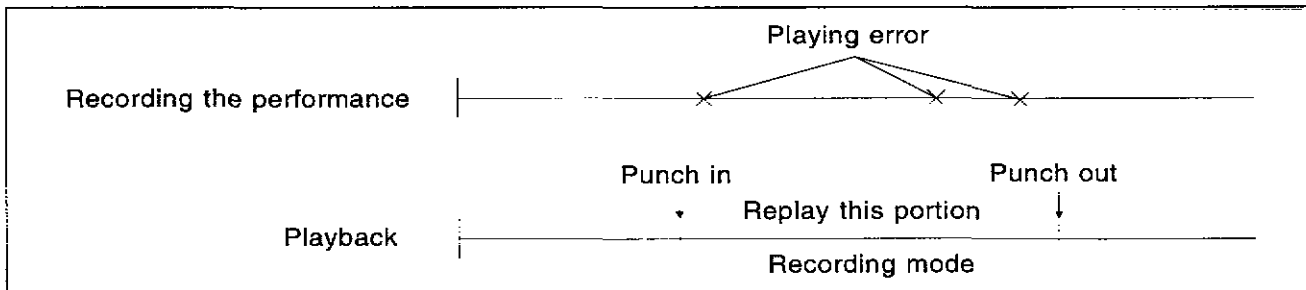

1. Select the song number. (Refer to page 56.)
2. On the **SEQUENCER MENU** display, select **PUNCH RECORD**.
 - The display looks similar to the following.

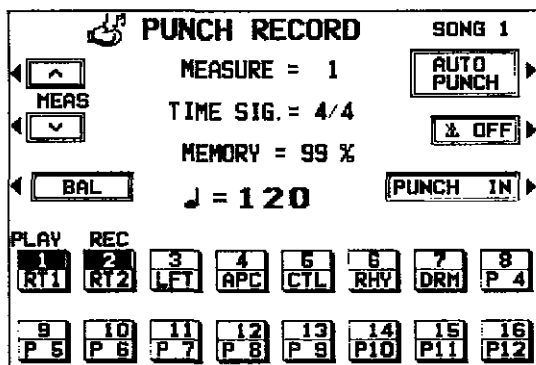

3. Select the track which contains the portion you want to correct.
 - On the display "REC" indicates tracks which are being recorded, and "PLAY" indicates tracks which are being played back.
4. Use the **MEAS** \wedge and \vee buttons to specify the beginning measure of playback.
 - "MEASURE=" indicates the current measure number.
5. Press the **START/STOP** button to begin playback of the specified track.
6. During playback, press the **PUNCH IN** button at the point you want to begin recording.
 - Recording begins as soon as the **PUNCH IN** button is pressed. Begin playing at this point.
 - The **PUNCH IN** button switches to the **PUNCH OUT** button.

7. Press the **PUNCH OUT** button at the point you want to stop recording.
 - Recording stops immediately.
8. When you have finished correcting the performance, press the **MENU** button in the **SEQUENCER** section to turn it off.

- You can also begin punch-in recording by playing the keyboard.
- You can specify the punch-in/punch-out points with the soft pedal or the sostenuto pedal. (Refer to page 53.)
- To adjust the volume for each track or part, press the **BAL** button.

■ AUTO PUNCH RECORD

You can also set the punch-in and punch-out points beforehand, so that recording automatically begins and ends at the specified points.

1. On the **SEQUENCER MENU** display, select **PUNCH RECORD**. Specify the track you wish to correct.
2. Press the **AUTO PUNCH** button.
 - The display looks similar to the following.

AUTO PUNCH RECORD

CURRENT MEASURE : 18

PUNCH IN MEASURE : 20 **OFF**

PUNCH OUT MEASURE : 25 **MEAS**

MEASURE COUNT IN : 2 **MEAS**

Press the **START/STOP** button to begin

3. Select **PUNCH IN MEASURE**. Use the **MEAS** **^** and **v** buttons to specify the number of the punch-in measure.
4. Select **PUNCH OUT MEASURE**. Use the **MEAS** **^** and **v** buttons to specify the number of the punch-out measure.
 - The number of the punch-out measure must be higher than the number of the punch-in measure.
 - The specified punch-out measure is not recorded.
5. Select **MEASURE COUNT IN**. Use the **^** and **v** buttons to specify the number of lead-in measures you wish to have played back before the punch-in measure.
 - Set the metronome to on or off with the **ON** or **OFF** button.
6. Press the **START/STOP** button.
 - Playback begins from the measure indicated by **CURRENT MEASURE** on the display.
7. Correct the performance.
 - The mode changes automatically to the recording mode at the specified punch-in measure. Begin playing at this point. The mode automatically changes back to the playback mode at the specified punch-out measure.
 - Punch-in recording also begins if the keyboard is played before the specified **PUNCH IN MEASURE**.
8. When you have finished correcting the performance, press the **MENU** button in the **SEQUENCER** section to turn it off.

Sequencer Medley

You can have the songs played back continuously in order. Songs saved on a disk can also be played back in a medley.

1. On the **SEQUENCER MENU** display, select **MEDLEY**.
 - The display looks similar to the following.

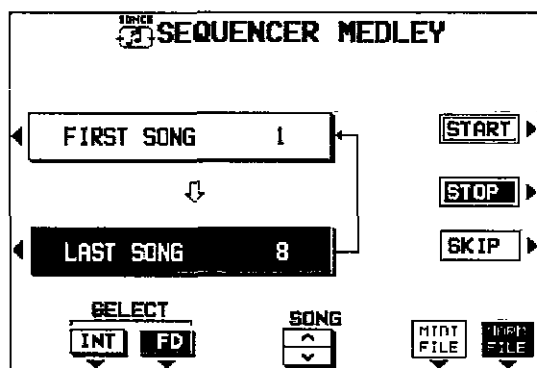

2. Use the **SELECT** buttons to specify the item you wish to have played.
 - Press the **INT** button to specify medley play of songs in this instrument's **SEQUENCER**, or press the **FD** button to specify songs on the floppy disk.
 - Note that if **FD** is selected and medley play is executed, all song data (**SONG 1-10**) currently stored in the **SEQUENCER** memory is erased.
3. If **FD** is selected, use the **MIDI FILE/NORM FILE** button to select the kinds of files for medley play.
 - Select **MIDI FILE** to play Standard MIDI Files (**FORMAT 0** only), or select **NORM FILE** to play Technics files.
4. Select **FIRST SONG**. Use the **SONG** \wedge and \vee buttons to specify the first song you wish to have played.
5. Select **LAST SONG**. Use the **SONG** \wedge and \vee buttons to specify the last song.
6. Press the **START** button.
 - The songs are played back in the specified order.
 - You can use the **SKIP** button to skip to the next song.

7. To stop medley play, press the **STOP** button.
 - Features and operation of the Disk Drive are explained in "Part V Disk Drive" (page 97).

- You can access this setting display from the **MEMORY & CONTROL** menu display. (Refer to page 98.)
- Songs on **DISK ORCHESTRA COLLECTION™** (**DOC**) and **PianoDisc™** disks can also be played back in a medley.
 - * **DISK ORCHESTRA COLLECTION** is a trademark of the **YAMAHA** Corporation.
 - * **PianoDisc** is a registered trademark of **Music Systems Research**.



Part IV Composer

Outline of the Composer

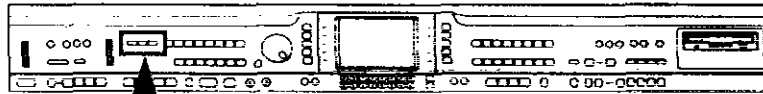

The **COMPOSER** enables you to create your own accompaniment patterns or to edit preset accompaniment patterns. A pattern is comprised of five parts: **DRUMS**, **BASS** and three **ACCOMP** parts. These parts would form the backing of a song, for example: Drums, Acoustic Bass, Piano, Jazz Guitar and Vibes. You may find it useful at first to copy and edit a preset pattern.

Rhythm components which can be stored

You can store up to 12 different rhythms (4 in each memory bank **A**, **B**, **C**).

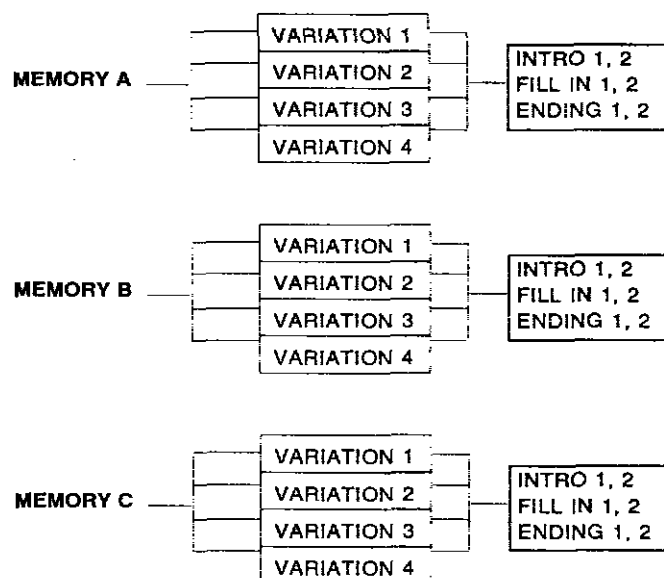

- You can also create **INTRO**, **FILL IN** and **ENDING** patterns for each **MEMORY (A, B, C)**. These patterns are played back when the **COMPOSER MODE** is set to **EXPAND**. (Refer to page 94.)

Memory capacity

Expressed in terms of notes, the total number of notes which can be stored in all the **COMPOSER** memories is about 10,000. The remaining memory available for recording is shown on the **RECORD** display as a percentage (**MEMORY= %**).

- When "Memory full!" appears on the display no more data can be stored in the **COMPOSER**.
- The recorded **COMPOSER** data can be saved to a disk and later quickly recalled (**COMPOSER LOAD**). (Refer to page 99.)

COMPOSER RECORD menu

When you press the **RECORD** button in the **COMPOSER** section to turn it on, the display changes to the following.

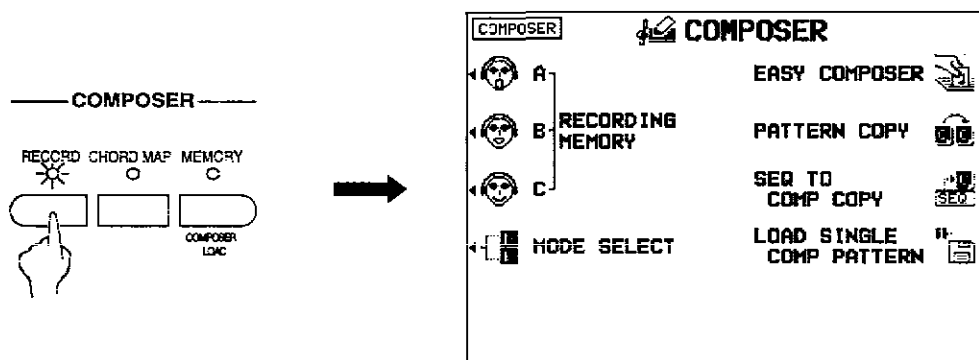

Summary of the COMPOSER RECORD menu items

RECORDING MEMORY-A

Create a memory in the **MEMORY A** bank.

RECORDING MEMORY-B

Create a memory in the **MEMORY B** bank.

RECORDING MEMORY-C

Create a memory in the **MEMORY C** bank.

EASY COMPOSER (page 86)

Create a rhythm pattern with a simplified procedure.

MODE SELECT (page 94)

Specify whether or not you are playing back your own **INTRO**, **FILL IN** and **ENDING** patterns.

PATTERN COPY (page 87)

Copy a preset rhythm pattern into a memory.

SEQ TO COMP COPY (page 90)

Copy data in the **SEQUENCER** to the **COMPOSER**.

LOAD SINGLE COMP PATTERN

Recall the desired **COMPOSER** data from data saved on a disk. The items on this menu are also on the **DISK LOAD** menu, and the procedures are the same (page 99).

Three ways to record in the COMPOSER

There are three ways to create and record a rhythm.

■ Simple recording method (page 86)

Use **EASY COMPOSER** to quickly create a unique rhythm just by selecting a style and variation for each part.

■ Edit a preset rhythm (pages 87 and 91)

Use the **PATTERN COPY** function to copy a preset rhythm to a **MEMORY**, change parts of it, and then store it as a new rhythm.

■ Create a completely new rhythm (pages 88 and 91)

Clear the memories and compose a completely new rhythm from scratch.

- You can use either or both of two recording methods. Realtime recording allows you to store your rhythm exactly as you play it on the keyboard. But for difficult phrases, you may want to use the **STEP RECORD** mode to store the notes one by one, just as you might write a music score.

Simple recording method

With EASY COMPOSER you can easily create a unique rhythm pattern by selecting a different style for each part of the rhythm.

1. On the **COMPOSER RECORD** menu display, select **EASY COMPOSER**.
 - The display looks similar to the following.

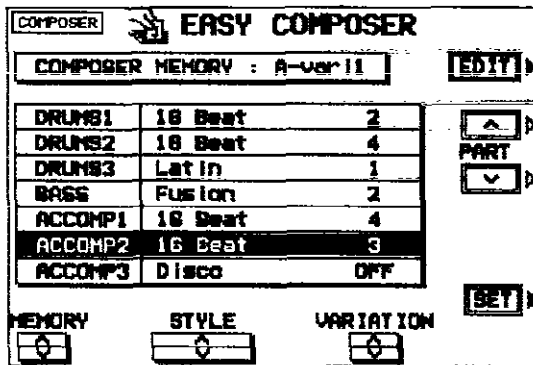

2. Use the **MEMORY** ▲ and ▼ buttons to select the memory in which to record your rhythm.
 - Select from A-vari 1 to 4, B-vari 1 to 4 and C-vari 1 to 4.
3. Use the **PART** ▲ and ▼ buttons to select the part.
 - In the **EASY COMPOSER**, the new rhythm pattern is divided into 7 parts, to each of which a style and variation is assigned.
4. Use the **STYLE** ▲ and ▼ buttons to select a style.
5. Use the **VARIATION** ▲ and ▼ buttons to select the variation number.
 - The number of variations differs depending on the selected style.
 - A part which is set to **OFF** does not sound. Note that the **DRUMS1** part cannot be set to **OFF**.
6. Repeat steps 3 to 5 to select styles for the other parts.

7. Press the **SET** button.

- The rhythm pattern is played back.
- The **RHYTHM** name changes to "Easy."
- If you are not satisfied with the rhythm pattern, repeat steps 3 to 7.
- If you wish to correct the sounds or phrases in your rhythm pattern, press the **EDIT** button. The display changes to the recording display. (Refer to page 91.)

- For playback, refer to page 92.

Edit a preset rhythm pattern: preparation

These are step-by-step instructions for preparing to create a new rhythm pattern by modifying a part of a preset rhythm pattern. First you copy one of the preset **RHYTHM GROUP** rhythm patterns to a location in the specified **MEMORY** bank.

- Data can also be copied from the **SEQUENCER**. (Refer to page 90.)

1. On the **COMPOSER RECORD** menu display, select **PATTERN COPY**.
 - The display looks similar to the following.

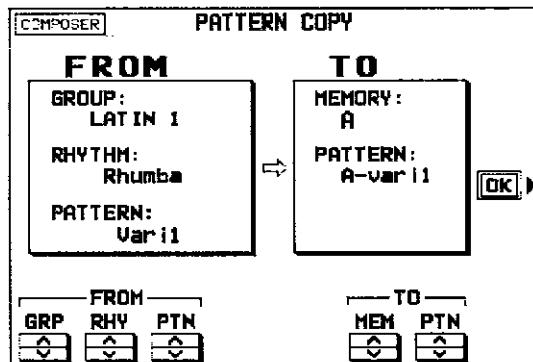

2. Select a rhythm group, name and pattern to copy (FROM).
 - Use the **GRP** \wedge and \vee buttons to specify the **RHYTHM GROUP**.
 - Use the **RHY** \wedge and \vee buttons to specify the rhythm name.
 - Use the **PTN** \wedge and \vee buttons to specify the rhythm pattern.
 - You can also select the **RHYTHM GROUP** and rhythm with the panel buttons.
3. Select a memory bank and pattern to copy to (TO).
 - Use the **MEM** \wedge and \vee buttons to specify the memory bank (A, B or C).
 - Use the **PTN** \wedge and \vee buttons to specify the pattern.

4. Press the **OK** button.
 - When copying has been successfully completed, "COPY COMPLETED!" appears on the display.

5. Press the **EXIT** button.

6. On the **COMPOSER RECORD** menu display, select the bank to which you copied the rhythm pattern (the memory bank you selected in step 3: **RECORDING MEMORY-A**, **RECORDING MEMORY-B** or **RECORDING MEMORY-C**).
 - The display looks similar to the following.

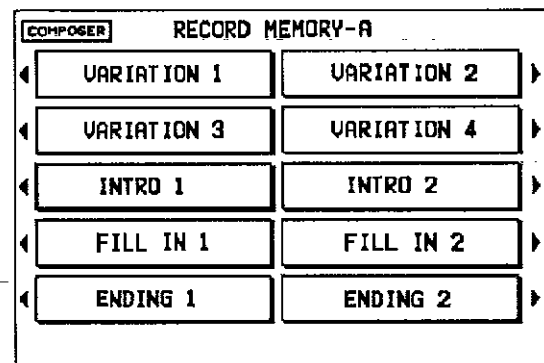

7. Select the pattern name to which you copied the pattern (the pattern name you selected in step 3).
 - The display looks similar to the following.

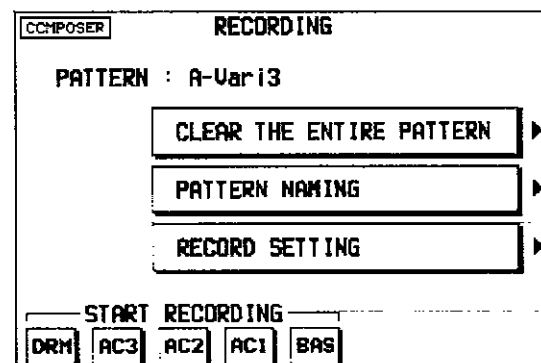

(continued on the next page)

8. If you wish to name your new rhythm pattern (except for FILL IN, INTRO and ENDING), select PATTERN NAMING.
 - If you do not input a name for your rhythm pattern, the name becomes the same as the original rhythm from which you copied.
 - The display looks similar to the following.

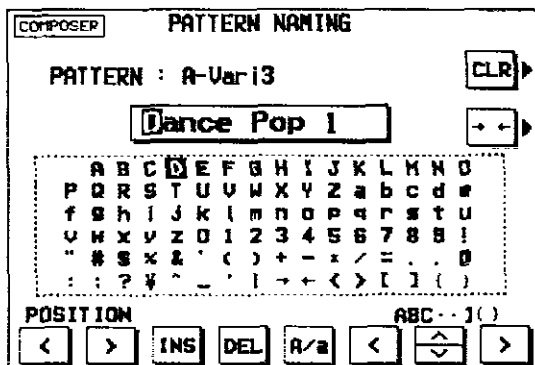

9. Type a new name for your rhythm pattern (up to 12 characters).
 - Use the POSITION < and > buttons to highlight the character position in the name box.
 - Use the ABC ··] { } buttons to select the alphanumeric character. Repeat these steps to type the whole name.
 - Use the INS button to type a space.
 - Use the DEL button to erase a character.
 - Use the A/a button to switch between upper case and lower case characters.
 - To erase all the characters, press the CLR button.
 - You can press the → ← button if you wish to have the name centered.

10. Press the EXIT button.
 - The display returns to the previous display.
11. In the START RECORDING area on the display, select the rhythm part you want to record first.
 - BAS: BASS
 - AC1: ACCOMP 1
 - AC2: ACCOMP 2
 - AC3: ACCOMP 3
 - DRM: DRUMS
 - The pattern you copied and the metronome sound start, and recording begins. (Refer to page 91.)

Create a completely new rhythm: preparation

Here are the preparatory steps to compose a completely new rhythm from scratch.

1. On the COMPOSER RECORD menu display, select a bank in which to record the rhythm (RECORDING MEMORY-A, RECORDING MEMORY-B or RECORDING MEMORY-C).
 - The display looks similar to the following.

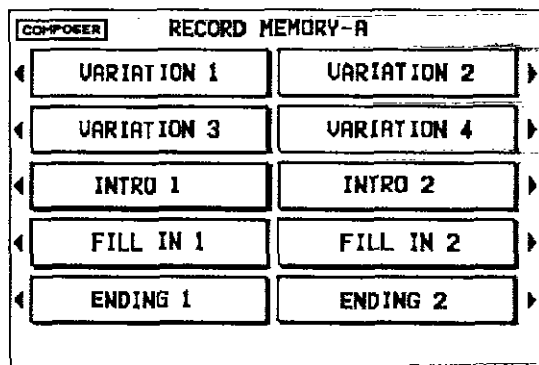

2. Specify the pattern you are going to create.
 - The display looks similar to the following.

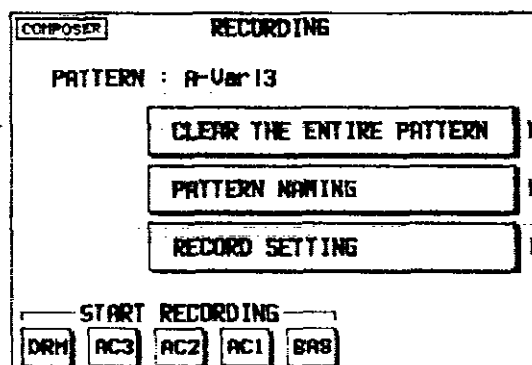

3. Press the CLEAR THE ENTIRE PATTERN button.
 - The following confirmation display appears. Press the YES button to execute the function, or press the NO button to cancel the function.

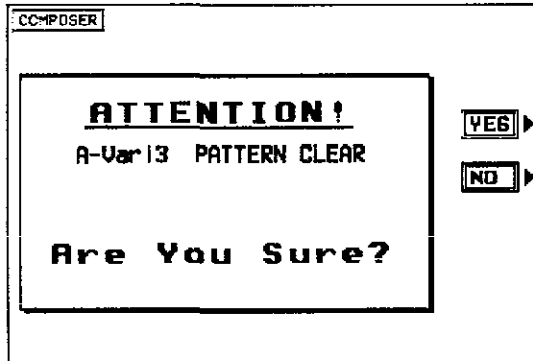

4. Select PATTERN NAMING (except for FILL IN, INTRO and ENDING).
 - The display looks similar to the following.

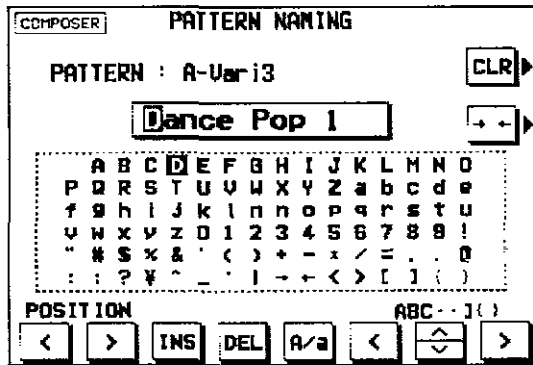

5. Type a name for your rhythm pattern (up to 12 characters).
 - Use the POSITION < and > buttons to highlight the character position in the name box.
 - Use the ABC . .] () buttons to select the alphanumeric character. Repeat these steps to type the whole name.
 - Use the INS button to type a space.
 - Use the DEL button to erase a character.
 - Use the A/a button to switch between upper case and lower case characters.
 - To erase all the characters, press the CLR button.
 - You can press the → ← button if you wish to have the name centered.
6. Press the EXIT button.
 - The display returns to the previous display.

7. Select RECORD SETTING.
 - The display looks similar to the following.

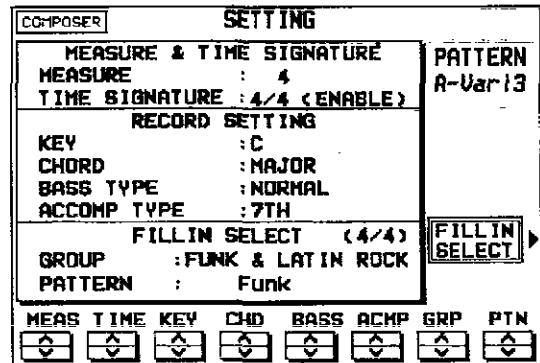

8. Adjust the various recording settings.
 - See the "Recording settings" below.
9. When all the settings have been completed, press the EXIT button.
 - The display returns to the previous display.
10. In the START RECORDING area on the display, select the rhythm part you want to record first.
 - BAS: BASS
 - AC1: ACCOMP 1
 - AC2: ACCOMP 2
 - AC3: ACCOMP 3
 - DRM: DRUMS
 - The metronome sound starts and recording begins. (Refer to page 91.)



■ Recording settings

MEASURE & TIME SIGNATURE

These settings can be adjusted only when the pattern has been cleared by the CLEAR THE ENTIRE PATTERN function.

MEASURE: Use the MEAS \wedge and \vee buttons to specify the number of measures in your repeating rhythm pattern.

TIME SIGNATURE: Use the TIME \wedge and \vee buttons to specify the time signature.

RECORD SETTING

KEY: Use the KEY \wedge and \vee buttons to specify the root note of the chords you wish to record.

CHORD: Use the CHD \wedge and \vee buttons to specify the type of chord you wish to record (MINOR or MAJOR).

BASS TYPE: Use the BASS \wedge and \vee buttons to specify the type of phrase progression for the **BASS** part (NORMAL or 7TH).

ACCOMP TYPE: Use the ACMP \wedge and \vee buttons to specify the type of phrase progression for the **ACCOMP** parts (NORMAL or 7TH).

FILL IN SELECT

You can select fill-in, intro and ending patterns from a preset rhythm pattern. These preset patterns are produced when a **FILL IN** button or the **INTRO & ENDING** button is pressed during playback of your new rhythm pattern.

- This setting is effective only when the **COMPOSER MODE** is set to **NORMAL MODE**.

GROUP: Use the GRP \wedge and \vee buttons to specify the **RHYTHM GROUP**.

PATTERN: Use the PTN \wedge and \vee buttons to specify the rhythm name.

- If you changed the settings in the **FILL IN SELECT** area on the display, press the **FILL IN SELECT** button. When the settings have been successfully stored, "COPY COMPLETED!" appears on the display.
- You cannot select a rhythm with a time signature different from that of the time signature you specified.

Sequencer to Composer Copy

Data from the **SEQUENCER** can be copied to a **COMPOSER** memory. For example, you can use a rhythm pattern on a song disk as the automatic accompaniment for your own performance.

1. Play back the song you wish to copy from **SEQUENCER** to confirm the tracks, the measures and the time signature you wish to copy.
2. Follow the procedure in "Create a complete new rhythm: preparation" to prepare the **COMPOSER** memory you will be copying to. (Refer to pages 88 and 89.)
 - Be sure that time signature setting in the **SEQUENCER** data you are copying from and the time signature in the **COMPOSER** memory you are copying to are the same, or the data will not be copied successfully.
3. On the **COMPOSER RECORD** menu display, select **SEQ TO COMP COPY**.
 - The display looks similar to the following.

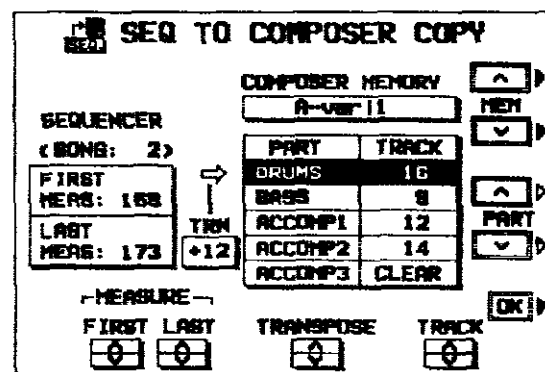

4. Use the **MEASURE FIRST** \wedge and \vee buttons to specify the number of the first measure to copy.

5. Use the MEASURE LAST \wedge and \vee buttons to specify the number of the last measure to copy.
 - Up to 8 measures can be copied.
6. Use the TRANSPOSE \wedge and \vee buttons to change the key of the copied measures (-12 to +12).
 - Units are in semitones.
7. Use the MEM \wedge and \vee buttons to specify the **COMPOSER** memory to copy to.
8. For each **COMPOSER** part, specify the **SEQUENCER** track from which to copy data.
 - Use the PART \wedge and \vee buttons to specify the part name, and the TRACK \wedge and \vee buttons to specify the track number.
 - Parts which are set to CLEAR are blank.
9. Press the OK button.
 - "COPY COMPLETED!" is shown on the display.
 - If you wish to edit the pattern you copied, follow steps 1, 2 and 10 of "Create a completely new rhythm: preparation," and then follow the recording procedure.

Record your rhythm pattern

Store each part of the rhythm pattern as you perform it on the keyboard.

Recording procedure

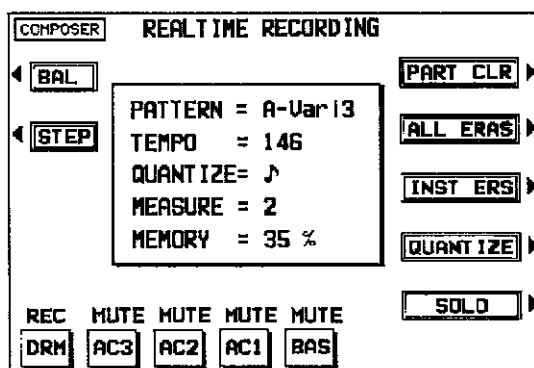

1. Adjust the tempo.
 - The tempo can be freely adjusted when you play back the rhythm pattern, so record at the tempo which is easiest for you to play.
2. Select the sound.
 - For the DRM part, select sounds from the **KEYBOARD PERC** sound group.
 - For the AC1, AC2, AC3 and BAS parts, select sounds from groups other than the **KEYBOARD PERC** sound group.
3. Record the part.
4. When you have finished recording one part, use the buttons below the display to select the next part to record.
5. Repeat steps 1 through 4 to record all the parts of the rhythm.
6. When you have finished recording the rhythm, press the **RECORD** button in the **COMPOSER** section to turn it off.
 - If you wish to continue creating other patterns, press the **EXIT** button to go back to the pattern selection display.



■ The display during recording

BAL

If you wish to adjust the volume of each part during recording, press the BAL button. The PART BALANCE display appears. Adjust the volume of each part.

- If you press the EXIT button, the display returns to the previous display.
- These settings are not stored.

STEP

When you press this button, the display changes to the STEP RECORD display, on which you can store the notes one by one. (Refer to page 93.)

PART CLR

Press this button if you wish to erase all recorded contents of the currently selected part.

ALL ERAS

The performance recorded in the selected part is erased for as long as this button is pressed.

INST ERS

When the DRM part is selected, the DRM part can be cleared instrument by instrument. Hold down this button and specify the instrument sound to be deleted by pressing the corresponding instrument key on the keyboard, after which only the specified instrument will be erased for as long as this button is kept pressed.

QUANTIZE

Set the desired quantize level to smooth out any unevenness in the timing of your performance. Each time this button is pressed, the indicated level changes. The quantize level is shown in the center of the display as "QUANTIZE=". Select from ♩3, ♪, ♩3, OFF, ♪, ♩3, ♪, ♩. (A 3 denotes a triplet-type note.)

SOLO

When you press this button while you are recording, only the part which is currently being recorded is played back. When SOLO is on, a MUTE mark is shown above the other part names on the display.

- To turn off the SOLO function, press this button again.

Playback

1. In the COMPOSER section, press the MEMORY button to turn it on.

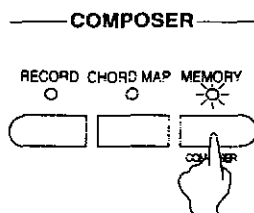

- The display looks similar to the following.

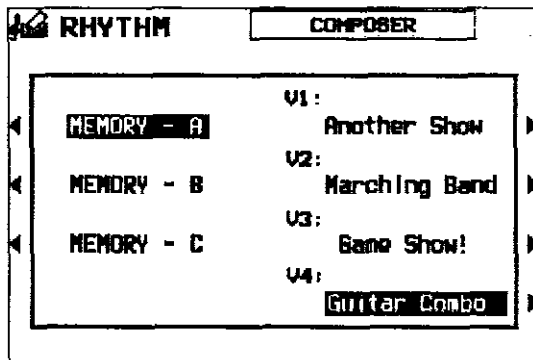

2. Use the buttons to the left of the display to select the memory (A, B or C) and the buttons to the right of the display to select the variation.

- The VARIATION & MSA buttons can also be used to select the variation.

3. Press the START/STOP button.

- The DRUMS part begins to play back.
- The BASS and ACCOMP parts are played back when you use the AUTO PLAY CHORD.

Step Record

Use STEP RECORD to store the notes one-by-one on the display. This is a convenient way to store complicated patterns that are difficult to play.

Recording procedure

1. While you are recording, press the STEP button.
- The display changes to the STEP RECORD display similar to the following.

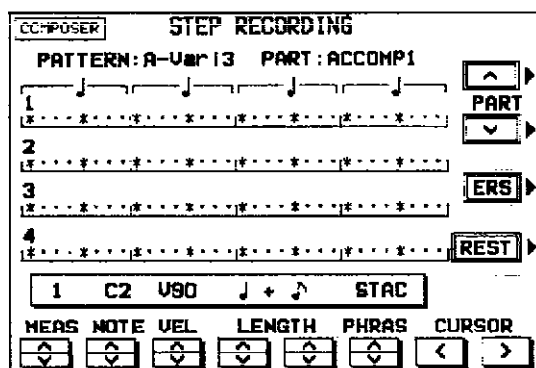

2. Use the MEAS buttons to select the measure you wish to record.
 - This step is not necessary if you are recording from measure 1 of a blank part.
3. Use the CURSOR < and > buttons to move the cursor to the note position (dot) you are going to store.
 - Each dot represents one-eighth of a quarter-note (a thirty-second note).
 - When storing triplets, it may not be possible to match the timing exactly with the 1/32-note steps. However, if you select triplet-type notes for the note length (LENGTH) in step 4 below, the timing is automatically corrected.
4. Use the left LENGTH buttons to specify the note value. Select from $\frac{3}{8}$, $\frac{1}{4}$, $\frac{1}{8}$, $\frac{1}{16}$, $\frac{1}{32}$, $\frac{1}{64}$, $\frac{1}{128}$, $\frac{1}{256}$, $\times 2$ to 4. (A 3 denotes a triplet-type note.)
 - For note values other than these, use the right LENGTH buttons to specify the note value to be added to that which you specified with the left buttons.

Example: To record a dotted quarter-note (.)



5. Use the PHRAS ^ and v buttons to specify the actual length of the produced sound for the desired legato or staccato effect.

TENU (tenuto):	Sound is produced for 95% of the note length.
NORM (normal):	80%
STAC (staccato):	50%
CUTT (cutting):	25%

6. Specify the pitch and velocity of the note by playing the keyboard.
 - The dot on the display where the note is stored changes to a * mark.
 - When recording chords, you can store multiple notes at one position.

REST: To store a rest, after specifying the note LENGTH, press the REST button.

- Positions at which nothing is stored are read as rests.

ERS: If you make a mistake, move the cursor to the error, and after displaying the data you wish to erase, press the ERS button.

7. Repeat steps 3 through 6 to continue storing notes.

- To record a different part, use the PART ^ and v buttons to select another part.
- You can easily switch between the REALTIME mode and the STEP mode any time during recording. To return to the realtime recording display during the STEP RECORD mode, press the EXIT button.

■ **Correcting the data**

1. In the STEP RECORD mode, specify the part you wish to correct.
2. Use the MEAS buttons to go to the measure you wish to modify. Use the CURSOR buttons to move the cursor to the point (*) you wish to edit.
 - The data stored at that point is shown on the display.
 - When a chord is stored at one point, a different note of the chord is displayed in order each time a CURSOR button is pressed.

3. Correct the data.

- NOTE data (note pitch) and VEL data (how hard the key was played), etc. are displayed. Use the relevant buttons to correct the data as desired.
- Press the ERS button to erase the data which is displayed.
- You can also correct data which was stored in the REALTIME RECORD mode.

Composer mode

Two playback modes are available for you to choose from. If you wish to use the intro, fill-in and ending patterns from a preset rhythm when you play back your new rhythm pattern, select NORMAL MODE. For creating and playing back your original intro, fill-in and ending patterns, select EXPAND MODE.

1. On the COMPOSER RECORD menu display, select MODE SELECT.
 - The display changes to the following.

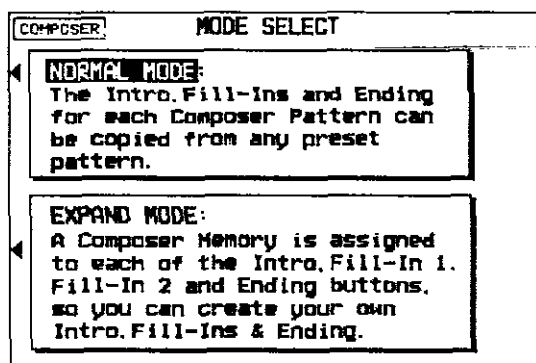

2. Select the mode.

■ **NORMAL MODE**

When a FILL IN button or an INTRO & ENDING button is pressed during playback, the corresponding pattern for a preset rhythm is played back. The rhythm which is played back is the one you specified for FILL IN SELECT on the RECORD SETTING display. (Refer to page 89.)

■ **EXPAND MODE**

When a FILL IN button or an INTRO & ENDING button is pressed during playback, the corresponding pattern you created is played back.

- Only one each FILL IN 1, FILL IN 2, INTRO 1, INTRO 2, ENDING 1 and ENDING 2 pattern can be created for each of the three banks (MEMORY A, MEMORY B or MEMORY C). The fill-in patterns, etc. for each bank are used for all the basic rhythms in the same bank.
- Each pattern of a memory should have the same time signature.

<MEMORY A>



<MEMORY B>

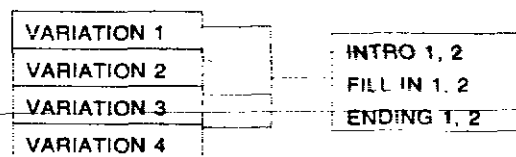

<MEMORY C>

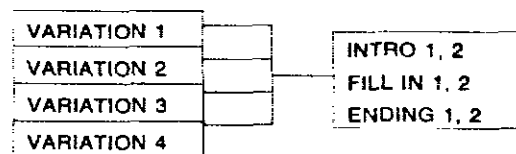

Composer Chord Map

A different accompaniment pattern can be selected for each of the four types of chords (major, minor, seventh and diminished). Then the accompaniment combination can be stored in one of five different maps.

- Store beforehand in a **COMPOSER** memory each accompaniment pattern you are going to perform when a type of chord is selected. When recording a pattern, for the minor type for example, record it in a minor key.

1. Press the **CHORD MAP** button in the **COMPOSER** section to turn it on.

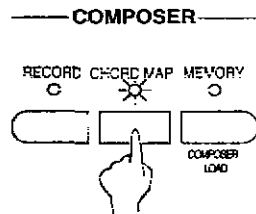

- The display looks similar to the following.

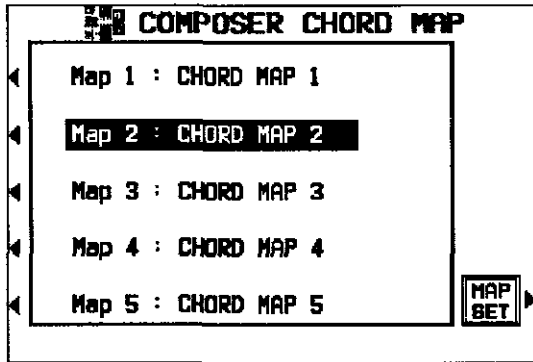

2. Press the **MAP SET** button.

- The display looks similar to the following.

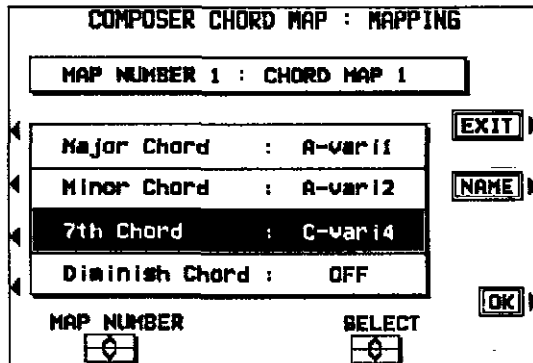

3. Use the **MAP NUMBER** \wedge and \vee buttons to select a map number (1 to 5).

4. Use the buttons to the left of the display to select a chord type.

5. Use the **SELECT** \wedge and \vee buttons to select a pattern for the chord type.

- Only patterns with the same number of measures and same time signature can be selected.
- The accompaniment pattern for the **INTRO**, **FILL IN** and **ENDING** is the one selected for Major.
- The accompaniment pattern for chords which are set to **OFF** is the same as the pattern for Major chords.

6. Repeat steps 4 and 5 for each chord type, as desired.

7. Press the **NAME** button.

- The display looks similar to the following.

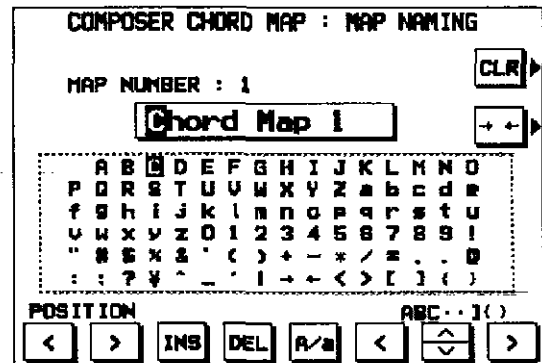

8. Assign a name to the map.

- Use the **POSITION** $<$ and $>$ buttons to highlight the character position in the name box. Use the **ABC..]({)** buttons to select the alphanumeric character. Repeat these steps to type the whole name.
- Use the **INS** button to type a space.
- Use the **DEL** button to erase a character.
- Use the **A/a** button to switch between upper case and lower case characters.
- To erase all the characters, press the **CLR** button.
- You can press the $\rightarrow \leftarrow$ button if you wish to have the name centered.

(continued on the next page)

9. Press the **EXIT** button.
 - The display returns to the previous display.
 10. Repeat steps 3 to 9 to create other maps, as desired.
 11. Press the OK button.
 12. When you have finished making the MAP SET settings, press the EXIT button.
-

Recall chord map

Follow the procedure below to recall a stored chord map and use with your performance.

1. Press the **CHORD MAP** button in the **COMPOSER** section to turn it on.
2. Use the buttons to the left of the display to select the number of the desired map.
 - After a few seconds, the display returns to the previous display.
3. Play the keyboard using the automatic accompaniment.
 - The pattern changes according to the type of chord you play.
 - If you wish to end a performance which uses a **COMPOSER CHORD MAP**, select a different rhythm from the **RHYTHM GROUP**.

Part V Disk Drive

Outline of the Disk Drive function

The Disk Drive enables you to store **COMPOSER** memories, **SEQUENCER** data etc. for future use.

Internal memory and Floppy Disk Drive

The storable internal memory is fixed at a limited capacity, but this external memory device expands the storable memory infinitely.

- You can use 3.5 inch 2DD (720 KB) or 2HD (1.44 MB) floppy disks; however, 2HD disks formatted as 2DD cannot be used.
- Specific file formats are handled as follows.

		SAVE	LOAD
TECHNICS File		○	○
Standard MIDI File	FORMAT 0	○	○
	FORMAT 1	×	○

FORMAT 0: There is one track on the disk, and it contains the 16 MIDI channels.

FORMAT 1: There is an unlimited number of tracks on the disk, each of which can contain the 16 MIDI channels.

Floppy Disk Drive

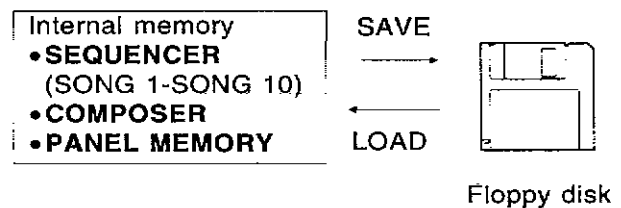
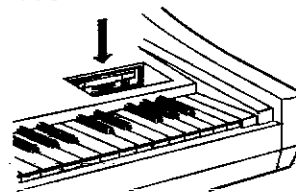

- **SEQUENCER** data is saved and loaded one song at a time.

Loading commercial software

Disks recorded using the Disk Drive of this instrument can, of course, be played back on your instrument (TECHNICS file). But this instrument also reads song data from floppy disks recorded in the Standard MIDI File format, enabling you to play commercial song disks on this instrument. In addition, by saving this instrument's **SEQUENCER** data in the Standard MIDI File format, you can play it back on an external sequencer.

DIRECT PLAY

You can play commercially sold song disks immediately without performing the normal load procedure.

- **DIRECT PLAY** can be used for the following disks:

Standard MIDI File (SMF) disks (FORMAT 0)

DISK ORCHESTRA COLLECTION™ (DOC) PianoDisc™

* **DISK ORCHESTRA COLLECTION** is a trademark of the **YAMAHA Corporation**.

* **PianoDisc** is a registered trademark of Music Systems Research.

■ About Standard MIDI Files

"Standard MIDI File" is a standardized data format which makes it possible for music data to be exchanged among different sequencers. Data stored in this format on sequencers of different models can be played back on this instrument, and vice versa.

- Only files with the ".MID" extension can be loaded.
- No more than 310 KB of data can be loaded into this instrument.

Warning:

Standard MIDI Files ensure the compatibility of data such as key on, key off, velocity, program number. It does not guarantee 100% faithful reproduction of recorded music which is replete with such data. For exact playback of music, it may be necessary to perform extensive adjustments of all the sound generator settings. As you the listener are the ultimate judge of what sounds best, you should perform such adjustments to your satisfaction.

Main parts of the Floppy Disk Drive

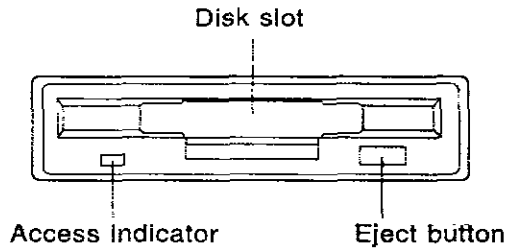

Eject button

Press to remove the disk from the Disk Drive.

Access Indicator

Lights when data is being loaded from or saved to disk.

- To prevent data loss, do not remove the disk from the Disk Drive or turn off the power when the access indicator is lit.

Outline of procedure

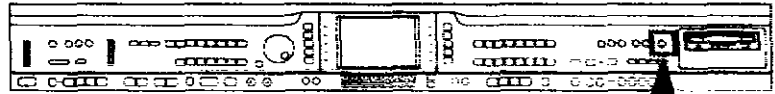

1. Press the **MEMORY & CONTROL** button to turn it on.

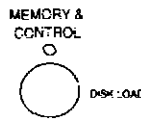

- The display changes to the following.

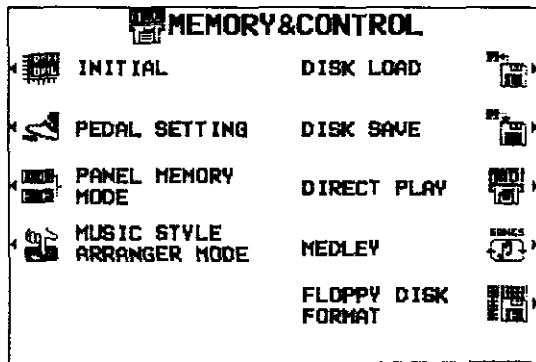

DISK LOAD (page 99)

Load data in either the Technics File format or Standard MIDI File format from a disk into this instrument's memory.

DISK SAVE (page 103)

Save data from this instrument's memory to a disk, in either the Technics File format or the Standard MIDI File format.

DIRECT PLAY (page 101)

Immediate playback of commercial song disks.

FLOPPY DISK FORMAT (page 102)

Format new floppy disks or erase the contents of recorded disks so they can be used by this instrument.

- MEDLEY is explained on page 83.
- INITIAL is explained on page 127.
- PEDAL SETTING is explained on page 53.
- PANEL MEMORY MODE is explained on page 52.
- MUSIC STYLE ARRANGER MODE is explained on page 51.

2. Select the desired menu and follow the procedures on the corresponding setting display.

- When the **TEMPO/PROGRAM** indicator is lit, it indicates that the dial is available for setting the current function.

3. When you have finished setting the functions, press the **MEMORY & CONTROL** button to turn it off.

Loading data

Recall (load) the data from the disk to this instrument's memories.

WARNING: The load procedure causes any data which is currently stored in the relevant memories to be erased.

DISK LOAD

1. Insert the floppy disk into the Disk Drive. Push it all the way in until you hear a click.

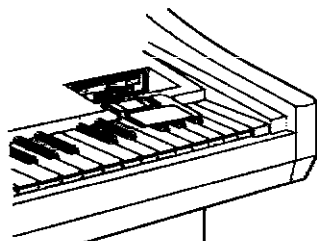

2. On the **MEMORY & CONTROL** menu display, select **DISK LOAD**.

- The display looks similar to the following.

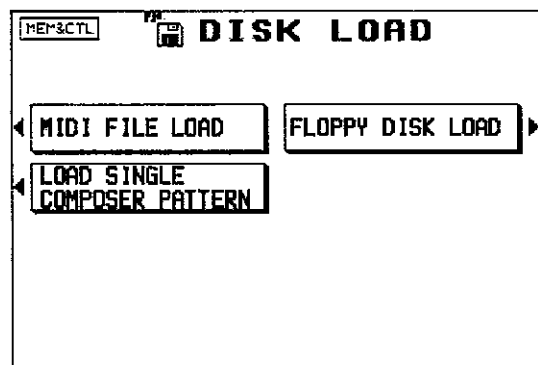

3. Select the type of data load you want.

FLOPPY DISK LOAD

Load data which was saved in the Technics File format.

MIDI FILE LOAD

Load data which was saved in the Standard MIDI File format.

LOAD SINGLE COMPOSER PATTERN

Load **COMPOSER** data from a disk into a specified memory number.

4. Perform the selected disk load procedure. (Refer to the following sections.)

■ FLOPPY DISK LOAD

Load data which was saved in the Technics File format.

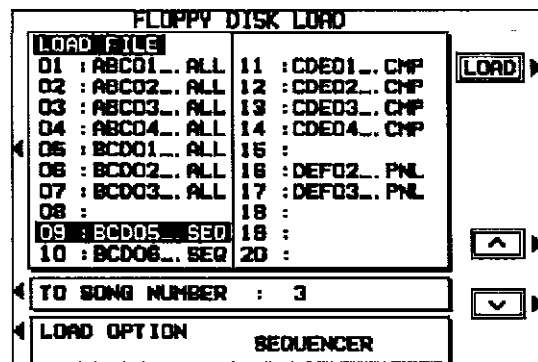

1. Select the **LOAD FILE** box. Use the \wedge and \vee buttons to select the file on the floppy disk you wish to load (copy) to this instrument's memories.

- The file name is shown next to each file number.

2. Select the **TO SONG NUMBER** box. Use the \wedge and \vee buttons to select the song number in this instrument's memories to which you wish to have the file loaded (copied).

- **SEQUENCER** data is loaded one song at a time. However, if you load a file for which the **SAVE OPTION** was set to **ALL**, **SEQUENCER** songs 1 to 10 are loaded at once.

(continued on the next page)

3. Select the LOAD OPTION box. Use the \wedge and \vee buttons to specify the kind of data you wish to load from the disk to your instrument.

ALL: All the following data is loaded.
 SEQUENCER: Only **SEQUENCER** data
 COMPOSER: Only **COMPOSER** data
 PANEL MEMORY: Only **PANEL MEMORY** data

- The option which was specified during the SAVE procedure is automatically selected. Skip this step if you do not wish to change the selection.

4. Press the LOAD button.

- The LOAD operation begins.
- When the operation has been successfully completed, "COMPLETED!" is shown on the display.
- If song data was loaded, you can press the **START/STOP** button to begin playback when the **SEQUENCER PLAY** display is active.

- You can quickly load just the **COMPOSER** data by pressing and holding the **COMPOSER LOAD (MEMORY)** button for a few seconds.
- You can also access the **DISK LOAD** display by pressing the **MEMORY & CONTROL (DISK LOAD)** button for a few seconds.

■ MIDI FILE LOAD

Load data which was saved in the Standard MIDI File (SMF) format.

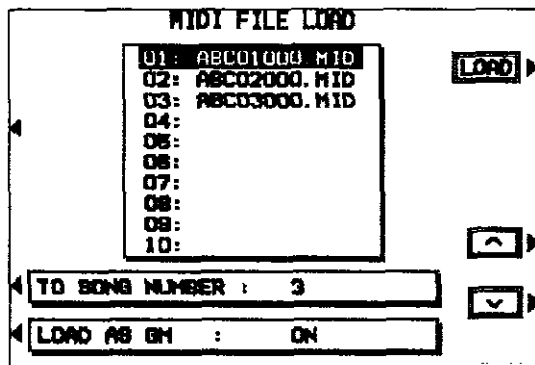

1. Select the file list box. Use the \wedge and \vee buttons to select the file.

2. Select the TO SONG NUMBER box. Use the \wedge and \vee buttons to select the song.
- Data is loaded one song at a time.

3. Select the LOAD AS GM box, and use the \wedge and \vee buttons to specify whether or not to load the song as GENERAL MIDI (GM) (ON/OFF).

- If the GM setting you specify is different from the setting in the file, the sounds, the octave, and the arrangement of percussion sounds on the keyboard will be different.
- Information about GENERAL MIDI can be found on page 119.
- If playback is executed with the setting set to ON, the functions of this instrument are limited in various ways. For detailed information, please refer to the separate REFERENCE GUIDE provided.

4. Press the LOAD button.

- The LOAD operation begins.
- When the operation has been successfully completed, "COMPLETED!" is shown on the display.
- Press the **START/STOP** button to begin playback.

■ LOAD SINGLE COMPOSER PATTERN

Load the desired **COMPOSER** data from a disk into a specific **COMPOSER** memory.

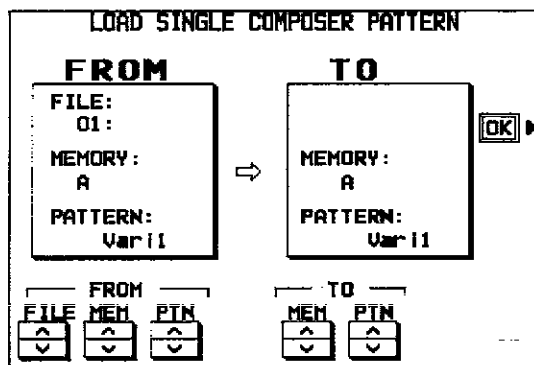

1. Select the data to load (FROM).

FILE: Specify the file number to load.

MEM: Select the memory bank (A, B or C).

PTN: Select the pattern name.

2. Select the memory bank and pattern to load to (TO).

MEM: Select the memory bank (A, B or C).

PTN: Specify the pattern name.

3. Press the OK button.
 - The LOAD operation begins.
 - When the operation has been successfully completed, "COMPLETED!" is shown on the display.
 - This procedure can also be accessed from the **COMPOSER RECORD** menu display. (Refer to page 85.)

Playing commercial disks

Commercial song disks can be played back directly from a disk. The usual LOAD operation is not necessary, so playback is quicker.

DIRECT PLAY

1. Insert the disk you wish to play back into the Disk Drive.
2. On the **MEMORY & CONTROL** menu display, select **DIRECT PLAY**.
 - The display looks similar to the following.

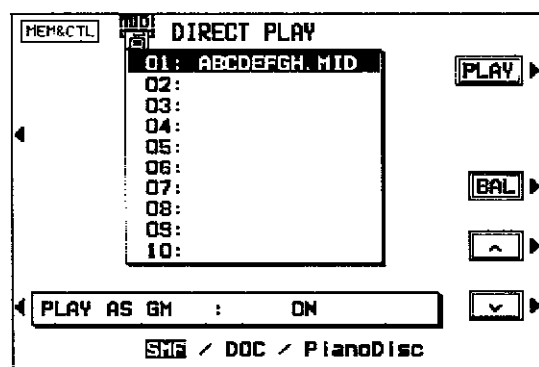

3. Select the song list box, and use the ^ and v buttons to select the filename to play back.

4. Select the **PLAY AS GM** box, and use the ^ and v buttons to specify whether or not to play the song as **GENERAL MIDI (GM)** (ON/OFF).
 - If the GM setting you specify is different from the setting in the file, the sounds, the octave, and the arrangement of percussion sounds on the keyboard will be different.
 - Information about **GENERAL MIDI** can be found on page 119.
 - If playback is executed with the setting set to ON, the functions of this instrument are limited in various ways. For detailed information, please refer to the separate **REFERENCE GUIDE** provided.
 - **DIRECT PLAY** can be used for the following disks:
 - Standard MIDI File (SMF) disks (FORMAT 0)
 - DISK ORCHESTRA COLLECTION™ (DOC)
 - PianoDisc™
 - * DISK ORCHESTRA COLLECTION is a trademark of the YAMAHA Corporation.
 - * PianoDisc is a registered trademark of Music Systems Research.
 - **DIRECT PLAY** from Standard MIDI File **FORMAT 1** disks is not possible. To play **FORMAT 1** disks, follow the **MIDI FILE LOAD** procedure. (Refer to page 100.)

(continued on the next page)

5. Press the PLAY button.
 - The selected song begins to play.
 - To adjust the volume balance, press the BAL button and change the settings on the BALANCE display.
 - The PLAY button becomes the STOP button. Press this button if you wish to stop playback before it has finished.
 - You can use the same procedure to play back other songs on the disk.
- The song stops if you exit this display during playback.

Formatting a disk

New floppy disks can be used only after they have been formatted. Follow the procedure below to format a new disk or erase the contents of a recorded disk.

FLOPPY DISK FORMAT

- This procedure clears the entire contents of the disk.
- Reformat a disk if it cannot be saved to or loaded from properly because of exposure to a magnetic field.
- You can use 3.5 inch 2DD (720KB) or 2HD (1.44MB) floppy disks.
- Be sure to specify the type of format which is suitable for the disk.
- How to distinguish the two disk types:

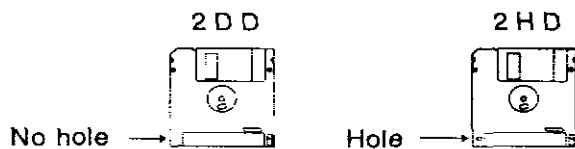

- Although 2HD floppy disks can hold more data and are convenient for quick loading and saving, 2DD disks are generally used for musical instruments. Therefore, you may not be able to use your 2HD disk data with other musical instrument models.
- To format the floppy disk, the write-protect window must be closed, as illustrated.

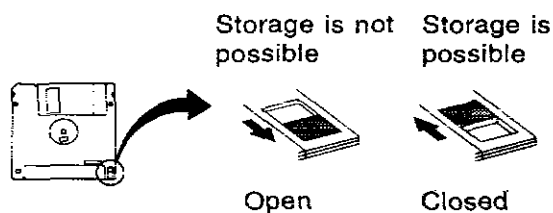

1. Insert the floppy disk into the Disk Drive slot. Push it all the way in until you hear a click.
2. On the **MEMORY & CONTROL** menu display, select **FLOPPY DISK FORMAT**.
 - The display changes to the following.

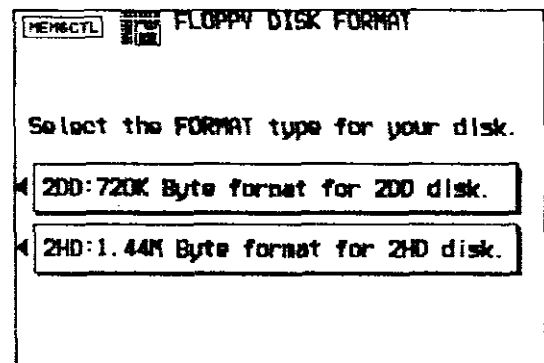

3. Select the type of format (2DD or 2HD).
 - Be sure to select the type which is the same as your disk type.
 - The display changes to the following.

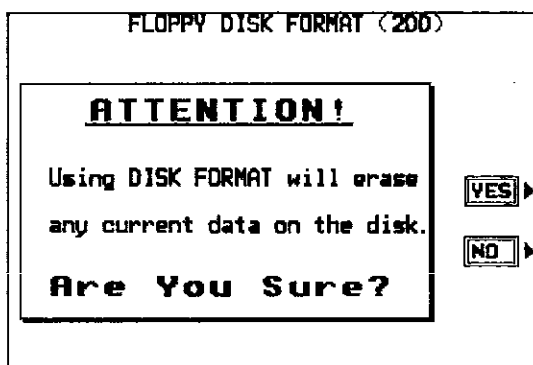

4. Press the YES button to format the disk, or press the NO button to cancel the format.
 - After about 1–2 minutes, formatting is completed and "FORMAT COMPLETED!" is shown on the display.

Saving data

The recorded data and panel settings of this instrument can be saved on a disk.

- It is a good idea to save Technics File format data and Standard MIDI File format data in separate disks.

DISK SAVE

This procedure is used to save the performance data and settings of this instrument to a disk.

1. Insert a formatted disk into the Disk Drive slot. Push it all the way in until you hear a click.
2. On the **MEMORY & CONTROL** menu display, select **DISK SAVE**.
 - The display looks similar to the following.

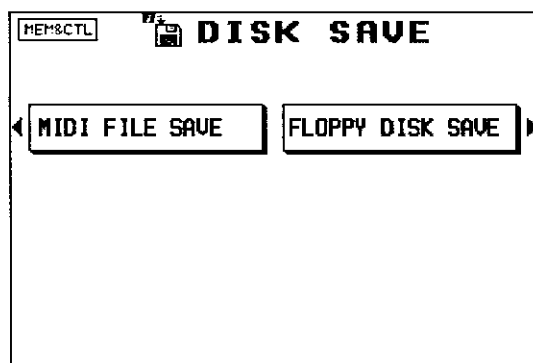

3. Select the type of data save you want.

FLOPPY DISK SAVE

Save data in the Technics File format.

MIDI FILE SAVE

Save data in the Standard MIDI File format.

4. Perform the selected disk save procedure. (Refer to the following sections.)

FLOPPY DISK SAVE

Save data from this instrument in the Technics File format to a floppy disk.

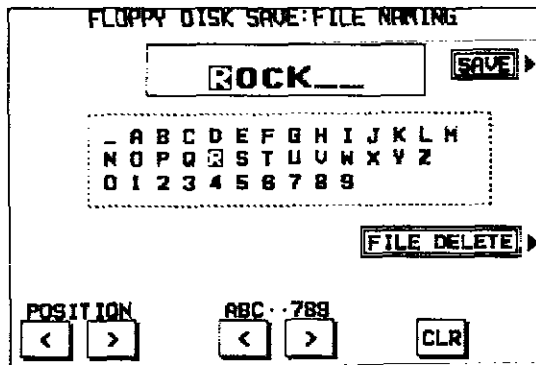

- Type a name for the new data file (up to 6 characters).
 - Use the POSITION < and > buttons to highlight the character position. Use the ABC 789 < and > buttons to select the alphanumeric character. Repeat these steps to type the whole name.
 - To erase the name, press the CLR button.
- Press the SAVE button.
 - The display looks similar to the following.

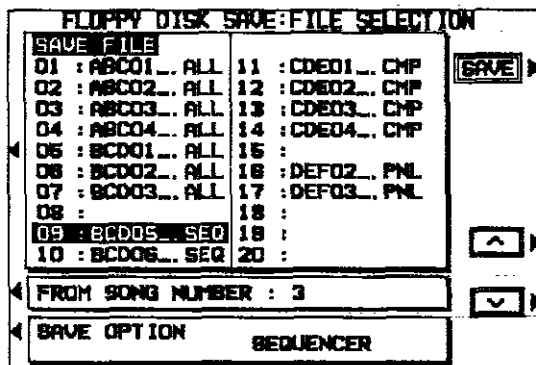

- Select the SAVE FILE box. Use the ^ and v buttons to select a file number (01 to 20).
 - Files in which data is currently stored are indicated by the file name following the file number.
 - The maximum number of files which can be saved may be less than 20 if you are saving many songs which use a lot of memory.
 - For effective use of disk memory, if it is not necessary to save the COMPOSER data, clear the COMPOSER memories before saving to disk.
 - More data can be saved by using a 2HD floppy disk.

- Select the FROM SONG NUMBER box. Use the ^ and v buttons to select the song number in this instrument's memories you wish to have saved to the floppy disk.
 - SEQUENCER data is saved one song at a time. However, if ALL is selected for the SAVE OPTION, SEQUENCER songs 1 to 10 are saved at once. In this case, you can conserve memory by deleting songs you do not wish to save.
- Select the SAVE OPTION box. Use the ^ and v buttons to specify the kind of data you wish to save to the disk.

ALL: All the following data is saved.
 SEQUENCER: Only SEQUENCER data
 COMPOSER: Only COMPOSER data
 PANEL MEMORY: Only PANEL MEMORY data

- The MASTER TUNING setting is not saved.
- Press the SAVE button.
 - The SAVE operation begins.
 - When the operation has been successfully completed, "COMPLETED!" is shown on the display.
 - If you attempt to save data to a file number in which data is currently saved, the display changes to the confirmation display. Press the NO button if you wish to cancel the procedure. When the YES button is pressed, the DISK SAVE operation begins.

FILE delete

To erase a song from a disk, on the FILE NAMING display, press the FILE DELETE button. Then on the FLOPPY DISK SAVE display, select the number of the song you wish to erase, and press the DEL button. The display changes to the confirmation display. Press the YES button to erase the song, or press the NO button to cancel the procedure.

■ MIDI FILE SAVE

The data from this instrument's **SEQUENCER** can be saved to a floppy disk as Standard MIDI Files (SMF) (FORMAT 0 only). (Standard MIDI Files are most commonly saved on 2DD floppy disks.) Data saved on this instrument can then be used on another instrument.

- What you can save in the Standard MIDI File format is ordinary performance data, such as note data. Data such as **SEQUENCER** data for the chord and rhythm parts, **COMPOSER** data, **PANEL MEMORY** data, etc. is not saved. If you wish to also save the special Technics data, first use the DISK SAVE procedure to save the data to a disk, and then follow the MIDI FILE SAVE below.
- Standard MIDI Files are generally saved in the GM mode, but can be saved in the Technics mode.

1. Type a name for the new data file (up to 8 characters).
 - Use the POSITION < and > buttons to highlight the character position. Use the ABC 789 < and > buttons to select the alphanumeric character. Repeat these steps to type the whole name.
 - To erase the name, press the CLR button.
 - Avoid using the numbers from 01 to 20 as the first two letters of the name.

2. Press the SAVE button.

- The display looks similar to the following.

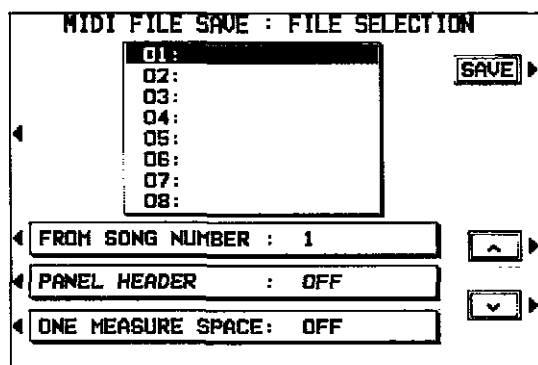

3. Select the file list box. Use the ^ and v buttons to select the name of the file in which to save the data.
 - To save in a new file, select a blank line.
4. Select the FROM SONG NUMBER box. Use the ^ and v buttons to select the song number in this instrument's memories you wish to have saved to the floppy disk.
 - Data is saved one song at a time.

5. Select the PANEL HEADER box, and use the ^ and v buttons to select ON or OFF.

- Select ON to save the sound, volume and other settings for each part as data at the beginning of the file.
6. Select the ONE MEASURE SPACE box, and use the ^ and v buttons to select ON or OFF.
 - When there is various data other than performance data stored at the beginning of a file, the start of playback may be delayed. This can be avoided by inserting a one-measure space before the beginning of the performance. Select ON to insert a one-measure space. Select OFF if you do not wish to insert the space.
 - When set to ON, a space is added each time a file is saved. Therefore, if you have already saved a file once with the ONE MEASURE SPACE set to ON, please set it to OFF each time the file is subsequently saved.

7. Press the SAVE button.

- The SAVE operation begins.
- When the operation has been successfully completed, "COMPLETED!" is shown on the display.
- If you attempt to save data to a file number in which data is currently saved, the display changes to the confirmation display. Press the NO button if you wish to cancel the procedure.

FILE delete

To erase a song from a disk, on the MIDI FILE NAMING display, press the FILE DELETE button. Then on the MIDI FILE SAVE display, select the number of the song you wish to erase, and press the DEL button. The display changes to the confirmation display. Press the YES button to erase the song, or press the NO button to cancel the procedure.

Part VI Adjusting the sounds

Sound mode

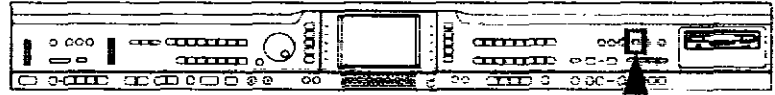

The **SOUND** mode is used for making fine adjustments to the functions related to sound, such as tone, volume and effects.

SOUND menu

1. Press the **SOUND SETTING** button to turn it on.



- The display changes to the following.

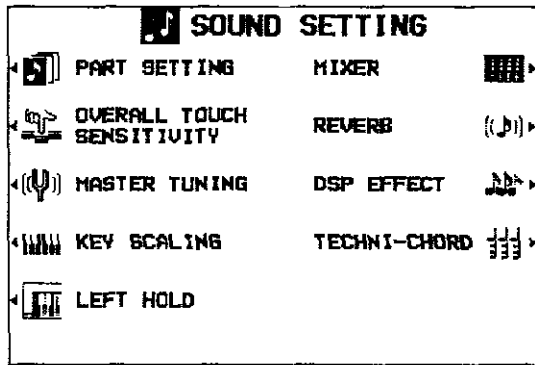

2. Select the desired menu and follow the procedures on the corresponding setting display.
 - When the current display is a setting display, you can press the **EXIT** button to go back to the previous display. To show other menus, use the **EXIT** button to return to the **SOUND** menu display and make another selection.
 - When the **TEMPO/PROGRAM** indicator is lit, it indicates that the dial is available for setting the current function.

3. When you have finished setting the functions, press the **SOUND SETTING** button to turn it off.

■ A word about parts

The organization of the sound parts is as follows.
Normal parts:

RIGHT 1, RIGHT 2, LEFT, PART 4 to 16
(PART 16 is reserved for the DRUMS part)

AUTO PLAY CHORD parts:

ACCOMP 1, 2, 3, BASS, DRUMS, CHORD,
R. BASS

Summary of the SOUND menu items

PART SETTING (page 107)

Set the various sound attributes for each part.

VOLUME: Adjust the volume for each part.

PAN: Adjust the stereo balance of each part.

EFFECT: Adjust the effects for each part.

SUSTAIN: Adjust the length of the sustain for each part.

KEY SHIFT: Adjust the key of each part in semitone increments.

TUNING: Fine-tune the pitch of each part.

PITCH BEND RANGE: Set the amount of pitch change when MIDI pitch bend data is received.

OTHER SETTING: Additional settings for each part.

MIXER (page 112)

Use the MIXER display to visually adjust the major settings of each part.

OVERALL TOUCH SENSITIVITY (page 113)

Adjust the amount of keyboard touch response.

MASTER TUNING (page 113)

Select the type of tuning for the instrument.

KEY SCALING (page 114)

Select the type of scaling (tuning).

TECHNI-CHORD TYPE (page 115)

Select the **TECHNI-CHORD** harmony style.

LEFT HOLD (page 116)

Set the mode which determines how the **LEFT** part sounds during an **AUTO PLAY CHORD** performance.

REVERB (page 117)

Select the type and depth of the **DIGITAL REVERB**.

DSP EFFECT (page 117)

Select the type and degree of the **DSP EFFECT**.

Part Setting

Set the various sound attributes for each part.

Selecting an attribute

1. On the **SOUND** menu display, select **PART SETTING**.

- The display looks similar to the following.

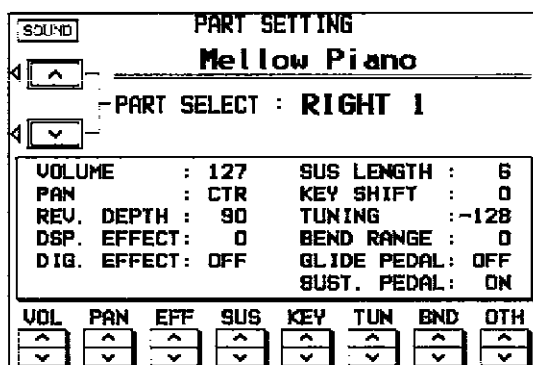

2. Use the \wedge and \vee buttons to select the part.

- PART 4 to 16 are used in **SEQUENCER** and **MIDI** functions. PART 16 is reserved for the **DRUMS** part.
- For information concerning **CHORD** and **R.BASS**, refer to the section on the **AUTO PLAY CHORD** (page 46).
- If necessary, assign a sound to the selected part at this time. (Only sounds from the **KEYBOARD PERC** group can be selected for PART 16.)
- The upper portion of the display shows the name of the selected part and the sound assigned to that part. The box in the lower portion of the display shows the status of each attribute for the selected part.

3. Use the buttons along the bottom of the display to select the attribute you wish to adjust.

VOL: VOLUME

PAN: PAN

EFF: EFFECT

SUS: SUSTAIN

KEY: KEY SHIFT

TUN: TUNING

BND: PITCH BEND RANGE

OTH: OTHER SETTING

- The display changes to the setting display for the selected attribute.
- The settings which can be adjusted may differ depending on the selected part.

4. Adjust each attribute (explained in detail following).

- When you have completed adjustment of an attribute, use the buttons along the bottom of the display to select the next attribute you wish to adjust.

5. When you have completed adjusting all of the settings for one part, select another part and repeat the adjustment procedure as desired.

- The settings and effects of the **PAN**, **EFFECT** etc. may differ depending on the sound.



VOLUME

Adjust the volume of each part.

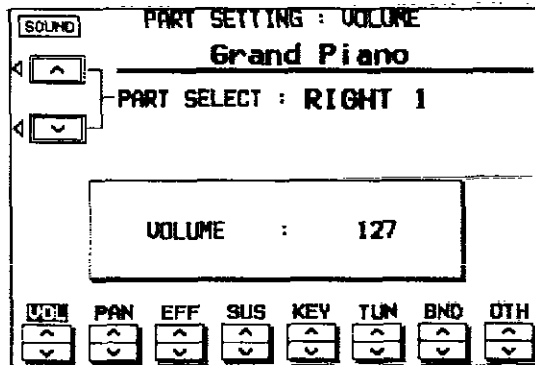

Use the VOL \wedge and \vee buttons to adjust the volume (0 to 127).

- If you wish to adjust this effect for other parts, use the PART SELECT \wedge and \vee buttons to select another part.

PAN

Adjust the stereo balance of each part.

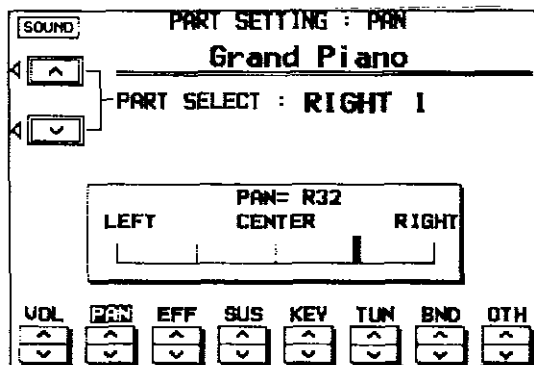

Use the PAN \wedge and \vee buttons to adjust the stereo balance (L64–CTR–R63).

- At L64, the sound is completely to the left, at R63 completely to the right. At CTR, the sound is at the center. A thick vertical line on the display indicates the selected position.
- If you wish to adjust this effect for other parts, use the PART SELECT \wedge and \vee buttons to select another part.
- Even at the same numerical value, the stereo balance may differ slightly depending on the sound.

EFFECT

The **DIGITAL REVERB** depth, the **DSP EFFECT** depth, and the **DIGITAL EFFECT** on/off status can be set for each part.

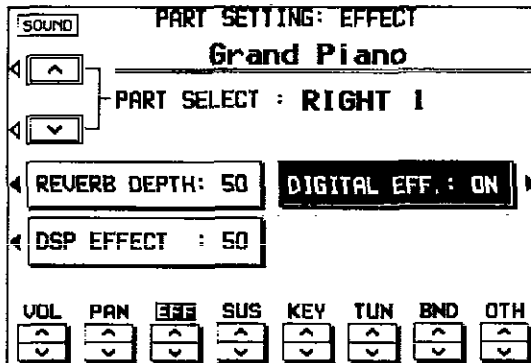

1. Select an effect (REVERB DEPTH, DSP EFFECT or DIGITAL EFF).
2. Use the EFF \wedge and \vee buttons to change the setting.
 - For the REVERB DEPTH and DSP EFFECT, specify the depth (0 to 127). For the DIGITAL EFF, set to ON or OFF.
 - If the **DSP EFFECT** button is pressed after the settings have been changed, the DSP EFFECT setting will revert to the preset value. For this reason, it is recommended that you use the **PANEL MEMORY** to store your customized DSP EFFECT setting.
3. Repeat steps 1 and 2 for the other effects, as necessary.
 - If you wish to adjust this effect for other parts, use the PART SELECT \wedge and \vee buttons to select another part.
 - Even at the same numerical value, the effect may differ depending on the sound.

SUSTAIN

Specify the length of the sustain for each part.

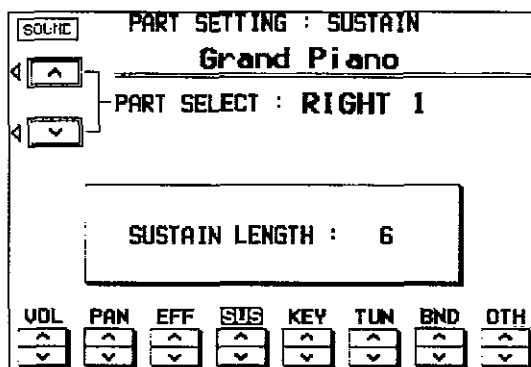

- Use the SUS \wedge and \vee buttons to adjust the length of the sustain (1 to 8).
 - For some sounds, the length of the sustain does not change even if the number is changed.
- If you wish to adjust this effect for other parts, use the PART SELECT \wedge and \vee buttons to select another part.

KEY SHIFT

The pitch of the part can be shifted up or down.

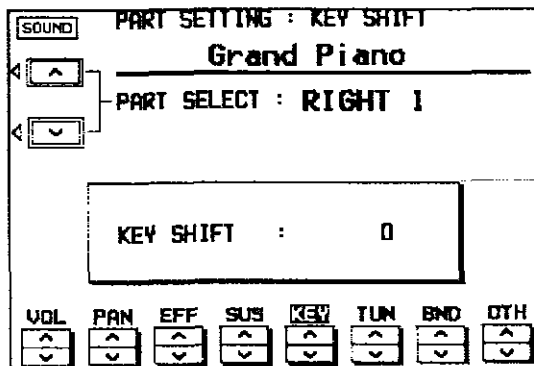

Use the KEY \wedge and \vee buttons to specify the amount of key shift (-12 to +12).

- A value of 1 means a shift of one semitone. To raise (or lower) the pitch one octave, set the value to +12 (or -12).
- The \vee button is used to lower the pitch, and the \wedge button to raise the pitch.
- If you wish to adjust this effect for other parts, use the PART SELECT \wedge and \vee buttons to select another part.

TUNING

Fine-tune the pitch of each part.

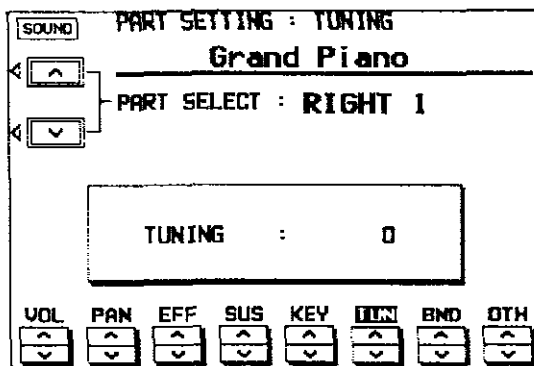

Use the TUN \wedge and \vee buttons to adjust the tuning (-128 to +127).

- The \vee button is used to lower the pitch, and the \wedge button to raise the pitch.
- If you wish to adjust this effect for other parts, use the PART SELECT \wedge and \vee buttons to select another part.

PITCH BEND RANGE

Set the amount of pitch change when MIDI pitch bend data is received.

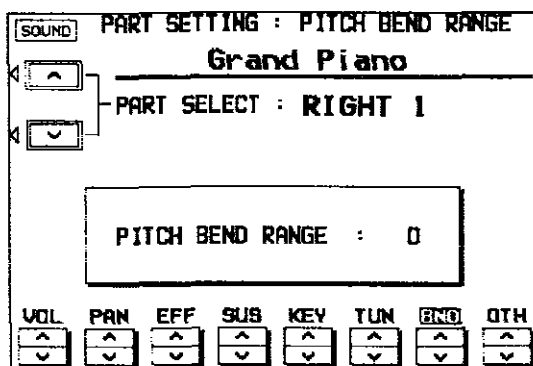

Use the BND \wedge and \vee buttons to specify the range (0 to 12). Increments are in semitones.

- The higher the number, the greater the change in pitch when MIDI pitch bend data is received.
- If you wish to adjust this effect for other parts, use the PART SELECT \wedge and \vee buttons to select another part.

OTHER SETTING

Modify the pedal setting and other settings.

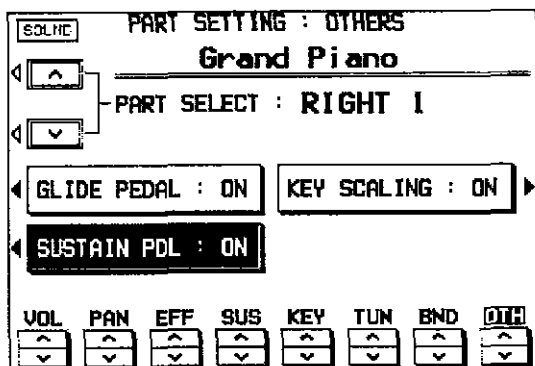

1. Select the function to adjust.

GLIDE PEDAL:

Enable or disable the glide effect, if it has been assigned to the soft pedal or sostenuto pedal.

SUSTAIN PDL:

Enable or disable the sustain effect, when the sustain pedal is pressed (**SUSTAIN PEDAL** button on/off).

KEY SCALING:

Enable or disable key scaling (page 114).

2. Use the OTH \wedge and \vee buttons to select ON or OFF for each function.

- For pedal settings, refer to page 53.
- To change the settings for other parts, use the PART SELECT \wedge and \vee buttons to select a different part.

Mixer

Use the MIXER display to visually adjust the major settings of each part. Use this display to make broad, general changes to the settings.

- On the **SOUND** menu display, select MIXER.
 - The MIXER display consists of 2 pages. Use the **PAGE** buttons to switch between the pages.
 - On each page you can press the **OTHER PARTS** button to switch to parts 9 to 16 (PT9–PT16).
- Adjust each parameter.

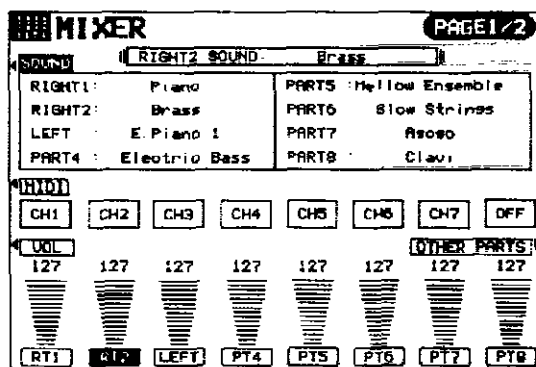

SOUND: Press the **SOUND** button. Use the balance buttons below the display to set the sound for the corresponding part.

- The buttons in the **SOUND GROUP** can also be used to select the sound.

MIDI: Press the **MIDI** button. Use the balance buttons below the display to set the MIDI basic channel for each part.

- Information about MIDI basic channels can be found on page 121.

VOLUME: Press the **VOL** button. Use the balance buttons below the display to adjust the volume of the corresponding part.

- To mute a part, press both the corresponding balance buttons as the same time. To cancel the mute, press either balance button for the part.

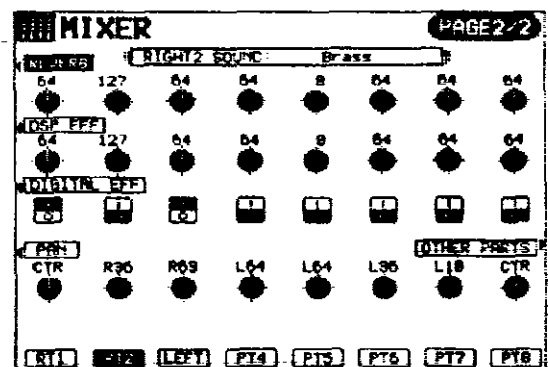

REVERB: Press the **REVERB** button. Use the balance buttons below the display to set the level of the **DIGITAL REVERB** for the corresponding part.

DSP EFFECT: Press the **DSP EFF** button. Use the balance buttons below the display to adjust the level of the **DSP EFFECT** for the corresponding part.

DIGITAL EFFECT: Press the **DIGITAL EFF** button. Use the balance buttons below the display to set the **DIGITAL EFFECT** to on (1) or off (0) for the corresponding part.

PAN: Press the **PAN** button. Use the balance buttons below the display to adjust the stereo balance of the corresponding part.

- Even at the same numerical value, the **PAN** and effects may differ depending on the sound.

Overall Touch Sensitivity

Select a keyboard touch response mode, and specify whether or not sound is generated when the keys are pressed very softly.

1. On the **SOUND** menu display, select **OVER-ALL TOUCH SENSITIVITY**.
 - The display changes to the following.

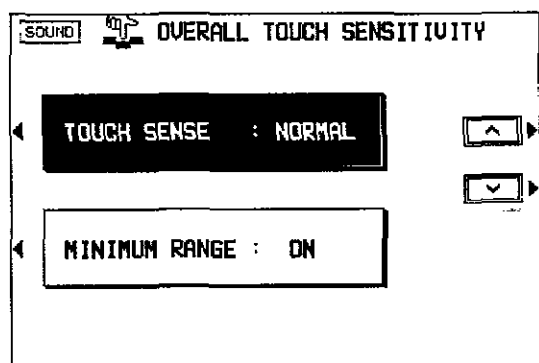

2. Select **TOUCH SENSE**.
3. Use the \wedge and \vee buttons to select the touch mode.
 - Select from **HEAVY 1, 2, NORMAL, LIGHT 1, 2**.
4. Select **MINIMUM RANGE**.
5. Use the \wedge and \vee buttons to select **ON** or **OFF**.
 - ON:** No sound is produced when the keys are pressed very softly (acoustic piano type).
 - OFF:** Sound is produced even when the keys are pressed very softly.

Master Tuning

This setting is used to fine-tune the pitch of the entire instrument. This is convenient when this instrument is played with other instruments or with a recorded performance.

1. On the **SOUND** menu display, select **MASTER TUNING**.
 - The display changes to the following.

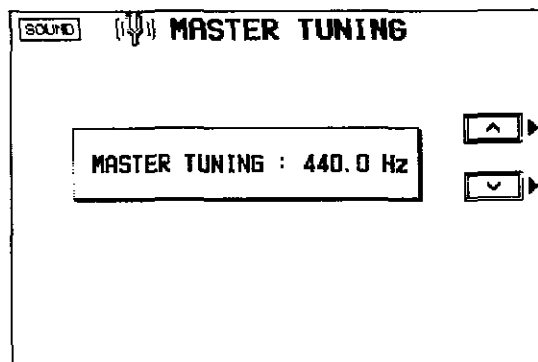

2. Use the \wedge and \vee buttons to adjust the pitch within a range of 427.3 to 453.0 Hz.
 - The decimal can be set to 0, 3 or 6.

Key Scaling

The temperament (tuning) of this instrument can be adjusted. Various types other than standard temperament are available to choose from.

1. On the **SOUND** menu, select **KEY SCALING**.
 - The display looks similar to the following.

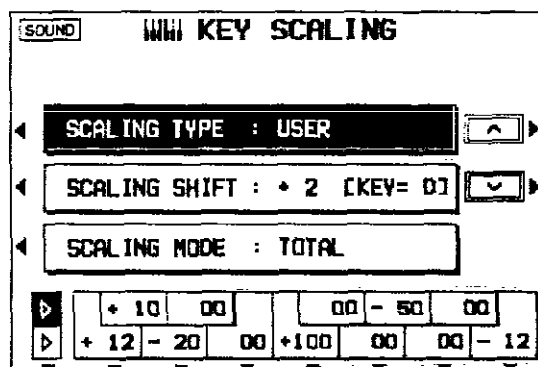

2. Select **SCALING TYPE**.
3. Use the \wedge and \vee buttons to select the type.
 - Select from **OFF**, **RANDOM**, **PIANO**, **ORCHESTRA**, **PYTHAGOREAN**, **WERCKMEISTER**, **KIRNBERGER**, **ARABIC 1 to 5**, **SLENDRO**, **PELOG**, **USER**.
 - **OFF** is equal temperament tuning.
 - Select **USER** if you wish to use a customized scaling (explained in the following section).
4. Select **SCALING SHIFT**.
5. Use the \wedge and \vee buttons to select the key in which you are going to perform.
 - These **KEY SCALING** settings can be set to on or off for each part. (Refer to page 111.)
6. Select **SCALING MODE**.
7. Use the \wedge and \vee buttons to select a scaling mode.

SOUND: The preset key scaling specified for individual sounds is active.

TOTAL: The key scaling selected for this instrument is active for all parts. (Select this mode if you are selecting a tuning type.)

■ User type scaling

You can adjust the instrument to a customized scaling.

- In **KEY SCALING**, the pitch of each note of the octave is slightly shifted up or down from the standard (equal temperament) tuning.

1. Select **USER** for the **SCALING TYPE**.

2. Adjust the key scaling.
 - Use the balance buttons below the display to adjust the pitch of the corresponding key shown on the display.
 - Use the leftmost balance buttons below the display to switch between white keys and black keys.
 - Increments are in cents (one hundredth of an equal-tempered semitone). A + value raises the pitch and a - value lowers the pitch in relation to standard tuning (equal temperament).

Techni-chord Type

Select the desired harmony style for the **TECHNI-CHORD**.

1. On the **SOUND** menu display, select **TECHNI-CHORD**.
 - The display changes to the following.

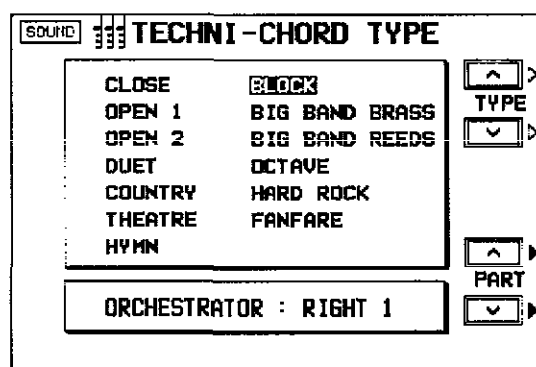

2. Use the **TYPE** \wedge and \vee buttons to select the harmony style.
 - When the **OCTAVE**, **HARD ROCK** or **FANFARE** style is selected, the **TECHNI-CHORD** functions even when the keyboard is not split.
 - For a detailed explanation of the different harmony styles, refer to the separate **REFERENCE GUIDE** provided.

■ ORCHESTRATOR

Use this function to specify which part plays the harmony notes. By assigning different sounds to the melody notes and harmony notes, you can achieve a striking **TECHNI-CHORD** performance.

Use the \wedge and \vee buttons to specify the part for the harmony notes.

- **LEFT** and **PART 16** cannot be selected.
- If **CONDUCTOR** is selected, the **CONDUCTOR** part which is currently selected will be specified as the part for the harmony notes. However, when **RIGHT 1** and **RIGHT 2** are both on, the harmony notes are produced in the sound for the **RIGHT 1** part.

You can also access this display by pressing and holding the **TECHNI-CHORD** button.

- In this case, the display exits the setting mode a few seconds after you make the setting.

Left Hold

Select the mode to specify how the left section of the keyboard sounds during an **AUTO PLAY CHORD** performance.

1. On the **SOUND** menu display, select **LEFT HOLD**.

- The display changes to the following.

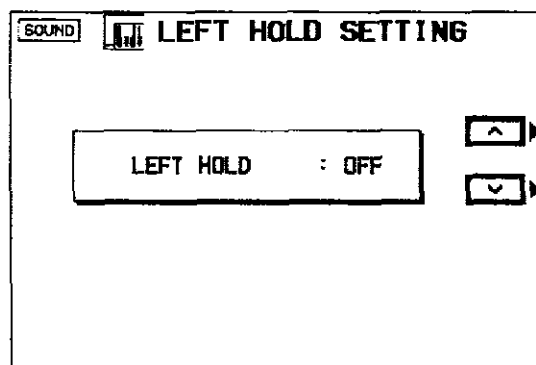

2. Use the **ON** and **OFF** buttons to set the mode to on or off.

■ OFF

	BASIC	ADVANCED 1, 2	PIANIST
When rhythm is stopped	The specified chord sounds in the CHORD part sound.	The specified chord sounds in the CHORD part sound, and the pressed keys sounds in the LEFT part sound.	The CHORD part and the LEFT part do not sound (the entire keyboard produces the RIGHT part sound).
When rhythm is playing	The CHORD part and the LEFT part do not sound.	The CHORD part does not sound, but the pressed keys sound in the LEFT part sound.	

■ ON

	BASIC	ADVANCED 1, 2	PIANIST
When the rhythm is stopped or playing	The specified chord sounds in the LEFT part sound.	The specified chord sounds in the LEFT part sound.	The CHORD part and the LEFT part do not sound (the entire keyboard produces the RIGHT part sound).

- In the **BASIC** and **ADVANCED** modes, you can use the mute function to specify whether the **LEFT** part sounds or not.

Reverb

Select the type and depth of the **DIGITAL REVERB**.

1. On the **SOUND** menu display, select **REVERB**.
 - The display changes to the following.

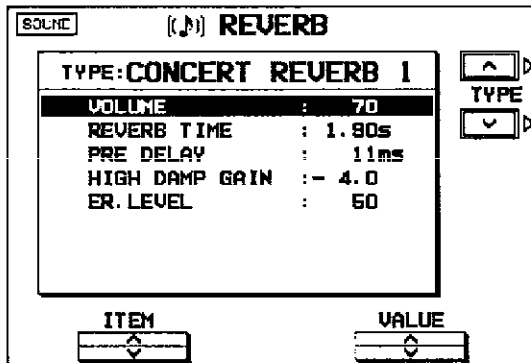

2. Use the **TYPE** \wedge and \vee buttons to select the type.
 - Details about each type and its parameters can be found in the separate **REFERENCE GUIDE** provided.

3. Use the **ITEM** \wedge and \vee buttons to select the parameter to adjust.
4. Use the **VALUE** \wedge and \vee buttons to change the setting.
5. Repeat steps 3 and 4 for the other parameters, as desired.

You can also access this display by pressing and holding the **DIGITAL REVERB** button.

- In this case, the display exits the setting mode a few seconds after you make the setting.

DSP Effect

Select the type of **DSP EFFECT** and make fine adjustments.

1. On the **SOUND** menu display, select **DSP EFFECT**.
 - The display changes to the following.

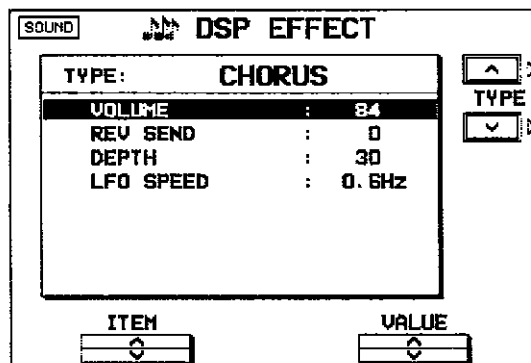

2. Use the **TYPE** \wedge and \vee buttons to select the type of effect.
 - Details about the parameters or each type can be found in the separate **REFERENCE GUIDE** provided.

3. Use the **ITEM** \wedge and \vee buttons to select the parameter.
4. Use the **VALUE** \wedge and \vee buttons to adjust the setting.
5. Repeat steps 3 and 4 for each parameter as necessary.
 - When a type of effect is selected, the parameters automatically revert to the factory defaults.

You can also access this display by pressing and holding the **DSP EFFECT** button.

- In this case, the display exits the setting mode a few seconds after you make the setting.

Part VII MIDI

What is MIDI?

MIDI (Musical Instrument Digital Interface) is the international standard for digital communication of electronic musical instrument data. This means that any equipment which has a MIDI terminal—such as electronic musical instruments and personal computers—can easily exchange digital data with other MIDI equipment without resorting to complicated conversions or connections.

MIDI terminals

(On the rear panel)

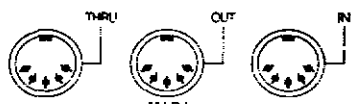

IN: The terminal by which this instrument receives data from other equipment.

OUT: The terminal that transmits data from this instrument to other equipment.

THRU: The terminal that transfers data from the IN terminal directly.

- For these connections, use a commercially available MIDI cable.

Connection examples

- To generate sound from a connected Instrument by playing this instrument

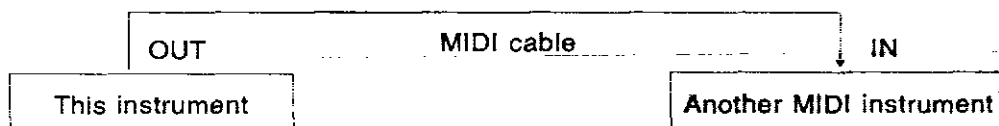

- To generate sound from this instrument by operating a connected instrument

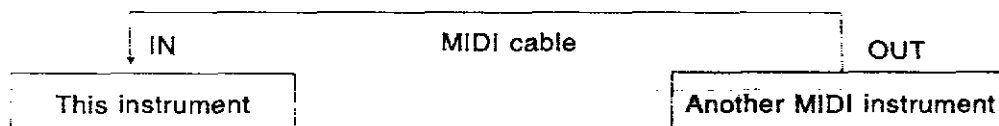

- To connect with a MIDI sequencer or a personal computer

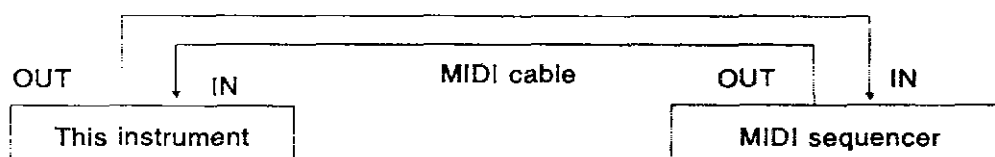

MIDI channels

Many different kinds of performance data are sent using just one MIDI cable. This is possible because MIDI signals are sent and received through 16 different "basic channels" (numbered 1 to 16). In order for the exchange of data to take

place, the channels on the transmission side must match the channels on the receiving side. This characteristic also makes it possible to link multiple sound generators and to control each by matching specific channels.

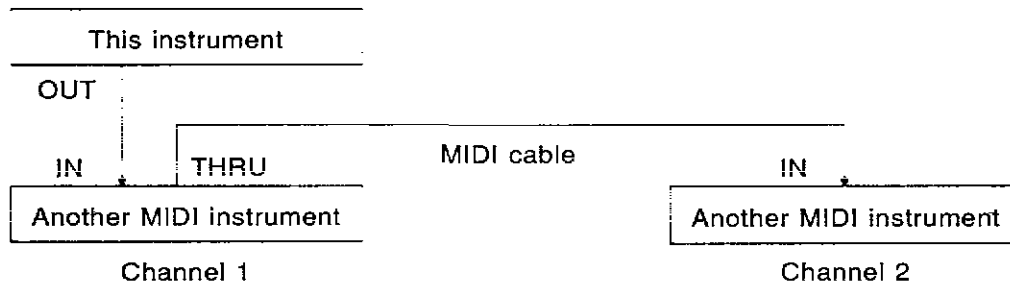

The following kinds of data can be transmitted/received.

■ NOTE data

This is the most basic kind of MIDI data which is exchanged, and is used to specify which keys are played and how hard they are played.

NOTE NUMBER: Number specifying which key is played.

NOTE ON: Specifies that a key is played.

NOTE OFF: Specifies that a key is released.

VELOCITY: Specifies how hard a key is struck.

- MIDI notes are assigned numbers from 0 to 127, with middle C (C3) as 60. Note pitches are in semitone increments, with the higher numbers assigned to the higher pitches.

■ PROGRAM CHANGE

This is sound change data. When a different sound is selected on the transmitting instrument, the sound on the receiving instrument also changes.

■ CONTROL CHANGE

These are volume, sustain, effect, etc. data used to enhance performance expression. Each function is distinguished by its control number, and the function which can be changed by the control differs depending on the instrument.

■ EXCLUSIVE data

This is sound data, etc. particular to a specific instrument model.

- For details, refer to the separate REFERENCE GUIDE provided.

GENERAL MIDI

GENERAL MIDI (GM) is the standard which enables MIDI data exchange between different models or equipment of different manufacture. Program change numbers and their corresponding sounds, percussion instrument sounds, note numbers, etc. are data-compatible between equipment using this standard. Song data created on the equipment of one manufacturer can be played back on the equipment of a different manufacturer, as long as both conform to the GENERAL MIDI standard. This instrument conforms to this standard and can be used as a GENERAL MIDI sound generator.

Equipment which conforms to GENERAL MIDI standards is indicated by the following logo.



Outline of MIDI functions



Select the various settings which are used for MIDI operation of this instrument.

1. Press the **MIDI** button to turn it on.



The display changes to the following.

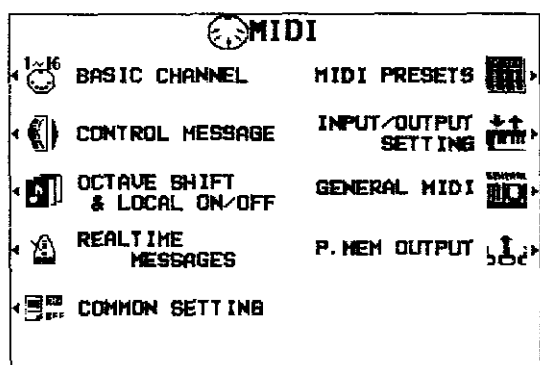

2. Select the desired menu and follow the procedures on the corresponding setting display.

- During the setting display, you can press the **EXIT** button to go back to the previous display. To show other menus, use the **EXIT** button to return to the **MIDI** menu display and make another selection.
- When the **TEMPO/PROGRAM** indicator is lit, it indicates that the dial is available for setting the current function.

3. When you have finished setting the functions, press the **MIDI** button to turn it off.

Summary of the MIDI menu items

BASIC CHANNEL (page 121)

Assign a MIDI channel to each part.

CONTROL MESSAGE (page 121)

Enable or disable the exchange of various control data.

OCTAVE SHIFT & LOCAL ON/OFF (page 122)

Make the **OCTAVE** and **LOCAL CONTROL** settings for each part.

REALTIME MESSAGES (page 122)

Make the **REALTIME COMMANDS** and **CLOCK** settings.

COMMON SETTING (page 123)

Set the following functions which are common to all parts.

NOTE ONLY

PROG. CHANGE TO P. MEM
INTRO, FILL-IN, ENDING

APC CONTROL

TRANPOSE
PROGRAM CHANGE MODE
DRUMS TYPE
SONG SELECT
MIDI SETUP LOAD

MIDI PRESETS (page 124)

Optimum MIDI settings according to the connected equipment

INPUT/OUTPUT SETTING (page 124)

Various settings related to transmission and reception of data

GENERAL MIDI (page 125)

GENERAL MIDI settings

P. MEM OUTPUT (page 126)

Settings related to the transmission data when the **PANEL MEMORY** buttons are operated.

Setting the functions

BASIC CHANNEL

MIDI Basic Channel numbers have already been assigned to parts (default settings) but you can reassign channel number to parts as follows.

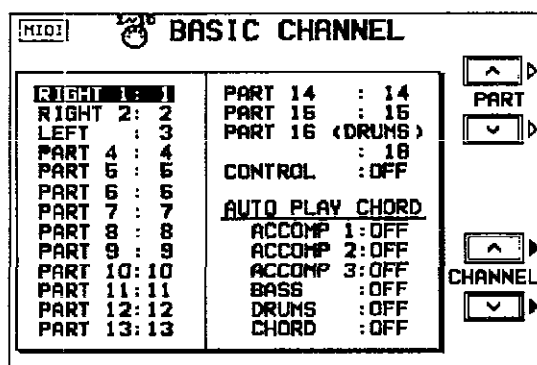

1. Use the PART \wedge and \vee buttons to select the part.
2. Use the CHANNEL \wedge and \vee buttons to select a basic channel for the part (OFF, 1 to 16).
 - A part which has been set to OFF cannot be used to transmit or receive MIDI data.
3. Repeat steps 1 and 2 for each part as desired.
 - The illustrated display shows the initialized settings.

CONTROL MESSAGE

Enable or disable the exchange of various control data.

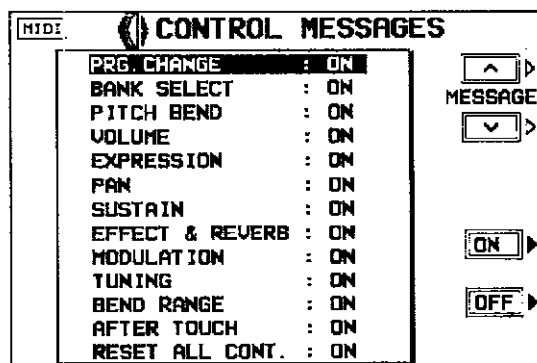

1. Use the MESSAGE \wedge and \vee buttons to select the control message.
2. Use the ON and OFF buttons to specify on or off for the control message.

ON: Data for the control operation is exchanged.

OFF: Data for the control operation is not exchanged.

 - The BANK SELECT setting is effective only when PRG. CHANGE is set to ON.
 - The EFFECT & REVERB setting controls the **DIGITAL EFFECT**, **DSP EFFECT** and **DIGITAL REVERB** on/off.
 - The TUNING setting is the on/off setting for the TUNING and KEY SHIFT settings.
3. Repeat steps 1 and 2 for each control as desired.

OCTAVE SHIFT & LOCAL ON/OFF

Set the octave shift value for key notes transmitted from this instrument (OCTAVE), and specify whether this instrument's sound generator is enabled when MIDI data is transmitted (LOCAL CONTROL).

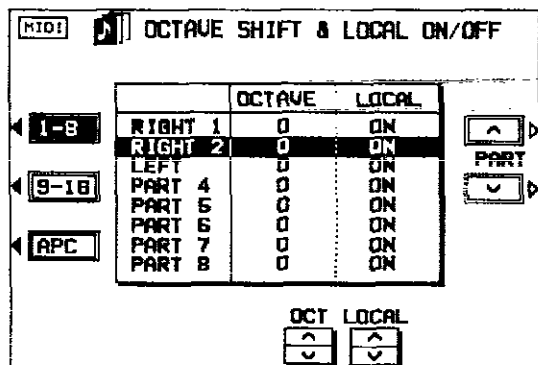

- Use the buttons on the left side of the display to select the corresponding group of the part you wish to set.

1-8: RIGHT 1, RIGHT 2, LEFT, PART 4 to PART 8 group
 9-16: PART 9 to PART 16 group
 APC: ACCOMP 1 to 3, BASS, DRUMS, CHORD group

- Use the PART \wedge and \vee buttons to select the part.

OCTAVE: Use the OCT \wedge and \vee buttons to set the octave shift value (-3 to 3).

- Octave shift is set for transmitted data only; however the transmitted and received octave shifts are linked. For example, if the transmitted octave shift is set to 1, the received octave shift is automatically set to -1.

LOCAL: Use the LOCAL \wedge and \vee buttons to enable or disable this instrument's sound generator.

- When set to ON, the performance from this instrument is transmitted as MIDI data and also sounds from this instrument. When set to OFF, the performance from this instrument is transmitted as MIDI data but does not sound from this instrument.

- Repeat steps 1 and 2 for each part as desired.

REALTIME MESSAGES

Enable or disable the exchange of START/STOP data (REALTIME COMMANDS), and select the CLOCK mode.

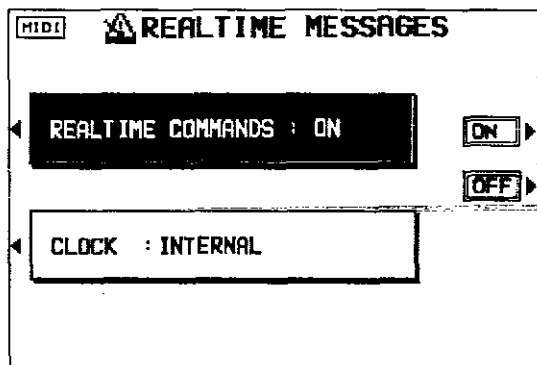

- Use the buttons on the left side of the display to select a function.
- Use the \wedge and \vee buttons, or the ON and OFF buttons, to change the setting.

REALTIME COMMANDS

ON: Rhythm and SEQUENCER start/stop, continue, and song position pointer data can be transmitted/received.

OFF: This data cannot be transmitted/received.

CLOCK

INTERNAL: This instrument's internal clock is used to control the performance. The clock of the connected equipment is disabled.

MIDI: The clock of the connected equipment is used to control the performance. This instrument's clock is disabled. (The tempo is displayed as " = - - -.")

- The CLOCK is set to INTERNAL when the power to this instrument is turned on.

- Repeat steps 1 and 2 for the other function if desired.

COMMON SETTING

Set the functions which are common to all parts.

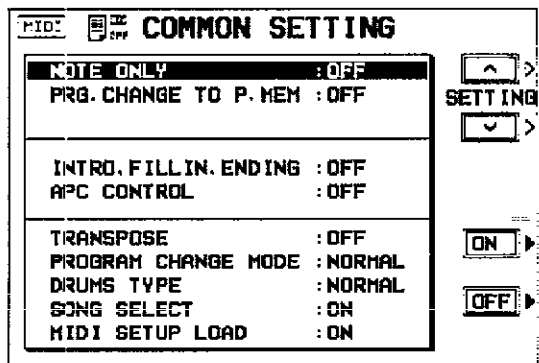

1. Use the SETTING \wedge and \vee buttons to select the item.

NOTE ONLY: Of the performance data, specify whether or not only note data is exchanged.

PROG. CHANGE TO P. MEM: Enable or disable the exchange of program change numbers for the **RIGHT 1** part by operation of the **PANEL MEMORY** buttons.

- For this setting, the **PANEL MEMORY 1** to **5** program change numbers correspond to the bank numbers as follows:
BANK A = 0 to 4
BANK B = 5 to 9

INTRO, FILL-IN, ENDING: Enable or disable the exchange of intro, fill-in and ending data.

- Data is exchanged on the channel for the **DRUMS** part.

APC CONTROL: Enable the exchange of data for the on/off status of the **AUTO PLAY CHORD's** BASIC, ADVANCED 1, 2 and PIANIST modes.

- Data is exchanged on the channel for the **ACCOMP 1** part.

TRANSPOSE

- ON: The note number of the transposed note is transmitted/received.
- OFF: The note number of the played key is transmitted/received.

PROGRAM CHANGE MODE

NORMAL: The program change numbers are as indicated in the REFERENCE GUIDE.

TECH: Program change numbers are standardized among all Technics models which are set to this mode. The program change number assigned to a given sound on one model is assigned to the same sound on all models which are set to the same mode.

GM: Program change numbers follow the GM standard.

- The program change numbers for each mode can be found in the separate REFERENCE GUIDE provided.

DRUM TYPE

NORMAL: Keyboard percussion instrument sounds correspond to this instrument's key note numbers.

TECH: Keyboard percussion instrument sounds correspond to the same key note numbers for connected Technics models set to this type.

GM: Keyboard percussion instrument sounds follow the GM standard.

SONG SELECT

- ON: Song number data can be exchanged.
- OFF: Song number data cannot be exchanged.

MIDI SETUP LOAD

- ON: When disk data is loaded, the MIDI settings stored on the disk are automatically recalled.
- OFF: MIDI settings stored on the disk are not recalled.

2. Use \wedge and \vee buttons or ON and OFF buttons to change the setting.

- ON: Data exchange is enabled.
- OFF: Data exchange is disabled.

3. Repeat steps 1 and 2 for the other settings as desired.

MIDI PRESETS

Establish the optimum settings depending on how this instrument is connected to other equipment, and on whether this instrument is used as the master or the slave.

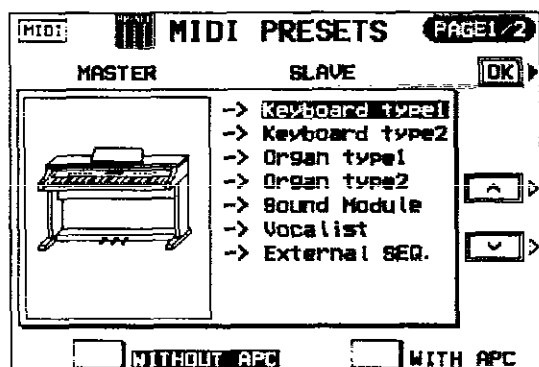

- Use the \wedge and \vee buttons to select the connection setup.
 - The PAGE 1/2 display shows connection setups with this instrument as the MASTER. And the PAGE 2/2 display shows connection setups with this instrument as the SLAVE.
 - The MASTER is the instrument used to transmit data, and the SLAVE is the instrument used to receive the data.
 - Use the buttons below the display to select WITHOUT APC (the AUTO PLAY CHORD is not used) or WITH APC (the performance includes AUTO PLAY CHORD).

- Press the OK button.

- When the settings have been successfully stored, "COMPLETED!" appears on the display.
- Detailed information about the MIDI PRESETS can be found in the separate REFERENCE GUIDE provided.
- The list names on the display are subject to change.

INPUT/OUTPUT SETTING

Make the settings which determine how various performance data is treated during data transmission and reception.

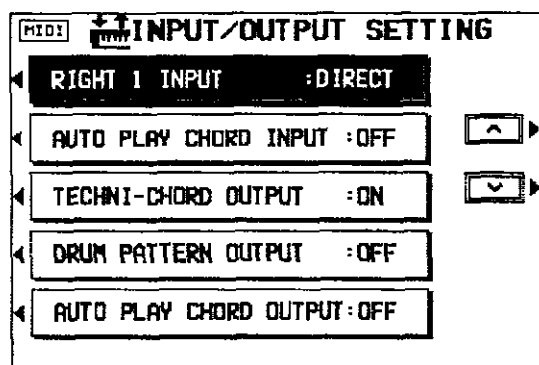

- Use the buttons on the left side of the display to select the item.

RIGHT 1 INPUT

CONDUCTOR: When data for the **RIGHT 1** part is received, the **CONDUCTOR** determines which part it is used for.

DIRECT: When data for the **RIGHT 1** part is received, it is treated as **RIGHT 1** data, and performance data for all parts is received on their respective basic channels.

AUTO PLAY CHORD INPUT

ON: Input data for the **ACCOMP 1, 2, 3, BASS, DRUMS** and **CHORD** parts is received.

OFF: Data for the above parts is not received.

- Basic channels should be assigned to the above parts before exchanging data.

TECHNI-CHORD OUTPUT

ON: Keyboard notes generated by the **TECHNI-CHORD** function are also transmitted.

OFF: Only key note data of the pressed keys is transmitted.

DRUM PATTERN OUTPUT

ON: Data from the **DRUMS** part is transmitted.

OFF: Data from the **DRUMS** part is not transmitted.

AUTO PLAY CHORD OUTPUT

ON: The data for the **ACCOMP 1, 2, 3, BASS** and **CHORD** parts is transmitted.

OFF: The data for the above parts is not transmitted.

- Basic channels should be assigned to the above parts before exchanging data.

2. Use the \wedge and \vee buttons, or the ON and OFF buttons, to select the setting.

3. Repeat steps 1 and 2 for each item as desired.

GENERAL MIDI

GENERAL MIDI (GM) is the standard which enables MIDI data exchange between different models or equipment of different manufacture. Program change numbers and their corresponding sounds, percussion instrument sounds, note numbers, etc. are data compatible between equipment using this standard.

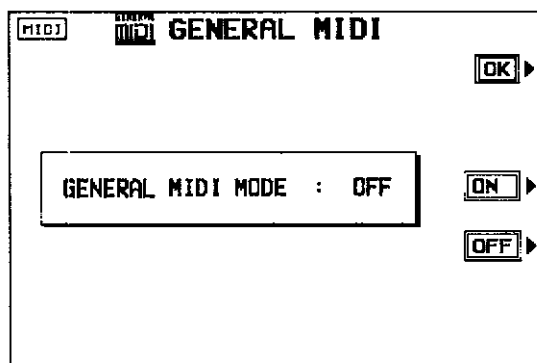

1. Use the ON and OFF buttons to specify whether or not this instrument should be compatible with GENERAL MIDI standard instruments.

- This setting is automatically set to OFF when the power is turned on.
- If ON is selected, the status of this instrument changes to the GENERAL MIDI status, and the sounds and operations which can be selected are limited. In addition, the arrangement of percussion sounds on the keyboard changes. (Refer to the separate REFERENCE GUIDE provided.)
- This setting is automatically set to ON if disk data other than Technics data is loaded.

2. Press the OK button.

- The confirmation display appears. Press the YES button to execute the function, or press the NO button to cancel the function.
- If ON was selected, GENERAL MIDI is shown on the normal performance display.
- When this function is executed, the **SEQUENCER** memory is cleared and the panel settings are reset.
- If ON is selected, this setting is automatically set to OFF when the power is turned off, and the **SEQUENCER** memory is cleared.

PANEL MEMORY OUTPUT

These are settings affect the transmission data when the **PANEL MEMORY** buttons are operated.

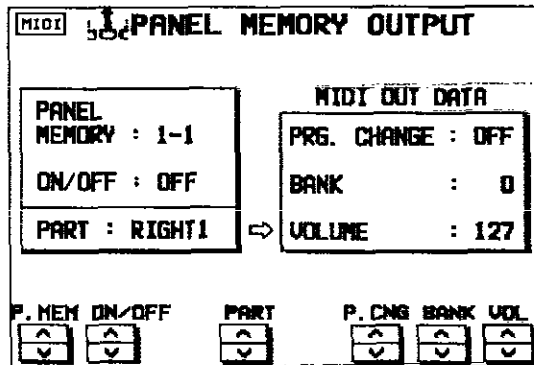

1. Use the P.MEM \wedge and \vee buttons to select a **PANEL MEMORY** number.
2. Use the ON/OFF \wedge and \vee buttons to specify whether the data in the selected **PANEL MEMORY** number is transmitted or not.
3. Use the PART \wedge and \vee buttons to select a part (RIGHT 1, RIGHT 2 or LEFT).
4. Use the P.CNG \wedge and \vee buttons to specify a program change number (0 to 127, or OFF).
5. Use the BANK \wedge and \vee buttons to specify a bank select number (0 to 255).
6. Use the VOL \wedge and \vee buttons to specify the volume (0 to 127, or OFF).
7. Repeat steps 3 to 6 for each part, as necessary.
8. Repeat steps 1 to 7 for each **PANEL MEMORY** number, as necessary.

Initialize

This instrument has many settable functions and storable memories. However, you can return the settings and memory to the factory-preset status.

INITIAL

1. Press the **MEMORY & CONTROL** button to turn it on.

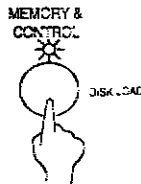

- The display changes to the following.

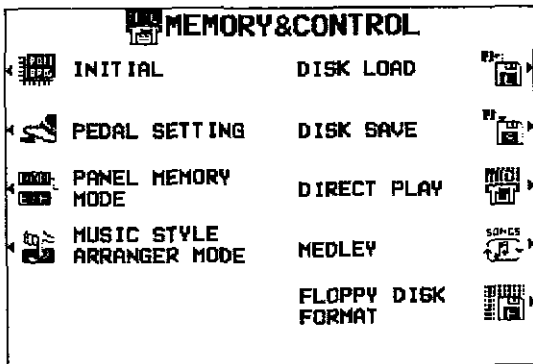

2. Select **INITIAL**.

- This display changes to the following.

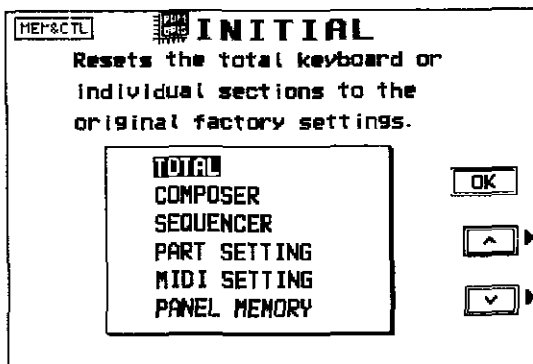

3. Use the \wedge and \vee buttons to select the desired type of initialization (TOTAL, COMPOSER, SEQUENCER, PART SETTING, MIDI SETTING or PANEL MEMORY).

4. Press the **OK** button.

- The display changes to the confirmation display. Press the **YES** button if you wish to execute the initialization. Press the **NO** button if you wish to cancel the procedure.

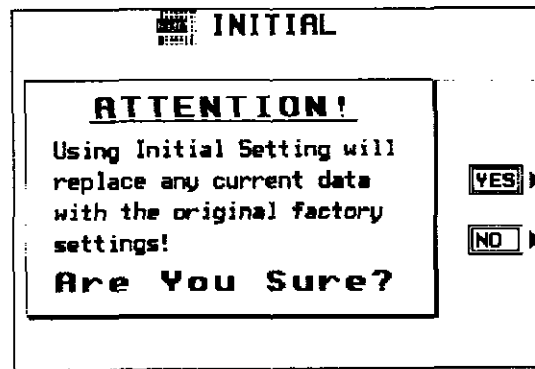

- When you press the **YES** button, initialization begins. When initialization is completed, "COMPLETED!" is shown on the display and the instrument returns to the normal performance mode.
- You can also reset all the instrument settings with the following procedure: Turn off the **POWER** button once. Then, while pressing the three lower left buttons in the **RHYTHM GROUP** section (**ROCK, FUNK & FUSION** and **TRAD DANCE**) at the same time, turn the **POWER** button on again.
- All the instrument settings may be initialized when the power is turn on, for example, if the effective time of the backup memory has been exceeded.

■ About the backup memory

The settings and memories are maintained for approximately 80 minutes after the power to this instrument is turned off. If you wish to keep the memory contents, before you turn off the instrument, use the SAVE procedure to store the desired data on a disk for recall at a later time.

- The backup memory does not function until the power has been on for about 10 minutes.
- When you quit the operating mode, a warning display may appear to remind you to save the data.

Power on settings

When the **POWER** button of this instrument is turned on, the settings below are automatically set to those suitable for piano performance.

PLAY STYLE: PIANO MODE

Sound: **GRAND PIANO**

TRANSPOSE: C

SUSTAIN PEDAL: On

SYNCHRO START: Off

MINIMUM RANGE: On

All **PART SETTING** items for the **RIGHT 1** part:

Appropriate values

PEDAL SETTING:

Left: **SOFT**

Center: **SOSTENUTO**

- When you turn the power on, you can recall all the settings which were in effect at the time you turned the instrument off: while depressing the sustain (right) pedal, turn on the power.

Connections

(On the back of the piano)

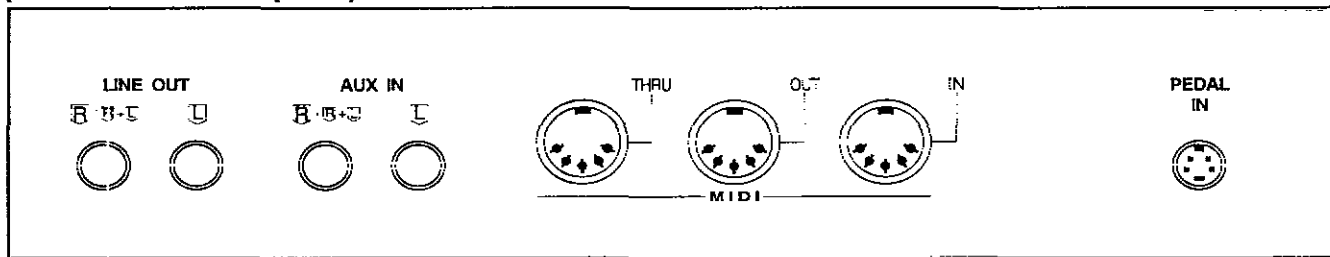

MIDI

These terminals are for connection to another MIDI instrument. (Refer to page 118.)

PEDAL IN

Connect the included pedal.

AUX IN (input level 0.5 Vrms, 6 k Ω)

Other instruments such as a rhythm machine or sound module can be connected to the piano so that the sound is output from the piano. To receive monaural sound, connect instruments to the R/R+L terminal.

LINE OUT (output level 1.5 Vrms, 600 Ω)

By plugging into a high-power amplifier, the sound can be reproduced at a high volume. (Use the R/R+L terminal when outputting monaural sound.)

phones \times 2

(Beneath the keyboard, on the left side)

For silent practice, headphones may be used. When plugged in, the speaker system is automatically switched off, and sound is heard only through the headphones.

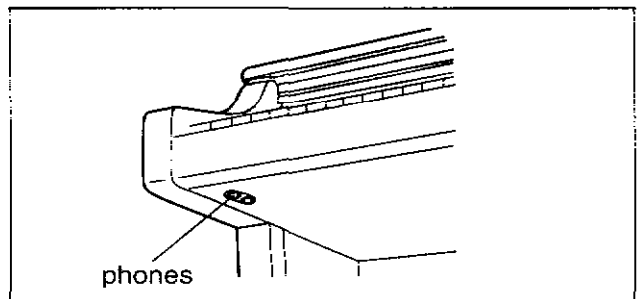

Assembly (PR700)



Follow the steps below to assemble your Technics piano. Make sure you are using the correct parts and that they are in the correct direction.

- At least 2 people are required for assembly.
- To disassemble the piano, reverse the procedure.

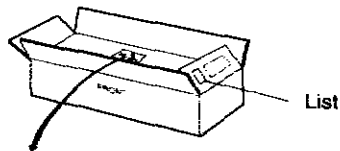
1. Remove the packing and take the parts out of the carton. Confirm that all the parts on the printed list are present.



2. The following parts are in the screw kit.

-  Brass-colored screws4
-  Black screws8
-  Clamps3

3. Affix the right and left side planks to the pedal box.

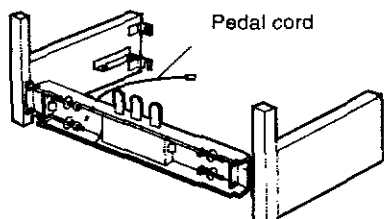

- (1) Use the 4 brass-colored screws to secure the planks.
- (2) Loosen the pedal cord, stowed on the inner side of the pedal box, and extend it.

4. Affix the speaker box.

- Use 4 black screws to affix the speaker box to the side planks.

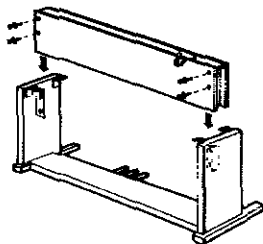

5. Place the piano body on the stand.

WARNING:
Avoid pinching your fingers.

Note 1
Holding the piano body at least 10 cm in from the edge, place it on the stand so that it does not fall off.

Note 2
If the piano body is placed too far to the right or left, or to the front or back, it will become unstable.

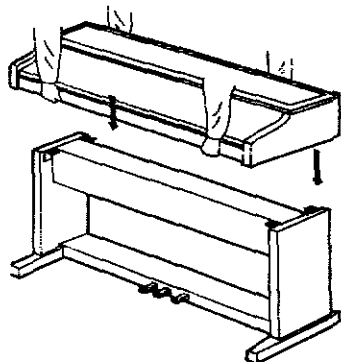

6. Secure the piano body to the stand.

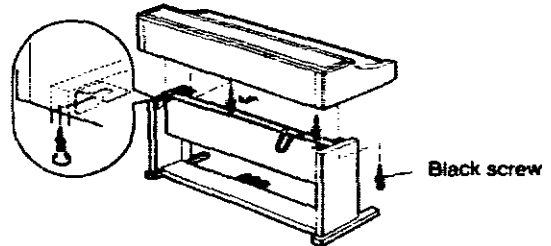

- (1) Insert 2 screws in the 2 rear screw holes on the underside of the piano body, and turn each screw 5 or 6 times. Push the piano body forward so that the screws are fully inserted in the cutout of the metal piece on either side plank. (This enables you to easily position the piano body on the stand.)
- (2) Adjust the piano body so that the right and left sides project evenly over the stand.

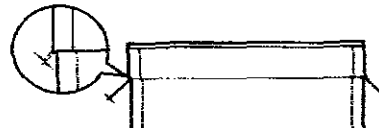

- (3) Positioning the piano body on the stand, confirm that the 4 screws can easily be inserted.
- (4) Tighten the 4 screws securely.

7. Connect the pedal cord, power cord and speaker cord to the terminals.

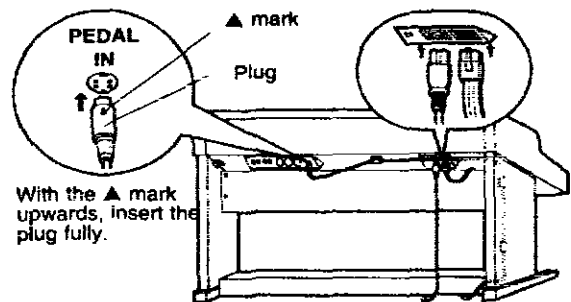

- (1) Plug the pedal cord, power cord and speaker cord into the terminals on the rear of the piano.
- (2) Remove the backing from the clamps and affix them as shown in the figure. Secure the pedal cord to the clamps.

Confirm: After assembling, check these points.

- Are any parts left over?
→ Check the assembly procedure again.
- Does the piano rattle when it is rocked?
→ Make sure all the screws are securely tightened.
- Are the speaker cord and power cord firmly inserted?
→ Check again.
- Is the plug of the pedal cord inserted as far into the connector terminal as it will go?
→ If it is not completely inserted, the sustain and other pedal functions may not work.
- When the piano has been moved or transported, retighten the screws securely.

Assembly (PR900)



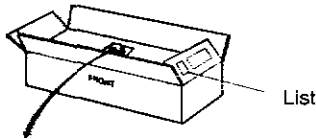

Follow the steps below to assemble your Technics piano. Make sure you are using the correct parts and that they are in the correct direction.

- At least 2 people are required for assembly.
- To disassemble the piano, reverse the procedure.

1. Remove the packing and take the parts out of the carton. Confirm that all the parts on the printed list are present.



2. The following parts are in the screw kit.

-  Black screws (long) 12
-  Black screws (short) 2
-  Brass-colored screws (long) 3
-  Brass-colored screws (short) 2

3. Affix the right and left side planks to the speaker box.

- Use 8 long black screws to secure the planks.

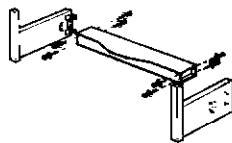

4. Assemble the pedal box.

- Use 2 short brass-colored screws and 1 long brass-colored screw to affix the pedal box to the support.

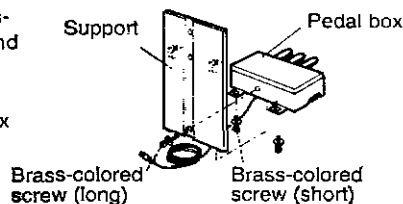

5. Affix the pedal box unit to the speaker box.

- (1) Use 2 long brass-colored screws and 2 short black screws to affix the pedal box unit to the speaker box.
- (2) Lay the pedal cord in the groove on the support, and then affix the cord cover.

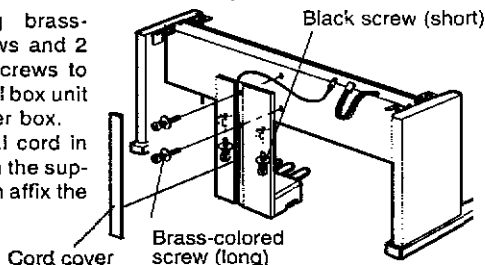

6. Place the piano body to the stand.

WARNING:
Avoid pinching your fingers.

Note 1
Holding the piano body at least 10 cm in from the edge, place it on the stand so that it does not fall off.

Note 2
If the piano body is placed too far to the right or left, or to the front or back, it will become unstable.

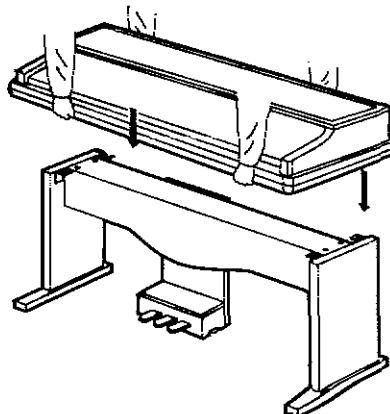

7. Secure the piano body to the stand.

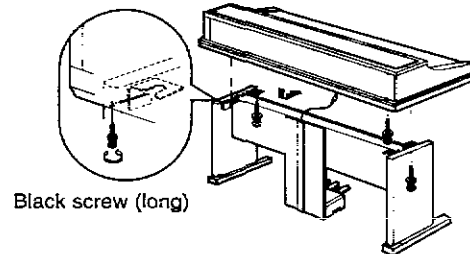

- (1) Insert 2 screws in the 2 rear screw holes on the underside of the piano body, and turn each screw 5 or 6 times. Push the piano body forward so that the screws are fully inserted in the cutout of the metal piece on either side plank. (This enables you to easily position the piano body on the stand.)
- (2) Adjust the piano body so that the right and left sides project evenly over the stand.

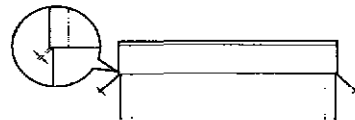

- (3) Positioning the piano body on the stand, confirm that the 4 screws can easily be inserted.
- (4) Tighten the 4 screws securely.

8. Connect the pedal cord, power cord and speaker cord to the terminals.

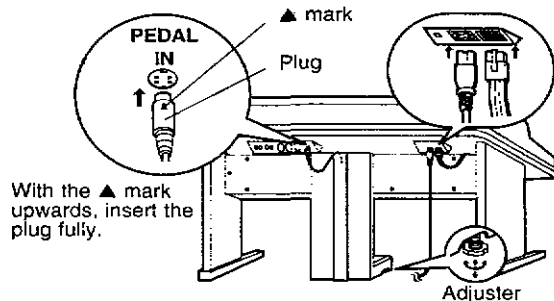

- (1) Plug the pedal chord, power cord and speaker cord into the terminals on the rear of the piano.
- (2) When the piano is in place, turn the adjuster to stabilize the pedal box.

Confirm: After assembling, check these points.

- Are any parts left over?
→ Check the assembly procedure again.
- Does the piano rattle when it is rocked?
→ Make sure all the screws are securely tightened.
- Are the speaker cord and power cord firmly inserted?
→ Check again.
- Is the plug of the pedal cord inserted as far into the connector terminal as it will go?
→ If it is not completely inserted, the sustain and other pedal functions may not work.
- Does the pedal box move when the pedals are pressed?
→ Turn the adjuster to stabilize the pedal box.
- When the piano has been moved or transported, retighten the screws securely.

Symptoms which appear to be signs of trouble

The following changes in performance may occur in this instrument but do not indicate trouble.

	Phenomenon	Remedy
Sounds and effects	The buttons, keys, etc. malfunction.	<ul style="list-style-type: none"> • Turn off the POWER button once, then turn it on again. If this procedure is not successful, turn off the POWER button once. Then, while pressing the three lower left buttons in the RHYTHM GROUP section (ROCK, FUNK & FUSION and TRAD DANCE) at the same time, turn the POWER button on again. (Note that, in this case, all programmable settings, functions and memories return to their factory-preset status.)
	No sound is produced when the keys are pressed.	<ul style="list-style-type: none"> • The MAIN VOLUME is at the minimum setting. Adjust the volume with the MAIN VOLUME control. • The volumes for the selected parts are set to the minimum levels. Use the balance buttons to set the volumes of the relevant parts to appropriate levels. (Refer to page 22.) • The part is muted. (Refer to page 22.) • The local control for a part performed on the keyboard is set to OFF. Set the local control to ON. (Refer to page 122.)
	Only percussive instrument sounds are produced when the keyboard is played.	<ul style="list-style-type: none"> • In the SOUND GROUP section, the KEYBOARD PERC button is on.
	The volume is very low when the keyboard is played.	<ul style="list-style-type: none"> • The volume setting in the SEQUENCER contents is very low. Follow the INITIAL procedure to reset the settings. (Refer to page 127.)
	Some sounds cannot be selected.	<ul style="list-style-type: none"> • When the GENERAL MIDI status is set to on, The sounds which can be selected and operation which can be executed are limited. Turn the GENERAL MIDI status off to return the instrument to its normal operation. (Refer to page 125.)
	The sound you hear is different from the sound you selected.	<ul style="list-style-type: none"> • This sometimes occurs when you play back SEQUENCER or COMPOSER data which was created on a different model, or when MIDI data is received from a connected instrument. Select the desired sounds again.
	The sustain does not work even when the sustain pedal is depressed.	<ul style="list-style-type: none"> • The sustain pedal is not connected. Connect the pedal cord firmly to the PEDAL IN terminal on the back of the instrument. • When the SUSTAIN PEDAL button is off, the sustain does not work even when the pedal is depressed. Turn on the SUSTAIN PEDAL button.
	The sostenuto pedal and soft pedal do not operate properly. For example, when the soft pedal is depressed, the rhythm starts or a fill-in is played.	<ul style="list-style-type: none"> • Different functions can be programmed in these pedals. You can return the pedals to their original functions by turning off the instrument once, or by using the PEDAL SETTING mode. (Refer to page 53.)

	Phenomenon	Remedy
Rhythm	The rhythm does not start.	<ul style="list-style-type: none"> • The RHYTHM VOLUME sliding controller is set to OFF. Set the volume to an appropriate level. • The DRUMS volume is set to the minimum level. Use the balance buttons to set the DRUMS volume to an appropriate level. • A rhythm in COMPOSER MEMORY with no stored pattern was selected. Select a different rhythm. • The PLAY button in the SEQUENCER section is on. When you are not playing back the SEQUENCER performance, turn off the PLAY button. • CLOCK is set to MIDI. Set CLOCK to INTERNAL. (Refer to page 122.) • The rhythm does not work when the GENERAL MIDI mode is set to ON. Turn the GENERAL MIDI status off to return the instrument to its normal operation. (Refer to page 125.)
	No sound is produced for the automatic accompaniment.	<ul style="list-style-type: none"> • The RHYTHM VOLUME sliding controller is set to OFF. Set the volume to an appropriate level. • A rhythm in COMPOSER MEMORY with no stored pattern was selected. Select a different rhythm.
AUTO PLAY CHORD	No sound is produced for the automatic accompaniment, or only the sounds of some parts are produced.	<ul style="list-style-type: none"> • An ACCOMP part does not sound if its corresponding volume is set to the minimum level. Use the respective balance buttons to set the ACCOMP 1, 2 and 3 volumes to appropriate levels.
	Storage is not possible.	<ul style="list-style-type: none"> • The remaining memory capacity of the SEQUENCER is 0. Follow the SONG CLEAR or TRACK CLEAR procedure to erase the memory. (Refer to page 75.)
SEQUENCER	Multi-track storage is not possible.	<ul style="list-style-type: none"> • The playback track has been selected, but the START/STOP button has not been pressed. On the recording display, the track with a REC mark is the track which is ready for recording; a track with a PLAY mark is a track which is ready for playback. To record one track while listening to another (playback) track, press the START/STOP button to begin playback.
	The playback measure indication is different from when the performance was recorded.	<ul style="list-style-type: none"> • The number of measures corresponds to the time signature of the rhythm selected at the start of recording. To change the rhythm in the middle of the song, record the rhythm change in the RHYTHM part. (Refer to page 67.)

	Phenomenon	Remedy
COMPOSER	Storage is not possible.	<ul style="list-style-type: none"> • The remaining memory capacity of the COMPOSER is 0.
	Setting the time signature and number of measures is not possible.	<ul style="list-style-type: none"> • The time signature and number of measures cannot be changed for a pattern which is currently recorded in the COMPOSER. If you wish to change the time signature and/or measure data, first follow the procedure to clear the memory. (Refer to page 88.)
	The playback timing of the rhythm pattern is different from the timing with which it was recorded.	<ul style="list-style-type: none"> • The QUANTIZE function was on when the pattern was recorded and the timing was automatically corrected. Set the quantize level to a smaller note unit or to OFF when recording. (Refer to page 92.)
Disk Drive	The Disk Drive produces a noise during recording or playback.	<ul style="list-style-type: none"> • This occurs when the Disk Drive is reading a disk. It does not indicate a problem.
	When the procedure to load from a disk is performed, the contents of this instrument's memory are erased.	<ul style="list-style-type: none"> • When performing the load operation from a disk, this instrument's memory changes to that of the data loaded from the disk. If you wish to preserve a song which is stored in this instrument's memory, save it on a disk before performing the load procedure. (Refer to page 103)
Other	Noise from a radio or TV can be heard.	<ul style="list-style-type: none"> • This sometimes occurs when electrical equipment such as a radio or TV is used near the instrument. Try moving such electrical equipment further away from the instrument. • The sound may be coming from a nearby broadcast station or amateur radio station. If the sound is bothersome, consult your dealer or service center.
	The cabinet becomes warm during use.	<ul style="list-style-type: none"> • This instrument has a built-in power source that heats the cabinet to some degree. This is not an indication of trouble.

Error messages

No.	Contents
00	The data on the disk that you are using is for a different product.
01	An error has occurred while the disk was loading. Please try again!
02	There is no disk in the Disk Drive.
03	The file that you tried to load is empty.
05	An error has occurred while the disk was saving. Please try again!
06	The disk that you are using is write protected. Please remove the write protection and try again.
07	The disk that you are using is full. Please use another disk.
08	An error has occurred while the disk was formatting. The disk that you are using may be faulty. Please try formatting another disk.
10	The data is already copy protected.
20	A problem has occurred with your SEQUENCER Data. This might be due to a damaged or faulty disk.
21	Memory full
22	It is necessary to press PUNCH OUT to complete this procedure.
23	It is impossible to change the time signature because it has already been set in the existing tracks.
24	A rhythm track already exists. It is impossible to assign two tracks to rhythm.
25	It is only possible to change the velocity on a melody track.
26	It is only possible to merge melody tracks. Tracks such as rhythm, chord and control cannot be merged.
27	It is only possible to copy melody tracks. Tracks such as rhythm, chord and control cannot be copied.
28	This song is too long to be saved as a MIDI file.
29	The MIDI file that you have tried to load exceeds the memory capacity of this instrument and cannot be played. The SEQUENCER memory has been cleared.

No.	Contents
30	It is not possible to change the time signature or measure length of a COMPOSER pattern after it has been recorded. If you want to proceed, you must first clear the entire COMPOSER pattern.
31	The time signature of the pattern from which you are copying is different from the COMPOSER memory that you are using. Either: Change the time signature of the COMPOSER memory or: Copy from a pattern that has the same time signature
32	Memory full
43	The file that you are trying to load was saved on a previous PR series. It is only possible to load using the "ALL" option.
47	Please select a preset pattern.
55	Special tracks such as CHORD, RHY and CTL exist in the song from which you are copying and are incompatible with the destination song because it is in the GM mode.
56	AUTO PUNCH recording has been unsuccessful because SEQUENCER operation was interrupted before the PUNCH OUT measure was reached.
57	The COMPOSER pattern you have chosen has a different time signature or number of measures from the other patterns in this COMPOSER CHORD MAP. All of the COMPOSER patterns used in a COMPOSER CHORD MAP must have the same time signature and number of measures.
58	The song that you have tried to load exceeds this instrument's available memory and cannot be loaded. The selected song memory has been cleared. Please clear existing songs in the instrument's memory using SONG CLEAR to make more memory available, and try again.
59	RKB and LKB are special tracks for compatibility with sequencer data from previous PR products. They cannot be edited or recorded on.
60	RKB and LKB are special tracks which cannot be used in conjunction with RIGHT 1, RIGHT 2, LEFT and APC tracks. Please re-assign RKB and LKB to any other part and try again.

Index

A	
ADVANCED 1, 2	45
APC CONTROL, MIDI	123
AUTO PLAY CHORD	43
AUTO PLAY CHORD INPUT, MIDI	124
AUTO PLAY CHORD OUTPUT, MIDI	125
AUX IN	129
B	
Backup memory	128
BANK	51
BASIC	44
BASIC CHANNEL, MIDI	121
BEAT	41
BRILLIANCE	37
C	
CHORD STEP RECORD	65
CLOCK, MIDI	122
COMMON SETTING, MIDI	123
COMPOSER	84
COMPOSER CHORD MAP	95
CONDUCTOR	28
Connections	129
CONTRAST	25
CONTROL MESSAGE, MIDI	121
COUNT INTRO	42
D	
DEMO	11
DIGITAL DRAWBAR (PR900)	30
DIGITAL EFFECT	36
DIGITAL REVERB	37
DIRECT PLAY	101
Disk Drive	97
DISK LOAD	99
DISK SAVE	103
Display	22
DISPLAY HOLD	25
DRUM EDIT	72
DRUM PATTERN OUTPUT, MIDI	125
DRUMS TYPE, MIDI	123
DSP EFFECT	36
E	
EASY COMPOSER	86
EASY RECORD	57
ENDING	43
Error messages	135
EXIT	25
F	
FILL IN	43
FILL IN SELECT	90
Fingered	44
FLOPPY DISK FORMAT	102

G	
GENERAL MIDI (GM)	119, 125
GLIDE	53
H	
Headphones	129
HELP	26
I	
INITIAL	127
INPUT/OUTPUT SETTING, MIDI	124
INTRO & ENDING	42, 43
K	
KEY SCALING	114
KEY SHIFT	110
KEYBOARD PERC	29
KEYBOARD SPLIT	32
L	
LANGUAGE SELECT	26
LEFT HOLD	116
LEFT SELECT	32
LINE OUT	129
LOAD SINGLE COMPOSER PATTERN	101
LOCAL CONTROL, MIDI	122
M	
MAIN VOLUME	10
MASTER TUNING	113
MEASURE COPY	78
MEASURE ERASE	79
MEASURE & TIME SIGNATURE	90
MEMORY, COMPOSER	92
MEMORY & CONTROL	98
MENU	23
METRONOME	41
MIDI	118
MIDI FILE SAVE	105
MIDI FILE LOAD	100
MIDI PRESETS	124
MIDI SETUP LOAD	123
MIXER	112
Music stand	10
MUSIC STYLE SELECT	49
MUSIC STYLE ARRANGER	50
MUTE	22
N	
NOTE EDIT	70
NOTE ONLY, MIDI	123
O	
OCTAVE SHIFT, MIDI	122
ON BASS	45
One finger	44

ONE TOUCH PLAY	48
OTHER PARTS	23
OVERALL TOUCH SENSITIVITY	113

P

PAGE	23
PAN	108
PANEL MEMORY	51
PANEL MEMORY OUTPUT, MIDI	126
PANEL WRITE	78
PART SETTING	107
Pedal	34
PEDAL SETTING	53
PIANIST	45
PIANO MODE	28
PIANO STYLIST	47
PITCH BEND RANGE	110
PLAY STYLE	27
POWER	10
PROGRAM CHANGE MODE, MIDI	123
PUNCH RECORD	81

Q

QUANTIZE, COMPOSER	92
QUANTIZE, SEQUENCER	73

R

REALTIME COMMANDS, MIDI	122
REALTIME RECORD	59
RECORD SETTING	90
REVERB	117
RHYTHM GROUP	40
RHYTHM VOLUME	46
RIGHT 1 INPUT, MIDI	124

S

SET	51
SEQUENCER	54
SEQUENCER EDIT	70
SEQUENCER MEDLEY	83
SEQUENCER PLAY	61
SEQUENCER RESET	57, 61
SONG CLEAR	75
SONG SELECT/NAME	56
SOUND SETTING	106
SOUND GROUP	29
Specifications	138
SPLIT POINT	33
Standard MIDI File (SMF)	97
START/STOP	41
STEP RECORD, COMPOSER	93
STEP RECORD, SEQUENCER	63
STEP RECORD: CHORD	65
STEP RECORD: RHYTHM	67
SUSTAIN PEDAL	34, 109
SYNCHRO START	41

T

TAP TEMPO	42
TECHNI-CHORD	39
TECHNI-CHORD OUTPUT, MIDI	125
TECHNI-CHORD TYPE	115
TEMPO/PROGRAM	26, 42
TRACK ASSIGN	69
TRACK CLEAR	75
TRACK MERGE	77
TRANSPOSE	38
Troubleshooting	132
TUNING	110

V

VARIATION	40
VELOCITY CHANGE	74
VOLUME	108
Volume balance	22

Specifications

	SX-PR700/SX-PR700M	SX-PR900R/SX-PR900C/SX-PR900B	
KEYBOARD	88 KEYS		
SOUND GENERATOR	PCM		
MAXIMUM NUMBER OF NOTES PRODUCED SIMULTANEOUSLY	64 NOTES		
PLAY STYLE	PIANO MODE, KEYBOARD SPLIT, AUTO PLAY CHORD		
PIANO	4 SOUNDS: GRAND, UPRIGHT, ELECTRIC, MODERN		
SOUNDS	SOUND GROUP	196 SOUNDS GROUP: PIANO & E PIANO, HARPSI & Mallet, GUITAR, SPECIAL PERC, STRINGS & VOCAL, ORGAN & ACCORDION, BRASS, SAX & REED, FLUTE, SYNTH LEAD, BASS, SYNTH PAD, KEYBOARD PERC, PERC & EFFECT	216 SOUNDS GROUP: PIANO & E PIANO, HARPSI & Mallet, GUITAR, SPECIAL PERC, STRINGS, ORGAN & ACCORDION, VOCAL, SAX, BRASS, REED, FLUTE, SYNTH LEAD, BASS, SYNTH PAD, KEYBOARD PERC, PERC & EFFECT
	DIGITAL DRAWBAR	—	○
CONDUCTOR	RIGHT 1, RIGHT 2, LEFT SELECT		
PEDAL	SUSTAIN, SOSTENUTO, SOFT		
DIGITAL EFFECT	○		
DSP EFFECT	○		
DIGITAL REVERB	○		
BRILLIANCE	○		
TRANPOSE	G-C-F#		
RHYTHMS	128 RHYTHMS × 4 VARIATIONS GROUP: 8 BEAT, ROCK, 16 BEAT, FUNK & FUSION, SOUL & DISCO, TRAD DANCE, BIG BAND & SWING, JAZZ COMBO, COUNTRY, U.S. TRAD, SHOW TIME, MARCH & WALTZ, LATIN 1, LATIN 2		
METRONOME	○		
CONTROLS	MAIN VOLUME, RHYTHM VOLUME, BALANCE/MUTE, START/STOP, INTRO & ENDING 1, INTRO & ENDING 2, FILL IN 1, FILL IN 2, COUNT INTRO, SYNCHRO START, TEMPO/PROGRAM, TAP TEMPO, SPLIT POINT		
AUTO PLAY CHORD	BASIC, ADVANCED 1, ADVANCED 2, PIANIST, ON BASS, MUSIC STYLE ARRANGER		
ONE TOUCH PLAY	○ (ONE TOUCH PLAY/MUSIC STYLE SELECT)		
PIANO STYLIST	○		
TECHNI-CHORD	○		
PANEL MEMORY	2 BANKS (A/B) × 5, SET		
SEQUENCER	16 TRACKS RESOLUTION: 96 PULSES PER QUARTER-NOTE STORAGE CAPACITY: APPROX. 30000 NOTES (10 SONGS MAX.) INPUT MODES: EASY RECORD, REALTIME RECORD, STEP RECORD FUNCTIONS: TRACK ASSIGN, EDIT, SONG SELECT/NAME, PUNCH RECORD, MEDLEY		

	SX-PR700/SX-PR700M	SX-PR900R/SX-PR900C/SX-PR900B
COMPOSER	5 PARTS: BASS, ACCOMP 1, ACCOMP 2, ACCOMP 3, DRUMS STORAGE CAPACITY: APPROX.10000 NOTES INPUT MODES: EASY COMPOSER, REALTIME RECORD, STEP RECORD FUNCTIONS: COMPOSER CHORD MAP, MODE SELECT, PATTERN COPY, LOAD SINGLE COMPOSER PATTERN, SEQ TO COMP COPY, COMPOSER LOAD MEMORY: 3 BANKS × 10 (VARIATION 1-4, INTRO 1, 2, FILLIN 1, 2, ENDING 1, 2)	
MEMORY & CONTROL	INITIAL, DISK LOAD, DISK SAVE, DIRECT PLAY, PEDAL SETTING, FLOPPY DISK FORMAT, MEDLEY, PANEL MEMORY MODE, MUSIC STYLE ARRANGER MODE	
SOUND SETTING	PART SETTING (VOLUME, PAN, EFFECT, SUSTAIN, KEY SHIFT, TUNING, PITCH BEND RANGE, OTHERS), MIXER, OVERALL TOUCH SENSITIVITY, MASTER TUNING, KEY SCALING, TECHNI-CHORD TYPE, LEFT HOLD, REVERB SETTING, DSP EFFECT SETTING	
MIDI	BASIC CHANNEL, CONTROL MESSAGE, OCTAVE SHIFT & LOCAL ON/OFF, REALTIME MESSAGES, COMMON SETTING, MIDI PRESETS, INPUT/OUTPUT SETTING, GENERAL MIDI, P MEM OUTPUT	
EXTERNAL MEMORY	BUILT-IN 3.5 inch FLOPPY DISK DRIVE FOR 2HD (1.44 MB), 2DD (720 KB)	
DISPLAY	LCD (320 × 240 DOTS), PAGE, CONTRAST, EXIT, DISPLAY HOLD	
HELP	○	
DEMO	○	
TERMINALS	PHONES, LINE OUT (R/R+L, L), AUX IN (R/R+L, L), MIDI (IN, OUT, THRU), PEDAL IN	
OUTPUT	60 W × 2	
SPEAKERS	16 cm × 2, 6.5 cm × 2, MONITOR SPEAKER (13 cm × 6 cm) × 2	
POWER REQUIREMENT	280 W, 185 W (NORTH AMERICA AND MEXICO) AC120/220/240V 50/60 Hz AC120V 60 Hz (NORTH AMERICA AND MEXICO) AC230-240V 50/60 Hz (EUROPE, AUSTRALIA, NEW ZEALAND AND PHILIPPINES)	
DIMENSIONS (W × H × D)	139.7 cm × 105 cm × 61.4 cm (55" × 41-11/32" × 24-3/16")	143.3 cm × 104.8 cm × 63.5 cm (56-13/32" × 41-1/4" × 25")
NET WEIGHT	76 kg (167.6 lbs.)	80 kg (176.4 lbs.)
ACCESSORIES	STAND, AC CORD	

- Design and specifications are subject to change without notice.
- In some markets, some models may not be available.

MEMO

SX-PR700 / SX-PR900 REFERENCE GUIDE

Contents

■ DISPLAY GUIDE	2
■ EASY SETTING	2
■ SOUND(PR700)	3
■ SOUND(PR900)	6
■ RHYTHM	9
■ KEYBOARD PERCUSSION	11
■ PIANO STYLIST	13
■ TECHNI-CHORD TYPE	14
■ REVERB	15
■ DSP EFFECT	16
■ MIDI Implementation Chart	20
■ MIDI DATA FORMAT	22

DISPLAY GUIDE

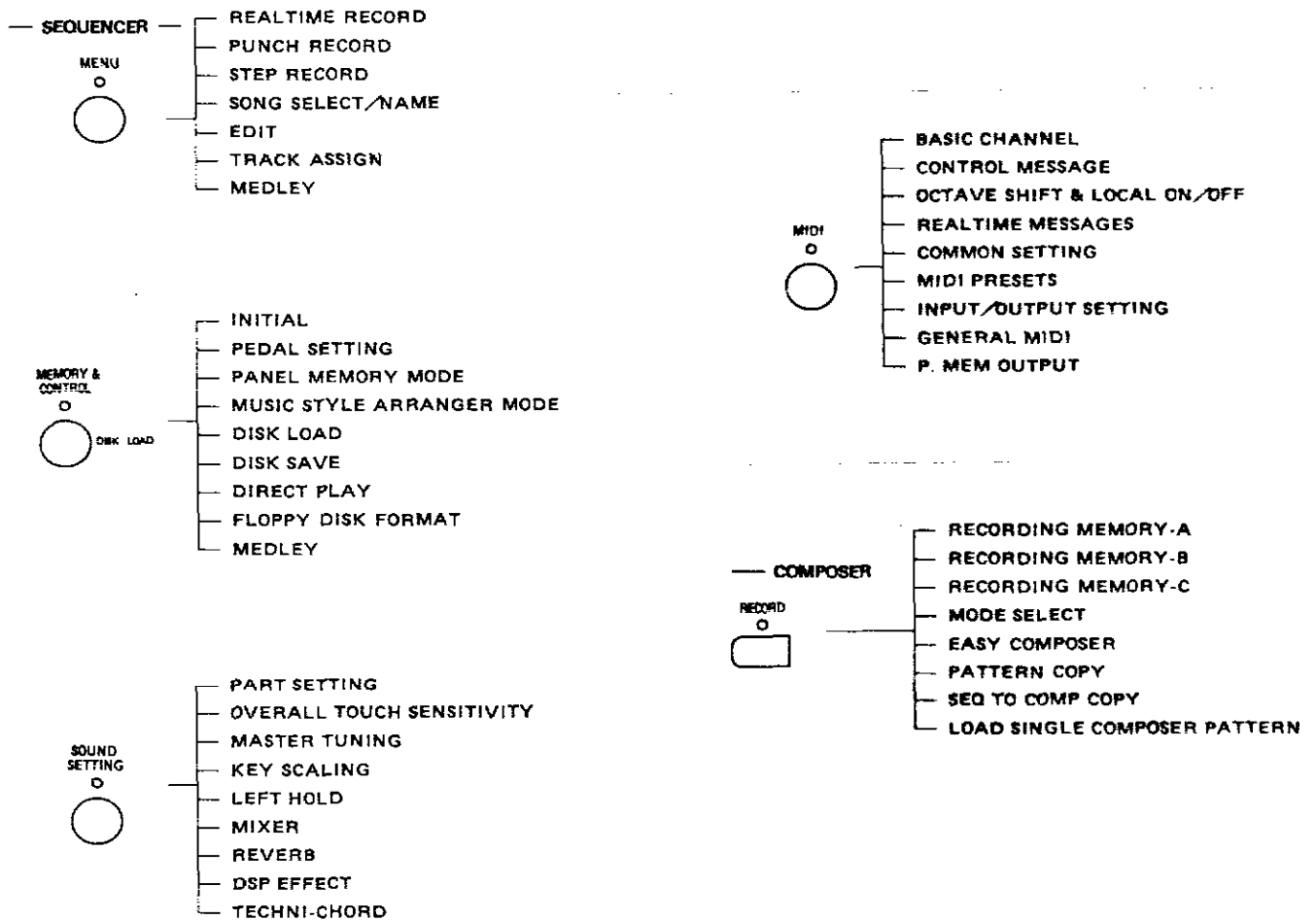

EASY SETTING (Press and hold)

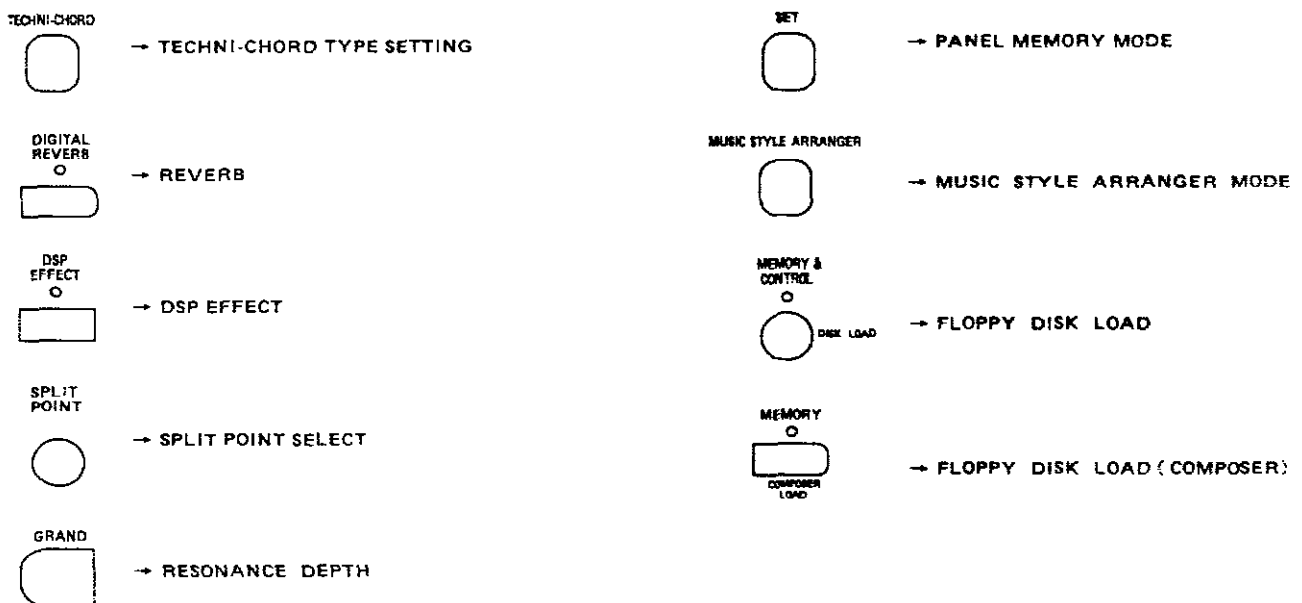

<BUTTON No.>

SOUND GROUP

PIANO & EPIANO	GUITAR	STRINGS & VOCAL	BRASS	FLUTE	BASS	KEYBOARD PERC
11	12	13	14	15	16	17

HARPSI & MALLETT	SPECIAL PERC	ORGAN & ACCORDION	SAX & REED	SYNTH LEAD	SYNTH PAD	PERC & EFFECT
4	5	6	7	8	9	10

GRAND	UPRIGHT	ELECTRIC	MODERN
0	1	2	3

PIANO

SOUND	MIDI PROGRAM CHANGE DATA			SOUND	MIDI PROGRAM CHANGE DATA		
	NORM	TECH	GM		NORM	TECH	GM
GRAND PIANO				UPRIGHT PIANO			
Grand Piano	0 (0)	0 (0)	1	Upright Piano	1 (0)	2 (32)	
ELECTRIC PIANO				MODERN PIANO			
E. Piano 1	2 (0)	4 (32)		Modern E.P.1	3 (0)	6 (0)	6
HARPSI & MALLETT				SPECIAL PERC			
Harpichord	4 (0)	16 (0)	7	Hawaiian Gtr 1	5 (0)	31 (48)	
Clavi	4 (1)	17 (0)	8	Hawaiian Gtr 2	5 (1)	31 (0)	
Glockenspiel	4 (2)	9 (0)	10	Banjo	5 (2)	33 (0)	106
Vibraphone	4 (3)	8 (0)	12	Mandolin	5 (3)	35 (0)	
Marimba	4 (4)	10 (0)	13	Harp	5 (4)	32 (0)	47
Xylophone	4 (5)	11 (0)	14	Orchestra Hit	5 (5)	127 (16)	56
Celesta	4 (6)	12 (0)	9	Timpani	5 (6)	126 (0)	48
Steel Drum	4 (7)	15 (0)	115	Music Box	5 (7)	7 (0)	11
Tubular Bells	4 (8)	14 (0)	15	Koto	5 (8)	37 (0)	108
Tinkle Bell	4 (9)	14 (32)	113	Kalimba	5 (9)	39 (0)	109
Cembalo	4 (10)	18 (0)		Shamisen	5 (10)	36 (0)	107
Vibes & JzGtr	4 (11)	8 (64)		Sitar	5 (11)	38 (0)	105
				Dulcimer	5 (12)	38 (16)	16
ORGAN & ACCORDION				SAX & REED			
Jazz Organ	6 (0)	88 (0)	18	Soprano Sax	7 (0)	76 (0)	65
Full Drawbars	6 (1)	89 (0)	17	Alto Sax	7 (1)	77 (0)	66
Jazz Drawbars	6 (2)	93 (0)		Mellow Alto	7 (2)	77 (16)	
16' & 1'	6 (3)	91 (0)		Tenor Sax	7 (3)	78 (48)	67
Pop Organ	6 (4)	90 (0)		Breathy Tenor	7 (4)	78 (16)	
Pipe Organ 1	6 (5)	84 (0)	20	Baritone Sax	7 (5)	79 (16)	68
Pipe Organ 2	6 (6)	85 (0)		Jz Clarinet 1	7 (6)	68 (0)	72
Theatre Org 1	6 (7)	87 (32)		Clas Clarinet	7 (7)	69 (0)	
Brt Accordion	6 (8)	80 (0)	22	Oboe	7 (8)	66 (0)	69
Musette	6 (9)	82 (0)		Harmonica	7 (9)	83 (0)	23
Mlw Drawbars	6 (10)	91 (32)		Unison Sexes	7 (10)	79 (32)	
Rock Organ	6 (11)	92 (32)	19	Jz Clarinet 2	7 (11)	68 (32)	
Theatre Org 2	6 (12)	87 (48)		Mlw Clarinet	7 (12)	68 (16)	
Harmonium	6 (13)	86 (32)	21	English Horn	7 (13)	67 (0)	70
Mlw Accordion	6 (14)	81 (0)		Bassoon	7 (14)	70 (0)	71
Bandceon	6 (15)	80 (16)	24	Bagpipe	7 (15)	73 (0)	110
				Shanai	7 (16)	73 (16)	112

SOUND

(PR700)

SOUND	MIDI PROGRAM CHANGE DATA			SOUND	MIDI PROGRAM CHANGE DATA		
	NORM	TECH	GM		NORM	TECH	GM
SYNTH LEAD				SYNTH PAD			
Square Lead	8 (0)	117 (0)	81	Mlw Ensemble	9 (0)	107 (16)	90
Saw Lead	8 (1)	118 (16)	82	Warm Syn Pad	9 (1)	62 (80)	
Sine Lead	8 (2)	94 (0)		Synth Vocal	9 (2)	107 (0)	55
Air Vox	8 (3)	106 (16)	86	Spacy Pad	9 (3)	107 (32)	92
Chiffer Lead	8 (4)	117 (32)	84	Star Theme	9 (4)	120 (16)	104
Charang	8 (5)	27 (48)	85	Bowed Glass	9 (5)	120 (0)	93
5th Wave	8 (6)	119 (0)	87	Atmosphere	9 (6)	21 (48)	100
Bass&Lead	8 (7)	46 (32)	88	Fantasia	9 (7)	116 (48)	89
Synth Harp	8 (8)	32 (64)		Mist	9 (8)	108 (48)	101
Crystal	8 (9)	9 (32)	99	Sweep Pad	9 (9)	62 (32)	96
				Dream	9 (10)	108 (32)	
				Metal Pad	9 (11)	106 (32)	94
				Halo Pad	9 (12)	107 (48)	95
				Echo Drops	9 (13)	106 (48)	103
				Poly Synth	9 (14)	102 (32)	91
PERC & EFFECT				PIANO & E.PIANO			
Ice Rain	10 (0)	121 (48)	97	Bright Piano	11 (0)	1 (0)	2
Soundtrack	10 (1)	119 (16)	98	Piano 1 Oct	11 (1)	0 (16)	
Goblins	10 (2)	106 (0)	102	Piano 2 Oct	11 (2)	2 (16)	
Agogo	10 (3)	122 (0)	114	Rock Piano	11 (3)	3 (32)	
Wood Block	10 (4)	122 (16)	116	Honky Tonk	11 (4)	1 (16)	4
Taiko Drum	10 (5)	123 (48)	117	Elect Grand	11 (5)	3 (0)	3
Melodic Tom	10 (6)	122 (32)	118	Midi Grand	11 (6)	0 (32)	
Synth Drum	10 (7)	124 (0)	119	E. Piano 2	11 (7)	5 (0)	5
Rev Cymbal	10 (8)	122 (48)	120	Tremolo EP	11 (8)	4 (64)	
Applause	10 (9)	125 (48)	127	Modern E.P.2	11 (9)	4 (0)	
Fret Noise	10 (10)	124 (16)	121	Mellow Piano	11 (10)	2 (0)	
Breath Noise	10 (11)	124 (32)	122	Modern E.P.3	11 (11)	6 (48)	
Seashore	10 (12)	124 (48)	123				
Bird Tweet	10 (13)	125 (32)	124				
Telephone	10 (14)	123 (0)	125				
Helicopter	10 (15)	123 (16)	126				
Gun Shot	10 (16)	123 (32)	128				
GUITAR				STRINGS & VOCAL			
Classic Gtr	12 (0)	20 (0)		Symph Strings	13 (0)	100 (48)	
Spanish Gtr	12 (1)	20 (16)		Clas Strings	13 (1)	100 (0)	49
Folk Guitar	12 (2)	22 (0)	26	Soft Strings	13 (2)	101 (32)	
Jazz Guitar	12 (3)	25 (0)	27	Pizzicato Str	13 (3)	99 (0)	46
Bright Solid	12 (4)	26 (0)	28	Violin	13 (4)	96 (0)	41
Mellow Solid	12 (5)	28 (0)		Viola	13 (5)	97 (32)	42
Mute Guitar	12 (6)	28 (0)	29	Cello	13 (6)	97 (0)	43
Dist Guitar	12 (7)	30 (0)	31	Vocal Ah	13 (7)	104 (48)	53
Overdrive Gtr	12 (8)	27 (32)	30	Vocal Ooh	13 (8)	104 (32)	
Country Gtr	12 (9)	31 (16)		Vocal Doo	13 (9)	109 (0)	54
12 String Gt	12 (10)	23 (0)		Marcato	13 (10)	100 (64)	
Electro Ac Gtr	12 (11)	25 (32)		Slow Strings	13 (11)	101 (0)	50
Rock Harmonic	12 (12)	27 (16)		Oct Strings	13 (12)	102 (0)	
				Bass Strings	13 (13)	98 (16)	
				Tremolo Str	13 (14)	100 (32)	45
				Syn String 1	13 (15)	103 (0)	51
				Syn String 2	13 (16)	103 (16)	52
				Cntry Fiddle	13 (17)	98 (32)	111
				Bowed Bass	13 (18)	98 (0)	44

SOUND

(PR700)

SOUND	MIDI PROGRAM CHANGE DATA			SOUND	MIDI PROGRAM CHANGE DATA		
	NORM	TECH	GM		NORM	TECH	GM
BRASS				FLUTE			
Brass	14 (0)	56 (0)	62	Piccolo	15 (0)	64 (0)	73
Brass & Synth	14 (1)	56 (48)		Jazz Flute	15 (1)	65 (0)	74
Synth Brass 1	14 (2)	60 (0)	63	Clas Flute	15 (2)	65 (16)	
Trumpet	14 (3)	48 (0)	57	Alto Flute	15 (3)	64 (16)	
Solo T-umpet	14 (4)	48 (64)		Pan Flute	15 (4)	72 (0)	76
Mute Trumpet	14 (5)	50 (0)	60	Recorder	15 (5)	74 (0)	75
Flugel Horn	14 (6)	51 (0)		Ocarina	15 (6)	74 (16)	80
Brt Trombone	14 (7)	52 (0)	58	Whistle	15 (7)	111 (0)	79
Clsd Fr. Horn	14 (8)	54 (0)		Shakuhachi	15 (8)	75 (0)	78
Open Fr. Horn	14 (9)	54 (16)	61	Alto Ensemble	15 (9)	64 (48)	
Octave Brass	14 (10)	56 (16)		Syn Calliope	15 (10)	72 (48)	83
Synth Brass 2	14 (11)	63 (48)		Blown Bottle	15 (11)	72 (32)	77
Synth Brass 3	14 (12)	63 (64)	64				
Milw Trombone	14 (13)	53 (0)					
Mute Trombone	14 (14)	52 (48)					
Marching Tuba	14 (15)	55 (16)	59				
BASS				KEYBOARD PERC			
Acoustic Bass	16 (0)	43 (0)	33	Jazz Kit	17 (0)	113 (128)	
Milw Ac Bass	16 (1)	43 (16)		Brush Kit	17 (1)	117 (128)	
Elect Bass	16 (2)	40 (0)		Trad Kit	17 (2)	118 (128)	
Bright Bass	16 (3)	40 (16)	34	Standard Kit	17 (3)	112 (128)	
Fretless Bass	16 (4)	40 (32)	36	Room Kit	17 (4)	115 (128)	
Picked Bass	16 (5)	42 (0)	35	Light Rock Kit	17 (5)	126 (128)	
Slap Bass 1	16 (6)	41 (0)	37	Power Kit	17 (6)	119 (128)	
Analog Bass	16 (7)	46 (16)		Soul Kit	17 (7)	121 (128)	
Soul Bass	16 (8)	42 (16)		Electric Kit	17 (8)	114 (128)	
Wow Bass	16 (9)	46 (0)	39	Orch Kit	17 (9)	124 (128)	
Fusion Bass	16 (10)	40 (64)					
Mute Bass	16 (11)	47 (0)					
Slap Bass 2	16 (12)	41 (16)	38				
Plastic Bass	16 (13)	46 (80)	40				

•The numbers in parentheses () are bank data.

Program change number = Program change data + 1 / Bank number = Bank data + 1

SOUND

(PR900)

<BUTTON No.>

SOUND GROUP

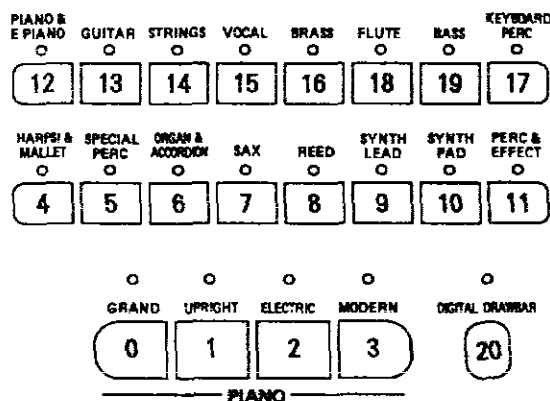

SOUND	MIDI PROGRAM CHANGE DATA			SOUND	MIDI PROGRAM CHANGE DATA		
	NORM	TECH	GM		NORM	TECH	GM
GRAND PIANO				UPRIGHT PIANO			
Grand Piano	0 (0)	0 (0)	1	Upright Piano	1 (0)	2 (32)	
ELECTRIC PIANO				MODERN PIANO			
E.Piano 1	2 (0)	4 (32)		Modern E.P.1	3 (0)	6 (0)	6
HARPSI & MALLET				SPECIAL PERC			
Harpsichord	4 (0)	16 (0)	7	Hawaiian Gtr 1	5 (0)	31 (48)	
Clavi	4 (1)	17 (0)	8	Hawaiian Gtr 2	5 (1)	31 (0)	
Glockenspiel	4 (2)	9 (0)	10	Banjo	5 (2)	33 (0)	108
Vibraphone	4 (3)	8 (0)	12	Mandolin	5 (3)	35 (0)	
Marimba	4 (4)	10 (0)	13	Harp	5 (4)	32 (0)	47
Xylophone	4 (5)	11 (0)	14	Orchestra Hit	5 (5)	127 (16)	56
Celesta	4 (6)	12 (0)	9	Timpani	5 (6)	126 (0)	48
Steel Drum	4 (7)	15 (0)	115	Music Box	5 (7)	7 (0)	11
Tubular Bells	4 (8)	14 (0)	15	Koto	5 (8)	37 (0)	108
Tinkle Bell	4 (9)	14 (32)	113	Kalimba	5 (9)	39 (0)	109
Cembalo	4 (10)	18 (0)		Shamisen	5 (10)	36 (0)	107
Vibes & JzGtr	4 (11)	8 (64)		Metal Kalimba	5 (11)	38 (18)	
Btle Marimba	4 (12)	13 (0)		Sitar	5 (12)	38 (0)	105
Africa Mallet	4 (13)	113 (0)		Gamelan	5 (13)	14 (48)	
Carib Mallet	4 (14)	11 (16)		Dulcimer	5 (14)	38 (16)	16
ORGAN & ACCORDION				SAX			
Jazz Organ	6 (0)	88 (0)	18	Soprano Sax	7 (0)	76 (0)	65
Full Drawbars	6 (1)	89 (0)	17	Alto Sax	7 (1)	77 (0)	66
Jazz Drawbars	6 (2)	93 (0)		Mellow Alto	7 (2)	77 (16)	
18' & 1'	6 (3)	91 (0)		Tenor Sax	7 (3)	78 (48)	67
Pop Organ	6 (4)	90 (0)		Breathy Tenor	7 (4)	78 (16)	
Pipe Organ 1	6 (5)	84 (0)	20	Rock Tenor	7 (5)	79 (0)	
Pipe Organ 2	6 (6)	85 (0)		Baritone Sax	7 (6)	79 (16)	68
Theatre Org 1	6 (7)	87 (32)		Dist Sax	7 (7)	78 (32)	
Brt Accordion	6 (8)	80 (0)	22	Unison Saxes	7 (8)	79 (32)	
Musette	6 (9)	82 (0)		Synth Sax	7 (9)	79 (48)	
Mlw Drawbars	6 (10)	91 (32)					
Rock Organ	6 (11)	92 (32)	19				
Theatre Org 2	6 (12)	87 (48)					
Harmonium	6 (13)	86 (32)	21				
Mlw Accordion	6 (14)	81 (0)					
Bandoneon	6 (15)	80 (16)	24				

SOUND

(PR900)

SOUND	MIDI PROGRAM CHANGE DATA			SOUND	MIDI PROGRAM CHANGE DATA		
	NORM	TECH	GM		NORM	TECH	GM
REED				SYNTH LEAD			
Jz Clarinet 1	8 (0)	68 (0)	72	Square Lead	9 (0)	117 (0)	81
Jz Clarinet 2	8 (1)	68 (32)		Saw Lead	9 (1)	118 (16)	82
Mlw Clarinet	8 (2)	68 (16)		Sine Lead	9 (2)	94 (0)	
Clas Clarinet	8 (3)	69 (0)		Chiffer Lead	9 (3)	117 (32)	84
Bass Clarinet	8 (4)	69 (16)		Charang	9 (4)	27 (48)	85
Oboe	8 (5)	66 (0)	69	Olymp Synth	9 (5)	60 (64)	
English Horn	8 (6)	67 (0)	70	5th Wave	9 (6)	119 (0)	87
Bassoon	8 (7)	70 (0)	71	Bass&Lead	9 (7)	46 (32)	88
Harmonica	8 (8)	83 (0)	23	Synth Harp	9 (8)	32 (64)	
Blues Harm	8 (9)	83 (16)		Crystal	9 (9)	9 (32)	99
Bagpipe	8 (10)	73 (0)	110				
Shana	8 (11)	73 (16)	112				
SYNTH PAD				PERC & EFFECT			
Warm Syn Pad	10 (0)	62 (80)		Ice Rain	11 (0)	121 (48)	97
Spacy Pad	10 (1)	107 (32)	92	Soundtrack	11 (1)	119 (16)	98
Star Theme	10 (2)	120 (16)	104	Goblins	11 (2)	106 (0)	102
Bowed Glass	10 (3)	120 (0)	93	Agogo	11 (3)	122 (0)	114
Atmosphere	10 (4)	21 (48)	100	Wood Block	11 (4)	122 (16)	116
Fantasia	10 (5)	116 (48)	89	Taiko Drum	11 (5)	123 (48)	117
Dream	10 (6)	108 (32)		Melodic Tom	11 (6)	122 (32)	118
Mist	10 (7)	108 (48)	101	Synth Drum	11 (7)	124 (0)	119
Sweep Pad	10 (8)	62 (32)	96	Rev Cymbal	11 (8)	122 (48)	120
Poly Synth	10 (9)	102 (32)	91	Applause	11 (9)	125 (48)	127
Metal Pad	10 (10)	106 (32)	94	Fret Noise	11 (10)	124 (16)	121
Halo Pad	10 (11)	107 (48)	95	Breath Noise	11 (11)	124 (32)	122
				Seashore	11 (12)	124 (48)	123
				Bird Tweet	11 (13)	125 (32)	124
				Telephone	11 (14)	123 (0)	125
				Helicopter	11 (15)	123 (16)	126
				Gun Shot	11 (16)	123 (32)	128
PIANO & E.PIANO				GUITAR			
Bright Piano	12 (0)	1 (0)	2	Classic Gtr	13 (0)	20 (0)	
Piano 1 Oct	12 (1)	0 (16)		Spanish Gtr	13 (1)	20 (16)	
Piano 2 Oct	12 (2)	2 (16)		Folk Guitar	13 (2)	22 (0)	26
Rock Piano	12 (3)	3 (32)		Jazz Guitar	13 (3)	25 (0)	27
Honky Tonk	12 (4)	1 (16)	4	Bright Solid	13 (4)	26 (0)	28
Elect Grand	12 (5)	3 (0)	3	Mellow Solid	13 (5)	28 (0)	
Midi Grand	12 (6)	0 (32)		Mute Guitar	13 (6)	29 (0)	29
E.Piano 2	12 (7)	5 (0)	5	Dist Guitar	13 (7)	30 (0)	31
Tremolo EP	12 (8)	4 (64)		Overdrive Gtr	13 (8)	27 (32)	30
Modern E.P.2	12 (9)	4 (0)		Country Gtr	13 (9)	31 (16)	
Mellow Piano	12 (10)	2 (0)		Jazz Ac Gtr	13 (10)	21 (0)	25
Modern E.P.3	12 (11)	6 (48)		Harmonics	13 (11)	27 (64)	
				12 String Gt	13 (12)	23 (0)	
				Electro Ac Gtr	13 (13)	25 (32)	
				Clean Solid	13 (14)	26 (16)	
				Rock Harmonic	13 (15)	27 (16)	

SOUND

(PR900)

SOUND	MIDI PROGRAM CHANGE DATA			SOUND	MIDI PROGRAM CHANGE DATA		
	NORM	TECH	GM		NORM	TECH	GM
STRINGS				VOCAL			
Symph Strings	14 (0)	100 (48)		Vocal Ah	15 (0)	104 (48)	53
Clas Strings	14 (1)	100 (0)	49	Pop Vocal Ah	15 (1)	104 (0)	
Marcato	14 (2)	100 (64)		Stereo Vocal	15 (2)	104 (64)	
Soft Strings	14 (3)	101 (32)		Vocal Ooh	15 (3)	104 (32)	
Oct Strings	14 (4)	102 (0)		Humming	15 (4)	105 (0)	
Pizzicato Str	14 (5)	99 (0)	46	Vocal Doo	15 (5)	109 (0)	54
Violin	14 (6)	96 (0)	41	Air Vox	15 (6)	106 (16)	86
Viola	14 (7)	97 (32)	42	Mlw Ensemble	15 (7)	107 (16)	90
Cello	14 (8)	97 (0)	43	Synth Vocal	15 (8)	107 (0)	55
Bowed Bass	14 (9)	96 (0)	44	Echo Drops	15 (9)	106 (48)	103
Slow Strings	14 (10)	101 (0)	50				
Bass Strings	14 (11)	98 (16)					
Tremolo Str	14 (12)	100 (32)	45				
Syn String 1	14 (13)	103 (0)	51				
Syn String 2	14 (14)	103 (16)	52				
Jazz Violin	14 (15)	96 (16)					
Cntry Fiddle	14 (16)	96 (32)	111				
BRASS				KEYBOARD PERC			
Brass	16 (0)	56 (0)	62	Jazz Kit	17 (0)	113 (128)	
Brass & Synth	16 (1)	56 (48)		Brush Kit	17 (1)	117 (128)	
Synth Brass 1	16 (2)	60 (0)	63	Trad Kit	17 (2)	118 (128)	
Trumpet	16 (3)	48 (0)	57	Standard Kit	17 (3)	112 (128)	
Solo Trumpet	16 (4)	48 (64)		Room Kit	17 (4)	115 (128)	
Mute Trumpet	16 (5)	50 (0)	60	Light Rock Kit	17 (5)	126 (128)	
Flugel Horn	16 (6)	51 (0)		Power Kit	17 (6)	119 (128)	
Brt Trombone	16 (7)	52 (0)	58	Soul Kit	17 (7)	121 (128)	
Clad Fr. Horn	16 (8)	54 (0)		Electric Kit	17 (8)	114 (128)	
Open Fr. Horn	16 (9)	54 (16)	61	Orch Kit	17 (9)	124 (128)	
Octave Brass	16 (10)	56 (16)					
Synth Brass 2	16 (11)	63 (48)					
Synth Brass 3	16 (12)	63 (64)	64				
Orch Trumpet	16 (13)	48 (32)					
Mlw Trombone	16 (14)	53 (0)					
Mute Trombone	16 (15)	52 (48)					
Marching Tuba	16 (16)	55 (16)	59				
FLUTE				BASS			
Piccolo	18 (0)	64 (0)	73	Acoustic Bass	19 (0)	43 (0)	33
Jazz Flute	18 (1)	65 (0)	74	Mlw Ac Bass	19 (1)	43 (16)	
Clas Flute	18 (2)	65 (16)		Elect Bass	19 (2)	40 (0)	
Alto Flute	18 (3)	64 (16)		Bright Bass	19 (3)	40 (16)	34
Pan Flute	18 (4)	72 (0)	76	Fretless Bass	19 (4)	40 (32)	36
Recorder	18 (5)	74 (0)	75	Picked Bass	19 (5)	42 (0)	35
Ocarina	18 (6)	74 (16)	80	Slap Bass 1	19 (6)	41 (0)	37
Whistle	18 (7)	111 (0)	79	Analog Bass	19 (7)	46 (16)	
Shakuhachi	18 (8)	75 (0)	78	Soul Bass	19 (8)	42 (16)	
Alto Ensemble	18 (9)	64 (48)		Wow Bass	19 (9)	46 (0)	39
Syn Calliope	18 (10)	72 (48)	83	Fusion Bass	19 (10)	40 (64)	
Blown Bottle	18 (11)	72 (32)	77	Funky E. Bass	19 (11)	40 (48)	
				Mute Bass	19 (12)	47 (0)	
				Slap Bass 2	19 (13)	41 (16)	38
				Plastic Bass	19 (14)	46 (80)	40
DIGITAL DRAWBAR							
Drawbars	20 (0)	0 (240)					

*The numbers in parentheses () are bank data.

Program change number = Program change data + 1 / Bank number = Bank data + 1

RHYTHM

RHYTHM	MIDI PROGRAM CHANGE DATA		RHYTHM	MIDI PROGRAM CHANGE DATA	
	NORM	TECH		NORM	TECH
ROCK			FUNK & FUSION		
Rock'n' Roll	0 (0)	80 (64)	Funk	1 (0)	110 (48)
Piano R&Roll	0 (1)	80 (96)	Swingy Funk	1 (1)	65 (32)
Twist	0 (2)	76 (32)	Jazz Funk 1	1 (2)	112 (48)
Shuffle R&R	0 (3)	76 (16)	Jazz Funk 2	1 (3)	113 (64)
Sfuffl Boogie	0 (4)	76 (0)	Carib. Rock	1 (4)	118 (48)
Shuffl Ballad	0 (5)	78 (32)	Jazz Rock 1	1 (5)	113 (96)
Rock Ballad	0 (6)	74 (80)	Jazz Rock 2	1 (6)	113 (80)
R&B Ballad	0 (7)	75 (64)	Samba Rock 1	1 (7)	116 (48)
Rhythm & Blues	0 (8)	123 (80)	Samba Rock 2	1 (8)	117 (16)
Hard Rock	0 (9)	92 (32)	Salsa Piano	1 (9)	68 (64)
TRAD DANCE			JAZZ COMBO		
Ballroom Fox	2 (0)	29 (16)	Jazz Combo	3 (0)	34 (80)
Quick Fox	2 (1)	29 (48)	Euro Combo	3 (1)	34 (64)
Euro Fox	2 (2)	29 (32)	Jazz Quartet	3 (2)	32 (64)
Paris Ballad	2 (3)	74 (96)	Jazz Quintet	3 (3)	34 (96)
Chanson Fox	2 (4)	29 (64)	Jazz Ballad	3 (4)	44 (16)
Quickstep	2 (5)	28 (16)	Lounge Piano	3 (5)	44 (32)
Jive	2 (6)	29 (0)	Jazz Trio	3 (6)	32 (80)
Roaring 20's	2 (7)	24 (112)	BoogieWoogie	3 (7)	31 (0)
			Modern Jazz	3 (8)	40 (80)
U.S. TRAD			MARCH & WALTZ		
Hawaiian	4 (0)	22 (16)	US March 2/4	5 (0)	0 (80)
DixiePianist	4 (1)	24 (0)	Grmn March 2/4	5 (1)	1 (48)
Dixie Band	4 (2)	24 (96)	US March 6/8	5 (2)	2 (16)
Slow Ragtime	4 (3)	27 (16)	Pop March	5 (3)	4 (64)
Fast Ragtime	4 (4)	27 (0)	Polka 2/4	5 (4)	4 (32)
Gospel Shuffl	4 (5)	77 (64)	Waltz	5 (5)	8 (112)
Gospel Ballad	4 (6)	75 (112)	Ballroom 3/4	5 (6)	13 (32)
Gospel 4/4	4 (7)	77 (96)	ChansonWaltz	5 (7)	11 (32)
Gospel 3/4	4 (8)	19 (16)	Vienna Waltz	5 (8)	9 (32)
Slow Blues	4 (9)	75 (32)			
LATIN 2			8BEAT		
Bassanova 1	6 (0)	48 (0)	8Bt Standard	7 (0)	90 (0)
Bossanova 2	6 (1)	48 (112)	8 Beat Rock	7 (1)	90 (112)
Piano Bossa	6 (2)	48 (16)	8Bt Ballad	7 (2)	91 (32)
Samba	6 (3)	51 (96)	8Bt Pop Ballad	7 (3)	91 (64)
Merengue	6 (4)	67 (16)	8 Beat Pop	7 (4)	84 (64)
Tango Piano	6 (5)	53 (80)	70's Piano Rock	7 (5)	84 (96)
Tango Argent	6 (6)	53 (48)	60's Pop	7 (6)	86 (48)
Tango Europe	6 (7)	53 (64)	Piano Pop	7 (7)	99 (32)
Keroncong	6 (8)	60 (80)			
Dangdut	6 (9)	60 (64)			















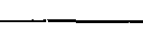

RHYTHM

RHYTHM	MIDI PROGRAM CHANGE DATA		RHYTHM	MIDI PROGRAM CHANGE DATA	
	NORM	TECH		NORM	TECH
16BEAT			SOUL & DISCO		
16 Beat 1	8 (0)	96 (96)	Soul	9 (0)	81 (32)
16 Beat 2	8 (1)	96 (64)	8 Beat Soul	9 (1)	87 (16)
16Bt Ballad1	8 (2)	99 (16)	Soul Shuffle	9 (2)	77 (80)
16Bt Ballad2	8 (3)	99 (112)	Soul Rock	9 (3)	102 (64)
E.P. Ballad	8 (4)	99 (0)	Soul Ballad	9 (4)	75 (0)
16 PopBallad	8 (5)	107 (80)	16 Beat Soul	9 (5)	103 (32)
H.Rock Ballad	8 (6)	100 (32)	Euro Disco	9 (6)	124 (112)
Swing Rock 1	8 (7)	72 (80)	Disco Samba	9 (7)	120 (64)
Swing Rock 2	8 (8)	72 (64)	Dance	9 (8)	124 (96)
			House	9 (9)	125 (32)
BIG BAND & SWING			COUNTRY		
Swing Combo	10 (0)	25 (32)	Country2step	11 (0)	17 (112)
BigBand Fast	10 (1)	36 (64)	Country Piano	11 (1)	75 (48)
BigBand Mid	10 (2)	38 (80)	Country Swing	11 (2)	17 (80)
Dance Band	10 (3)	39 (48)	Bluegrass	11 (3)	20 (48)
BigBand slow	10 (4)	38 (112)	Saloon Bar	11 (4)	21 (16)
Orch.Swing	10 (5)	37 (32)	Country Pop	11 (5)	85 (48)
Jazz Waltz1	10 (6)	46 (48)	Country Rock1	11 (6)	85 (64)
Jazz Waltz2	10 (7)	46 (64)	Country Rock2	11 (7)	85 (32)
Swingy Waltz	10 (8)	12 (16)	Country Rock3	11 (8)	18 (16)
SHOW TIME			LATIN 1		
Broadway Show	12 (0)	15 (32)	Rhumba	13 (0)	58 (64)
Hollywood	12 (1)	30 (16)	Rumba Pianist	13 (1)	58 (80)
Soft Shoe	12 (2)	24 (80)	Beguine	13 (2)	59 (32)
Cabaret	12 (3)	15 (48)	Belero	13 (3)	58 (32)
Vagas Pianist	12 (4)	74 (112)	Cha Cha	13 (4)	57 (48)
Broadway Strd	12 (5)	30 (32)	Mambo	13 (5)	56 (64)
PianoShowman	12 (6)	28 (32)	Modern Mambo	13 (6)	56 (32)
			Carib	13 (7)	118 (64)
			Swing Reggae	13 (8)	71 (32)
			Modern Reggae	13 (9)	71 (48)
METRONOME					
Metronome Off	14 (0)	6 (32)			
Metronome 2/4	14 (1)	6 (48)			
Metronome 3/4	14 (2)	7 (0)			
Metronome 4/4	14 (3)	6 (0)			
Metronome 5/4	14 (4)	6 (16)			
Metronome 6/4	14 (5)	7 (16)			
Metronome 6/8	14 (6)	7 (32)			

*The numbers in parentheses () are bank data.















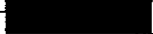













































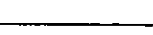







Program change number = Program change data+1 / Bank number = Bank data+1

KEYBOARD PERCUSSION

		Other kits	MIDI NOTE NUMBER		Orchestral kit	MIDI NOTE NUMBER	
			NORM	TECH		NORM	TECH
		—	—	—	—	—	—
		Bass Drum	36	36	Orchestral Bass Drum	36	36
		Rim Shot	37	47	Rim Shot	37	47
		Snare Drum 1	38	38	Orchestral Snare Drum 1	38	38
		Special Snare Drum	39	31	Castanets	39	55
		Snare Drum 2	40	32	Orchestral Snare Drum 2	40	32
		Floor Tom	41	95	Triangle	41	57
		Splash Cymbal	42	24	Cymbal Soft Mallet	42	24
		Tom Low	43	41	Orchestral Tambourine	43	21
		Crash Cymbal Low	44	51	Orchestral Cymbal 1	44	51
		Tom Mid	45	43	Tam-Tam	45	30
		Crash Cymbal High	46	25	Orchestral Cymbal 2	46	25
		Tom High	47	45	Rattle	47	58
		Hi Hat Close 1	48	48	Tublar Bells C	48	84
		Hi Hat Close 2	49	49	Tublar Bells C ⁺	49	85
		Hi Hat Open	50	50	Tublar Bells D	50	86
		Ride Bell	51	28	Tublar Bells D ⁺	51	87
		Ride Cymbal	52	52	Tublar Bells E	52	88
		Conga Low	53	53	Tublar Bells F	53	89
		Small Conga Low	54	54	Tublar Bells F ⁺	54	90
		Conga High	55	55	Tublar Bells G	55	91
		Small Conga High	56	56	Tublar Bells G ⁺	56	92
		Conga Crash	57	57	Tublar Bells A	57	93
		Metal Cabasa	58	58	Tublar Bells A ⁺	58	94
		Timbales Low	59	99	Tublar Bells B	59	95
		Timbales High	60	100	Tublar Bells c	60	96
		Cowbell Low	61	66	Tublar Bells c ⁺	61	97
		Cowbell High	62	62	Tublar Bells d	62	98
		Agogo Low	63	102	Tublar Bells d ⁺	63	99
		Agogo High	64	101	Timpani E	64	64
		Samba Whistle Low	65	65	Timpani F	65	65
		Samba Whistle High	66	66	Timpani F ⁺	66	66
		Claves	67	67	Timpani G	67	67
		Slap	68	68	Timpani G ⁺	68	68
		Hand Claps	69	69	Timpani A	69	69
		Tambourine	70	74	Timpani A ⁺	70	70
		Shaker	71	96	Timpani B	71	71
		Triangle Mute	72	108	Timpani c	72	72
		Maracas	73	105	Timpani c ⁺	73	73
		Triangle Open	74	107	Timpani d	74	74
		Guiro Short	75	77	Timpani d ⁺	75	75
		Guiro Long	76	76	Timpani e	76	76
		Orchestral Bass Drum	77	85	Timpani f	77	77
		Orchestral Snare Drum	78	86	Wood Block Low	78	115
		Orchestral Cymbal	79	87	Wood Block Mid	79	116
		Wind Chime	80	29	Wood Block High	80	117
		—	—	—	—	—	—
		—	—	—	—	—	—
		—	—	—	—	—	—

* Sounds in SEQUENCER and MIDI function.

KEYBOARD PERCUSSION

		General MIDI	MIDI NOTE NUMBER
		Bass Drum 2*	35
		Bass Drum 1	36
		Rim Shot	37
		Snare Drum 1	38
		Hand Claps	39
		Snare Drum 2	40
		Floor Tom Low	41
		Hi Hat Close	42
		Floor Tom High	43
		Hi Hat Pedal	44
		Tom Low	45
		Hi Hat Open	46
		Tom Mid	47
		Tom High 1	48
		Crash Cymbal 1	49
		Tom High 2	50
		Ride Cymbal 1	51
		China Cymbal	52
		Ride Bell	53
		Tambourine	54
		Splash Cymbal	55
		Cowbell	56
		Crash Cymbal 2	57
		Vibraslap	58
		Ride Cymbal 2	59
		Bongo High	60
		Bongo Low	61
		Conga Mute Crash	62
		Conga High	63
		Conga Low	64
		Timbales High	65
		Timbales Low	66
		Agogo High	67
		Agogo Low	68
		Cabasa	69
		Maracas	70
		Samba Whistle Short	71
		Samba Whistle Long	72
		Guiro Short	73
		Guiro Long	74
		Claves	75
		Wood Block Mid	76
		Wood Block Low	77
		Cuica High	78
		Cuica Low	79
		Triangle Mute	80
		Triangle Mute *	81
		Shaker *	82
		Sleigh Bell *	83

* Sounds in SEQUENCER and MIDI function.

PIANO STYLIST

Rock & Pop	Jazz	Ragtime
Piano R & Roll	Jazz Quintet	Slow Ragtime
01 JERRY LEE'S SOLO	01 MELLOW QUINTET	01 SYNCOPATION
02 LET'S ROCK	02 PIANO & BASS	02 PIANO ROLL RAG
03 50'S BAND	03 SHEER CLASS	03 ENTERTAINING RAG
04 UP TO DATE	04 GOOD VIBES	04 PLAY THE STING
70's Piano Rock	Jazz Trio	Fast Ragtime
05 CROCODILE BEAT	05 OSCAR'S EVENT	05 JOPLIN MOOD
06 ELTON'S ROCK	06 PETERSON TRIO	06 MAPLE LEAF PIANO
07 TO THE SEVENTIES	07 HOT CHOPS	07 UP TEMPO RAG
08 REPTILE CHORUS	08 UNISON LICKS	08 RIVER BOAT MOOD
Piano Pop	Jazz Waltz	Dixie Pianist
09 BALLADE POUR?	09 WALTZ FOR PIANO	09 STILL UPRIGHT?
10 CLAYDER PIANO	10 FOR EVANS SAKE	10 SPEAK EASY PIANO
11 PIANO FRANCAIS	11 BILL'S JAZZ	11 OLD JANGLER
12 MANY OCTAVES	12 BASS SOLO	12 ANOTHER NICKEL?
Rock'n' Roll		Roaring 20's
13 DOMINO PIANO		13 BOO BOOP DE BOOP
14 CRUISIN' KEYS		14 CHARLESTON TIME
15 FAT OCTAVES		15 20'S CLUB
16 BREAK DOWN		16 CHICAGO PIANO
Country	Gospel/Blues	Easy Listening
Country Piano	Gospel Ballad	Lounge Piano
01 SOUTHERN GRACE	01 CHURCH SERVICE	01 LATE AN NIGHT
02 FLOYD'S PIANO	02 INSPIRATIONI	02 QUARTER TO THREE
03 GRAMER MOOD	03 CONGREGATION	03 IN THE LOBBY
04 COUNTRY PARTNER	04 SING PRAISES	04 LAST CALL
Country Pop	Soul Ballad	Quick Fox
05 TOP OF THE PIANO	05 PIANO ON MY MIND	05 COCKTAIL PARTY
06 KAREN'S COUNTRY	06 RAY'S BALLAD	06 HIGH SOCIETY
07 WOOD CARVERS	07 GEORGIA ROADS	07 LAID BACK OCTAVE
08 SINGING ALONG	08 SOUL CHORDS	08 HOTEL COMBO
Saloon Bar	Slow Blues	Vegas Pianist
09 BAR PIANIST	09 THE STRIPPER	09 LEE IN VEGAS
10 SILENT MOVIE	10 FEELIN' BLUE	10 CABARET STAR
11 WESTERN OCTAVES	11 DOWN & DIRTY	11 ON THE STRIP
12 GET OUT OF TOWN!	12 WOKE UP THIS AM	12 CASINO LIGHTS
	Boogie Woogie	E.P. Ballad
	13 JUST BOOGIE	13 BILLY J.
	14 JIVE TIME	14 JUST THE WAY
	15 WALKIN' HANDS	15 UP TOWN E.P.
	16 DON'T FRET	16 SOLO ROMANCE
Showtime	Latin	
Broadway Stride	Salsa Piano	Piano Bossa
01 GRAND EVENING	01 SALSA SAUCE	09 MELLOW JOBIM
02 BREAK A LEG!	02 HOT OCTAVES	10 LIGHT LATIN
03 CURTAIN CALL	03 LATIN KEYS	11 BOSSA 88
04 STAR PERFORMER	04 SALSA PICANTE	12 RING ME TONIGHT
Piano Showman	Rhumba Pianist	Tango Piano
05 EY THE LEFT	05 SPANISH KEYS	13 CLOSE DANCE
06 GRAND SHOWMAN	06 LATIN COCKTAIL	14 BUENOS OCTAVES
07 PIANO BAND	07 CAVELLEROS	15 ARGENPIANO
08 PUB SING ALONG	08 CARMEN'S SUITE	16 DANCE PARTNERS

TECHNI-CHORD TYPE

<Example: C major chord>

<p>CLOSE</p>	<p>OPEN1</p>	<p>OPEN2</p>
<p>DUET</p>	<p>COUNTRY</p>	<p>THEATRE</p>
<p>HYMN</p>	<p>BLOCK</p>	<p>BIG BAND BRASS</p>
<p>BIG BAND REEDS</p>	<p>OCTAVE</p>	<p>HARD ROCK</p>
<p>FANFARE</p>		

♩ : Played note (right-hand melody)
 ○ : Added notes

REVERB

ROOM REVERB 1,2	Reverberations sound as if produced in a room (indoors) .	VOLUME REVERB TIME PRE DELAY HIGH DAMP GAIN ER. LEVEL	0 - 99 0.10 - 10.00 S 0 - 200 ms -24.0 - 0.0 dB 0 - 99
PLATE REVERB 1,2	A type of reverberation obtained from a reverb unit which utilizes the vibrations of a metal plate.	VOLUME REVERB TIME PRE DELAY HIGH DAMP GAIN ER. LEVEL	0 - 99 0.10 - 10.00 S 0 - 200 ms -24.0 - 0.0 dB 0 - 99
CONCERT REVERB 1,2	Reverberations sound as if produced in a concert hall.	VOLUME REVERB TIME PRE DELAY HIGH DAMP GAIN ER. LEVEL	0 - 99 0.40 - 30.00 S 0 - 200 ms -24.0 - 0.0 dB 0 - 99
DARK REVERB 1,2	Reverberations evoke images of darkness.	VOLUME REVERB TIME PRE DELAY HIGH DAMP GAIN ER. LEVEL	0 - 99 0.40 - 30.00 S 0 - 200 ms -24.0 - 0.0 dB 0 - 99
BRIGHT REVERB 1,2	Reverberations evoke images of brightness.	VOLUME REVERB TIME PRE DELAY HIGH DAMP GAIN ER. LEVEL	0 - 99 0.40 - 30.00 S 0 - 200 ms -24.0 - 0.0 dB 0 - 99
WAVE REVERB 1,2	Reverberations evoke images of waves.	VOLUME REVERB TIME PRE DELAY HIGH DAMP GAIN ER. LEVEL	0 - 99 0.40 - 30.00 S 0 - 200 ms -24.0 - 0.0 dB 0 - 99

VOLUME : Volume of the reverb.
REVERB TIME : The time it takes for the reverb effect to fade out.
PRE DELAY : The time elapsed between the beginning of the reverb effect.
HIGH DAMP GAIN : Adjusts the degree of damping in the treble range.
ER. LEVEL : Adjusts the early-reflection level.

DSP EFFECT

CHORUS	A natural fullness and richness is achieved by adding a sound of a slightly different pitch to the original sound.	VOLUME	0 - 99
		REV SEND	0 - 99
		DEPTH	0 - 99
		LFO SPEED	0.0 - 40.2 Hz

VOLUME : Volume of the sound to the effect is applied.
 REV SEND : The volume sent to DIGITAL REVERB.
 DEPTH : Depth of the effect.
 LFO SPEED : Transmission frequency of the LFO (low frequency oscillator) modulator.

MODULATED CHORUS	A differently modulated chorus in which the swell is emphasized.	VOLUME	0 - 99
		REV SEND	0 - 99
		DEPTH	0 - 99
		SLOW LFO SPEED	0.0 - 40.2 Hz
		FAST LFO BALANCE	0 - 99

FAST LFO BALANCE : The degree to which the fast LFO is applied.

FLANGER	An undulation is added, giving an intensity to sounds having many overtones (harmonics).	VOLUME	0 - 99
		REV SEND	0 - 99
		LFO SPEED	0.0 - 40.2 Hz
		RESONANCE	-99 - +99
		MANUAL	0 - 99

RESONANCE : Feedback volume (inverted when a minus value).

PHASER	A more distinct undulation effect than FLANGER. Ideal for electric piano type sounds.	VOLUME	0 - 99
		REV SEND	0 - 99
		LFO SPEED	0.0 - 40.2 Hz
		RESONANCE	-99 - +99
		MANUAL	0 - 99

MANUAL : Center frequency to which the effect is applied.

ENSEMBLE	Produces the effect of many musical instruments being played together.	VOLUME	0 - 99
		REV SEND	0 - 99
		DEPTH	0 - 99
		LFO SPEED	0.0 - 40.2 Hz

SINGLE DELAY	An echo effect, in which the original sound is repeated after a delay.	VOLUME	0 - 99
		REV SEND	0 - 99
		DELAY L	0 - 350 ms
		DELAY R	0 - 350 ms
		FEEDBACK L	-99 - +99
		FEEDBACK R	-99 - +99

DELAY : Time difference between original sound and the repeat (ms).
 FEEDBACK : Feedback volume (inverted when a minus level).

DISTORTION	The sound is very distorted. A powerful effect when applied to a sound which is played solo.	VOLUME	0 - 99
		REV SEND	0 - 99
		DRIVE	0 - 99
		ADJUST	0 - 99

DRIVE : Degree of distortion.
 ADJUST : The manner in which the effect is applied.

OVERDRIVE	A more natural distortion than the above effect, similar to that achieved with a vacuum tube amplifier.	VOLUME	0 - 99
		REV SEND	0 - 99
		DRIVE	0 - 99
		ADJUST	0 - 99

DSP EFFECT

EXCITER	Modulates sounds, clarifies sound profile, and projects sound forward.	VOLUME	0 - 99
		REV SEND	0 - 99
		EMPHASIS GAIN	0 - 99

EMPHASIS GAIN : The volume of the emphasis.

PARAMETRIC EQ	An equalizer which sets sound quality for a precise frequency point.	VOLUME	0 - 99
		REV SEND	0 - 99
		BAND EMPHASIS 1 Fc	50 Hz - 16kHz
		BAND EMPHASIS 1 Q	0.1 - 20.0
		BAND EMPHASIS 1 G	-12.0 - +12.0 dB
		BAND EMPHASIS 2 Fc	50 Hz - 1kHz
		BAND EMPHASIS 2 Q	0.1 - 20.0
		BAND EMPHASIS 2 G	-12.0 - +12.0 dB
		BAND EMPHASIS 3 Fc	50 Hz - 1kHz
		BAND EMPHASIS 3 Q	0.1 - 20.0
		BAND EMPHASIS 3 G	-12.0 - +12.0 dB

BAND EMPHASIS Fc : Center frequency of the modified band.
 BAND EMPHASIS Q : Sharpness of the curve of the frequency characteristic of the modified band.
 BAND EMPHASIS G : Volume of emphasis / damping in the modified band.

AUTO PAN	Periodically shifts the sound's pan position.	VOLUME	0 - 99
		REV SEND	0 - 99
		DEPTH	0 - 99
		LFO SPEED	0.0 - 40.2 Hz

VIBRATO	Modulates frequency in a vibrato pattern.	VOLUME	0 - 99
		REV SEND	0 - 99
		DEPTH	0 - 99
		LFO SPEED	0.0 - 40.2 Hz

AUTO WAH	A filter effect which automatically changes peak frequency in response to an increase in the volume of the input.	VOLUME	0 - 99
		REV SEND	0 - 99

ROTARY SPEAKER	Produces sounds that seem to be emitted from rotary speakers. Ideal for organ type sounds.	SLOW/FAST	SLOW, FAST
		VOLUME	0 - 99
		REV SEND	0 - 99
		TREBLE FAST	0.0 - 34.95 Hz
		SLOW	0.0 - 34.95 Hz
		BASS FAST	0.0 - 34.95 Hz
		SLOW	0.0 - 34.95 Hz
		DRIVE	0 - 99
VOLUME ADJUST	0 - 99		

SLOW/FAST : Switches speaker rotation speed between SLOW and FAST.

DSP EFFECT

RING MODULATOR	Produces a metallic sound. Tends to sound off key.	VOLUME	0 - 99
		REV SEND	0 - 99
		OSC SPEED	0 - 19.6 kHz

OSC SPEED : Oscillator frequency.

S (SINGLE) DELAY + CHORUS	Combines delay with chorus.	VOLUME	0 - 99
		REV SEND	0 - 99
		DELAY DRY/WET	0 - 99
		DELAY L	0 - 300 ms
		DELAY R	0 - 300 ms
		FEEDBACK L	-99 - +99
		FEEDBACK R	-99 - +99
		CHORUS DRY/WET	0 - 99
		DEPTH	0 - 99
LFO SPEED	0.0 - 40.2 Hz		

S (SINGLE) DELAY + FLANGER	Combines delay with flanger.	VOLUME	0 - 99
		REV SEND	0 - 99
		DELAY DRY/WET	0 - 99
		DELAY L	0 - 300 ms
		DELAY R	0 - 300 ms
		FEEDBACK L	-99 - +99
		FEEDBACK R	-99 - +99
		FLANGER DRY/WET	0 - 99
		LFO SPEED	0.0 - 40.2 Hz
		RESONANCE	-99 - +99
MANUAL	0 - 99		

S (SINGLE) DELAY + PHASER	Combines delay with phaser.	VOLUME	0 - 99
		REV SEND	0 - 99
		DELAY DRY/WET	0 - 99
		DELAY L	0 - 300 ms
		DELAY R	0 - 300 ms
		FEEDBACK L	-99 - +99
		FEEDBACK R	-99 - +99
		PHASER DRY/WET	0 - 99
		LFO SPEED	0.0 - 40.2 Hz
		RESONANCE	-99 - +99
MANUAL	0 - 99		

AUTO WAH + S (SINGLE) DELAY	Combines auto wah with delay.	VOLUME	0 - 99
		REV SEND	0 - 99
		DELAY DRY/WET	0 - 99
		DELAY L	0 - 300 ms
		DELAY R	0 - 300 ms
		FEEDBACK L	-99 - +99
		FEEDBACK R	-99 - +99

DSP EFFECT

DIST + DELAY	Combines distortion with delay.	VOLUME	0	-	99
		REV SEND	0	-	99
		DRIVE	0	-	99
		ADJUST	0	-	99
		DELAY DRY/WET	0	-	99
		DELAY L	0	-	300 ms
		DELAY R	0	-	300 ms
		FEEDBACK L	-99	-	+ 99
		FEEDBACK R	-99	-	+ 99

OVERDR + DELAY	Combines overdrive with delay.	VOLUME	0	-	99
		REV SEND	0	-	99
		DRIVE	0	-	99
		ADJUST	0	-	99
		DELAY DRY/WET	0	-	99
		DELAY L	0	-	300 ms
		DELAY R	0	-	300 ms
		FEEDBACK L	-99	-	+ 99
		FEEDBACK R	-99	-	+ 99

MIDI Implementation Chart

Digital Ensemble [SX-PR700/SX-PR900]

(Transmitted)

Function	RIGHT1,2,LEFT, PART4~15	PART16	ACMP1	ACMP2,3	BASS	DRUMS	CHORD	CONTROL	Remarks
Basic Default	1-16	1-16	1-16	1-16	1-16	1-16	1-16	1-16	memorized
Channel Changed	1-16	1-16	1-16	1-16	1-16	1-16	1-16	1-16	
Mode Default	3	3	3	3	3	3	3	3	OMNI OFF, POLY MODE
Mode Messages	×	×	×	×	×	×	×	×	
Mode Altered	-	-	-	-	-	-	-	-	
Note Number True voice	0-119	0-119	0-119	0-119	0-119	0-119	0-119	-	Changes depending on the position of the transpose control, octave shift, and drums type.
Velocity Note ON	○	○	○	○	○	○	○	-	
Velocity Note OFF	×	×	×	×	×	×	×	-	
After Key's	×	×	×	×	×	×	×	-	Transmitted during SEQUENCER playback.
Touch Ch's	○×*	×	×	×	×	×	×	-	
Pitch Bend	○×*	×	○×*	○×*	○×*	×	○×*	×	Transmitted during SEQUENCER playback and during rhythm performance.
Control Change	0,32	○×*	○×*	○×*	○×*	○×*	○×*	×	bank select MSB, LSB
	1	○×*	×	○×*	○×*	○×*	×	×	modulation
	6,38	○×*	×	×	×	×	×	×	data entry MSB, LSB
	7	○×*	○×*	○×*	○×*	○×*	○×*	×	volume
	10	○×*	×	○×*	○×*	○×*	×	×	panpot
	11	○×*	○×*	○×*	○×*	○×*	×	×	expression
	64	○×*	×	○×*	○×*	○×*	×	×	sustain
	66	○	×	×	×	×	×	×	sostenute
	67	○	×	×	×	×	×	×	soft
	80	×	×	○×*	×	×	×	×	auto play chord
	82	×	×	×	×	×	○×*	×	intro, fill in, ending
	91	○×*	○×*	○×*	○×*	○×*	○×*	○×*	reverb
93	○×*	○×*	×	×	×	×	×	DSP effect	
94	○×*	×	○×*	○×*	○×*	×	○×*	digital effect	
100,101	○×*	×	×	×	×	×	×	RPN LSB, MSB	
120	○	○	×	×	×	×	×	all sound off	
121	○×*	○×*	×	×	×	×	×	reset all controllers	
Prog Change True #	○×*	○×*	○×*	○×*	○×*	○×*	○×*	×	Changes depending on program change mode and prog.cng to p.mem.
System exclusive	○								
System common Song Pos	○×*								
System common Song Sel	○×* (0-19)								
System common Tune	×								
System Clock	○								
Real Time Commands	○×*								start/stop, continue
Aux Local ON/OFF	×	×	×	×	×	×	×	-	
Aux All notes OFF	×	×	×	×	×	×	×	-	
Messages Active Sense	○								
Messages Reset	×								
Notes	○×*.....Whether or not the data for each of these items is transmitted can be set.								

Mode 1: OMNI ON, POLY

Mode 2: OMNI ON, MONO

○:Yes

Mode 3: OMNI OFF, POLY

Mode 4: OMNI OFF, MONO

×:No

MIDI Implementation Chart

Digital Ensemble [SX-PR700/SX-PR900]

(Recognized)

Function	RIGHT1,2,LEFT, PART4~15	PART16	ACMP1	ACMP2,3	BASS	DRUMS	CHORD	CONTROL	Remarks	
Basic Default	1-16	1-16	1-16	1-16	1-16	1-16	1-16	1-16	memorized	
Channel Changed	1-16	1-16	1-16	1-16	1-16	1-16	1-16	1-16		
Mode Default	3	3	3	3	3	3	3	3	OMNI OFF, POLY MODE	
Mode Messages	×	×	×	×	×	×	×	×		
Mode Altered	-	-	-	-	-	-	-	-		
Note Number True voice	0-127	0-127	0-127	0-127	0-127	0-127	0-127	0-127	Changes depending on the position of the transpose control, octave shift, and drums type.	
Velocity Note ON	○	○	○	○	○	○	○	○		
Velocity Note OFF	×	×	×	×	×	×	×	×		
After Key's	×	×	×	×	×	×	×	×		
Touch Ch's	○×*	×	×	×	×	×	×	×		
Pitch Bend	○×*	×	○×*	○×*	○×*	×	○×*	×		
Control Change	0,32 1 6,38 7 10 11 64 66 67 80 82 91 93 94 100,101 120 121	○×* ○×* ○×* ○×* ○×* ○×* ○×* ○ ○ ×	○×* ×	○×* ○×* ○×* ○×* ○×* ○×* ○×* ×	○×* ○×* ○×* ○×* ○×* ○×* ○×* ×	○×* ○×* ○×* ○×* ○×* ○×* ○×* ×	○×* ○×* ○×* ○×* ○×* ○×* ○×* ○×* ○×* ○×* ○×* ○×* ○×* ○×* ○×* ○×* ○×* ○×*	○×* ○×* ○×* ○×* ○×* ○×* ○×* ○×* ○×* ○×* ○×* ○×* ○×* ○×* ○×* ○×* ○×* ○×* ○×*	×	bank select MSB, LSB modulation data entry MSB, LSB volume panpot expression sustain sostenute soft auto play chord intro, fill in, ending reverb DSP effect digital effect RPN LSB, MSB all sound off reset all controllers
Prog Change True #	○×*	○×*	○×*	○×*	○×*	○×*	○×*	○×*	Changes depending on program change mode and prog.cng to p.mem.	
System exclusive				○						
System common	Song Pos			○×*						
System common	Song Sel			○×* (0-19)						
System common	Tune			×						
System common	Clock			○						
Real Time	Commands			○×*					start/stop.continue	
Aux	Local ON/OFF	×	×	×	×	×	×	×		
Aux	All notes OFF	○	○	○	○	○	○	○		
Messages	Active Sense			○						
Messages	Reset			×						
Notes	○×*.....Whether or not the data for each of these items is received can be set.									

Mode 1: OMNI ON, POLY

Mode 2: OMNI ON, MONO

○:Yes

Mode 3: OMNI OFF, POLY

Mode 4: OMNI OFF, MONO

×:No

MIDI DATA FORMAT

MIDI DATA FLOWCHART

<MIDI INPUT>

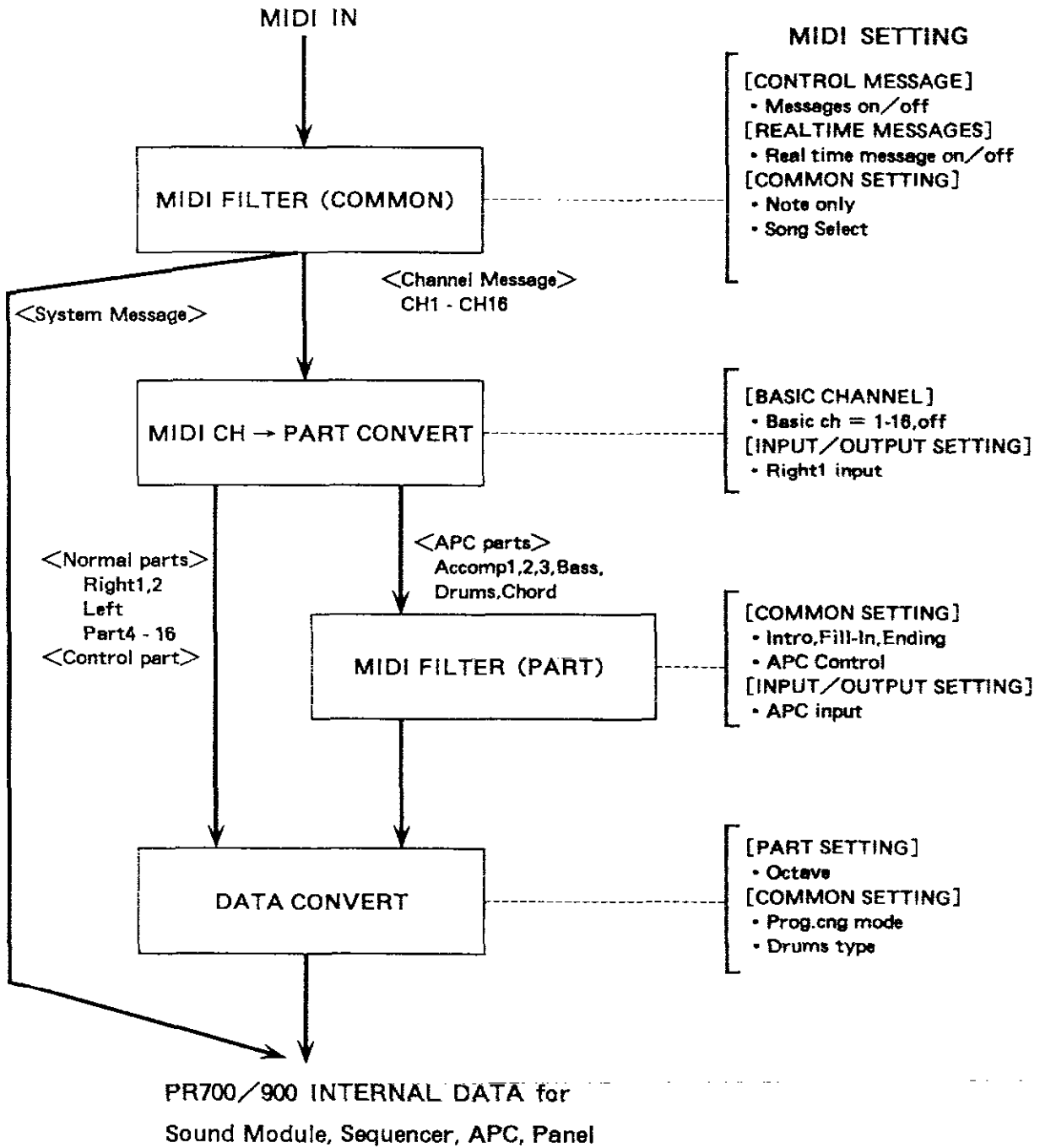

<MIDI OUTPUT>

PR700/900 INTERNAL DATA from
Keyboard, Sequencer, APC, Panel

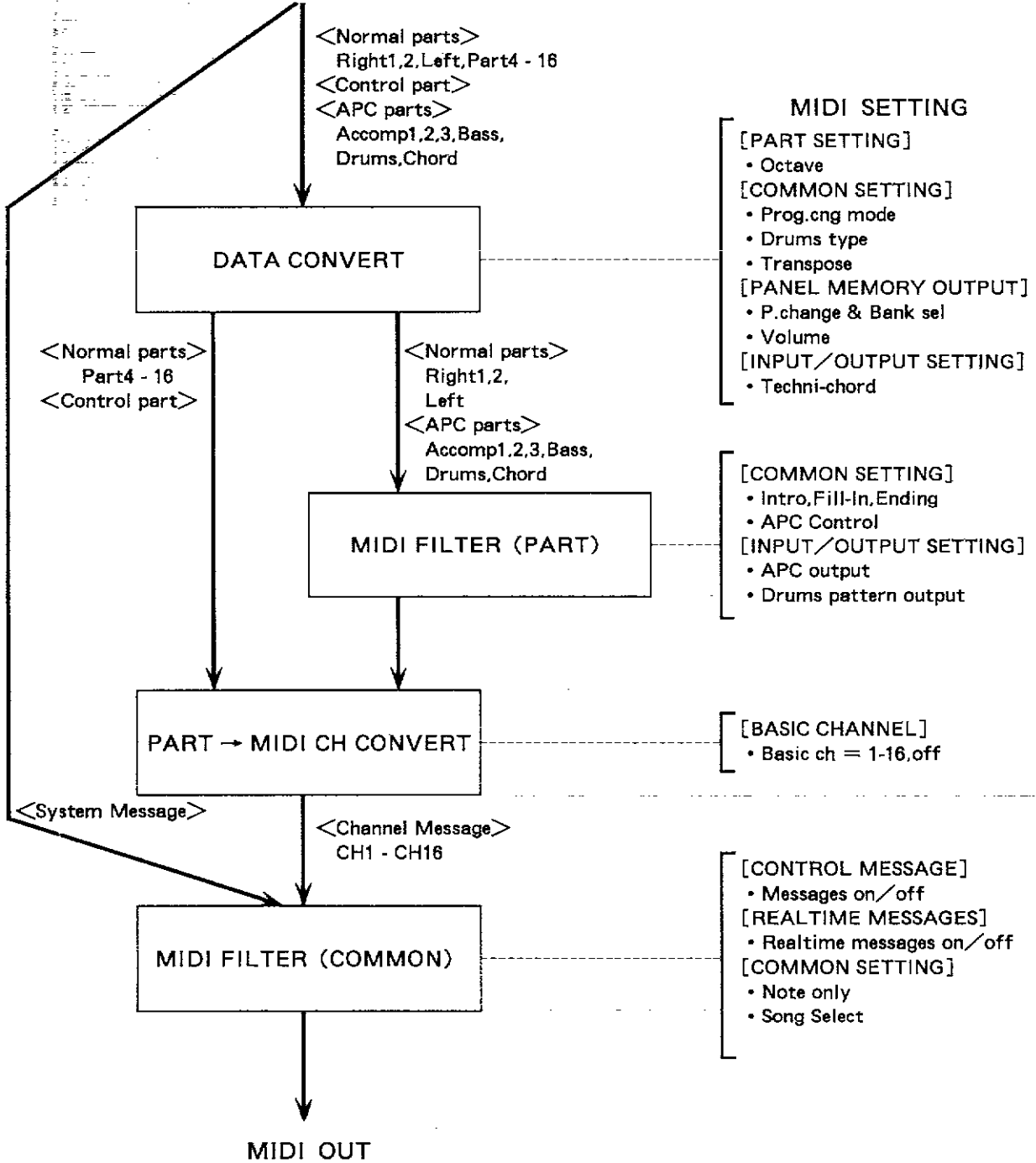

Message format

■ Channel voice message

Note off

8nH	Note off status
kk	Note number
vv	Velocity

n: 0-F Basic channel

kk: 00H-7FH Note number

vv: 00H-7FH Velocity

•This status is not used during transmission; rather, velocity=0 is transmitted with the note on status.

Note on

9nH	Note on status
kk	Note number
vv	Velocity

n: 0-F Basic channel

kk: 00H-7FH Note number

vv: 01H-7FH Velocity

00H Note off

Control change

Bank select

BnH	Control change status
00H	Bank select (MSB)
mm	Bank select value (MSB)
(BnH)	Control change status
20H	Bank select (LSB)
ll	Bank select value (LSB)

n: 0-F Basic channel

mm,ll: 00H-7FH

•Indicates program change bank. Used when program change mode is set to Normal mode or Technics mode.

•Reception of ACCOMP 1,2,3,BASS,and DRUMS bank select is possible only during COMPOSER record.

Modulation

BnH	Control change status
01H	Modulation
vv	Modulation depth value

n: 0-F Basic channel

vv: 00H-7FH

•Reception of ACCOMP 1,2,3 and BASS modulation is possible only during COMPOSER record.

Data entry

BnH	Control change status
06H	Data entry (MSB)
mm	Data entry value (MSB)
(BnH)	Control change status
26H	Data entry (LSB)
ll	Data entry value (LSB)

n: 0-F Basic channel

mm,ll: Values conform to the parameters specified for the RPN.

Volume

BnH	Control change status
07H	Part volume
vv	Part volume value

n: 0-F Basic channel

vv: 00H-7FH

Panpot

BnH	Control change status
0AH	Panpot
vv	Panpot value

n: 0-F Basic channel

vv: 00H-7FH

•Reception of ACCOMP 1,2,3 and BASS panpot is possible only during COMPOSER record.

Expression

BnH	Control change status
0BH	Expression
vv	Expression value

n: 0-F Basic channel

vv: 00H-7FH

Sustain

BnH	Control change status
40H	Sustain
vv	Sustain on/off

n: 0-F Basic channel

vv: 00H-3FH (00H) Off

40H-7FH (7FH) On

•Transmitted data is indicated by parentheses().

•Reception of ACCOMP 1,2,3 and BASS sustain is possible only during COMPOSER record.

Sostenute pedal

BnH	Control change status
42H	Sostenuto
vv	Sostenuto on/off

n: 0-F Basic channel
 vv: 00H-3FH (00H) Off
 40H-7FH (7FH) On

•Transmitted data is indicated by parentheses () .

Soft pedal

BnH	Control change status
43H	Soft
vv	Soft on/off

n: 0-F Basic channel
 vv: 00H-3FH (00H) Off
 40H-7FH (7FH) On

•Transmitted data is indicated by parentheses () .

Auto Play Chord

BnH	Control change status
50H	APC message
vv	APC message value

n: 0-F Basic channel
 vv: 00H = Off
 01H = ADVANCED1
 02H = BASIC
 03H = PIANIST
 04H = ADVANCED2

•Transmitted / received on the basic channel for the ACCOMP 1 part.

Rhythm control

BnH	Control change status
52H	Rhythm control message
vv	Rhythm control data

n: 0-F Basic channel
 vv: 00H = off
 01H = FILL IN 1
 02H = ENDING 1
 03H = INTRO 1
 05H = FILL IN 2
 06H = ENDING 2
 07H = COUNT INTRO
 08H = INTRO 2

•Transmitted / received on the basic channel for the DRUMS part.

Reverb

BnH	Control change status
5BH	Reverb
vv	Reverb on/off

n: 0-F Basic channel
 vv (CONTROL part): 00H-3FH (00H) Off
 40H-7FH (7FH) On
 vv (Other parts): 00H-7FH

•Transmitted data is indicated by parentheses () .
 •The Reverb for the CONTROL part is the total reverb.

Digital effect

BnH	Control change status
5EH	Digital effect
vv	Digital effect on/off

n: 0-F Basic channel
 vv: 00H-3FH (00H) Off
 40H-7FH (7FH) On

•Transmitted data is indicated by parentheses () .
 •Transmission/reception of the DIGITAL EFFECT for ACCOMP 1,2,3 and BASS is possible only during COMPOSER record.

DSP effect

BnH	Control change status
5DH	DSP effect
vv	DSP effect on/off

n: 0-F Basic channel
 vv: 00H-7FH

•Transmitted data is indicated by parentheses () .

RPN

BnH	Control change status
65H	RPN (MSB)
mm	RPN data number (MSB)
(BnH)	Control change status
64H	RPN (LSB)
ll	RPN data number (LSB)

n: 0-F Basic channel
 mm,ll : The most significant byte (MSB) and least significant byte (LSB) of the parameter number specified for the RPN.

The RPN which can be transmitted / received are Pitch Bend Sensitivity, Fine Tuning, Coarse Tuning (corresponding respectively to the Pitch bend Range, Tuning and Key Shift of the PR700/900), and RPN reset.

RPN

RPN		Data Entry		
MSB	LSB	MSB	LSB	
00H	00H	mm	---	Pitch Bend Sensitivity mm:00H - 0CH (0 - 12semi-tones) ll:ignored •Up to 1 octave can be specified in semi-tone increments.
00H	01H	mm	ll	Fine Tuning mm,ll:00H,00H - 40H,00H - 7FH,7FH (-128 * 100 / 128 - 0 - 127 * 100 / 128 cents) •ll:00H or 40H (lower 6 bits ignored) •Can be specified in 100 / 128 cent increments.
00H	02H	mm	---	Coarse Tuning mm,34H - 40H - 4CH (-12 - 0 - +12semi-tones) ll:ignored •Up to 1 octave can be specified in semi-tone increments.
7FH	7FH	---	---	RPN Reset mm,ll:ignored •For when the RPN number is not specified. •The internal set value does not change.

Program change

CnH	Program change status
pp	Program change value

- n: 0-F Basic channel
 pp: 00H-7FH Program change value
 Normal mode: Numbers are correspond to the SW of the SOUND GROUP(the variation is indicated by the Bank Select).
 Technics mode: Numbers are standardized among Technics modes(Bank Select also used).
 GM:GM program change numbers.
 •The Program Change for the Drums part is recognized as a change in the rhythm pattern select.
 •Reception of ACCOMP 1,2,3,BASS and DRUMS program change is possible only during COMP-OSER record.

Channel pressure (After Touch)

DnH	Channel pressure status
VV	Channel pressure value

- n: 0-F Basic channel
 vv: 00H-7FH

Pitch bend change

EnH	Pitch bend status
ll	Pitch bend value (LSB)
mm	Pitch bend value (MSB)

- n: 0-F Basic channel
 ll,mm: 00H-7FH Pitch bend data
 •The Pitch Bend Range is determined by the Pitch Bend Range(Pitch Bend Sensitivity)of each part.
 •Reception of accomp 1,2,3 and BASS pitch bend change is possible only during COMPOSER record.

Channel mode message

All sound off

BnH	Channel mode status
78H	All sound off
00H	Dummy data

- n: 0-F Basic channel

Reset all controllers

BnH	Channel mode status
79H	Reset all controllers
00H	Dummy data

- n: 0-F Basic channel

All note off

BnH	Channel mode status
7BH	All note off
00H	Dummy data

- n: 0-F Basic channel
 Receive only

OMNI off

BnH	Channel mode status
7CH	OMNI off
00H	Dummy data

- n: 0-F Basic channel
 •Processed in same manner as when ALL Note off is received.

OMNI on

BnH	Channel mode status
7DH	OMNI on
00H	Dummy data

- n: 0-F Basic channel
 •Processed in same manner as when ALL Note off is received. Does not change to OMNI on.

MONO

BnH	Channel mode status
7EH	MONO
00H	Dummy data

n: 0-F Basic channel

•Processed in same manner as when ALL Note off is received. Does not change to MONO.

POLY

BnH	Channel mode status
7FH	POLY
00H	Dummy data

n: 0-F Basic channel

•Processed in same manner as when ALL Note off is received.

■ System common message

Song position pointer

F2H	Song position pointer
ll	Least significant
mm	Most significant

ll,mm: 00H-7FH

Song select

F3H	Song select
ss	Song number

ss: 0-19

■ System real time message

Timing Clock

F8H	Timing clock
-----	--------------

Start

FAH	Start
-----	-------

Continue

FBH	Continue
-----	----------

Stop

FCH	Stop
-----	------

Active Sense

FEH	Active sense
-----	--------------

System exclusive

F0H	System exclusive status
ii	ID number
dd	data
:	:
dd	data
F7H	End of exclusive status

ii: 7EH(universal non-real time ID),
50H(Technics ID)

dd: 00H-7FH

About the PR700 / PR900 MIDI exclusive

Outline of PR700 / PR900 MIDI exclusive

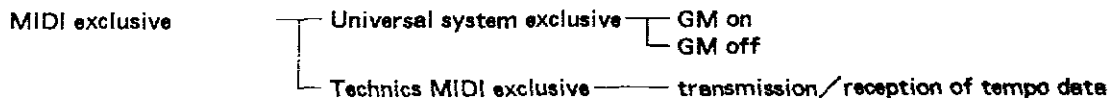

Universal system exclusive Message format

Turn General MIDI System On:

F0H	Exclusive status
7EH	Universal Non-Real Time SysEx
7FH	ID of target device (7F:Broadcast)
09H	sub-ID # 1 = General MIDI message
01H	sub-ID # 2 = General MIDI on
F7H	EOX

Turn General MIDI System Off:

F0H	Exclusive status
7EH	Universal Non-Real Time SysEx
7FH	ID of target device (7F:Broadcast)
09H	sub-ID # 1 = General MIDI message
02H	sub-ID # 2 = General MIDI off
F7H	EOX

Technics MIDI exclusive Message format

Tempo data:

F0H	Exclusive status
50H	Technics ID number
25H	Command ID (TMP=Tempo data ID)
DT1	Tempo data LSB
DT2	Tempo data MSB
F7H	End of exclusive

• [data] for Tempo.

DT1	Data LSB
DT2	Data MSB

DT2, DT1 : 02H, 08H-12H, 0Ch
(J = 40-300)

Tempo data is 9bit Binary (=101000~100101100)
The lower 4 bits is expressed as DT1, and the remaining upper 5 bits as DT2. DT1 is sent first followed by DT2.

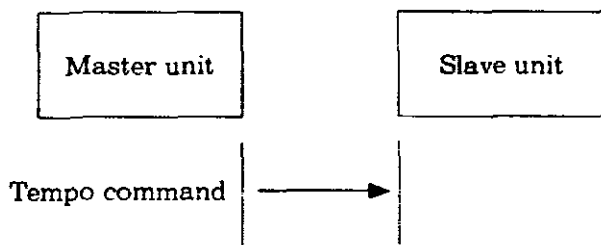

•Transmission/reception of TEMPO exclusive data can be enabled or disabled by the NOTE ONLY setting of the MIDI settings.

GENERAL MIDI SETTINGS

■ SOUND

P.CNG#	SOUND NAME	P.CNG#	SOUND NAME	P.CNG#	SOUND NAME	P.CNG#	SOUND NAME
1	Piano	33	Acoustic Bass	65	Soprano Sax	97	Ice Rain
2	Rock Piano	34	Bright E.Bass	66	Alto Sax	98	Soundtrack
3	Electric Grand	35	Picked E.Bass	67	Tenor Sax	99	Synth Glocken
4	Honky-Tonk Piano	36	Fretless Bass	68	Baritone Sax	100	Atmosphere
5	E.Piano 1	37	Slap Bass 1	69	Oboe	101	Mist
6	Modern E.P.1	38	Slap Bass 2	70	English Horn	102	Goblins
7	Harpsichord	39	Wow Bass 1	71	Bassoon	103	Echo Drops
8	Clavi	40	Synth Chopper	72	Jazz Clarinet 1	104	Star Theme
9	Celesta	41	Violin	73	Piccolo	105	Sitar
10	Glockenspiel	42	Viola	74	Jazz Flute	106	Banjo
11	Music Box	43	Cello	75	Recorder	107	Shamisen
12	Vibraphone	44	Bowed Bass	76	Pan Flute 1	108	Koto
13	Marimba	45	Tremolo Strings	77	Blown Bottle	109	Kalimba
14	Xylophone	46	Pizzicato Str.	78	Shakuhachi	110	Bagpipe
15	Tubular Bells	47	Harp	79	Whistle	111	Fiddle
16	Dulcimer	48	Timpani	80	Ocarina	112	Shanai
17	Full Drawbars	49	Classical Strings	81	Square Lead	113	Tinkle Bell
18	Jazz Organ	50	Slow Strings	82	Saw Lead	114	Agogo
19	Rock Organ	51	Synth Strings 1	83	Synth Calliope	115	Steel Drum
20	Pipe Organ 1	52	Synth Strings 2	84	Chiffer Lead	116	Wood Block
21	Harmonium	53	Vocal Ah	85	Charang	117	Taiko Drum
22	Bright Accordion	54	Vocal Doo	86	Air Vox	118	Melodic Tom
23	Blues Harmonica	55	Synth Vocal	87	5th Wave	119	Synth Drum
24	Bandoneon	56	Orchestra Hit 1	88	Bass & Lead	120	Reverse Cymbal
25	Jazz Ac.Guitar	57	Trumpet 1	89	Fantasia	121	Fret Noise
26	Folk Guitar	58	Bright Trombone	90	Mellow Ensemble	122	Breath Noise
27	Jazz Guitar 1	59	Orchestral Tuba	91	Polysynth	123	Seashore
28	Bright Solid Gtr	60	Harmon Mute Tpt	92	Spacy Pad	124	Bird Tweet
29	Mute Guitar	61	Open Fr.Horn	93	Bowed Glass	125	Telephone
30	Overdrive Guitar	62	Brass	94	Metal Pad	126	Helicopter
31	Distortion Gtr	63	Synth Brass 1	95	Halo Pad	127	Applause
32	Rock Harmonics	64	Mellow Synth Brass	96	Sweep Pad	128	Gun Shot

■ Parts

MIDI CHANNEL	1	2	3	4	5	6	7	8	9	10	11	12	13	14	15	16
PART	R1	R2	L	P4	P5	P6	P7	P8	P9	P16	P11	P12	P13	P14	P15	P10
SEQUENCER TRACK	1	2	3	4	5	6	7	8	9	10	11	12	13	14	15	16

■ Non-working Function

DEMO,RHYTHM GROUP,ONE TOUCH PLAY/MUSIC STYLE SELECT, PIANO STYLIST,
MUSIC STYLE ARRANGER, PANEL MEMORY, TECHNI-CHORD, AUTO PLAY CHORD, COMPOSER,
SOUND ARRANGER etc.

HOW TO USE MIDI PRESETS

The PR piano can be connected to any MIDI equipped musical Instrument.

To connect the PR piano to another instrument use a standard MIDI cable and connect the MIDI OUT socket of the MASTER UNIT (the one you are playing) to the MIDI IN socket of the SLAVE UNIT.

MIDI Presets are designed to help you set up the PR piano quickly and easily for use with various other instruments.

There are two pages of MIDI Presets, the first with the PR piano as the master unit and the second with the PR piano as the slave. On the appropriate page highlight the other product type that you are using and select whether or not you want to use Auto Play Chord, and press OK.

Many applications are very simple, but the following guidelines should be helpful with more complicated setups.

■ MIDI PRESETS FOR CONNECTING THE PR PIANO TO AN ORGAN USING AUTO PLAY CHORD.

SLAVE UNIT		MIDI PRESET	
EQUIPMENT		TYPE	APC
ORGAN (FA/GA/EA)		SLAVE : ORGAN TYPE2	WITH APC
ORGAN (OTHERS)		SLAVE : ORGAN TYPE1	WITH APC

■ MIDI PRESETS FOR CONNECTING THE PR PIANO TO AN ORGAN WITHOUT AUTO PLAY CHORD.

SLAVE UNIT		MIDI PRESET	
EQUIPMENT		TYPE	APC
ORGAN (FA/GA/EA)		SLAVE : ORGAN TYPE2	WITHOUT APC
ORGAN (OTHERS)		SLAVE : ORGAN TYPE1	WITHOUT APC

■ MIDI PRESETS FOR CONNECTING THE PR PIANO TO AN EXT. SEQUENCER USING AUTO PLAY CHORD.

SLAVE UNIT		MIDI PRESET	
EQUIPMENT	APC output	TYPE	APC
EXT. SEQ	ACCOMPANIMENT PATTERN	SLAVE : EXT. SEQ CASE1	WITH APC
EXT. SEQ	CHORD	SLAVE : EXT. SEQ CASE2	WITH APC

[NOTES]

1. About "KEYBOARD/ORGAN TYPE1" and "KEYBOARD/ORGAN TYPE2".

TYPE1 : Equipment which does not have MIDI presets.

TYPE2 : Equipment which has MIDI presets. (= KN3000, KN2000, KN1200, KN700, KN901, etc.)

2. If you use a MIDI preset to connect any other instrument to the PR piano using Auto Play Chord , the PR piano will be set to MIDI clock. This means that the PR's Rhythm will start & stop from the start/stop button of the master unit and the tempo will be controlled by the master unit. It is preferable to set the Rhythm and Accompaniment balances of the master unit to zero to avoid any unpleasant clashes with the PR's Rhythm & Accompaniment.

MIDI PRESETS DATA

Master ↓ Slave		Without APC										With APC									
		PR series								Kbd type2	Ext SEQ	PR series								Kbd type2	Ext SEQ
		Keyboard		Organ		Sound Module	Vocal- ist	Ext SEQ	PR series			Keyboard		Organ		Sound Module	Vocal- ist	Ext SEQ	PR series		
type1	type2	type1	type2	type1	type2					type1	type2	type1	type2	type1	type2					case1	case2
Basic	Right1	1	1	1	1	1	1	1	1	1	1	1	1	1	1	1	off	1	1	1	1
channel	Right2	2	2	3	3	2	2	2	2	2	2	2	2	3	3	2	2	2	2	2	2
	Left	4	3	2	2	3	3	3	3	3	3	4	3	2	2	3	3	3	3	3	3
	Part4	3	4	4	4	4	4	4	4	4	4	3	4	4	4	4	4	4	4	4	4
	Part5	5	5	5	5	5	5	5	5	5	5	off	off	off	off	5	5	off	5	off	off
	Part6	6	6	6	6	6	6	6	6	6	6	6	6	6	6	6	6	6	6	6	6
	Part7	7	7	7	7	7	7	7	7	7	7	7	7	7	7	7	7	7	7	7	7
	Part8	8	8	8	8	8	8	8	8	8	8	8	8	8	8	8	8	8	8	8	8
	Part9	9	9	9	9	9	9	9	9	9	9	9	9	9	9	9	9	9	9	9	9
	Part10	10	10	10	10	16	10	10	10	10	10	10	10	10	10	off	10	10	10	10	10
	Part11	11	11	11	11	11	11	11	11	11	11	11	11	11	11	11	11	11	11	11	11
	Part12	12	12	12	12	12	12	12	12	12	12	12	12	12	12	12	12	12	off	12	12
	Part13	13	13	13	13	13	13	13	13	13	13	13	13	13	13	off	13	13	off	13	13
	Part14	14	14	14	14	14	14	14	14	14	14	14	14	14	14	off	14	14	off	14	14
	Part15	16	15	16	15	15	15	15	15	off	15	off	15	off	15	off	15	15	off	15	15
	Part16	15	16	15	16	10	16	16	16	16	off	16	off	off	16	off	off	off	off	off	off
	Control	off	off	off	off	off	off	off	off	off	off	off	off	off	off	off	off	off	off	off	off
	Accomp1	off	off	off	off	off	off	off	off	off	off	off	off	off	off	13	off	off	12	off	off
	Accomp2	off	off	off	off	off	off	off	off	off	off	off	off	off	off	14	off	off	13	off	off
	Accomp3	off	off	off	off	off	off	off	off	off	off	off	off	off	off	15	off	off	14	off	off
	Bass	off	off	off	off	off	off	off	off	off	off	off	off	off	off	16	off	off	15	off	off
	Drums	off	off	off	off	off	off	off	off	15	16	15	16	10	off	16	16	16	16	16	
	Cherd	off	off	off	off	off	off	off	off	5	5	5	5	off	1	5	off	5	5	5	
Octave all ch.		0	0	0	0	0	0	0	0	0	0	0	0	0	0	0	0	0	0	0	0
Local all ch.		on	on	on	on	on	on	off	on	on	on	on	on	on	on	on	on	on	on	on	
Prog. change		on	on	on	on	on	on	on	on	on	on	on	on	on	on	on	on	on	on	on	
Bank select		on	on	on	on	on	on	on	on	on	on	on	on	on	on	on	on	on	on	on	
Pitch bend		on	on	on	on	on	on	on	on	on	on	on	on	on	on	on	on	on	on	on	
Volume		on	on	on	on	on	on	on	on	on	on	on	on	on	on	on	on	on	on	on	
Expression		on	on	on	on	on	on	on	on	on	on	on	on	on	on	on	on	on	on	on	
Panpot		on	on	on	on	on	on	on	on	on	on	on	on	on	on	on	on	on	on	on	
Sustain		on	on	on	on	on	on	on	on	on	on	on	on	on	on	on	on	on	on	on	
Eff&Rev		on	on	on	on	on	on	on	on	on	on	on	on	on	on	on	on	on	on	on	
Modulation		on	on	on	on	on	on	on	on	on	on	on	on	on	on	on	on	on	on	on	
Tuning		on	on	on	on	on	on	on	on	on	on	on	on	on	on	on	on	on	on	on	
Bend range		on	on	on	on	on	on	on	on	on	on	on	on	on	on	on	on	on	on	on	
After touch		on	on	on	on	on	on	on	on	on	on	on	on	on	on	on	on	on	on	on	
Reset all cnt.		on	on	on	on	on	on	on	on	on	on	on	on	on	on	on	on	on	on	on	
Realtime msg		on	on	on	on	on	on	on	on	off	off	on	on	on	on	on	on	on	on	on	off
Clock		int	int	int	int	int	int	int	int	MIDI	MIDI	int	int	int	int	int	int	int	int	int	MIDI
Right1 input		dir	dir	dir	dir	dir	dir	dir	dir	dir	dir	dir	dir	dir	dir	dir	dir	dir	dir	dir	dir
APC in		off	off	off	off	off	off	off	off	off	off	on	on	on	on	off	off	on	on	on	on
Technichord out		on	on	on	on	on	on	on	off	off	off	on	on	on	on	on	on	on	on	off	off
Drums out		off	off	off	off	off	off	off	off	off	off	off	off	off	off	on	off	off	on	off	off
APC out		off	off	off	off	off	off	off	off	off	off	on	on	on	on	on	on	on	on	on	on
P. cng to P. mem		off	off	off	off	off	off	off	off	off	off	off	off	off	off	off	off	off	off	off	off
Note only		off	off	off	off	off	off	off	off	off	off	off	off	off	off	off	off	off	off	off	off
Intro/Fill		on	on	on	on	on	on	on	on	on	on	on	on	on	on	on	on	on	on	on	on
APC control		off	off	off	off	off	off	off	off	off	off	on	on	on	on	off	off	on	off	on	on
Transpose		off	off	off	off	off	off	off	off	off	off	off	off	off	off	off	off	off	off	off	off
Prog. cng mode		TECH	TECH	TECH	TECH	GM	NORM	TECH	TECH	TECH	TECH	TECH	TECH	TECH	TECH	GM	NORM	TECH	TECH	TECH	TECH
Drums type		TECH	TECH	TECH	TECH	GM	NORM	TECH	TECH	TECH	TECH	TECH	TECH	TECH	TECH	GM	NORM	TECH	TECH	TECH	TECH
Song select		on	on	on	on	off	off	off	on	on	on	on	on	on	on	off	off	on	on	on	on

527.

sx-PR700/sx-PR900

Technics

Playback of Technics disks

- The PR700/PR900 can play back disk data from the following instrument models:

PR250/PR350	PR270/PR370	PR207/PR307	PR Series	KN3000
-------------	-------------	-------------	-----------	--------

- The following data is compatible:

COMPOSER data
SEQUENCER data
Registration data (panel and PANEL MEMORY data)

- Functions of other models which are not incorporated in the **PR700/PR900** are not compatible. Moreover, if such functions are included in the **COMPOSER**, **SEQUENCER** or registration data on the disk, they will not be reproduced correctly.
- For some sounds, the playback octave may be different from the recorded octave.
- The parameters of **DIGITAL REVERB** and **DSP EFFECT** are different from those of other models, therefore only the effect type will be matched.

- **Compatibility with KN3000 disk data: notable items**

<p>These functions are not available on the PR700/PR900 and will not be reproduced correctly.</p>	<p>MEMORY SOUND, USER DRUMS as well as data which uses these functions</p> <ul style="list-style-type: none"> • MEMORY SOUND is reproduced as the Grand Piano sound, USER DRUMS as the Standard KIT.
<p>The configuration of this feature on the PR700/PR900 is different from the KN3000 so it will not be reproduced correctly.</p>	<p>MANUAL SEQUENCE PADS, SOUND ARRANGER as well as data which uses these functions</p>
<p>Due to the smaller number of banks and memory size of the PR700/PR900, the following data cannot be loaded.</p>	<p>MUSIC STYLE ARRANGER</p> <p>KN3000: B-3 to C-8 of the PANEL MEMORY SEQUENCER data which exceeds the capacity of the PR700/PR900 SEQUENCER (30,000 notes)</p>

- **Compatibility with PR250/PR350, PR270/PR370, PR207/PR307 and PR Series disk data: notable items**

<p>These functions not available in the PR700/PR900 will not be reproduced correctly.</p>	<p>Recorded dual balance settings of each sound</p>
--	---

- The RKB and LKB playback parts are provided on the **PR700/PR900** for compatibility with the **RIGHT** and **LEFT SEQUENCER** tracks of previous models. However, these parts cannot be recorded or edited.

sx-PR700/sx-PR900

Technics

Reproduction des disquettes de format Technics

- Le PR700/PR900 peut reproduire les données sur les disquettes provenant des modèles suivants:

PR250/PR350	PR270/PR370	PR207/PR307	Séries PR	KN3000
-------------	-------------	-------------	-----------	--------

- Les données suivantes sont compatibles

Données de COMPOSER
Données de SEQUENCER
Données de la registration (panneau et données de PANEL MEMORY)

- Des fonctions qui ne sont pas incorporées dans le **PR700/PR900** ne sont pas compatibles. Par conséquence, si telles fonctions sont incluses dans les données de **COMPOSER**, de **SEQUENCER** ou de la registration sur la disquette, elles ne sont pas reproduites correctement.
- Pour certaines sonorités, l'octave reproduite peut être différente à celle enregistrée.
- Les caractéristiques techniques du **DIGITAL REVERB** et **DSP EFFECT** de ces autres modèles sont différentes, seul le type de l'effet est interchangeable, par conséquence.

- Compatibilité avec les données de **KN3000**: points notables

Fonctions qui ne seront pas reproduites correctement par manque de fonctions dans le PR700/PR900	MEMORY SOUND , USER DRUMS ainsi que des données qui utilisent ces fonctions <ul style="list-style-type: none">• MEMORY SOUND est reproduit par la sonorité de Grand Piano, USER DRUMS est par les sonorités de Standard KIT.
	MANUAL SEQUENCE PADS , SOUND ARRANGER ainsi que des données qui utilisent ces fonctions
Fonction qui n'est pas reproduite correctement à la conséquence de la différence des caractéristiques techniques du PR700/PR900	MUSIC STYLE ARRANGER
Données qui ne peuvent pas chargées par manque du numéro de banques et l'espace mémoire du PR700/PR900	KN3000: B-3 à C-8 de PANEL MEMORY Données de SEQUENCER qui excèdent la capacité du SEQUENCER chez PR700/PR900 (30.000 notes)

- Compatibilité avec les données de **PR250/PR350**, **PR270/PR370**, **PR207/PR307** et Série **PR**: point notable

Fonctions qui ne seront pas reproduites correctement par manque de fonctions dans le PR700/PR900	Réglages de la balance de volume en dualité pour chaque sonorité
---	--

- Les parties de reproduction **RKB** et **LKB** sont fournies dans le **PR700/PR900** pour assurer la compatibilité avec les parties **RIGHT** et **LEFT SEQUENCER**. Cependant, ces parties ne peuvent pas être enregistrées ou éditées.

sx-PR700/sx-PR900

Technics

Weergave van Technics diskettes

- De PR700/PR900 kan diskette-gegevens weergeven van de volgende instrument-modellen:

PR250/PR350	PR270/PR370	PR207/PR307	PR-serie	KN3000
-------------	-------------	-------------	----------	--------

- De volgende gegevens zijn compatibel:

COMPOSER gegevens
SEQUENCER gegevens
Registratie-gegevens (paneel en PANEL MEMORY gegevens)

- Functies waarmee de PR700/PR900 niet is uitgerust, zijn niet compatibel. Indien dergelijke functies in de COMPOSER, SEQUENCER of registratie-gegevens op de diskette voorkomen, zullen deze niet juist worden weergegeven.
- Bij sommige geluiden kan de weergave-octaf verschillen van de opname-octaf.
- De vastgelegde configuraties van de DIGITAL REVERB en het DSP EFFECT verschillen van die van andere modellen wat betekent dat enkel het type effect correspondeert.

- Compatibiliteit met KN300 diskette-gegevens: belangrijke punten

De functies die niet beschikbaar zijn in de PR700/PR900 worden niet juist gereproduceerd.	MEMORY SOUND, USER DRUMS en gegevens die van deze functies gebruik maken <ul style="list-style-type: none">• MEMORY SOUND wordt weergegeven in het Grand Piano geluid, USER DRUMS in de Standard KIT geluiden.
De functies die een andere configuratie hebben dan in de PR700/PR900 worden niet juist gereproduceerd.	MANUAL SEQUENCE PADS, SOUND ARRANGER en gegevens die van deze functies gebruik maken
Aangezien het aantal geheugenbanken en de geheugencapaciteit van de PR700/PR900 kleiner is, kunnen de volgende gegevens niet worden geladen:	MUSIC STYLE ARRANGER
	KN3000: B-3 t/m C-8 van het PANEL MEMORY
	SEQUENCER gegevens die de capaciteit van de PR700/PR900 SEQUENCER (30.000 noten) overschrijden

- Compatibiliteit met PR250/PR350, PR270/PR370, PR207/PR307 en PR-serie diskette-gegevens: belangrijke punten

De functies die niet beschikbaar zijn in de PR700/PR900 worden niet juist gereproduceerd.	Opgenomen dubbele balans-instellingen van de geluiden
---	---

- De RKB en LKB weergavedelen zijn aanwezig op de PR700/PR900 in verband met de compatibiliteit met de RIGHT en LEFT SEQUENCER sporen. Deze delen kunnen echter niet worden opgenomen of bewerkt.

sx-PR700/sx-PR900

Technics

Wiedergabe von Technics-Disketten

- Die Wiedergabe von Diskettendaten der folgenden Instrumenten-Modelle kann über den PR700/PR900 erfolgen:

PR250/PR350	PR270/PR370	PR207/PR307	PR-Serie	KN3000
-------------	-------------	-------------	----------	--------

- Die folgenden Daten sind kompatibel:

COMPOSER-Daten
SEQUENCER-Daten
Registrierungsdaten (Bedienfeld- und PANEL MEMORY-Daten)

- Daten für am PR700/PR900 nicht vorhandene Funktionen sind nicht kompatibel. Wenn diese ungültigen Funktionen in den COMPOSER-, SEQUENCER- oder Registrierungsdaten einer Diskette enthalten sind, können sie nicht einwandfrei wiedergegeben werden.
- Für einige Klänge ist die Wiedergabe-Oktave von der aufgenommenen Oktave verschieden.
- Die festen Konfigurationen von DIGITAL REVERB und DSP EFFECT unterscheiden sich von den Werten anderer Modelle; aus diesem Grund stimmt nur der Effekt-Typ überein.

- Kompatibilität mit Disketten-Daten des KN3000: wichtige Punkte

Diese Funktionen, die am PR700/PR900 nicht vorhanden sind, werden nicht einwandfrei ausgeführt.	MEMORY SOUND, USER DRUMS und alle Daten, die diese Funktionen verwenden. <ul style="list-style-type: none"> MEMORY SOUND wird im Grand Piano-Klang, und USER DRUMS im Standard-KIT-Klang erzeugt.
Diese Funktion, deren Konfiguration am PR700/PR900 unterschiedlich ist, wird nicht einwandfrei ausgeführt.	MANUAL SEQUENCE PADS, SOUND ARRANGER und alle Daten, die diese Funktionen verwenden.
Bedingt durch die geringere Anzahl von Reihen und der kleineren Speicherkapazität im PR700/PR900 können die folgenden Daten nicht geladen werden:	MUSIC STYLE ARRANGER KN3000: B-3 bis C-8 des PANEL MEMORY SEQUENCER-Daten, bei denen die Kapazität des PR700/PR900 SEQUENCER (30.000 Noten) überschritten wird

- Kompatibilität mit Disketten-Daten der Modelle PR250/PR350, PR270/PR370, PR207/PR307 und der PR-Serie: wichtige Punkte

Diese Funktionen, die am PR700/PR900 nicht vorhanden sind, werden nicht einwandfrei ausgeführt.	Aufgenommene Dual-Balance-Einstellungen jedes Klangs.
---	---

- Die RKB- und LKB-Wiedergabebereiche sind am PR700/PR900 vorhanden, um eine Kompatibilität mit den RIGHT und LEFT SEQUENCER-Spuren zu gewährleisten. Diese Bereiche können allerdings nicht aufgenommen oder editiert werden.