



# Panasonic®

## Operating Instructions Air Conditioner



### Model No.

#### Indoor Unit

**CS-RE9PKE-3**

**CS-RE12PKE-3**

**CS-RE15PKE-3**

#### Outdoor Unit

**CU-RE9PKE-3**

**CU-RE12PKE-3**

**CU-RE15PKE-3**

### Operating Instructions

2-9

Thank you for purchasing Panasonic Air Conditioner. Before operating the unit, read these operating instructions thoroughly and keep them for future reference. Installation Instructions attached for authorized dealer or specialist.

### Mode d'emploi

10-17

Nous vous remercions d'avoir porté votre choix sur un climatiseur Panasonic. Avant d'utiliser l'appareil, lisez ce mode d'emploi dans son intégralité et conservez-le pour toute référence ultérieure. Instructions d'installation ci-jointes pour un revendeur ou spécialiste agréé.

### Manual de Instrucciones

18-25

Muchas gracias por elegir una unidad de aire acondicionado Panasonic. Antes de utilizar la unidad, sírvase leer atentamente estas instrucciones de funcionamiento y conservarlas como futuro elemento de consulta. Instrucciones de Instalación adjuntas para el distribuidor autorizado o especialista.

### Istruzioni di funzionamento

26-33

Grazie per aver acquistato un climatizzatore Panasonic. Prima di utilizzare l'unità si prega di leggere attentamente le istruzioni e di conservare questo opuscolo per potervi fare riferimento in futuro. Istruzioni sull'installazione allegate per il concessionario autorizzato o specialista.

### Manual de Utilização

34-41

Obrigado por adquirir o Ar Condicionado da Panasonic. Antes de ligar a unidade, leia cuidadosamente este manual de utilização e guarde-o para futura referência. Instruções de Instalação em anexo para representante autorizado ou especialista.

### Инструкции за работа

42-49

Благодарим Ви, че закупихте климатик Panasonic. Преди да задействате климатика, прочетете внимателно инструкциите за употреба и ги запазете за бъдещи справки. Приложени са указания за монтаж, предназначени за използване от официален представител или специалист.

English

Français

Español

Italiano

Português

Български



F568946



# Quick guide

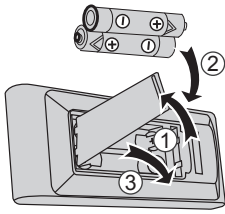

## Inserting the batteries

- ① Remove the battery cover
- ② Insert AAA or R03 batteries (can be used ~ 1 year)
- ③ Close the cover

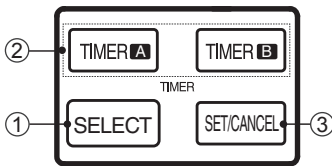

## TIMER setting

- ① Press SELECT
- ② Set the time
- ③ Confirm

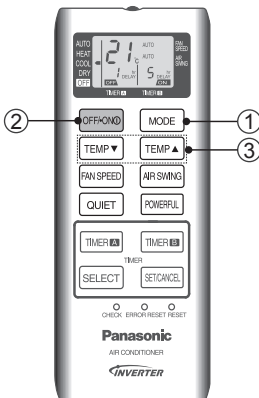

## Basic operation

- ① Select the desired mode



- ② Start/stop the operation



• Please note that the OFF indication is as follows:



- ③ Select the desired temperature

- Selection range : 16°C ~ 30°C.
- Operating the unit within the recommended temperature may save energy.
- HEAT: 20°C ~ 24°C .
- COOL: 26°C ~ 28°C.
- DRY : 1°C ~ 2°C lower than room temperature.

- Use remote control within 8m from the remote control receiver of the indoor unit.

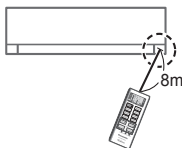

The illustrations in this manual are for explanation purposes only and may differ from the actual unit. They are subject to change without notice for future improvement.



## Table of contents

Safety precautions.....	4-5
How to use.....	6-7
Cleaning instructions.....	8
Troubleshooting.....	9
Product Specification.....	50
Information.....	54

### Accessories

- Remote Control
- AAA or R03 batteries × 2

English

# Safety precautions

To prevent personal injury, injury to others or property damage, please comply with the following:  
 Incorrect operation due to failure to follow instructions below may cause harm or damage, the seriousness of which is classified as below:

	<b>WARNING</b>	This sign warns of death or serious injury.
---	----------------	---

	<b>CAUTION</b>	This sign warns of injury or damage to property.
---	----------------	--

The instructions to be followed are classified by the following symbols:

	This symbol denotes an action that is <b>PROHIBITED</b> .
---	---

 	These symbols denote actions <b>COMPULSORY</b> .
 	

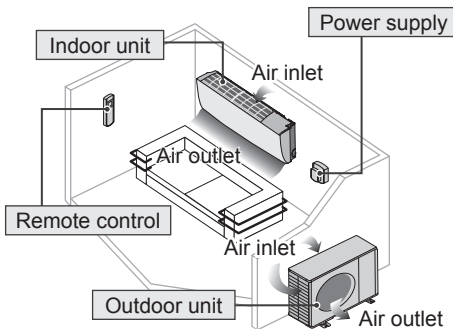

## WARNING

### Indoor unit and outdoor unit

 This appliance is not intended for use by persons (including children) with reduced physical, sensory or mental capabilities, or lack of experience and knowledge, unless they have been given supervision or instruction concerning use of the appliance by a person responsible for their safety. Children should be supervised to ensure that they do not play with the appliance.

Please consult authorised dealer or specialist to clean the internal parts, repair, install, remove and reinstall the unit. Improper installation and handling will cause leakage, electric shock or fire.

Confirm with authorised dealer or specialist on usage of any specified refrigerant type. Using refrigerant type other than the specified may cause product damage, burst and injury etc.

 Do not install the unit in a potentially explosive or flammable atmosphere. Failure to do so could result in fire.

Do not insert your fingers or other objects into the air conditioner indoor or outdoor unit, rotating parts may cause injury. 

Do not touch the outdoor unit during lightning, it may cause electric shock.



Do not expose yourself directly to cold air for a long period to avoid excess cooling.

Do not sit or step on the unit, you may fall down accidentally. 

### Remote control

 Do not allow infants and small children to play with the remote control to prevent them from accidentally swallowing the batteries.

### Power supply

 Do not use a modified cord, joint cord, extension cord or unspecified cord to prevent overheating and fire.  

To prevent overheating, fire or electric shock:

- Do not share the same power outlet with other equipment.
- Do not operate with wet hands.
- Do not over bend the power supply cord.
- Do not operate or stop the unit by inserting or pulling out the power plug.

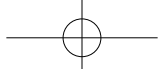

**WARNING****Power supply**

If the supply cord is damaged, it must be replaced by the manufacturer, service agent or similarly qualified persons in order to avoid a hazard.

It is strongly recommended to be installed with Earth Leakage Circuit Breaker (ELCB) or Residual Current Device (RCD) to prevent electric shock or fire.

To prevent overheating, fire or electric shock:



- Insert the power plug properly.
- Dust on the power plug should be periodically wiped with a dry cloth.

Stop using the product if any abnormality/failure occurs and disconnect the power plug or turn off the power switch and breaker. (Risk of smoke/fire/electric shock) Examples of abnormality/failure

- The ELCB trips frequently.
- Burning smell is observed.
- Abnormal noise or vibration of the unit is observed.
- Water leaks from the indoor unit.
- Power cord or plug becomes abnormally hot.
- Fan speed cannot be controlled.
- The unit stops running immediately even if it is switched on for operation.
- The fan does not stop even if the operation is stopped.

Contact your local dealer immediately for maintenance/repair.

Replacement or installation of power plugs shall be performed by authorized/qualified personnel only. The wires in this mains lead are coloured in accordance with the following code:

Terminals	wires	colours (IEC Standard)
<b>L</b> 	live	brown
<b>N</b> 	neutral	blue
<b>E</b> 	earth	green-yellow

Wiring colour may vary depending on a country wiring code's standard.



This equipment must be earthed to prevent electrical shock or fire.



Prevent electric shock by switching off the power supply and unplug:



- Before cleaning or servicing,
- When extended non-use, or
- During abnormally strong lightning activity.

**CAUTION****Indoor unit and outdoor unit**

Do not wash the indoor unit with water, benzene, thinner or scouring powder to avoid damage or corrosion at the unit.



Do not use for preservation of precise equipment, food, animals, plants, artwork or other objects. This may cause quality deterioration, etc.

Do not use any combustible equipment in front of the airflow outlet to avoid fire propagation.

Do not expose plants or pet directly to airflow to avoid injury, etc.

Do not touch the sharp aluminium fin, sharp parts may cause injury.



Do not switch ON the indoor unit when waxing the floor. After waxing, aerate the room properly before operating the unit.

Do not install the unit in oily and smoky areas to prevent damage to the unit.

Do not dismantle the unit for cleaning purpose to avoid injury.

Do not step onto an unstable bench when cleaning the unit to avoid injury.

Do not place a vase or water container on the unit. Water may enter the unit and degrade the insulation. This may cause an electric shock.

Do not open window or door for long time during COOL/DRY mode operation.



Prevent water leakage by ensuring drainage pipe is:

- Connected properly,
- Kept clear of gutters and containers, or
- Not immersed in water

After a long period of use or use with any combustible equipment, aerate the room regularly.

After a long period of use, make sure the installation rack does not deteriorate to prevent the unit from falling down.

**Remote control**

Do not use rechargeable (Ni-Cd) batteries. It may damage the remote control.



To prevent malfunction or damage of the remote control:

- Remove the batteries if the unit is not going to be used for a long period of time.
- New batteries of the same type must be inserted following the polarity stated.

**Power supply**

Do not disconnect the plug by pulling the cord to prevent electric shock.



# How to use

**OFF/ON** To turn on or off the unit

**TEMP** To set temperature

**FAN SPEED** To select fan speed (5 options)

(Remote control display)

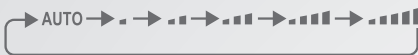

- For AUTO, the indoor fan speed is automatically adjusted according to the operation mode.

**QUIET** To enjoy quiet environment

- This setting provides a quiet environment by reducing the airflow noise.



Remote control receiver and indicator

POWER	(GREEN)
TIMER	(ORANGE)
QUIET	(GREEN)
POWERFUL	(RED)

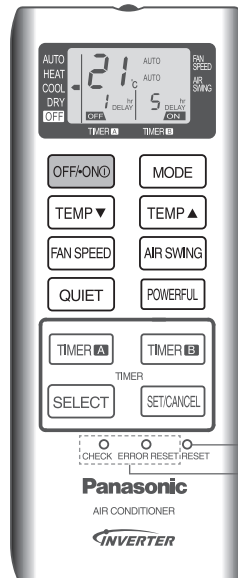

Press to restore the remote control to default setting.  
Not used in normal operations.

## To adjust horizontal airflow direction

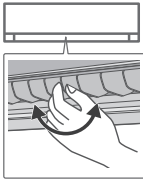

• Manually adjustable.

## Auto OFF/ON button

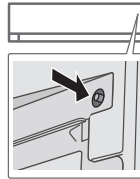

- Use when remote control is misplaced or a malfunction occurs. Raise the front panel:
- To use in AUTO mode, press the button once.
  - To use in COOL mode, press and hold the button until 1 beep is heard, then release.
  - To use in HEAT mode, press and hold the button until 1 beep is heard, then release. And press again until 2 beeps, then release.
  - Press the button again to turn off.

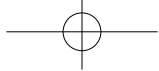

## MODE To select operation mode

### AUTO mode - For your convenience

- During operation mode selection the power indicator blinks.
- Unit selects the operation mode according to the indoor intake temperature and remote control temperature.

### HEAT mode - To enjoy warm air

- In heat mode, it may take a while for the unit to warm up.

### COOL mode - To enjoy cool air

- To reduce power consumption during COOL mode, use curtains to screen off sunlight and outdoor heat.

### DRY mode - To dehumidify the environment

- Unit operates at low fan speed to give a gentle cooling operation.

## AIR SWING To adjust vertical airflow direction (5 options)

(Remote control display)



- Keeps the room ventilated.
- In COOL mode, if AUTO is set, the louver swings up/down automatically.
- In HEAT mode, if AUTO is set, the horizontal louver fix at predetermined position.
- Do not adjust the louver by hand.

## POWERFUL To achieve temperature quickly

- This setting enables the desired set temperature to be reached quickly.

NOTE: POWERFUL and QUIET operations can not be activated at the same time.

## To set the timer

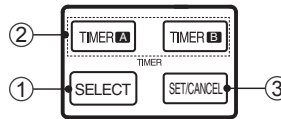

- To turn ON the unit at a preset time. Set the timer while the unit is OFF.
- To turn OFF the unit at a preset time. Set the timer while the unit is ON.

- ① Press once to select timer.
- ② Press **TIMER A** repeatedly to set your desired time.
- ③ Press once to confirm.

- To turn ON and then turn OFF the unit at preset time. Set the timers while unit is OFF.
- To turn OFF and then turn ON the unit at preset time. Set the timers while unit is ON.

- ① Press twice to select timers.
- ② Press **TIMER A** / **TIMER B** repeatedly to set your desired time.
- ③ Press once to confirm.

- Press the **SET/CANCEL** button again to cancel timer operation.
- The timer will also be cancelled when you press **OFF/ON** button.
- The timer indicator of indoor unit will light up during timer operation.
- When ON Timer is set, the unit may start earlier before the actual set time in order to achieve the desired temperature on time.
- If timer is cancelled manually or due to power failure, you can restore the timer again by repeating steps above (once power is resumed).

## Operation conditions

Use this air conditioner under the following temperature range.

Temperature(°C)		Indoor		Outdoor	
		*DBT	*WBT	*DBT	*WBT
COOLING	Maximum	32	23	43	26
	Minimum	16	11	-10	11
HEATING	Maximum	30	-	24	18
	Minimum	16	-	-15	-6

DBT: Dry bulb temperature  
WBT: Wet bulb temperature

NOTICE: • This model is not suitable for 24 hours non-stopping operation in heating mode below -15°C. When the outdoor temperature is below -15°C and you use this model out of above conditions, the outdoor unit might be frozen up and stop operation for protection control.



# Cleaning instructions

To ensure optimal performance of the unit, cleaning has to be carried out at regular intervals.

- Switch off the power supply and unplug before cleaning.
- Do not touch the aluminium fin, sharp parts may cause injury.
- Do not use benzene, thinner or scouring powder.
- Use only soap ( $\approx$  pH 7) or neutral household detergent.
- Do not use water hotter than 40°C.

## Indoor unit

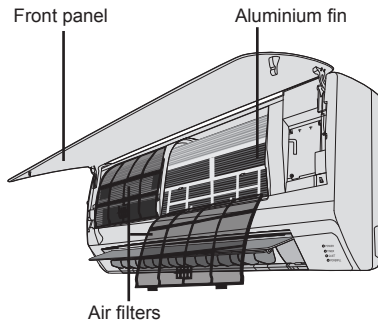

### Indoor unit

Wipe the unit gently with a soft, dry cloth.



### Air filters

Clean the filter regularly

- Wash/rinse the filters gently with water to avoid damage to the filter surface.
- Dry the filters thoroughly under shade, away from fire or direct sunlight.
- Replace any damaged filters.



### Front panel

Wash gently and dry.

#### Remove the front panel

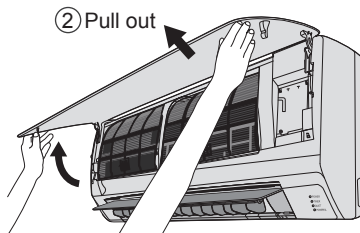

① Raise

#### Remove air filter

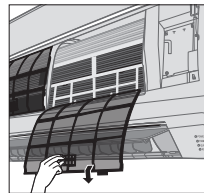

#### Attach air filter

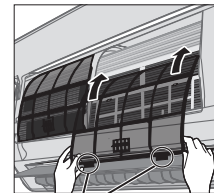

Insert into the unit

#### Close it securely

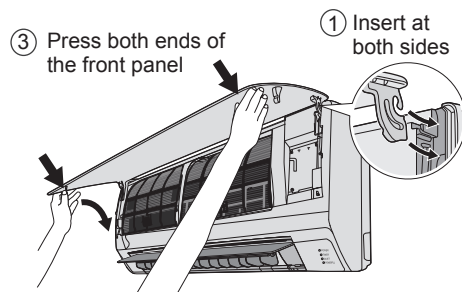

② Close down

#### For seasonal inspection after extended non-use

- Checking of remote control batteries.
- No obstruction at air inlet and air outlet vents.
- Use Auto OFF/ON button to select Cooling/Heating operation. After 15minutes of operation, it is normal to have the following temperature difference between air inlet and air outlet vents:  
Cooling:  $\geq 8^{\circ}\text{C}$       Heating:  $\geq 14^{\circ}\text{C}$

#### For extended non-use

- Turn off the power supply and unplug.
- Remove the remote control batteries.

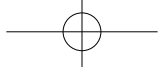

# Troubleshooting

The following symptoms do not indicate malfunction.

Symptom	Cause
Mist emerges from indoor unit.	• Condensation effect due to cooling process.
Water flowing sound during operation.	• Refrigerant flow inside the unit.
The room has a peculiar odour.	• This may due to damp smell emitted by the wall, carpet, furniture or clothing.
Indoor fan stops occasionally during automatic fan speed setting.	• This helps to remove the surrounding odours.
Operation is delayed a few minutes after restarting.	• The delay is a protection to the unit's compressor.
Outdoor unit emits water/steam.	• Condensation or evaporation occurs on pipes.
The unit operates automatically when power is resumed after a power failure.	• It is the Auto Restart function of the unit. Operation will be restarted automatically under the previous operation mode and air flow direction when power is resumed as the operation is not stopped by remote control.
Indoor fan stops occasionally during heating operation.	• To avoid unintended cooling effect.
Power indicator blinks before the unit is switched on.	• This is a preliminary step in preparation for the operation when the ON timer has been set.
Cracking sound during operation.	• Changes of temperature cause the expansion/contraction of the unit.

Check the following before calling for servicing.

Symptom	Check
Operation in COOL/HEAT mode is not working efficiently.	<ul style="list-style-type: none"> <li>• Set the temperature correctly.</li> <li>• Close all doors and windows.</li> <li>• Clean or replace the filters.</li> <li>• Clear any obstruction at the air inlet and air outlet vents.</li> </ul>
Noisy during operation.	<ul style="list-style-type: none"> <li>• Check if the unit has been installed at an incline.</li> <li>• Close the front panel properly.</li> </ul>
Remote control does not work. (Display is dim or transmission signal is weak.)	<ul style="list-style-type: none"> <li>• Insert the batteries correctly.</li> <li>• Replace weak batteries.</li> </ul>
The unit does not work.	<ul style="list-style-type: none"> <li>• Check if the circuit breaker is tripped.</li> <li>• Check if timers have been set.</li> </ul>
The unit does not receive the signal from the remote control.	<ul style="list-style-type: none"> <li>• Make sure the receiver is not obstructed.</li> <li>• Certain fluorescent lights may interfere with signal transmitter. Please consult authorised dealer.</li> </ul>

## NON SERVICEABLE CRITERIAS

TURN OFF POWER SUPPLY AND UNPLUG then please consult authorised dealer under the following conditions:

- Abnormal noise during operation.
- Water/foreign particles have entered the remote control.
- Water leaks from Indoor unit.
- Circuit breaker switches off frequently.
- Power cord becomes unnaturally warm.
- Switches or buttons are not functioning properly.
- The timer indicator blinks and the unit can not be operated

## The unit stops and the TIMER indicator blinks.

Use remote control to retrieve error code.

1 Press for 5 seconds.

2 Press until you hear beep sound, then jot down the error code.

3 Press for 5 seconds to quit checking.

4 Turn the unit off and reveal the error code to authorized dealer.

# Guide rapide

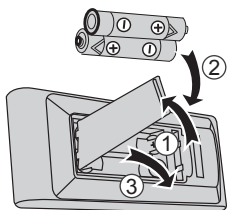

## Insérer les piles

- ① Retirer le couvercle de la batterie
- ② Placez des piles AAA ou R03 (valables environ 1 an)
- ③ Fermez le couvercle

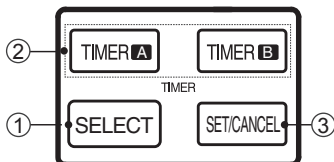

## Réglage du MINUTEUR

- ① Appuyez sur SÉLECTIONNER
- ② Réglez l'heure
- ③ Confirmez

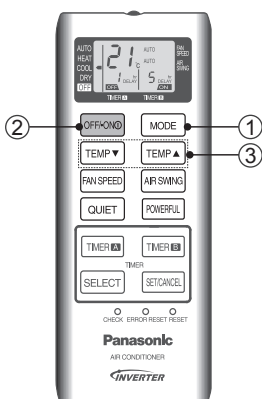

## Fonctionnement de base

- ① Sélectionnez le mode de fonctionnement souhaité  
**AUTO** → **HEAT** → **COOL** → **DRY**

- ② Mettez l'appareil sous/hors tension



• Veuillez noter que l'indication OFF est la suivante :



- ③ Sélectionnez la température souhaitée

- Plage de sélection : 16 °C ~ 30 °C.
- Faire fonctionner l'unité dans la fourchette des températures recommandées peut économiser de l'énergie.
- CHALEUR : 20 °C ~ 24 °C.
- REFROIDISSEMENT : 26 °C ~ 28 °C.
- SEC : 1 °C ~ 2 °C inférieur à la température de la pièce.

- Utilisez la télécommande à moins de 8m du récepteur de la télécommande de l'unité intérieure.

Les illustrations de ce mode d'emploi sont fournies à titre d'exemple uniquement et peuvent présenter des différences par rapport à l'appareil proprement dit. Elles peuvent être modifiées sans préavis à des fins d'amélioration.

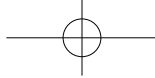

## Table des matières

Consignes de sécurité.....	12-13
Comment utiliser.....	14-15
Instructions de nettoyage.....	16
Dépannage.....	17
Les caractéristiques techniques du produit.....	50
Informations.....	54

### Les accessoires

- La télécommande
- 2 piles AAA ou R03

Français

# Consignes de sécurité

Pour éviter des lésions corporelles, des blessures à autrui ou des dommages matériels, veuillez vous conformer aux instructions suivantes :

Un fonctionnement incorrect dû au non-respect des instructions ci-dessous peut causer du mal ou des dommages, lesquels sont classés par degré de gravité ci-dessous :

	<p><b>AVERTISSEMENT</b></p> <p>Ce symbole signale la présence d'un danger pouvant provoquer des blessures graves ou mortelles.</p>
---	--

	<p><b>ATTENTION</b></p> <p>Ce symbole signale la présence d'un danger pouvant provoquer des blessures corporelles ou des dégâts matériels.</p>
---	--

Les instructions à respecter sont classées d'après les symboles suivants:

	<p>Ce symbole désigne une action <b>INTERDITE</b>.</p>
---	--

	<p>Ces symboles indiquent des actions <b>OBLIGATOIRES</b>.</p>
---	--

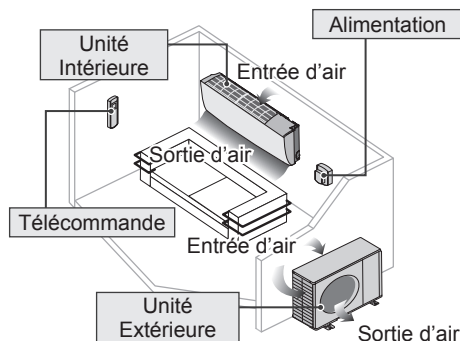

## AVERTISSEMENT

### Unité intérieure et unité extérieure



Cet appareil n'est pas conçu pour être utilisé par des personnes (y compris les enfants) aux capacités physiques, sensorielles ou mentales diminuées, ou manquant d'expérience ou de connaissances, sauf si une personne responsable de leur sécurité leur a expliqué le fonctionnement de l'appareil et les garde sous surveillance. Les enfants doivent être supervisés afin qu'ils ne jouent pas avec l'appareil.

Veuillez consulter un revendeur agréé ou un spécialiste pour nettoyer les éléments internes, ainsi que pour réparer, installer, retirer et réinstaller l'unité. Une installation ou une manipulation inappropriée peut entraîner une fuite, ou un risque d'électrocution ou d'incendie.

Confirmez avec un revendeur ou spécialiste agréé l'utilisation de tout type de fluide frigorigène spécifié. L'utilisation d'un type de fluide frigorigène différent de celui qui est spécifié peut causer des dommages, un éclatement du produit, des blessures, etc.



N'installez pas l'appareil dans une atmosphère potentiellement explosive ou inflammable. Sinon, il y a un risque d'incendie.

N'insérez jamais vos doigts ou des objets dans l'unité intérieure ou extérieure du climatiseur, les parties tournantes peuvent causer des blessures.



Ne touchez pas l'unité extérieure au cours d'un orage, cela pourrait provoquer un choc électrique.

Ne vous exposez pas directement à l'air froid durant une longue période.

Ne vous asseyez pas et ne montez pas sur l'unité, vous risquez de tomber accidentellement.



### Télécommande



Maintenez la télécommande hors de portée des bébés et des enfants pour éviter qu'ils n'avalent accidentellement les piles.

### Alimentation



N'utilisez pas de câble modifié, de raccord de câble, de rallonge de câble ou de câble non spécifié afin d'éviter toute surchauffe ou tout incendie.



Afin d'éviter toute surchauffe, risque d'incendie ou d'électrocution :

- Ne pas partager la même prise de courant avec d'autres équipements.
- Ne pas utiliser l'appareil avec des mains mouillées.
- Ne pliez pas le cordon d'alimentation de manière abusive.
- Ne pas mettre en marche ou arrêter l'appareil en le branchant ou en le débranchant de la prise de courant.



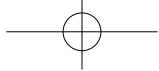

## AVERTISSEMENT

### Alimentation



Si le câble fourni est endommagé, il doit être remplacé par le fabricant, l'agent de service ou par des personnes aux qualifications équivalentes de façon à éviter tout risque.

Il est fortement conseillé d'installer un disjoncteur-détecteur de fuite à la terre (DDFT) ou un dispositif à courant résiduel (DCR) afin d'éviter un choc électrique ou un incendie.

Afin d'éviter toute surchauffe, risque d'incendie ou d'électrocution :

- Branchez correctement la prise de courant.
- La poussière accumulée sur la prise d'alimentation doit être enlevée régulièrement à l'aide d'un chiffon sec.

Arrêtez d'utiliser le produit si une des pannes ou symptômes se produisent et déconnectez le cordon d'alimentation ou disjoncez la prise.

(Risque de fumée / incendie / électrocution)

Exemple d'anomalie / panne

- Le disjoncteur saute régulièrement.
- Un odeur de brûlé se dégage.
- L'unité produit un bruit ou une vibration anormale.
- De l'eau fuit de l'unité intérieure.
- Le cordon d'alimentation ou la prise deviennent anormalement chauds.
- La vitesse du ventilateur ne peut pas être contrôlée.
- L'unité s'arrête immédiatement même si elle est allumée.
- Le ventilateur ne s'arrête pas après extinction. Contactez immédiatement votre revendeur local pour l'entretien / les réparations.

Le remplacement ou l'installation de prises de courant doit être réalisé par du personnel agréé / qualifié. Les câbles d'alimentation sont colorés en accord avec le code suivant :

Bornes	fil	couleurs (Standard IEC)
L	Rouge	sous-tension marron
N	Noir	neutre bleu
E	Vert/Jaune	terre vert-jaune

La couleur du câblage peut varier en fonction du standard de code de câblage de chaque pays.



Ce matériel doit être mis à la terre pour éviter tout choc électrique ou incendie.



Évitez les chocs électriques en coupant l'alimentation et en débranchant :

- Avant le nettoyage ou l'entretien.
- Lors d'une non-utilisation prolongée, ou
- En cas de très violents éclairs.



## ATTENTION

### Unité intérieure et unité extérieure



Ne lavez pas l'unité intérieure avec de l'eau, de l'essence, du diluant ou de la poudre à récurer afin de ne pas entraîner de dommages ou de corrosion sur l'unité.



N'utilisez pas l'unité pour préserver des équipements, de la nourriture, des animaux, des plantes, des oeuvres d'art ou autres objets. Ceci peut entraîner une dégradation du produit, etc.

N'utilisez pas de matériel inflammable face à la sortie d'air afin d'éviter toute propagation d'incendie.

N'exposez pas les plantes et animaux domestiques directement au flux d'air afin d'éviter tout risque de blessure.

Ne touchez pas l'ailette pointue d'aluminium, les parties pointues peuvent causer des dommages.



Ne mettez pas l'unité intérieure sous tension lorsque vous cirez le sol. Après le cirage, aérez suffisamment la pièce avant de faire fonctionner l'unité.

N'installez pas l'unité dans un environnement huileux ou enfumé afin d'éviter d'endommager l'unité.

Afin d'éviter tout risque de blessure, ne démontez pas l'unité lors du nettoyage.

Pour éviter tout risque de blessure, ne montez pas sur un tabouret instable lorsque vous nettoyez l'unité.

Ne placez pas de vase ou de récipient d'eau sur l'unité. L'eau peut pénétrer dans l'unité et endommager l'isolation. Ceci peut provoquer un choc électrique.

N'ouvrez pas de fenêtre ou de porte pendant un trop long moment lorsque vous êtes en mode de fonctionnement COOL/DRY.



Évitez les fuites d'eau en vous assurant que le tuyau d'évacuation est :

- Bien connecté,
- Gardé éloigné des gouttières et des conteneurs, ou
- Ne se trouve pas immergé dans l'eau.

Après une période prolongée d'utilisation avec du matériel inflammable, aérez la pièce régulièrement.

Après une longue période d'utilisation, assurez-vous que les montants de l'installation ne se sont pas détériorés afin d'éviter toute chute de l'unité.

### Télécommande



N'utilisez pas de piles rechargeables (Ni-Cd). Cela pourrait endommager la télécommande.



Afin d'éviter un mauvais fonctionnement ou d'endommager la télécommande :

- Enlevez les piles si l'appareil ne doit pas être utilisé pendant une période prolongée.
- Les nouvelles batteries de type similaire doivent être insérées en respectant les polarités indiquées.

### Alimentation



Ne débranchez pas la prise en tirant sur le câble afin d'éviter tout choc électrique.



# Comment utiliser

OFF/ON

**Pour allumer ou éteindre l'unité**

TEMP ▼

TEMP ▲

**Pour régler la température**

FAN SPEED

**Pour sélectionner la vitesse du ventilateur (5 options)**

(Affichage de la télécommande)

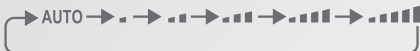

- Pour AUTO, la vitesse du ventilateur intérieur est automatiquement ajustée en fonction du mode de fonctionnement.

QUIET

**Pour obtenir un environnement silencieux**

- Ce réglage fournit un environnement silencieux en réduisant le bruit du flux d'air.



Récepteur de la télécommande et voyant

POWER	(VERT)
TIMER	(ORANGE)
QUIET	(VERT)
POWERFUL	(ROUGE)

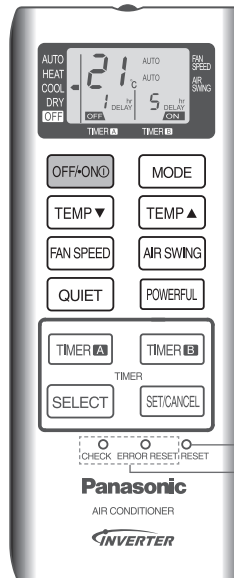

Appuyez sur cette touche pour restaurer les paramètres par défaut de la télécommande.

Non utilisé dans les opérations normales.

## Pour régler le sens du flux d'air horizontal

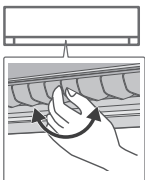

• Réglable manuellement.

## Touche Auto OFF/ON (MARCHE /ARRÊT)

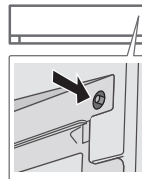

Utilisez-la lorsque la télécommande est égarée ou lorsqu'il se produit un dysfonctionnement. Soulevez le panneau frontal:

- Pour une utilisation en mode AUTO, appuyez une seule fois sur la touche.
- Pour une utilisation en mode COOL, appuyez et maintenez la touche enfoncée jusqu'à entendre un bip sonore et puis relâchez.
- Pour une utilisation en mode CHAUFFAGE, appuyez et maintenez la touche enfoncée jusqu'à entendre un bip sonore, puis relâchez. Et appuyez de nouveau jusqu'à entendre 2 bips, puis relâchez.
- Appuyez de nouveau sur la touche pour éteindre.

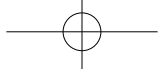

MODE

## Pour sélectionner un mode de fonctionnement

### Mode AUTO - Selon vos préférences

- Lors de la sélection du mode de fonctionnement, le voyant d'alimentation clignote.
- L'unité sélectionne le mode de fonctionnement en fonction de la température intérieure et de la température désirée affichée sur la télécommande.

### Mode de CHAUFFAGE - Pour un air chaud

- En mode chauffage, l'unité peut prendre un certain temps à préchauffer.

### Mode de REFROIDISSEMENT - Pour un air frais

- Pour réduire la consommation d'énergie en mode COOL, utilisez des rideaux pour protéger de la lumière du soleil et de la chaleur extérieure.

### Mode DÉSHUMIDIFICATION - Pour déshumidifier l'atmosphère

- L'unité fonctionne en vitesse lente du ventilateur pour fournir un refroidissement en douceur.

AIR SWING

## Pour régler le sens du flux d'air vertical (5 options)

(Affichage de la télécommande)



- Maintient la salle aérée.
- En mode COOL, si vous avez réglé sur AUTO, la persienne pivote de haut en bas automatiquement.
- En mode CHAUFFAGE, si AUTO est défini, le volet horizontal se fixe dans une position prédéterminée.
- Ne réglez pas la persienne à la main.

POWERFUL

## Pour atteindre rapidement la température souhaitée

- Ce réglage permet d'atteindre rapidement la température réglée souhaitée.

REMARQUE : Les fonctions POWERFUL et QUIET ne peuvent être activées en même temps.

## Pour régler l'heure

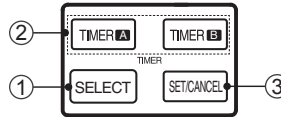

- Pour ALLUMER l'unité à une heure déterminée. Réglez le minuteur lorsque l'unité est sur OFF (ARRÊT).
  - Pour ÉTEINDRE l'unité à une heure déterminée. Réglez le minuteur lorsque l'unité est sur ON (MARCHE).
- ① Appuyez juste une fois pour sélectionner le minuteur.
  - ② Appuyez sur [TIMER A] de façon répétée pour régler l'heure désirée.
  - ③ Appuyez une seule fois pour confirmer.

- Pour ALLUMER et ensuite ÉTEINDRE l'unité à une heure déterminée. Réglez les minuteurs lorsque l'unité est sur OFF (ARRÊT).
- Pour ÉTEINDRE et ensuite ALLUMER l'unité à une heure déterminée. Réglez les minuteurs lorsque l'unité est ALLUMÉE.

- ① Appuyez deux fois pour sélectionner les minuteurs.
- ② Appuyez sur [TIMER A] / [TIMER B] de façon répétée pour régler l'heure désirée.
- ③ Appuyez une seule fois pour confirmer.

- Appuyez à nouveau sur la touche [SET/CANCEL] pour annuler le fonctionnement de la minuterie.
- Le minuteur sera également annulé lorsque vous appuierez sur la touche [OFF/ON].
- Le voyant du minuteur de l'unité intérieure sera allumé lorsque le minuteur sera en fonctionnement.
- Lorsque la minuterie MISE EN MARCHE est réglée, l'unité peut démarrer avant le temps défini réel afin d'atteindre la température désirée à temps.
- Si le minuteur est annulé manuellement ou à cause d'une panne de courant, vous pouvez restaurer le minuteur en répétant les étapes décrites plus haut (une fois que le courant est rétabli).

Comment utiliser

Français

## Condition d'utilisation

Utilisez ce climatiseur en respectant la plage de températures suivante.

Température (°C)		Intérieure		Extérieure	
		*DBT	*WBT	*DBT	*WBT
REFROIDISSEMENT	Maximum	32	23	43	26
	Minimum	16	11	-10	11
RECHAUFFEMENT	Maximum	30	-	24	18
	Minimum	16	-	-15	-6

DBT: Température sèche  
WBT: Température humide

ATTENTION : • Ce modèle ne convient pas à un fonctionnement en continu 24h/24 en mode de chauffage en cas de températures inférieures à -15 °C. Lorsque la température extérieure est inférieure à -15 °C et que vous utilisez ce modèle en dehors des conditions ci-dessus, l'unité extérieure pourrait être gelée et ne plus fonctionner pour le contrôle de protection.

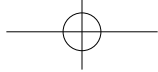

# Instructions de nettoyage

**Pour assurer un fonctionnement optimal de l'unité, un nettoyage devra être effectué à intervalles réguliers.**

- Éteignez la source d'alimentation et débranchez avant de nettoyer.
- Ne touchez pas l'ailette en aluminium, la partie tranchante peut provoquer des blessures.
- N'utilisez pas de benzène, de diluant ou de poudre à récurer.
- Utilisez uniquement du savon (≈ pH7) ou un détergent ménager neutre.
- N'utilisez pas de l'eau dont la température est supérieure à 40 °C.

## Unité intérieure

Frottez délicatement l'appareil avec un chiffon doux et sec.



## Panneau avant

Lavez avec soin et séchez.

### Retirez le panneau frontal

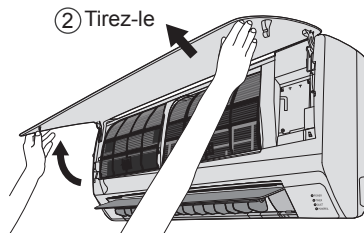

① Soulevez-le

### Fermez-le soigneusement

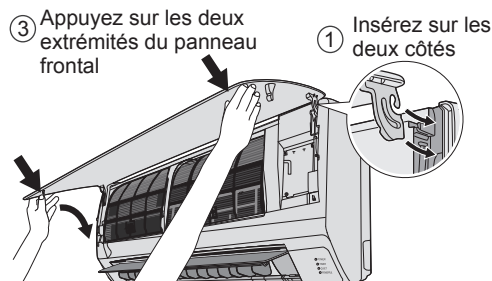

② Refermez

## Unité intérieure

Panneau avant

Ailette en aluminium

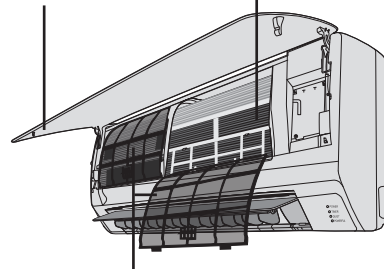

Filtre à air

## Filtre à air

Nettoyez régulièrement les filtres

- Lavez/rincez les filtres avec précaution avec de l'eau afin d'éviter d'endommager leur surface.
- Séchez les filtres soigneusement à l'abri de la lumière, en vous tenant éloigné des flammes ou de la lumière provenant directement du soleil.
- Remplacez tout filtre endommagé.



### Enlevez le filtre à air

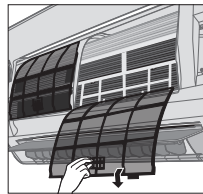

### Attachez le filtre à air

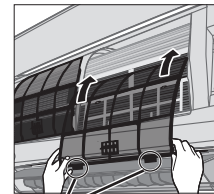

Insérez-le dans l'unité

## Inspection annuelle après une période prolongée d'inutilisation

- Vérifiez que les piles de la télécommande sont en bon état.
- Assurez-vous de l'absence d'obstruction des orifices d'entrée et de sortie d'air.
- Utilisez le bouton automatique d'arrêt et de marche OFF/ON pour choisir l'opération de refroidissement/ réchauffement. Après 15 minutes d'opération, il est normal d'avoir la différence suivante de température entre la prise d'air et la sortie de bouches d'aération:  
Refroidissement: ≥ 8 °C      Chauffage: ≥ 14 °C

### Préparation en cas d'inutilisation prolongée

- Coupez la source d'alimentation et débranchez.
- Retirez les piles de la télécommande.

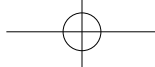

# Dépannage

Les phénomènes suivants ne correspondent pas à un dysfonctionnement.

Phénomène	Cause
De la vapeur se dégage de l'unité intérieure.	<ul style="list-style-type: none"> <li>Il s'agit d'un effet de condensation dû au refroidissement.</li> </ul>
Lors du fonctionnement, vous entendez un bruit d'eau qui coule.	<ul style="list-style-type: none"> <li>Fluide frigorigène à l'intérieur de l'appareil.</li> </ul>
La pièce a une odeur étrange.	<ul style="list-style-type: none"> <li>Il est possible qu'il s'agisse d'une odeur d'humidité provenant du mur, du tapis, d'un meuble ou d'un vêtement.</li> </ul>
En mode de réglage automatique de la vitesse du ventilateur, le ventilateur intérieur s'arrête de temps en temps.	<ul style="list-style-type: none"> <li>Ceci contribue à dissiper les odeurs ambiantes.</li> </ul>
Le fonctionnement est retardé de quelques minutes après le redémarrage.	<ul style="list-style-type: none"> <li>Le ralentissement est une protection du compresseur de l'appareil.</li> </ul>
L'unité extérieure dégage de la vapeur ou de l'eau.	<ul style="list-style-type: none"> <li>De l'eau se condense ou s'évapore dans les tuyaux.</li> </ul>
L'appareil fonctionne automatiquement lorsque le courant est rétabli après une coupure de courant.	<ul style="list-style-type: none"> <li>Il s'agit de la fonction de Remise en Route Automatique de l'appareil. Lorsque le courant est rétabli, et du moment que le fonctionnement n'est pas arrêté par la télécommande, l'appareil se remet automatiquement en route sous le mode de fonctionnement précédent et avec le même sens de circulation d'air que précédemment.</li> </ul>
En mode de chauffage, le ventilateur intérieur s'arrête de temps en temps.	<ul style="list-style-type: none"> <li>Pour éviter un effet de refroidissement indésirable.</li> </ul>
Le voyant de mise sous tension clignote avant que l'unité ne soit mise en route.	<ul style="list-style-type: none"> <li>C'est une étape de préparation préliminaire à la mise en route lorsque la minuterie de départ ON a été réglée.</li> </ul>
Bruit de craquement pendant le fonctionnement.	<ul style="list-style-type: none"> <li>Les fluctuations de température provoquent l'expansion/la contraction de l'appareil.</li> </ul>

Vérifiez les éléments suivants avant de faire appel au service de maintenance.

Phénomène	Vérification
Le fonctionnement en mode COOL/HEAT ne fonctionne pas de manière efficace.	<ul style="list-style-type: none"> <li>Réglez la température correctement.</li> <li>Fermez toutes les portes et fenêtres.</li> <li>Nettoyez ou remplacez les filtres.</li> <li>Dégagez toute obstruction dans les ouvertures d'entrée et de sortie d'air.</li> </ul>
L'appareil fait du bruit lorsqu'il fonctionne.	<ul style="list-style-type: none"> <li>Vérifiez que l'appareil est installé sans inclinaison.</li> <li>Fermez correctement le panneau avant.</li> </ul>
La télécommande ne fonctionne pas. (L'affichage est atténué ou le signal émis est faible.)	<ul style="list-style-type: none"> <li>Insérez les piles correctement.</li> <li>Remplacez les piles faibles.</li> </ul>
L'appareil ne fonctionne pas.	<ul style="list-style-type: none"> <li>Vérifiez si le coupe-circuit est déclenché.</li> <li>Vérifiez si des minuteries ont été réglées.</li> </ul>
L'appareil ne reçoit pas le signal de la télécommande.	<ul style="list-style-type: none"> <li>Vérifiez que le récepteur n'est pas obstrué.</li> <li>Certaines lampes fluorescentes peuvent interférer avec le signal de l'émetteur. Veuillez contacter le revendeur autorisé.</li> </ul>

## PIECES NON SUSCEPTIBLES D'ETRE REPARÉES PAR VOS SOINS

COUPEZ LA SOURCE D'ALIMENTATION ET DÉBRANCHEZ et ensuite veuillez consulter un revendeur agréé dans les conditions suivantes:

- Bruits anormaux pendant la mise en service.
- Pénétration d'eau ou de corps étrangers à l'intérieur de la télécommande.
- Fuite d'eau de l'unité intérieure.
- Désactivation fréquente du disjoncteur.
- Le cordon d'alimentation est inhabituellement chaud.
- Les interrupteurs ou les boutons ne fonctionnent pas correctement.
- Le voyant de la minuterie clignote et l'appareil ne peut pas fonctionner.

## L'unité s'arrête et le voyant du MINUTEUR clignote.

Utilisez la télécommande pour récupérer le code d'erreur.

- Appuyez sur cette touche pendant au moins 5 secondes.
- Appuyez sur cette touche jusqu'à ce que vous entendiez un bip, puis notez le code d'erreur.
- Appuyez à nouveau sur cette touche lorsque la vérification est terminée.
- Débranchez l'unité et indiquez le code d'erreur au revendeur autorisé.

# Guía rápida

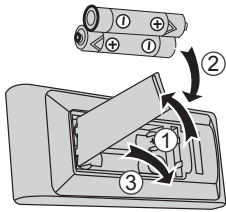

## Colocación de las pilas

- ① Retire la tapa de las pilas
- ② Inserte pilas AAA o R03 (puede ser usado ~ 1 año)
- ③ Cierre la tapa

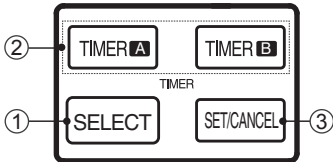

## Ajuste del TEMPORIZADOR

- ① Pulse SELECT
- ② Ajuste el tiempo
- ③ Confirme

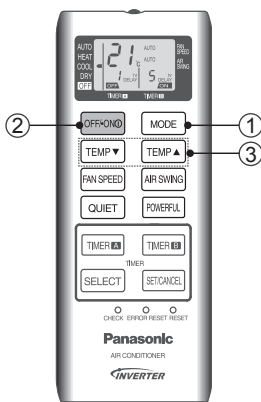

## Funcionamiento básico

- ① Seleccione el modo deseado  
 AUTO → HEAT → COOL → DRY  
 ↑

- ② Inicie/detenga el funcionamiento



- Tenga en cuenta que la indicación OFF es el siguiente:

Para empezar: OFF ◀  
 Para detener: OFF ▶

- ③ Seleccione la temperatura deseada

- Rango de selección: 16 °C ~ 30 °C.
- El manejo de la unidad dentro de la temperatura recomendada puede ahorrar energía.  
 CALOR: 20 °C ~ 24 °C.  
 FRÍO : 26 °C ~ 28 °C.  
 SECO : 1 °C ~ 2 °C más baja que la temperatura de la habitación.

- Utilizar el comando remoto a distancia dentro de 8m del receptor de control remoto de la unidad interior.

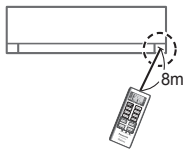

Las ilustraciones de este manual tienen únicamente un fin explicativo y pueden no coincidir exactamente con las del equipo suministrado. Están sujetas a cambios sin previo aviso con el fin de mejorar el producto.

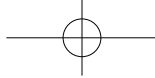

## Contenido

Precauciones de seguridad .....	20-21
Cómo utilizar .....	22-23
Instrucciones de limpieza .....	24
Localización de averías .....	25
Especificación de Producto .....	50
Información .....	55

### Accesorios

- Control remoto
- Pilas AAA o R03 × 2



# Precauciones de seguridad

Para evitar lesiones personales, daños a otras personas o daños materiales, cumpla con lo siguiente:  
El uso incorrecto por no seguir las instrucciones pueden causar daños o averías; su gravedad se clasifica con las de la siguiente manera:

 **ADVERTENCIA** Esta indicación advierte del posible peligro de muerte o de daños graves.

 **PRECAUCIÓN** Esta indicación advierte de los posibles daños o desperfectos materiales.

Las instrucciones que deben seguirse están clasificadas mediante los siguientes símbolos:

 Este símbolo denota una acción que está PROHIBIDA.

 Estos símbolos denotan acciones OBLIGATORIA.

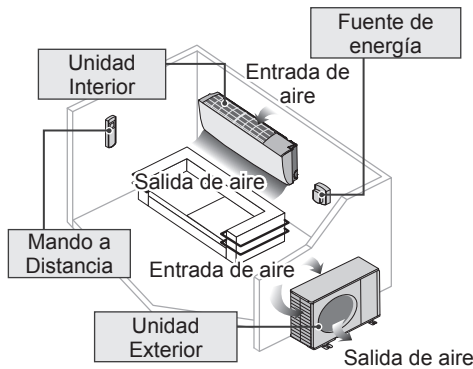

## ADVERTENCIA

### Unidad interior y unidad exterior

 Este aparato no debe ser utilizado por personas (incluyendo niños) con discapacidades mentales, sensoriales o físicas, o falta de experiencia y conocimiento, a menos que hayan recibido formación o supervisión en relación al uso del aparato por una persona responsable por su seguridad. Los niños deberían estar supervisados para asegurar que no juegan con el aparato.

Consulte a un distribuidor autorizado o especialista para limpiar las piezas internas, reparar, instalar, retirar y reinstalar la unidad. Una instalación y uso incorrectos provocarán fugas, descargas eléctricas o incendios.

Confirme con el distribuidor autorizado o especialista en el uso de cualquier tipo de refrigerante especificado.

Utilizando el tipo de refrigerante que no sea el especificado puede causar daños en el producto, explosión y lesiones, etc.

 No instale la unidad en ambientes potencialmente explosivos o inflamables. En caso contrario, podría provocar accidentes de incendios.

No introduzca los dedos u otros objetos en la unidad exterior o interior del aire acondicionado, ya que las partes rotatorias podrían provocarle lesiones.



No toque la unidad exterior durante un relámpago, ya que podría causar una descarga eléctrica.

No se exponga directamente al aire frío por un periodo prolongado de tiempo, así evitará el enfriamiento excesivo.

No se siente o pare sobre la unidad, se podría caer accidentalmente.



### Mando a distancia

 No permita que bebés y niños pequeños jueguen con el mando a distancia para evitar que ingieran accidentalmente las pilas.

### Fuente de energía

 No utilice un cable modificado, cable de empalme, cable de extensión o el cable no especificado para evitar el sobrecalentamiento y fuego.



Para prevenir sobrecalentamiento, incendios o descargas eléctricas:

- No comparta un único enchufe con otros equipos.
- No utilice el equipo con las manos húmedas.
- No incline el cable del suministro eléctrico.
- No encienda ni detenga el equipo enchufando o desenchufando el cable de alimentación.



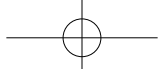

## ADVERTENCIA

### Fuente de energía



Si el cable de alimentación está dañado, debe ser reemplazado por el fabricante del agente de servicio o por personal cualificado, con el fin de evitar un peligro.

Se recomienda altamente instalarlo con un disyuntor de fuga a tierra (ELCB) o un dispositivo residual actual (RCD) para evitar descargas eléctricas o incendios.

Para prevenir sobrecalentamiento, incendios o descargas eléctricas:

- Enchufe el cable de alimentación adecuadamente.
- El polvo del enchufe debe limpiarse continuamente con un paño seco.

Absténgase de utilizar el producto en caso de que presente alguna anomalía/fallo, y desconecte el enchufe o apague el interruptor de alimentación y el disyuntor.

(Riesgo de humo/incendio/descarga eléctrica)

Ejemplos de anomalías/fallas

- Activación frecuente del ELCB.
- Olor a quemado.
- Ruido o vibración anormales de la unidad.
- Filtración de agua desde la unidad interior.
- Calentamiento inusual del cable o enchufe.
- La velocidad del ventilador no puede controlarse.
- La unidad deja de funcionar inmediatamente, incluso si se enciende para su operación.
- El ventilador no se detiene, incluso si la operación se suspende.

Contacte inmediatamente con su distribuidor local para el mantenimiento/repelación.

Sólo personal autorizado/cualificado debe reemplazar o instalar los enchufes. Los cables de la red de distribución eléctrica tienen colores, de acuerdo al siguiente código.

Terminales	cables	colores (Estándar IEC)
<b>L</b>	Rojo	masa marrón
<b>N</b>	Negro	neutro azul
<b>E</b>	Verde/Amarillo	tierra verde-amarillo

Los colores de los cables pueden variar de acuerdo al código estándar de cada país.



Este equipo debe estar conectado a tierra para evitar descargas eléctricas o incendios.



Evitar descargas eléctricas desconectando la fuente de alimentación:



- Antes de limpiarlo o repararlo.
- Cuando extendida de no uso, o
- Durante la fuerte anormal actividad eléctrica.



## PRECAUCIÓN

### Unidad interior y unidad exterior



No lave la unidad interior con el agua, bencina, disolvente o limpiador en polvo para evitar la corrosión o daños en la unidad.



No lo utilice para la conservación de equipos, alimentos, animales, plantas, material gráfico u otros objetos. Esto puede provocar el deterioro de la calidad, etc.

No utilice ningún equipo combustible frente al flujo de aire para evitar la propagación del fuego.

No exponga directamente a las plantas o mascotas a las corrientes de aire, para evitar daños, etc.

No tocar las partes de aluminio angulosas, pueden causar daños.



No encienda la unidad cuando encere el suelo. Después de encerrar, airee la habitación correctamente antes de usar la unidad.

No instale la unidad en áreas aceitosas y llenas de humo, para prevenir que la unidad se dañe.

No desmonte la unidad para limpiarla, así evitará daños.

No se suba a un banquillo inestable al limpiar el aparato para evitar lesiones.

No coloque un jarrón o recipiente de agua sobre la unidad. El agua puede entrar en la unidad y degradar el aislamiento. Esto podría causar una descarga eléctrica.

No abra la puerta o ventana por mucho tiempo en el modo de operación FRÍO / SECO.



Evitar las fugas de agua, asegurando que la tubería de drenaje es:  
- Conectado correctamente,  
- Mantenerse libre de canalones y recipientes, o  
- No sumergido en agua

Después de un largo periodo de uso o el uso con cualquier equipo combustible, airear la habitación con regularidad.

Después de un largo periodo de uso, asegúrese de que el bastidor de la instalación no se deteriore para evitar que la unidad se caiga.

### Mando a distancia



No utilice pilas recargables (Ni-Cd). Podría dañar el control remoto.



Para prevenir una función inadecuada o daño en el control remoto:

- Extraiga las pilas si el equipo no va a ser utilizado durante un periodo prolongado de tiempo.
- Es necesario insertar las pilas según la polaridad indicada.

### Fuente de energía



No desconectar el enchufe tirando el cable para evitar descargas eléctricas.

# Cómo utilizar

OFF/ON

**Para encender o apagar la unidad**

TEMP ▼

TEMP ▲

**Para ajustar la temperatura**

FAN SPEED

**Para seleccionar la velocidad del ventilador (5 opciones)**

(Pantalla del control remoto)



- Para AUTO (automático), la velocidad de ventilador de interior es ajustada automáticamente según el modo de operación.

QUIET

**Para disfrutar de un ambiente silencioso**

- Esta configuración proporciona un ambiente silencioso reduciendo el ruido de la salida de aire.



Receptor del control remoto y el indicador

POWER	(VERDE)
TIMER	(NARANJA)
QUIET	(VERDE)
POWERFUL	(ROJO)

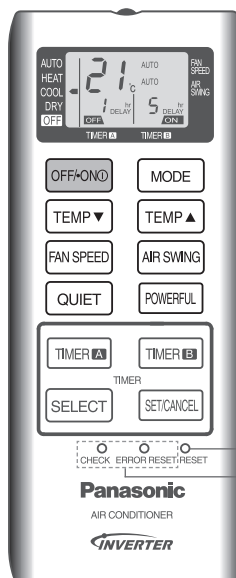

Pulse para restaurar el control remoto a la configuración predeterminada.

No utilizado en funciones normales

## Para ajustar la dirección del flujo de aire horizontal

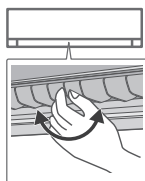

• Lávelo con cuidado y séquelo.

## Botón OFF/ON auto



Se utiliza cuando el control remoto está fuera de lugar o se produce un mal funcionamiento. Levante el panel frontal:

- Para utilizar en modo AUTO, presione el botón una vez.
- Para utilizar en el modo FRÍO, presione y pulsa el botón hasta que un pitido se oye, luego suelte.
- Para utilizar en el modo CALOR, presione y pulsa el botón hasta el un pitido se oye, luego suelte, y pulse nuevamente hasta 2 tonos, luego suelte.
- Pulse el botón de nuevo para apagar.

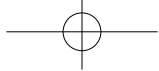

## MODE Seleccionar modo de operación

### Modo AUTOMÁTICO - Para su comodidad

- Durante la selección del modo de funcionamiento el indicador de encendido parpadea.
- La unidad selecciona el modo de operación de acuerdo con la temperatura interna y con la temperatura del control remoto.

### Modo CALOR - Para disfrutar de aire caliente

- En modo calor, puede pasar un rato hasta que el equipo se caliente.

### Modo FRÍO - Para disfrutar de aire frío

- Para reducir el consumo de energía durante el modo FRÍO, utilice cortinas para proteger de la luz solar y el calor de fuera.

### Modo DESHUMIDIFICACIÓN - Para deshumidificar el ambiente

- La unidad funciona en la velocidad de ventilador bajo para proporcionar una agradable refrigeración.

## AIR SWING

### Para ajustar la dirección del flujo de aire vertical (5 opciones)

(Pantalla del control remoto)



- Mantiene la habitación ventilada.
- En el modo FRÍO, si el AUTO está ajustado, la persiana se balancea hacia arriba/abajo automáticamente.
- En el modo CALOR, si AUTOMÁTICO está activado, la rejilla horizontal se fija a una posición determinada.
- No ajuste la persiana con la mano.

## POWERFUL

### Para alcanzar la temperatura

- Esta configuración permite que la temperatura deseada se alcance rápidamente.

NOTA: Los modos POWERFUL y QUIET no pueden activarse simultáneamente.

## Para establecer el temporizador

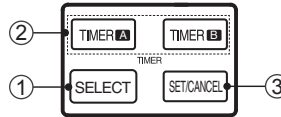

- Para encender la unidad a una hora predeterminada. Ajustar el temporizador mientras la unidad está apagada.

- Para apagar la unidad a una hora predeterminada. Establezca el temporizador mientras la unidad está encendida.

① Presione una vez para seleccionar el temporizador.

② Presione **TIMER A** / **TIMER B** varias veces para ajustar la hora deseada.

③ Pulse una vez para confirmar.

- Para encender y apagar la unidad en el momento predeterminado. Ajustar los temporizadores cuando la unidad está apagada.

- Para apagar y encender la unidad en el momento predeterminado. Ajustar los temporizadores mientras la unidad está encendida.

① Presione dos veces para seleccionar los temporizadores.

② Presione **TIMER A** / **TIMER B** varias veces para ajustar su tiempo deseado.

③ Pulse una vez para confirmar.

- Pulse el botón **SET/CANCEL** otra vez para cancelar el funcionamiento temporizado.

- El temporizador también se cancela cuando se pulsa el botón **OFF/ON/O**.

- El indicador del temporizador de la unidad interior se encenderá durante el funcionamiento del temporizador.

- Cuando el temporizador de encendido esté configurado, la unidad podría comenzar a funcionar antes de la hora configurada para lograr la temperatura deseada a tiempo.

- Si el temporizador se cancela manualmente o debido a un corte de energía, puede restablecerlo repitiendo los pasos descritos arriba (una vez se restablezca la alimentación).

## Condiciones de funcionamiento

Utilice este aparato de aire acondicionado dentro del siguiente intervalo de temperaturas.

Temperatura (°C)		Interior		Exterior	
		*DBT	*WBT	*DBT	*WBT
MODO FRÍO	Máximo	32	23	43	26
	Mínimo	16	11	-10	11
MODO CALOR	Máximo	30	-	24	18
	Mínimo	16	-	-15	-6

DBT: Temperatura en seco

WBT: Temperatura en húmedo

AVISO: • Este modelo no está preparado para un funcionamiento continuo durante 24 horas en modo de calefacción bajo -15 °C. Cuando la temperatura exterior sea inferior a -15 °C y utilice este modelo fuera de las condiciones de arriba, la unidad exterior se podría congelar y parar el funcionamiento para control de protección.



# Instrucciones de limpieza

**Para garantizar un rendimiento óptimo de la unidad, la limpieza tiene que ser llevada a cabo a intervalos regulares.**

- Apague la fuente de alimentación y desenchufe la máquina antes de limpiarla.
- No toque las partes angulosas de aluminio pueden causar heridas.
- No utilice benceno, disolvente o limpiador en polvo.
- Utilice sólo jabones ( $\approx$  pH7) o detergentes domésticos neutros.
- No utilice agua con una temperatura superior a 40 °C.

## Unidad interior

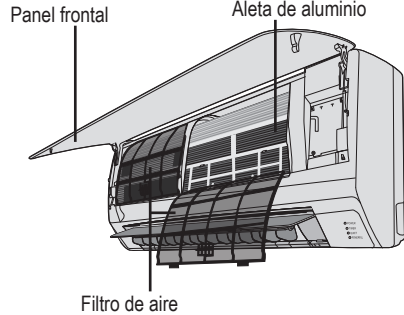

### Unidad interior

Limpie la unidad suavemente con un paño suave y seco.



### Filtro de aire

Limpie los filtros regularmente

- Lave/enjuague los filtros con agua, con cuidado para evitar dañar la superficie del mismo.
- Secar minuciosamente los filtros a la sombra, lejos del fuego o la luz solar directa.
- Reemplace los filtros dañados.



### Panel frontal

Lávelo con cuidado y séquelo.

#### Retire el panel frontal

② Extraer

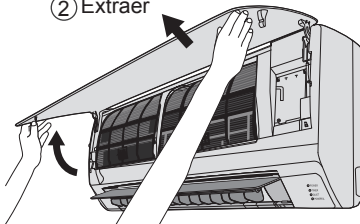

① Elevar

#### Quite el filtro de aire

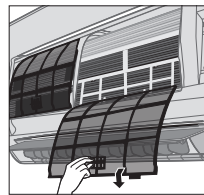

#### Coloque el filtro de aire

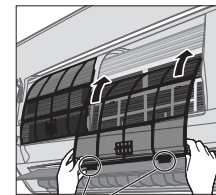

Inserte en la unidad

#### Cierre de forma segura

③ Presione ambos extremos del panel frontal

① Insertar en ambos los lados

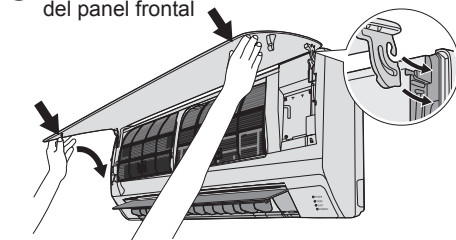

② Cerrar

#### Para inspección estacional después de un largo periodo en desuso

- Verifique las pilas del mando a distancia.
- Compruebe que las tomas de entrada y salida de las rejillas de ventilación no estén obstruidas.
- Use el botón Auto OFF/ON (apagado/encendido automático) para seleccionar el funcionamiento de Refrigeración/Calefacción. Después de 15 minutos de funcionamiento, es normal tener la siguiente diferencia de temperatura entre la ventilación del aire que ingresa y el aire que sale:

Enfriamiento:  $\geq 8$  °C      Calentamiento:  $\geq 14$  °C

#### Si no se va a utilizar la unidad durante un periodo prolongado de tiempo

- Apague la fuente de alimentación y desenchufe.
- Extraiga las pilas del mando a distancia.



# Localización de averías

Las siguientes señales no indican un mal funcionamiento.

Señal	Causa
Sale neblina de la unidad interior.	<ul style="list-style-type: none"> <li>Efecto de condensación producido durante el proceso de enfriamiento.</li> </ul>
Se escucha un sonido similar a agua fluyendo durante el funcionamiento.	<ul style="list-style-type: none"> <li>Flujo del refrigerante en el interior de la unidad.</li> </ul>
Hay un olor extraño en la habitación.	<ul style="list-style-type: none"> <li>Puede ocurrir debido al olor a humedad producido por las paredes, las alfombras, los muebles o las telas de la habitación.</li> <li>Con esto se eliminan los malos olores del ambiente.</li> </ul>
El ventilador interior se para de vez en cuando con la velocidad del ventilador automática.	<ul style="list-style-type: none"> <li>El retraso responde a un dispositivo de protección del compresor de la unidad.</li> </ul>
La operación tarda unos minutos después de volver a arrancar.	<ul style="list-style-type: none"> <li>Se produce condensación o evaporación en los tubos.</li> </ul>
La unidad exterior emite agua o vapor.	<ul style="list-style-type: none"> <li>Es la función de reanudación automática del equipo. El funcionamiento se restablecerá en el mismo modo y dirección de aire en que se encontraba anteriormente cuando se restablece la corriente ya que el funcionamiento no se ha detenido mediante el mando a distancia.</li> </ul>
El equipo funciona automáticamente cuando la alimentación se restablece tras un fallo de corriente.	<ul style="list-style-type: none"> <li>Para evitar un efecto de enfriamiento indeseado.</li> </ul>
El ventilador interior se para de vez en cuando durante la función de calentamiento.	<ul style="list-style-type: none"> <li>Se trata de un paso preliminar para preparar el funcionamiento cuando se ha ajustado el temporizador de encendido.</li> </ul>
El indicador de encendido parpadea antes de encender la unidad.	<ul style="list-style-type: none"> <li>Los cambios de temperatura causan la expansión/contracción de la unidad.</li> </ul>
Sonido seco (de chasquido) durante el funcionamiento.	

Instrucciones de limpieza / Localización de averías

Compruebe lo siguiente antes de llamar a un técnico

Señal	Compruebe
El funcionamiento en modo FRÍO / CALOR no está funcionando de manera eficiente.	<ul style="list-style-type: none"> <li>Programe la temperatura correctamente.</li> <li>Cierre todas las puertas y ventanas.</li> <li>Limpie o sustituya los filtros.</li> <li>Limpie cualquier obstrucción en la entrada y salida de aire.</li> </ul>
Funcionamiento ruidoso.	<ul style="list-style-type: none"> <li>Compruebe si la unidad ha sido instalada en una inclinación.</li> <li>Cierre el panel delantero correctamente.</li> </ul>
El mando a distancia no funciona. (La pantalla está oscura o la señal de transmisión es débil.)	<ul style="list-style-type: none"> <li>Inserte las baterías correctamente.</li> <li>Reemplace las baterías débiles.</li> </ul>
La unidad no funciona.	<ul style="list-style-type: none"> <li>Compruebe si el disyuntor está activado.</li> <li>Compruebe si los temporizadores han sido programados.</li> </ul>
La unidad no recibe la señal del mando a distancia.	<ul style="list-style-type: none"> <li>Asegúrese de que el receptor no esté obstruido.</li> <li>Ciertas luces fluorescentes puede interferir con el transmisor de señal. Consulte con un distribuidor autorizado.</li> </ul>

Español

## No utilice la unidad si

APAGUE LA ALIMENTACIÓN Y DESENCHUFE, por favor consulte con el distribuidor autorizado las siguientes condiciones:

- Si escucha ruidos extraños durante el funcionamiento.
- Si entra agua o elementos extraños en el mando a distancia.
- Si hay escapes de agua de la unidad interior.
- Si el interruptor del circuito salta frecuentemente.
- El cable de alimentación está demasiado caliente.
- Los interruptores o los botones no funcionan correctamente.
- El indicador de temporizado parpadea y el equipo no funciona.

## La unidad se detiene y parpadea el indicador del temporizador.

Use el control remoto para recuperar el código de error.

1 Pulse durante 5 segundos.

2 Pulse hasta escuchar un pitido y, después, apunte el código del error.

3 Pulse para abandonar la comprobación.

4 Apague la unidad e informe el código de error al distribuidor autorizado.

# Guida rapida

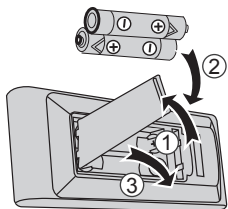

## Inserimento delle batterie

- ① Rimuovere il coperchio batteria
- ② Inserire batterie AAA o R03 (può essere utilizzato per circa 1 anno)
- ③ Chiudere il coperchio

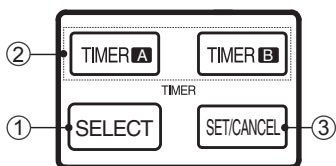

## Impostazioni TIMER

- ① Premere SELEZIONA
- ② Impostare l'orario
- ③ Confermare

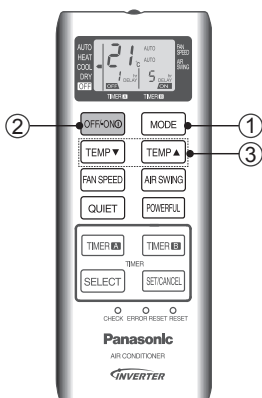

## Operazione di base

- ① Selezionare la modalità desiderata

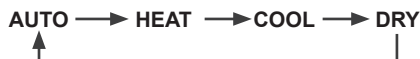

- ② Avviare/arrestare l'apparecchio



• L'indicazione OFF è la seguente:

Per iniziare : OFF

Per fermare : OFF

- ③ Selezionare la temperatura desiderata

- Intervallo di selezione: 16°C ~ 30°C.
- Avviare l'unità alle temperature consigliate può consentire un risparmio energetico.  
RISCALDAMENTO : 20°C ~ 24°C .  
RAFFREDDAMENTO : 26°C ~ 28°C .  
SECCO : 1°C ~ 2°C in meno rispetto alla temperatura ambiente.

• Utilizzare il telecomando a una distanza massima di 8m dal ricevitore del telecomando dell'unità interna.

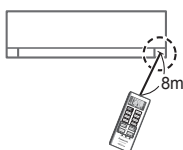

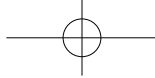

## Indice

Precauzioni per la sicurezza.....	<b>28-29</b>
Come utilizzarlo.....	<b>30-31</b>
Istruzioni per la pulizia.....	<b>32</b>
Soluzione dei problemi.....	<b>33</b>
Specifiche del prodotto.....	<b>50</b>
Informazioni.....	<b>55</b>

### Accessori

- Telecomando
- 2 batterie AAA o R03

# Precauzioni per la sicurezza

Per evitare lesioni personali, lesioni ad altri o danni materiali, attenersi a quanto segue:  
 Il funzionamento non corretto a causa di un guasto seguendo le istruzioni qui sotto potrebbe causare lesioni o danni, la cui gravità è classificata come segue:

	<b>AVVERTENZE</b>	Questo simbolo indica un pericolo di morte o lesioni gravi.
--	-------------------	---

	<b>ATTENZIONE</b>	Questo simbolo indica un rischio di lesioni o danni materiali.
--	-------------------	--

Le istruzioni sono classificate in varie tipologie, contrassegnate dai seguenti simboli:

	Questo simbolo indica un'azione <b>PROIBITA</b> .
--	---

	Questi simboli indicano le azioni <b>OBBLIGATORIE</b> .
--	---

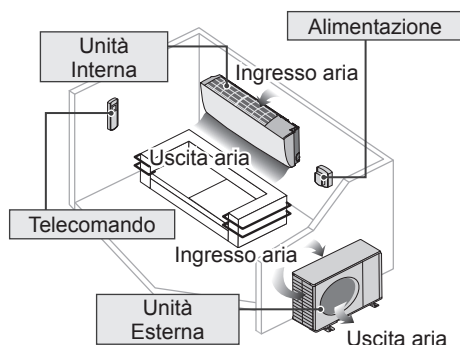

## AVVERTENZE

### Unità interna e unità esterna



L'uso di questo apparecchio non è destinato a persone con capacità fisiche, sensoriali o mentali ridotte (compresi i bambini), o mancanza di esperienza o competenza, a meno che non siano supervisionate o istruite sull'uso dell'apparecchio da una persona responsabile della loro sicurezza. Fare attenzione che i bambini non giochino con l'apparecchio.

Consultare un rivenditore autorizzato o uno specialista per pulire le parti interne, per riparare, installare, rimuovere e reinstallare l'unità. L'installazione e la gestione non corrette provocano perdite, shock elettrico o incendio.

Confermare con un concessionario autorizzato o specialista l'utilizzo di qualsiasi tipo di refrigerante. Utilizzando il tipo del refrigerante diverso da quello specificato potrebbe causare danni al prodotto, scoppi o lesioni ecc.



Non installare l'unità in un ambiente con atmosfera potenzialmente esplosiva o infiammabile. La mancata esecuzione di ciò può causare un incendio.

Non inserire dita o altri oggetti nell'unità interna o esterna del condizionatore d'aria, i componenti rotanti possono provocare lesioni.



Non toccare l'unità esterna durante temporali con fulmini, ciò potrebbe provocare una scossa elettrica.

Non esporsi direttamente all'aria fredda per un lungo periodo di tempo, per evitare un raffreddamento eccessivo.

Non sedersi o camminare sull'unità, si può cadere in modo accidentale.



### Telecomando



Non permettere a bambini piccoli di giocare con il telecomando, al fine di evitare che ingeriscano accidentalmente le batterie.

### Alimentation



Per evitare il surriscaldamento e incendio, non utilizzare un cavo modificato, un connettore, una prolunga o un cavo non specificato.



Per evitare surriscaldamento, incendio o shock elettrico:

- Non usare la stessa presa di alimentazione per più apparecchi.
- Non usare con le mani bagnate.
- Non piegare troppo il cavo di alimentazione.
- Non azionare o arrestare l'unità inserendo o estraendo la spina di alimentazione.



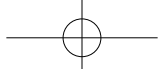

## AVVERTENZE

### Alimentazione



Se il cavo di alimentazione è stato danneggiato, rivolgersi al produttore, a un centro di assistenza autorizzato o ad un tecnico qualificato onde evitare rischi.

Per evitare scosse o incendio, si raccomanda fortemente l'installazione di un salvavita contro le perdite a terra (ELCB) o un interruttore differenziale (RCD).

Per evitare surriscaldamento, incendi o shock elettrico:

- Inserire correttamente il cavo di alimentazione.
- La polvere sulla spina elettrica deve essere rimossa periodicamente con un panno asciutto.

Interrompere l'uso del prodotto qualora si verificano anomalie/guasti e scollegare la spina elettrica o disattivare l'alimentazione e l'interruttore.

(Rischio di fumo/incendio/shock elettrico) Esempi di anomalia/guasto

- L'ELCB scatta di frequente.
- Si osserva odore di bruciato.
- Si osservano rumori anomali o vibrazione dell'unità.
- Ci sono perdite di acqua dall'unità interna.
- Il cavo di alimentazione o la spina diventano insolitamente caldi.
- Impossibile controllare la velocità della ventola.
- L'unità smette di funzionare immediatamente anche se è accesa.
- La ventola non si arresta anche se il funzionamento è interrotto.

Contattare il rivenditore locale immediatamente per manutenzione/riparazione.

La sostituzione o la installazione delle spine elettriche deve essere eseguita solo da personale autorizzato/qualificato. I cavi della rete elettrica sono colorati secondo il codice che segue:

Terminali	cavi	colori (Standard IEC)
L	Rosso	fase marrone
N	Nero	neutrale blu
E	Verde/giallo	terra verde-giallo

Il colore dei cavi può variare a seconda dello standard dei codici di una nazione.



Il presente apparecchio deve avere la messa a terra per prevenire scosse o incendio.



Evitare scosse togliendo la corrente e staccando la spina nei seguenti casi:

- Prima di pulire o eseguire la manutenzione.
- Inutilizzo prolungato dell'apparecchio o
- Durante attività anomala delle spie luminose.



## ATTENZIONE

### Unità interna e unità esterna



Non lavare l'unità interna con acqua, benzene, diluenti o polveri detergenti aggressive al fine di evitare danni o corrosione all'unità.



Non usare per conservare apparecchi di precisione, alimenti, animali, piante, opere d'arte o altri oggetti. Questo potrebbe provocare un deterioramento della qualità, ecc.

Non utilizzare apparecchiatura infiammabile di fronte all'uscita del flusso dell'aria per evitare la propagazione delle fiamme.

Non esporre piante o animali direttamente al flusso dell'aria per evitare lesioni, ecc.

Non toccare l'aletta in alluminio affilata, parti affilate possono causare delle lesioni.



Non accendere l'unità interna quando si passa la cera sul pavimento. Dopo tale operazione, aerare accuratamente la stanza prima di mettere in funzione l'unità.

Per evitare danni all'unità, non installare l'unità in aree piene di olio e fumo.

Per evitare lesioni, non smontare l'unità per scopi di pulizia.

Non appoggiarsi ad un piano instabile quando si pulisce l'unità per evitare lesioni.

Non posizionare vasi o contenitori di acqua sull'unità. L'acqua potrebbe penetrare nell'unità e rovinare l'isolamento causando una scossa elettrica.

Non aprire la finestra o la porta per un periodo di tempo prolungato durante il funzionamento in modalità FREDDO/SECCO.



Al fine di evitare la perdita d'acqua, assicurarsi che il tubo di drenaggio sia:

- Collegato in modo corretto,
- Libero da canali di scolo o contenitori oppure
- Non immerso in acqua

Dopo un lungo periodo di utilizzo o di utilizzo con apparecchiatura infiammabile, aerare regolarmente la stanza.

Dopo un lungo periodo di utilizzo, assicurarsi che il braccio di installazione non si logori per evitare la caduta dell'unità.

### Telecomando



Non utilizzare batterie ricaricabili (Ni-Cd). Può danneggiare il telecomando.



Per evitare malfunzionamenti o danni al telecomando:

- Rimuovere le batterie se l'unità non sarà usata per molto tempo.
- Bisogna inserire batterie nuove dello stesso tipo, seguendo la polarità prevista.

### Alimentazione



Non tirare il cavo per staccare la spina al fine di prevenire uno shock elettrico.

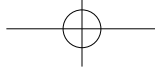

# Come utilizzarlo



**Per accendere o spegnere l'unità**



**Per impostare la temperatura**



**Per selezionare la velocità del ventilatore (5 opzioni)**

(Display telecomando)



- Per la modalità automatica, la velocità della ventola interna viene regolata automaticamente in base alla modalità operativa.



**Per godere di un ambiente silenzioso**

- Questa impostazione garantisce un ambiente silenzioso riducendo il rumore del flusso dell'aria.



Ricevitore e indicatore telecomando

POWER	(VERDE)
TIMER	(ARANCIONE)
QUIET	(VERDE)
POWERFUL	(ROSSO)

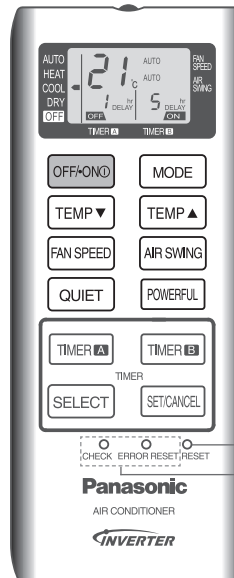

Premere per ripristinare il telecomando alle impostazioni di default.

Da non utilizzare in operazioni normali.

## Per regolare orizzontalmente la direzione del flusso d'aria

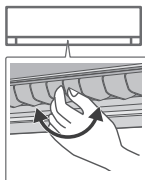

• Regolabili a mano.

## Tasto auto OFF/ON

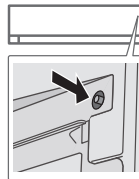

Da utilizzare quando il telecomando è fuori posto o presenta anomalie. Sollevare il pannello anteriore:

- Per utilizzarlo in modalità AUTO, premere il tasto una volta.
- Per utilizzarlo in modalità RAFFREDDAMENTO, premere e tenere premuto fino a quando non si sente 1 bip, quindi rilasciare.
- Per utilizzarlo in modalità RISCALDAMENTO, premere e tenere premuto fino a quando non si sente 1 bip, quindi rilasciare. Premere nuovamente fino a quando si sentono 2 bip, quindi rilasciare.
- Premere di nuovo il tasto per spegnere.

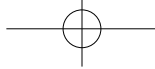

## MODE Per impostare la temperatura

### Modalità AUTO - Per la propria comodità

- Durante la selezione l'indicatore di alimentazione lampeggia.
- L'unità seleziona la modalità di funzionamento secondo la temperatura interna di ingresso e la temperatura del telecomando.

### Modalità RISCALDAMENTO - Per godere dell'aria calda

- In modalità riscaldamento, ci può volere un pò di tempo perché l'unità si riscaldi.

### Modalità RAFFREDDAMENTO - Per godere dell'aria fresca

- Per ridurre il consumo di energia durante la modalità di RAFFREDDAMENTO, utilizzare le tende per riflettere la luce del sole e il calore esterno.

### Modalità DEUMIDIFICAZIONE - Per deumidificare l'ambiente

- La ventola dell'unità opera a bassa velocità, al fine di eseguire l'operazione di raffreddamento in maniera molto delicata.

## AIR SWING Per regolare la direzione verticale del flusso d'aria (5 opzioni)

(Display telecomando)

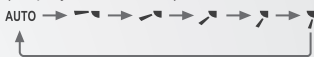

- Mantiene la stanza ventilata.
- In modalità RAFFREDDAMENTO, la griglia per lo spostamento dell'aria si alzerà e abbasserà automaticamente.
- In modalità HEAT (CALDO), se è impostata l'opzione AUTO, la griglia orizzontale per lo spostamento dell'aria si porta a una posizione predeterminata.
- Non regolare manualmente la griglia per lo spostamento dell'aria.

## POWERFUL Per raggiungere rapidamente la temperatura

- Questa impostazione consente di raggiungere rapidamente la temperatura impostata desiderata.

NOTA: Il funzionamento POTENTE e quello SILENZIOSO non possono essere attivati contemporaneamente.

## Per impostare il timer

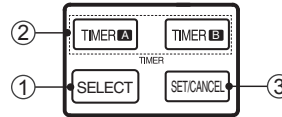

- Per accendere l'unità in un dato momento. Impostare il timer quando l'unità è spenta.

- Per spegnere l'unità in un dato momento. Impostare il timer quando l'unità è accesa.

① Premere una volta per selezionare il timer.

② Premere **TIMER A** / **TIMER B** ripetutamente per impostare l'orario desiderato.

③ Premere una volta per confermare.

- Per accendere e spegnere l'unità in un dato momento. Impostare i timer quando l'unità è spenta.

- Per spegnere e accendere l'unità in un dato momento. Impostare i timer quando l'unità è accesa.

① Premere due volte per selezionare i timer

② Premere **TIMER A** / **TIMER B** ripetutamente per impostare l'orario desiderato.

③ Premere una volta per confermare.

- Premere di nuovo il tasto **SET/CANCEL** per annullare il timer di accensione.

- Anche il timer verrà annullato quando si preme il tasto **OFF/ON/OFF**.

- L'indicatore del timer dell'unità interna si alzerà durante il funzionamento del timer.

- Quando si imposta il timer di accensione, l'unità può avviarsi prima del tempo reale impostato per raggiungere in tempo la temperatura desiderata.

- Se il timer viene annullato manualmente per un'assenza di elettricità, è possibile ripristinare il timer nuovamente ripetendo le fasi suddette (quando l'elettricità è nuovamente presente).

Come utilizzarlo

Italiano

## Condizioni operative

Questo condizionatore può essere utilizzato con temperature rientranti nel seguente intervallo.

Temperatura (°C)		Interna		Esterna	
		*DBT	*WBT	*DBT	*WBT
RAFFREDDAMENTO	Massimo	32	23	43	26
	Minimo	16	11	-10	11
RISCALDAMENTO	Massimo	30	-	24	18
	Minimo	16	-	-15	-6

DBT: Temperatura con bulbo secco  
WBT: Temperatura con bulbo bagnato

AVVISO: • Questo modello non è adatto al funzionamento ininterrotto per 24 ore in modalità di riscaldamento in temperature inferiori a -15°C. Quando la temperatura esterna è inferiore a -15°C e si utilizza questo modello al di fuori delle condizioni di cui sopra, l'unità esterna potrebbe bloccarsi e arrestare il funzionamento rispondendo ad un comando di sicurezza.



# Istruzioni per la pulizia

**Per assicurare prestazioni ottimali dell'unità, la pulitura deve essere eseguita a intervalli regolari.**

- Prima della pulitura, spegnere l'alimentazione e scollegarla.
- Non toccare l'aletta in alluminio, le parti affiliate potrebbero causare lesioni.
- Non lavare l'apparecchio con benzene, solventi o polveri abrasive.
- Impiegare esclusivamente saponi o detersivi neutri per la casa ( $\approx$  pH7).
- Non usare acqua ad una temperatura superiore a 40°C.

## Unità interna

Pannello anteriore

Aletta in alluminio

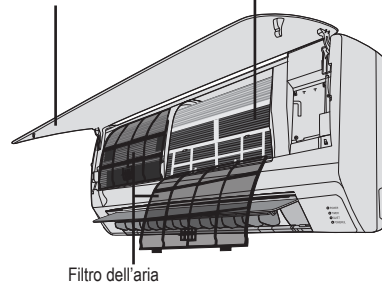

## Unità interna

Asciugare l'apparecchio con un panno morbido e asciutto.



## Filtro dell'aria

Pulire i filtri regolarmente

- Lavare/risciacquare delicatamente i filtri con acqua al fine di evitare danni alla loro superficie.
- Asciugare accuratamente i filtri all'ombra, lontano da fiamme o dalla luce diretta del sole.
- Sostituire i filtri danneggiati.



## Pannello anteriore

Lavare delicatamente ed asciugare.

### Rimuovere il pannello anteriore

② Estrarre

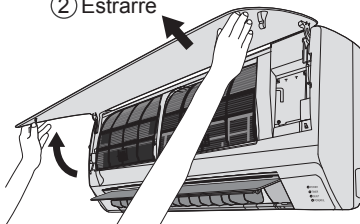

① Sollevare

### Chiudere bene

③ Premere su entrambe le estremità del pannello anteriore

① Inserire in entrambi i lati

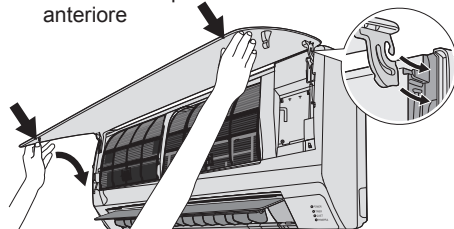

② Chiudere

### Rimuovere il filtro dell'aria Collegare il filtro dell'aria

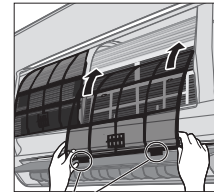
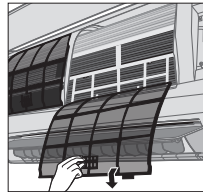

Inserire nell'unità

### Per l'ispezione stagionale dopo un periodo di inattività prolungato

- Controllo delle batterie del telecomando.
- Nessuna ostruzione alle bocchette di ingresso ed uscita dell'aria.
- Usare il tasto OFF/ON automatico per selezionare la funzione di raffreddamento/riscaldamento. Dopo 15 minuti dal funzionamento, è normale avere la seguente differenza di temperatura tra le bocchette di entrata e di uscita dell'aria:  
Raffreddamento:  $\geq 8^{\circ}\text{C}$       Riscaldamento:  $\geq 14^{\circ}\text{C}$

### Prima di lunghi periodi di inattività

- Spegnerne l'alimentazione e scollegarla.
- Togliere le batterie dal telecomando.

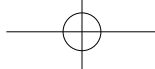

# Soluzione dei problemi

Le condizioni seguenti indicano un guasto.

Condizione	Causa
Sembra che dall'unità interna fuoriesca della nebbia.	• Effetto di condensa dovuto al processo di raffreddamento.
Rumore di acqua durante il funzionamento.	• Flusso del refrigerante all'interno dell'unità.
L'ambiente ha un odore particolare.	• Può essere dovuto a un odore di umido proveniente dai muri, ai tappeti, dai mobili o dagli indumenti presenti nella stanza.
La ventola interna si arresta di tanto in tanto quando si imposta la modalità di regolazione automatica della velocità della ventola.	• Ciò consente di eliminare gli odori circostanti.
Il funzionamento avrà un ritardo di qualche minuto dopo il riavvio.	• Il ritardo è una protezione del compressore dell'apparecchio.
Dall'unità esterna fuoriesce acqua/vapore.	• Condensa o evaporazione nei condotti.
L'unità funziona automaticamente quando l'alimentazione riprende dopo un'interruzione di elettricità.	• È la funzione di riavvio automatico dell'unità. Il funzionamento si riavvia automaticamente secondo la precedente modalità di funzionamento e la direzione del flusso dell'aria quando l'alimentazione riprende poiché il funzionamento non è interrotto dal telecomando.
La ventola interna si arresta di tanto in tanto quando si imposta la modalità riscaldamento.	• Funzionalità studiata per evitare un effetto di raffreddamento non intenzionale.
L'indicatore POWER lampeggia prima che l'unità si accenda.	• Si tratta di un passo preliminare in vista del funzionamento quando si imposta il timer di accensione.
Rumori di urti durante il funzionamento.	• I cambiamenti di temperatura causano l'espansione/contrazione dell'unità.

Eseguire i controlli seguenti prima di rivolgersi all'assistenza.

Condizione	Controllare
Il funzionamento in modalità FREDDO/CALDO non funziona in modo corretto.	<ul style="list-style-type: none"> <li>• Impostare la temperatura corretta.</li> <li>• Chiudere tutte le porte e finestre.</li> <li>• Pulire o sostituire i filtri.</li> <li>• Eliminare le eventuali ostruzioni alle bocchette di ingresso ed uscita dell'aria.</li> </ul>
Rumore durante il funzionamento.	<ul style="list-style-type: none"> <li>• Verificare che l'unità sia stata installata in maniera inclinata.</li> <li>• Chiudere correttamente il pannello anteriore.</li> </ul>
Il telecomando non funziona. (Il display è oscurato oppure il segnale di trasmissione è debole.)	<ul style="list-style-type: none"> <li>• Inserire le batterie in maniera corretta.</li> <li>• Sostituire le batterie quasi scariche.</li> </ul>
L'apparecchio non funziona.	<ul style="list-style-type: none"> <li>• Verificare se è stato attivato l'interruttore di circuito.</li> <li>• Verificare se sono stati impostati i timer.</li> </ul>
L'unità non riceve il segnale dal telecomando.	<ul style="list-style-type: none"> <li>• Assicurarsi che il ricevitore non sia ostruito.</li> <li>• Alcune luci fluorescenti potrebbero interferire con il trasmettitore di segnale. Consultare un rivenditore autorizzato.</li> </ul>

## FUNZIONAMENTO ANOMALO

SPEGNERE L'ALIMENTAZIONE E SCOLLEGARE, quindi consultare un concessionario autorizzato nelle seguenti condizioni:

- Durante il funzionamento si sentono rumori anomali.
- Penetrazione di acqua o di corpi estranei nel telecomando.
- L'unità interna perde acqua.
- L'interruttore salvavita scatta frequentemente.
- Il cavo di alimentazione su surriscalda in modo anomalo.
- Funzionamento anomalo di interruttori o pulsanti.
- La spia del timer lampeggia e l'unità non può essere azionata.

## L'unità si arresta e la spia del TIMER lampeggia.

Usare il telecomando per vedere il codice di errore.

1 Premere per 5 secondi.

2 Premere finché non si sente un "beep", quindi annotare il codice di errore.

3 Premere per uscire dal controllo.

4 Spegner l'unità e mostrare il codice di errore al rivenditore autorizzato.



# Guia rápido

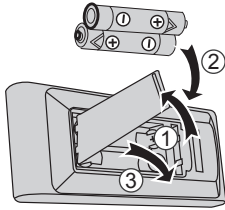

## Colocar as baterias

- ① Remova a tampa da bateria
- ② Introduza pilhas AAA ou R03 (pode ser utilizado ~ 1 ano)
- ③ Feche a tampa

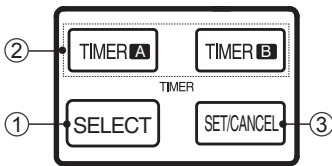

## Configurar TEMPORIZADOR

- ① Pressionar em SELECT (Selecionar)
- ② Configurar a hora
- ③ Confirmar

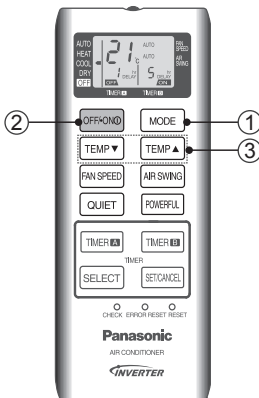

## Funcionamento básico

- ① Selecciono o modo de funcionamento pretendido



- ② Ligue/Desligue a unidade



- Tenha em atenção que a indicação OFF é a seguinte:

Para iniciar:  OFF

Para parar:  OFF

- ③ Programe a temperatura desejada

- Intervalo de seleção: 16 °C ~ 30 °C.
- Se o aparelho funcionar de acordo com a temperatura recomendada pode poupar energia.
- HEAT (CALOR): 20 °C ~ 24 °C .
- COOL (FRIO) : 26 °C ~ 28 °C .
- DRY (SECO) : 1 °C ~ 2 °C inferiores à temperatura do espaço.

- Use o controlo remoto num raio de 8m desde o receptor de controlo remoto do aparelho interior.

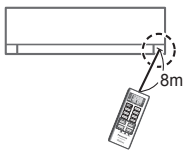

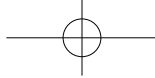

## Índice

Precauções de segurança.....	<b>36-37</b>
Como usar.....	<b>38-39</b>
Instruções de limpeza.....	<b>40</b>
Resolução de problemas.....	<b>41</b>
Especificação do Produto.....	<b>50</b>
Informação.....	<b>Tampa traseira</b>

### Acessórios

- Controlo Remoto
- Baterias AAA ou R03 × 2



# Precauções de segurança

Para evitar ferimentos pessoais, ferimentos em terceiros ou danos materiais, por favor, respeite o seguinte: O funcionamento incorreto devido ao não cumprimento das instruções em baixo pode causar prejuízos ou danos, cuja gravidade é classificada em baixo:

	<b>AVISO</b>	Este símbolo indica perigo de morte ou ferimento grave.
	<b>CUIDADO</b>	Este símbolo indica perigo de ferimento ou danos de bens.

As instruções a seguir são classificadas com os seguintes símbolos:

	Este símbolo indica uma ação PROIBIDA.
	Estes símbolos indicam ações OBRIGATORIAS.

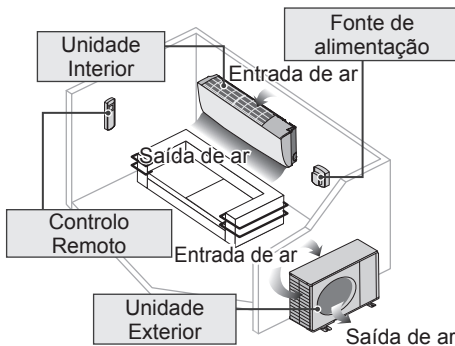

## AVISO

### Unidade interior e unidade exterior



Este dispositivo não se destina ao uso por pessoas (incluindo crianças) com reduzidas capacidades físicas, sensoriais ou mentais, ou falta de experiência e conhecimento, exceto se tiverem supervisão ou instrução relacionadas com o uso do dispositivo por uma pessoa responsável pela sua segurança. As crianças devem ser supervisionadas para assegurar que não brincam com o dispositivo.

Por favor consulte o representante autorizado ou especialista para limpar as partes internas, reparar, instalar, remover e reinstalar a unidade. A instalação inadequada e manutenção pode provocar fuga, choque elétrico ou incêndio.

Confirme com o representante autorizado ou especialista sobre o uso de qualquer tipo de refrigerante específico.

Usar um refrigerante diferente do especificado pode causar danos no produto, explosões e ferimentos, etc.



Não instale a unidade numa ambiente potencialmente explosivo ou inflamável. Se não fizer isso, pode provocar incêndio por acidente.

Não coloque os seus dedos ou outros objetos na unidade de ar condicionado interior ou exterior, as partes rotativas podem provocar ferimentos.



Não toque na unidade exterior em caso de relâmpagos, pode provocar choque elétrico.

Para evitar frio excessivo não se exponha diretamente ao ar frio durante um longo período de tempo.

Não se sente na unidade ou utilize-a como um degrau, pode cair acidentalmente.



### Controlo remoto



Não deixe as crianças brincar com o controlo remoto para impedir que engulam acidentalmente as pilhas.

### Fonte de alimentação



Não use um cabo modificado, cabo de articulação, extensão ou cabo indeterminado para evitar o sobreaquecimento e incêndio.



Para prevenir sobreaquecimento, fogo ou choque elétrico:

- Não compartilhe a mesma tomada eléctrica com outro equipamento.
- Não opere a unidade com as mãos molhadas.
- Não dobre o cabo de alimentação
- Não opere ou desligue a unidade introduzindo ou puxando o cabo de alimentação da tomada.



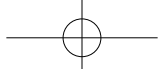

## AVISO

### Fonte de alimentação



Se o cabo fornecido estiver danificado, tem de ser substituído pelo fabricante, agente autorizado ou alguém igualmente qualificado de maneira a evitar riscos.

É fortemente recomendada a instalação do Disjuntor com fuga à terra (ELCB) ou um Dispositivo de Corrente Residual (RCD) para evitar choque elétrico ou incêndio.

Para prevenir sobreaquecimento, fogo ou choque elétrico:

- Introduza o cabo de alimentação corretamente.
- O pó da tomada deve ser limpo periodicamente com um pano seco.

Não utilize o produto se ocorrer alguma anomalia/falha e desligue o cabo de alimentação ou desligue o interruptor ou o disjuntor.

(Risco de fumo/fogo/choque elétrico)

Exemplos de anomalias/falhas

- Se ELCB dá problemas frequentemente.
  - Se sentir o cheiro a queimado.
  - Se ouvir barulho anormal ou vibração da unidade.
  - Se sair água da unidade interior.
  - Se o cabo de alimentação ou a tomada ficarem anormalmente quentes.
  - Se não conseguir controlar a velocidade da ventoinha.
  - Se a unidade deixar de funcionar imediatamente, ainda que ligada.
  - Se a ventoinha não parar, ainda que desligada.
- Contacte o seu fornecedor local imediatamente para manutenção/reparação.

A substituição ou a instalação de tomadas deverá ser efectuada apenas por pessoal autorizado/qualificado. Os fios do cabo de alimentação são coloridos, de acordo com o seguinte código:

Terminais	fios	cores (Padrão CEI)
<b>L</b>	Vermelho	vivo marrom
<b>N</b>	Preto	neutro azul
<b>E</b>	Verde/Amarelo	terra verde-amarelo

Cores de fios podem variar-se dependente do padrão de cores de fio de cada país.



Este equipamento deve ser ligado com fio de terra para prevenir choques elétricos ou incêndio.



Previna os choques elétricos desligando o fornecimento de energia e retirando a ficha da tomada:



- Antes da limpeza ou manutenção.
- Quando não estiver a ser usado por tempo prolongado ou
- Durante trovoadas anormalmente fortes.



## CUIDADO

### Unidade interior e unidade exterior



Não lave o aparelho interior com água, benzina, diluente ou pó de lavagem para evitar danos ou corrosão do aparelho.



Não utilize o aparelho para a preservação de determinados equipamentos, comida, animais, plantas, arte ou outros objetos. Isso poderá conduzir à deterioração de qualidades, etc.

Não utilize nenhum equipamento de combustível em frente da saída de fluxo de ar para evitar a propagação de fogo.

Para evitar ferimentos, etc., não exponha plantas ou animais domésticos diretamente à saída de ar.

Não toque na rebarba de alumínio afiada, as peças afiadas podem provocar lesões.



Não ligue (ON) a unidade interior quando encera o chão. Após encerrar, areje a divisão adequadamente antes de colocar a unidade a funcionar.

Para prevenir danos na unidade não instale a unidade em áreas com óleos e fumos.

Para evitar ferimentos não desmonte a unidade para limpeza.

Para evitar ferimentos, não suba para uma superfície instável quando estiver a limpar o aparelho.

Não coloque uma jarra ou um recipiente com água em cima do aparelho. A água pode entrar no aparelho e danificar o isolamento. Pode causar um choque elétrico.

Durante o funcionamento em modo COOL/DRY (FRIO/SECO) não deixe janelas ou portas abertas por longos períodos de tempo.



Evite fugas de água assegurando que o tubo de drenagem é:

- Devidamente colocado,
- Permanece livre de calhas e recipientes ou
- Não está imerso em água

Após uma utilização prolongada ou utilização de qualquer equipamento de combustível, ventile o espaço regularmente.

Após uma utilização prolongada, certifique-se que a instalação da cremalheira não se deteriorou para evitar que o aparelho caia.

### Controlo remoto



Não utilize pilhas recarregáveis (Ni-Cd). Pode danificar o controlo remoto.



Para prevenir mau funcionamento ou danos do controlo remoto:

- Remova as pilhas se não for usar a unidade por um longo período de tempo.
- Introduza pilhas novas do mesmo tipo seguindo as indicações de polaridade indicadas.

### Fonte de alimentação



Não desligue a ficha puxando o cabo para prevenir um choque elétrico.

# Como usar

**OFF/ON** Ligar e desligar o aparelho

**TEMP** Configurar a temperatura

**FAN SPEED** Selecionar velocidade do ventilador (5 opções)

(Visor do controlo remoto)



- Para AUTO, a velocidade da ventoinha interior é ajustada automaticamente de acordo com o modo de operação.

**QUIET** Para desfrutar de um ambiente silencioso

- Esta programação fornece um ambiente silencioso reduzindo o barulho da saída de ar.



Receptor e indicador de controlo remoto

POWER	(VERDE)
TIMER	(LARANJA)
QUIET	(VERDE)
POWERFUL	(VERMELHO)

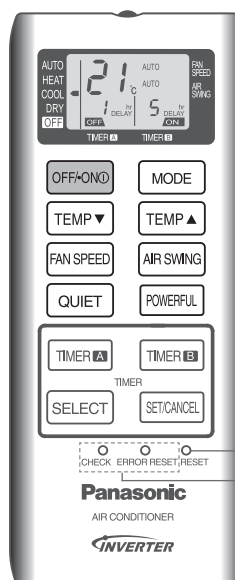

Pressionar para recuperar a configuração predefinida do controlo remoto.  
Não utilizado em operações normais.

## Para ajustar a direcção do fluxo de ar horizontal

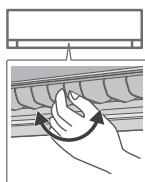

• Ajustável manualmente.

## Botão automático OFF/ON (Desligar/Ligar)



Use quando o controlo remoto está fora do lugar ou avariado. Levante o painel frontal:

- Para usar o modo AUTO, pressione o botão uma vez.
- Para usar o modo COOL (FRIO), pressione mantendo o botão até ouvir 1 bip, depois solte o botão.
- Para usar o modo HEAT (QUENTE), pressione mantendo o botão até ouvir 1 bip, depois solte o botão. Pressione novamente até ouvir 2 bips e solte o botão.
- Pressione novamente o botão para desligar.

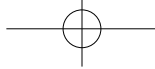
**MODE**

## Para seleccionar o modo de operação

### Mode AUTOMÁTICO - Para sua conveniência

- Durante a seleção do modo de funcionamento o indicador de potência pisca.
- A unidade selecciona o modo de funcionamento de acordo com a temperatura do interior e com a temperatura do controlo remoto.

### Mode de AQUECIMENTO - Para desfrutar de ar quente

- No modo de calor, a unidade pode demorar um pouco a aquecer.

### Mode de ARREFECIMENTO - Para desfrutar de ar fresco

- Para reduzir o consumo energético durante o modo COOL (FRIO), use cortinas para filtra a luz solar e o calor exterior.

### Mode SECO - Para desumidificar o ambiente

- A unidade opera a uma velocidade baixa da ventoinha para dar uma refrigeração suave.

**AIR SWING**

## Para ajustar a direcção do fluxo de ar vertical (5 opções)

(Visor do controlo remoto)



- Mantem o espaço ventilado.
- No modo COOL (FRIO), se é definido o AUTO, as grelhas oscilam automaticamente para cima e para baixo.
- No modo HEAT (CALOR), se estiver definido AUTO, a alavanca horizontal fixa-se numa posição predeterminada.
- Não ajuste as grelhas manualmente.

**POWERFUL**

## Para alcançar a temperatura rapidamente

- Esta programação permite alcançar rapidamente a temperatura desejada.

NOTA: Os modos POWERFUL e QUIET não podem ser activados ao mesmo tempo.

## Para ajustar o temporizador

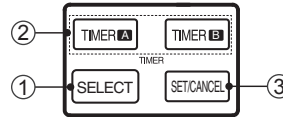

- Para LIGAR o aparelho numa hora programada. Configure o temporizador enquanto o aparelho está DESLIGADO.
- Para DESLIGAR o aparelho numa hora programada. Configure o temporizador enquanto o aparelho está LIGADO.

- ① Pressione uma vez o temporizador seleccionado.
- ② Pressione **TIMER A** / **TIMER B** várias vezes para configurar a hora desejada.
- ③ Pressione uma vez para confirmar.

- Para LIGAR e depois DESLIGAR o aparelho numa hora programada. Configure os temporizadores enquanto o aparelho está DESLIGADO.

- Para DESLIGAR e depois LIGAR o aparelho numa hora programada. Configure os temporizadores enquanto o aparelho está LIGADO.

- ① Pressione duas vezes os temporizadores seleccionados.
- ② Pressione **TIMER A** / **TIMER B** várias vezes para configurar a hora desejada.
- ③ Pressione uma vez para confirmar.

- Pressione de novo o botão **SET/CANCEL** para cancelar a operação do temporizador.

- O temporizador será também cancelado quando pressionar o botão **OFF/MONO**.

- O indicador do temporizador no aparelho interior irá acender durante o funcionamento do temporizador.

- Quando o indicador de temporizador estiver ligado, o aparelho pode ligar-se antes da hora predefinida de forma a ser alcançada a temperatura desejada a tempo.

- Se o temporizador é cancelado manualmente ou devido a uma falha de corrente, você pode restaurar o temporizador novamente, repetindo os passos acima (depois de reiniciação de poder).

Como usar

Português

## Condição de funcionamento

Utilize este ar condicionado com o seguinte intervalo de temperatura

Temperatura (°C)		Interior		Exterior	
		*DBT	*WBT	*DBT	*WBT
RESFRIAMENTO	Máxima	32	23	43	26
	Mínima	16	11	-10	11
AQUECIMENTO	Máxima	30	-	24	18
	Mínima	16	-	-15	-6

DBT: Temperatura de bolbo Seco  
WBT: Temperatura de bolbo Húmido

ATENÇÃO: • Este modelo não pode funcionar durante 24 horas continuamente no modo de aquecimento a menos de -15 °C. Quando a temperatura exterior for inferior a -15 °C e usar este modelo fora das condições de cima, a unidade exterior pode congelar-se e parar o funcionamento para controlo de protecção.

39



# Instruções de limpeza

**Para assegurar um ótimo desempenho do aparelho, a limpeza deve ser efectuada a intervalos regulares.**

- Desligue o fornecimento elétrico e desligue a ficha da tomada antes de limpar.
- Não toque nas alhetas de alumínio, a parte afiada pode causar ferimentos.
- Não utilize benzina, diluente nem pó de limpeza abrasivo.
- Utilize apenas sabões (≈ pH7) ou detergente de uso doméstico neutro.
- Não utilize água com uma temperatura superior a 40 °C.

## Unidade interior

Painel frontal

Alhetas de alumínio

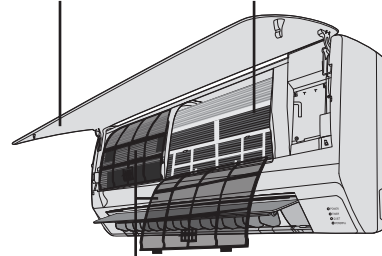

Filtro do ar

### Unidade interior

Limpe cuidadosamente a unidade com um pano macio e seco.



### Filtro do ar

Limpe os filtros regularmente

- Lave/passe os filtros suavemente por água para evitar a ocorrência de danos na superfície do filtro.
- Seque os filtros cuidadosamente à sombra, longe do fogo ou da luz solar directa.
- Substitua os filtros danificados.



### Painel frontal

Lave-o com cuidado e seque-o.

#### Retire o painel frontal

② Retire

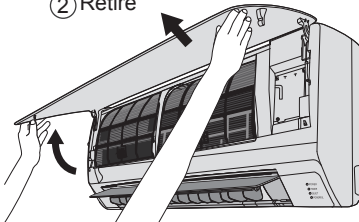

① Eleve

#### Feche-o com firmeza

③ Pressione ambas as extremidades no painel frontal

① Insira em ambos os lados

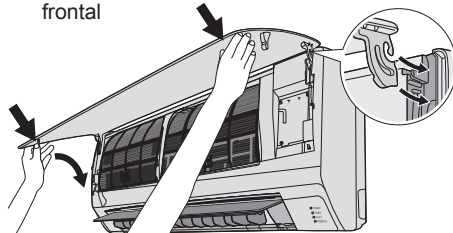

② Feche

#### Retire o filtro de ar

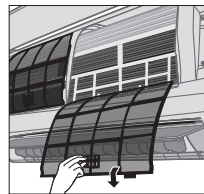

#### Coloque o filtro de ar

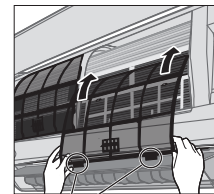

Coloque no aparelho

### Para uma inspecção sazonal após não utilização prolongada

- Verifique as pilhas do controlo remoto.
- Os orifícios de entrada e saída devem estar desobstruídos.
- Use a tecla Auto OFF/ON (Ligar/Desligar automático) para seleccionar a operação de Arrefecimento/Aquecimento (COOL/HEAT). Após 15 minutos de funcionamento, é normal ter a seguinte diferença de temperatura entre as aberturas de ventilação de entrada e saída de ar:  
Arrefecimento:  $\geq 8\text{ }^{\circ}\text{C}$       Aquecimento:  $\geq 14\text{ }^{\circ}\text{C}$

### Para preparar a unidade para um período de inatividade prolongado

- Desligue o fornecimento elétrico e desligue a ficha da tomada.
- Remova as pilhas do controlo remoto.

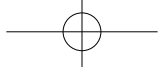

# Resolução de problemas

Os seguintes sintomas não indicam uma avaria do aparelho.

Sintoma	Causa
Sai névoa da unidade interior.	• Efeito de condensação devido ao processo de arrefecimento.
Ouve-se o fluxo de água quando a unidade está a funcionar.	• Fluxo do líquido de refrigeração no interior da unidade.
A sala tem um odor estranho.	• Pode ser devido a um odor de humidade produzido pela parede, alcatifa, mobília ou vestuário.
O ventilador interior pára ocasionalmente quando o modo de velocidade automática do ventilador está programado.	• Isto ajuda a remover os odores do ambiente.
O funcionamento atrasa alguns minutos após o reinício.	• O atraso é um mecanismo de proteção do compressor da unidade.
A unidade exterior produz água/vapor.	• Existe condensação ou evaporação nos tubos.
A unidade funciona automaticamente quando a corrente é reposta depois da falha de corrente.	• É a função de reiniciar automaticamente (Auto Restart) a unidade. Quando a corrente for reposta a operação vai ser automaticamente reiniciada no modo da operação e direção do fluxo de ar anteriores, pois a operação não está cancelada com o controlo remoto.
O ventilador interior pára ocasionalmente no modo de aquecimento.	• Para evitar o efeito de arrefecimento accidental.
O indicador de alimentação pisca antes da unidade ser ligada.	• Este é um passo preliminar para a operação, quando o temporizador ON estiver definido.
Som de quebra durante o funcionamento.	• Mudanças de temperatura causam a expansão/contracção da unidade.

Verifique os seguintes antes de pedir assistência.

Sintoma	Verificar
O funcionamento no modo COOL/HEAT (FRIO/QUENTE) não está a funcionar eficazmente.	<ul style="list-style-type: none"> <li>• Configure a temperatura corretamente.</li> <li>• Feche todas as portas e janelas.</li> <li>• Limpe ou substitua os filtros.</li> <li>• Limpe qualquer obstrução que se encontra na entrada do ar e nas aberturas de ventilação de saída do ar.</li> </ul>
Ruído durante o funcionamento.	<ul style="list-style-type: none"> <li>• Certifique-se de que a unidade foi instalada numa inclinação.</li> <li>• Feche o painel dianteiro devidamente.</li> </ul>
O controlo remoto não funciona. (O visor está escuro ou o sinal de transmissão está fraco.)	<ul style="list-style-type: none"> <li>• Introduza as pilhas devidamente.</li> <li>• Substitua as pilhas gastas.</li> </ul>
A unidade não funciona.	<ul style="list-style-type: none"> <li>• Verifique se o disjuntor disparou.</li> <li>• Verifique se o temporizador foi configurado.</li> </ul>
A unidade não recebe o sinal do controlo remoto.	<ul style="list-style-type: none"> <li>• Certifique-se que o receptor não está obstruído.</li> <li>• Algumas luzes fluorescentes podem interferir com o transmissor de sinal. Consulte o revendedor autorizado.</li> </ul>

## CRITÉRIOS SEM MANUTENÇÃO

DESLIGUE O FORNECIMENTO ELÉTRICO E DESLIGUE A FICHA DA TOMADA e consulte depois um representante autorizado nas seguintes condições:

- Ruído anormal durante o funcionamento.
- Água/partículas estranhas entraram no controlo remoto.
- Fuga de água da unidade interior.
- Os interruptores do disjuntor desligam-se frequentemente.
- O fio distribuidor de corrente aquece de forma anormal.
- Os interruptores ou botões não estão a funcionar devidamente.
- O indicador de temporizador pisca e a unidade não funciona.

## O aparelho pára e o indicador do TEMPORIZADOR pisca.

Utilize o controlo remoto para obter o código de erro.

- 1 Prima durante 5 segundos.
- 2 Prima até ouvir um sinal sonoro e, em seguida, anote o código de erro.
- 3 Prima para sair da verificação.
- 4 Desligue a unidade e indique o código de erro ao revendedor autorizado.

# Бърз справочник

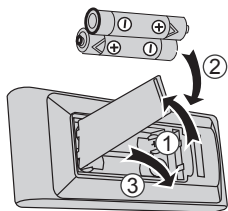

## Поставяне на батериите

- ① Свалете капака за батериите
- ② Поставете AAA или R03 батерии (могат да се използват приблизително една година)
- ③ Затворете капака

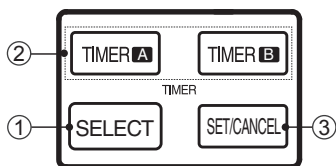

## настройка на ТАЙМЕР

- ① Натиснете ИЗБОР
- ② Настройте часа
- ③ Потвърдете

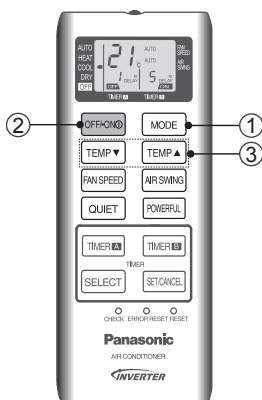

## Основни функции

- ① Избор на желаня режим на работа  
**AUTO** → **HEAT** → **COOL** → **DRY**

- ② Включване/спиране



- Имайте предвид, че индикаторът **ИЗКЛЮЧЕН** работи както следва:  
 За да започнете: **OFF** **ON**  
 За да спрете: **ON** **OFF**

- ③ **Настройка на желаната температура**

- Обхват на избор: 16°C ~ 30°C.
- Поддържането на устройството в рамките на препоръчителната температура може да спести енергия.
- ОТОПЛЕНИЕ: 20°C ~ 24°C.
- ОХЛАЖДАНЕ: 26°C ~ 28°C.
- ИЗСУШАВАНЕ: 1°C ~ 2°C по-ниско от стайната температура

- Използвайте дистанционното управление на разстояние до 8 метра от приемника на дистанционното за вътрешното тяло.

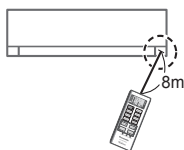

Илюстрациите в това ръководство са предназначени само за разяснение и могат да се различават от действителния уред. Възможни са промени без предупреждение за бъдещи подобрения.

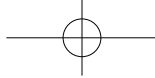

## Съдържание

Предпазни мерки .....	44-45
Начин на употреба .....	46-47
Инструкции за почистване .....	48
Отстраняване на проблеми .....	49
Продуктова спецификация.....	50
Информация.....	Последна страница

### Акcesoари

- Дистанционно управление
- Батерии AAA или R03 × 2

# Предпазни мерки

С цел да предотвратите нараняване на себе си, други хора или нанасяне на материални щети, моля, придържайте се към следните инструкции: Неправилната експлоатация поради неспазването на инструкциите по-долу може да причини нараняване или щети, сериозността на които се степенува както следва:

	<b>ПРЕДУПРЕЖДЕНИЕ</b>	Този знак предупреждава за опасност от смърт или тежки наранявания.
--	-----------------------	---

	<b>ВНИМАНИЕ</b>	Този знак предупреждава за опасност от наранявания или имуществени щети.
--	-----------------	--

Инструкциите, които трябва да се спазват, са класифицирани със следните символи:

	Този символ обозначава съответното действие като <b>ЗАБРАНЕНО</b> .
--	---

   	Тези символи обозначават, че съответните действия са <b>ЗАДЪЛЖИТЕЛНИ</b> .
--------------	--

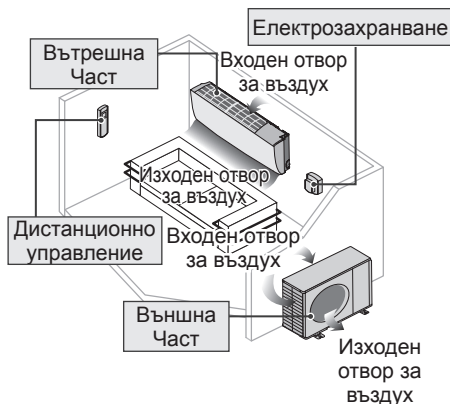

## ПРЕДУПРЕЖДЕНИЕ

### Вътрешен и външен модул



Уредът не е предназначен за използване от хора (вкл. деца) с намалени физически, сетивни или психични проблеми или нямащи съответния опит и познания, докато не бъдат инструктирани или наблюдавани от човек, отговорен за безопасността, за начина на използване на уреда. Наблюдавайте децата, за да се уверите, че не си играят с уреда.

Моля, посъветвайте се с оторизиран дилър или специалист за почистване на вътрешните части, ремонт, монтаж, преместване и повторно инсталиране на уреда. Неправилните монтаж и боравене ще доведат до течове, токов удар или пожар.

Съгласувайте използването на избрания от вас тип охладител с официален дилър или специалист.

Използването на охладител, който е различен от указания, може да доведе до повреда на устройството, експлозия, нараняване и др.



Не монтирайте модула в помещения с потенциално експлозивна или запалима атмосфера. В противен случай може да се стигне до пожар.

Не пъхайте пръстите си или други обекти във вътрешния или външния модул на климатика, въртящите се части могат да предизвикат наранявания.



Не докосвайте външния модул по време на гръмотевична буря, това може да доведе до токов удар.

Не се излагайте директно на студен въздух за продължителен период от време, за да избегнете прекомерно охлаждане.

Не сядайте и не стъпвайте върху модула, тъй като случайно може да паднете.



### Дистанционно управление



Не позволявайте на бебета и малки деца да играят с дистанционното управление, за да ги предпазите от случайно поглъщане на батериите.

### Електрозахранване



Не използвайте видеоизменен кабел, съединен кабел, удължителен кабел или неопределен тип кабел с цел предотвратяване на прегряване и пожар.



За да предотвратите прегряване, пожар или токов удар:

- Не включвайте друго оборудване в същия контакт.
- Не работете с мокри ръце.
- Не прегъвайте захранващия кабел.
- Не пускайте и не спирате уреда чрез включване или изключване от щепсела.



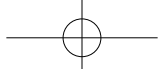

## ПРЕДУПРЕЖДЕНИЕ

### Електрозахранване



С цел предотвратяването на опасност, ако захранващият кабел е повреден, трябва да бъде сменен от производителя, обслужващия ви специалист или друго квалифицирано лице.

Силно препоръчително е да се монтира заземителен автоматичен прекъсвач (ELCB) или устройство за диференциална защита (RCD), за да избегнете токов удар или пожар.

За да предотвратите прегряване, пожар или токов удар:

- Вкарайте добре щепсела.
- Прахът по щепсела на захранващия кабел трябва да се избърсва периодично със суха кърпа.

Преустановете използването на продукта, ако възникне необичайна работа или неизправност, и изключете щепсела на захранващия кабел или прекъсвача на захранването и прекъсвача.

(Риск от дим/пожар/токов удар)

- Примери за необичайна работа/неизправност
- Прекъсвачът на веригата с утечка в земята се включва често.
  - Усеща се миризма на изгоряло.
  - Чува се необичаен шум или се усеща вибрация на уреда.
  - От вътрешния уред тече вода.
  - Захранващият кабел или щепселът се нагорещават необичайно.
  - Скоростта на вентилатора не може да се контролира.
  - Уредът спира да работи незабавно, дори ако е включен за работа.
  - Вентилаторът не спира, дори ако работата е прекратена.

Свържете се незабавно с местния дилър за профилактика/ремонт.

Смяната или монтажа на щепсел на захранващия кабел трябва да се извършва само от оторизиран/квалифициран персонал. Кабелите в този проводник за електрическата мрежа са оцветени съобразно следните общоприети принципи:

Клеме	проводници	цветове (IEC стандарт)
L		фаза
N		неутрален
E		земя

кафяв  
син  
зелен – жълт

Цветът на проводниците може да бъде различен в зависимост от цветния код на стандарта на съответната страна.



С оглед предотвратяване появата на токов удар или пожар, това оборудване трябва да бъде заземено.



Предотвратете появата на токов удар, като изключите електрическото захранване и спрете:



- Преди почистване или обслужване.
- Когато не го използвате продължително или
- По време на необичайно силна буря с мълнии.



## ВНИМАНИЕ

### Вътрешен и външен модул



С оглед избягването на повреда или корозия на вътрешното тяло, не използвайте вода, бензин, разредители или абразивен прах за почистването му.



Не използвайте уреда за съхранение на прецизно оборудване, храна, животни, растения, произведения на изкуството или други предмети. Това може да доведе до влошаване на качеството и т.н.

Не използвайте никакво запалимо оборудване пред въздушния извод, за да предотвратите възникването на пожар.

Не излагайте растения или домашни животни директно на въздушния поток, за да избегнете нараняване и т.н.

Не докосвайте острото алуминиево ребро. Острите части могат да предизвикат наранявания.



Не включвайте вътрешния модул, когато полирате пода. След полиране, проверете стаята добре, преди да използвате модула.

Не монтирайте уреда в мазни и задимени зони, за да избегнете увреждане му.

Не разглобявайте уреда с цел почистване, за да избегнете нараняване.

За да предотвратите нараняване, не стъпвайте върху неустойчива опора, когато почиствате устройството.

Не поставяйте ваза или контейнер, пълен с вода, върху устройството. Водата може да проникне в него и да повреди уплътнението. Това може да причини токов удар.

Докато използвате устройството в режим "COOL/DRY" (ОХЛАЖДАНЕ/ИЗСУШАВАНЕ), не оставяйте продължително време отворени прозорци или врати.



Предотвратете изтичането на вода, като проверите дали отводнителната тръба е:

- Правилно свързана,
- Далече от водосточни тръби и контейнери, както и че не е
- Потопена във вода

След продължителен период на употреба или използване заедно със запалимо оборудване редовно проветрявайте стаята.

За да предотвратите падане на устройството, след продължителен период на употреба редовно започнете да проверявате дали монтажната конзола не се е износила.

### Дистанционно управление



Не използвайте акумулаторни (Ni-Cd) батерии. То може да повреди дистанционното управление.



За да предотвратите неизправност или повреда на дистанционното управление:

- Свалете батериите, ако устройството няма да бъде използвано дълго време.
- Трябва да се поставят нови батерии от същия тип, като се спазва указаната полярност.

### Електрозахранване



За да предотвратите появата на токов удар, не изключвайте щепсела, като за целта издърпате кабела.

# Начин на употреба

OFF/ON

**Включване и изключване на устройството**

TEMP ▼

TEMP ▲

**Настройка на температурата**

FAN SPEED

**За избор на скорост на вентилатора (5 възможности)**

(Дисплеят на дистанционното управление)



- При режим AUTO скоростта на вътрешния вентилатор се настройва автоматично според режима на работа.

QUIET

**За да се насладите на тишината**

- Тази настройка осигурява тиха околна среда чрез намаляване на шума на въздушния поток.



Приемник и индикатор на дистанционното управление

POWER	(ЗЕЛЕН)
TIMER	(ОРАНЖЕВ)
QUIET	(ЗЕЛЕН)
POWERFUL	(ЧЕРВЕН)

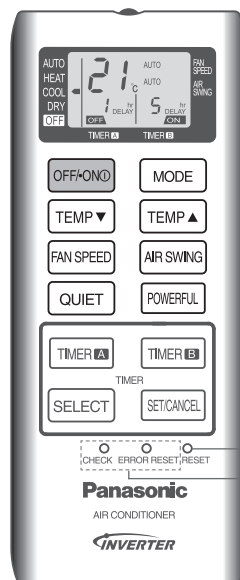

Натиснете, за да възстановите дистанционното управление на настройката му по подразбиране.

Не се използва в нормални режими на работа.

## За настройка на посоката при хоризонтално въздушно течение

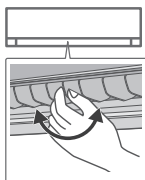

- Регулира се ръчно.

## Бутон за автоматично ВКЛЮЧВАНЕ/ ИЗКЛЮЧВАНЕ



Използвайте, когато дистанционното управление не е на мястото си или не работи. Вдигнете предния панел:

- За да използвате в режим АВТОМАТИЧНО, натиснете бутона веднъж.
- За да използвате в режим ОХЛАЖДАНЕ, натиснете и задръжте бутона, докато чуете 1 звукова сигнализация, след което освободете.
- За да използвате в режим ОТОПЛЕНИЕ, натиснете и задръжте бутона, докато чуете 1 звукова сигнализация, след което освободете. И натиснете отново, докато чуете 2 звукови сигнала, след което освободете.
- За да го изключите, натиснете отново бутона.

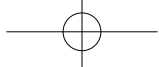

## MODE За да изберете режим на работа

### АВТОМАТИЧЕН режим на работа - За ваше удобство

- По време на избиране на режима на работа индикаторът мига.
- Уредът избира работния режим според вътрешната температура на вентилация и температурата, зададена с дистанционното управление.

### Режим на ОТОПЛЕНИЕ - За да се наслаждавате на топъл въздух

- В режим на отопление може да отнеме известно време, докато уредът загрее.

### Режим на ОХЛАЖДАНЕ - За да се наслаждавате на студен въздух

- За да намалите консумацията на енергия в режим ОХЛАЖДАНЕ, използвайте пердетата, за да елиминирате слънчевата светлина и топлина, идващи отвън.

### Режим на МЕКО ИЗСУШАВАНЕ - За да се насладите на тиха среда

- Уредът работи на ниска скорост, за да гарантира умерено охлаждане на въздуха.

## AIR SWING За настройка на посоката при вертикално въздушно течение (5 опции)

(Дисплеят на дистанционното управление)



- Запазва стаята проветрена.
- В режим ОХЛАЖДАНЕ режим АВТОМАТИЧНО, вентилационният отвор започва да се движи нагоре/надолу автоматично.
- В режим HEAT (ОТОПЛЕНИЕ), ако е настроен режим AUTO (АВТОМАТИЧЕН), хоризонталните жалузи се фиксират в предварително настроената позиция.
- Не регулирайте с ръка вентилационния отвор.

## POWERFUL За бързо постигане на желаната температура

- Тази настройка дава възможност за бързо достигане на желаната температура.

**ЗАБЕЛЕЖКА:** МОЩНА И ТИХА работа не могат да се постигнат едновременно.

## Настройка на таймера

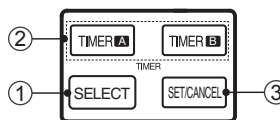

- За да ВКЛЮЧИТЕ устройството в предварително зададен час. Настройте таймера, докато климатикът е ИЗКЛЮЧЕН.

- За да ИЗКЛЮЧИТЕ устройството в предварително зададен час. Настройте таймера, докато климатикът е ВКЛЮЧЕН.

- 1 Натиснете веднъж, за да изберете таймера.
- 2 Натиснете **TIMER A** / **TIMER B** и задръжте, за да настроите желаните от вас час.
- 3 Натиснете веднъж, за да потвърдите.

- За да ВКЛЮЧИТЕ и след това да ИЗКЛЮЧИТЕ устройството в предварително указани час. Настройте таймерите, докато климатикът е ИЗКЛЮЧЕН.

- За да ИЗКЛЮЧИТЕ и след това да ВКЛЮЧИТЕ устройството в предварително указани час. Настройте таймерите, докато климатикът е ВКЛЮЧЕН.

- 1 Натиснете два пъти, за да изберете таймерите.
- 2 Натиснете **TIMER A** / **TIMER B** и задръжте, за да настроите желаните от вас час.
- 3 Натиснете веднъж, за да потвърдите.

- Натиснете бутона **SET/CANCEL** отново, за да отмените работата на таймера.

- Таймерът ще се отмени и когато натиснете бутона **OFF/ON/OFF**.

- Индикаторът на таймера на вътрешното тяло ще светне, докато работи таймерът.

- Когато таймерът за ВКЛЮЧВАНЕ е настроен, уредът може да започне по-рано от определеното време, за да може да достигне желаната температура навреме.

- Ако таймерът бъде отменен ръчно или поради отпадане на захранването, можете да го възстановите отново, като повторите горепосочените стъпки (след възстановяване на захранването).

## Работна среда

Използвайте този климатик в следните температурни граници.

Температура (°C)		В закрито помещение		На открито	
		*DBT	*WBT	*DBT	*WBT
ОХЛАЖДАНЕ	Максимум	32	23	43	26
	Минимум	16	11	-10	11
ОТОПЛЕНИЕ	Максимум	30	-	24	18
	Минимум	16	-	-15	-6

DBT: Температура без отчитане влажността на въздуха  
WBT: Температура с отчитане влажността на въздуха

- ЗАБЕЛЕЖКА:** • Този модел не е подходящ за непрекъсната 24-часова работа в режим на отопление под -15°C. Когато външната температура е под -15°C, а Вие използвате този модел извън гореспоменатите условия, външният агрегат може да замръзне и да спре работа с цел контрол на защитата.



# Инструкции за почистване

**За да осигурите оптимална експлоатация на устройството, трябва редовно да го почиствате.**

- Преди почистване изключете електрическото захранване и извадете щепсела.
- Не докосвайте алуминиевото ребро, острата част може да причини нараняване.
- Не използвайте бензин, разреждател или абразивни прахове.
- Използвайте само сапуни ( $\approx$  pH7) или неутрални домакински прахове.
- Не използвайте вода, по-гореща от 40°C.

## Вътрешна част

Преден панел

Алуминиево ребро

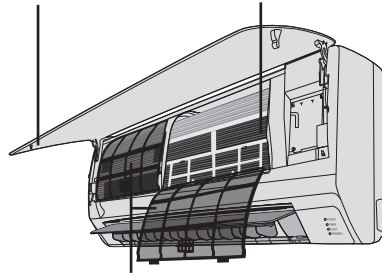

Въздушен филтър

## Вътрешна част

Внимателно забършете уреда с мек, сух парцал.



## Въздушен филтър

Почиствайте филтрите редовно

- Внимателно почистете/измийте филтрите с вода, за да не нараните повърхността им.
- Подсушете добре филтрите на сянка, далеч от запален огън или пряка слънчева светлина.
- Сменете повредените филтри, ако има такива.



## Преден панел

Измийте го внимателно и го подсушете.

### Свалете предния панел

② Издърпайте

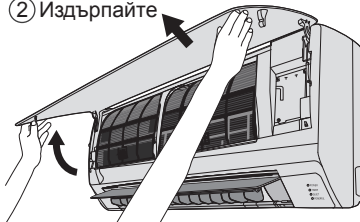

① Вдигнете

### Извадете въздушния филтър

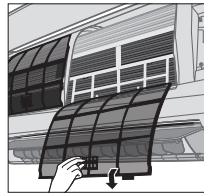

### Поставете въздушен филтър

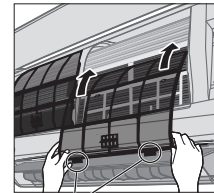

Поставете го в устройството

### Затворете го добре

③ Натиснете и двата края на предния панел

① Поставете и от двете страни

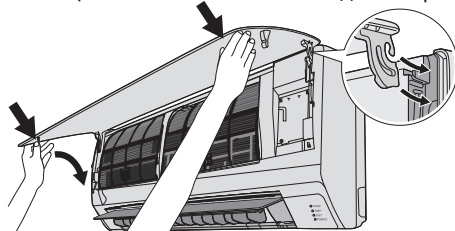

② Затворете

### При сезонен преглед след продължително неизползване

- Проверка на батериите на дистанционното управление.
- Никакви прегради на входните и изходни вентилационни отвори.
- Използвайте бутона за автоматично ВКЛ./ИЗКЛ. (Auto OFF/ON), за да изберете режим на охлаждане/отопление. Нормално е. След 15 минути работа, да имате следната температурна разлика между отворите за входящ и изходящ въздух:  
Охлаждане:  $\geq 8^{\circ}\text{C}$       Отопляване:  $\geq 14^{\circ}\text{C}$

### При продължително неизползване

- Изключете електрическото захранване и извадете щепсела.
- Извадете батериите на дистанционното управление.

# Отстраняване на проблеми

Следните симптоми при работата на уреда не означават неизправност.

Симптом	Причина
От вътрешната част излиза замъглен въздух.	• Кондензиране поради процеса на охлаждане.
Звук от течаща вода по време на работа.	• Охлаждаща течност вътре в уреда.
Стаята има странна миризма.	• Това може да е миризмата на влагата, отделяна от стените, килима, мебелите или дрехите.
Вътрешният вентилатор спира от време на време при настройка за автоматично регулиране на скоростта.	• Това спомага за отстраняване на околните миризми.
След рестартиране включването се забавя с няколко минути.	• Закъснението служи за защита на компресора на уреда.
Външната част отделя вода/пара.	• По тръбите се получава кондензация или изпаряване.
Уредът се включва автоматично след възстановяване на захранването след спиране на тока.	• Това е функцията „автоматично рестартиране“ на устройството. Работата се възстановява автоматично в предишния режим и посока на въздушния поток, ако не бъде прекратена с дистанционното управление.
Вътрешният вентилатор спира от време на време при отопляване.	• С цел да се избегне нежелан охлаждащ ефект.
Индикаторът за захранване мига преди уредът да се включи.	• Това е предварителна стъпка в подготовката за работа, когато ON таймерът е бил зададен.
Пукане по време на работа.	• Температурните промени могат да доведат до разширяване или свиване на уреда.

Проверете следните неща, преди да се обадите на оторизиран сервис.

Симптом	Проверка
Функционирането в режим ОХЛАЖДАНЕ/ЗАГРЯВАНЕ не е ефективно.	<ul style="list-style-type: none"> <li>• Задайте правилно температурата.</li> <li>• Затворете всички врати и прозорци.</li> <li>• Почистете или сменете филтрите.</li> <li>• Почистете входните и изходни вентилационни отвори.</li> </ul>
Шум по време на работа.	<ul style="list-style-type: none"> <li>• Проверете дали уредът не е монтиран под наклон.</li> <li>• Затворете правилно предния панел.</li> </ul>
Дистанционното управление не работи. (Дисплеят е изгаснал или предавателният сигнал е слаб.)	<ul style="list-style-type: none"> <li>• Поставете правилно батериите.</li> <li>• Сменете изхабените батерии.</li> </ul>
Уредът не работи.	<ul style="list-style-type: none"> <li>• Проверете дали автоматичният прекъсвач е изключен.</li> <li>• Проверете дали таймерът е настроен.</li> </ul>
Уредът не получава сигнали от дистанционното управление.	<ul style="list-style-type: none"> <li>• Уверете се, че няма прегради.</li> <li>• Някои флуоресцентни светлини могат да доведат до смущения при предаването на сигнала. Моля обърнете се към оторизиран дилър.</li> </ul>

## КРИТЕРИИ ЗА ПОВРЕДА

ИЗКЛЮЧЕТЕ ЕЛЕКТРИЧЕСКОТО ЗАХРАНВАНЕ И ИЗВАДЕТЕ ЩЕПСЕЛА, след което се свържете с официален дилър в следните ситуации:

- Необичаен звук по време на работа.
- Вода/чужди частици са попаднали в дистанционното управление.
- Изтича вода от Вътрешния уред.
- Прекъсвачът на ел. верига се изключва често.
- Захранващият кабел се загрява необичайно.
- Копчетата или бутоните не функционират правилно.
- Индикаторът на таймера мига и устройството не работи.

## Устройството спира работа и индикаторът на ТАЙМЕРА мига.

Използвайте дистанционното управление, за да получите кода за грешка.

1 Натиснете за 5 секунди.









2 Натиснете, докато чуете едно пукане, след което си запишете кода за грешка.

3 Натиснете за 5 секунди, за край на проверката.

4 Изключете модула и покажете кода за грешка на оторизирания дилър.







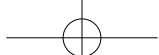

# Product Specification

- INDOOR UNIT
- OUTDOOR UNIT

 Model		<input type="checkbox"/> CS-RE9PKE-3		<input type="checkbox"/> CS-RE12PKE-3		<input type="checkbox"/> CS-RE15PKE-3		
		<input type="checkbox"/> CU-RE9PKE-3		<input type="checkbox"/> CU-RE12PKE-3		<input type="checkbox"/> CU-RE15PKE-3		
		COOL	HEAT	COOL	HEAT	COOL	HEAT	
		Single, 230V,50Hz		Single, 230V,50Hz		Single, 230V,50Hz		
 Power/Current	[kW]	0.700	0.820	1.010	1.120	1.260	1.385	
	[A]	3.30	3.80	4.70	5.20	6.00	6.30	
 Refrigerant	[kg]	0.770		0.860		0.920		
 Cooling Capacity	[kW]	2.50		3.50		4.20		
 Heating Capacity	[kW]	3.30		4.25		5.00		
 Noise Level	JIS C 9612 [<70 dB(A)]	<input type="checkbox"/>	42	42	42	42	44	46
	Conditions 1m Distance Max. cooling/ heating operation	<input type="checkbox"/>	47	48	48	50	49	51
	Sound power level	<input type="checkbox"/>	58	58	58	58	60	62
		<input type="checkbox"/>	63	64	64	66	65	67
 Air Circulation	[m <sup>3</sup> /min.]	12.5	11.1	12.5	12.5	13.7	14.5	
 Product Weight	[kg]	<input type="checkbox"/>	8.0		8.0		8.0	
		<input type="checkbox"/>	23		26		27	
 Dimensions (H x W x D)	[mm]	<input type="checkbox"/>	290×848×213		290×848×213		290×848×213	
		<input type="checkbox"/>	540×780×289		540×780×289		540×780×289	

- Standby power consumption ≤ 7.5W (when switched OFF by remote control, except under self-protection control).
- Standard piping length: 5m.
- Air filters are attached.



Translations	Deutsch	Français	Italiano	Nederlands	Português	Español	Български	Hrvatski
Product Specification	Produktbeschreibung	Caractéristiques du produit	prescrizioni dell' prodotto	productkenmerken	Especificações do produto	Especificación de producto	Описаније на произв	Specifikacija proizvoda
 Model Indoor Unit  Outdoor Unit	Modell Innengerät Aussergerät	Modèle Unité intérieure Unité extérieure	Modello Impianto interno Impianto esterno	Model Binnenmitching Buitenmitching	Modelo Elemento interior Elemento exterior	Modelo Equipo interior Equipo exterior	Модел Внутрашње уређајно Ваншашње уређајно	Модел Унутрашња јединица Ваншашња јединица
	Stromversorgung	Alimentation	Corrente	Stroom	Potência	Corriente	Електрично запознавање	Snaga/strija
	Kühlmittel	Refrigerant	Refrigerante	Koelmiddeel	Refrigerante	Refrigerante	Охлађивач квалитет	Rashladno sredstvo
	Kühlleistung	Capacité réfrigérante	Refrigerazione	Cooling Capacity	Capacidade do resfriamento	Potencia frigorífica	Охлађивач капацитет	Kapacitet hlađenja
	Heizleistung	Capacité chauffage	Riscaldamento	Verwarming Capacity	Capacidade do aquecimento	Potencia calefacción	Загревач капацитет	Kapacitet grijanja
 Noise Level  Conditions Im Abstand 1 m Max. cooling Sound power level	Lärmpegel Bedingungen 1m Abstand 1m Entfernung Schallleistungspegel	Niveau de bruit Conditions Distance 1 m Refrigerant max. Niveau de puissance sonore	Livello di rumore Condizioni Distanza di 1 m Raffreddamento max. Livello rumore	Lawaapeaker Voorwaarden 1m afstand 1m afstand Max. koeling Geluidniveau	Nível do barulho Condições Distância de 1 m Resfriamento max. Nível de alimentação sonora	Nivel sonoro Condiciones 1 m de distancia Max. potencia Nivel de potencia de sonido	Ниво на шума Услови 1m растојане Максимално Ниво на звучаност Ниво на звучност	Razina buke Uvjeti Udaljenost 1 m Maksimalna Razina zvučne snage
	Luftzirkulation	Ventilation	Circolazione aria	Luchtcirculatie	Circulação do ar	Circulación de aire	Ваздушна циркулација	Kuženje zraka
	Produktgewicht	Poids du produit	Peso prodotto	Productgewicht	Peso do produto	Peso del producto	Тешина производа	Težina proizvoda
	Abmessungen	Dimensions	Misure	Afmetingen	Dimensões	Medidas	Размери	Dimenzije

English	• Standby power consumption $\leq 7.5W$ (when switched OFF by remote control, except under self-protection control).
Deutsch	• Stromverbrauch im Standby Modus $\leq 7.5 W$ (wenn durch die Fernbedienung ausgeschaltet, außer bei Selbstschutz-Kontrolle).
Français	• Consommation en mode veille $\leq 7,5 W$ (quand mis en veille par télécommande, sauf sous contrôle d'autoprotection).
Italiano	• Consumo di energia in modalità standby $\leq 7,5 W$ (quando spento dal telecomando, tranne con controllo di autoprotezione).
Nederlands	• Stand-by stroomverbruik $\leq 7,5W$ (indien op OFF geschakeld met afstandsbediening, behalve in de modus zelfbescherming).
Português	• Consumo energético em Standby (modo inactivo) $\leq 7,5W$ (quando colocado em OFF (desligado) com o controlo remoto, exceto em controlo de auto-protectção).
Español	• Consumo de energía en modo de espera $\leq 7,5W$ (cuando se ordena con el mando a distancia, excepto en modo de protección automática).
Български	• Конзумација на енергија во режим на готовност $\leq 7,5 W$ (когато е во режим OFF (ИЗКЛУЧЕН) од дистанционално управлание, с исклучение на случаите, кога се управуваат чез самостојна система за заштита)
Hrvatski	• Potrošnja energije u mirovanju $\leq 7,5 W$ (nakon isključivanja daljinskim upravljačem, osim za upravljanje sa samozastitom).

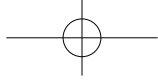

# MEMO

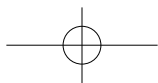
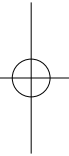



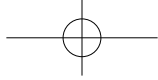

# MEMO

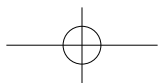
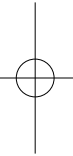



# Information/Informations/Información Informazioni/Informação/Информация

English

## Information for Users on Collection and Disposal of Old Equipment and Used Batteries



These symbols on the products, packaging, and/or accompanying documents mean that used electrical and electronic products and batteries should not be mixed with general household waste.

For proper treatment, recovery and recycling of old products and used batteries, please take them to applicable collection points, in accordance with your national legislation and the Directives 2002/96/EC and 2006/66/EC. By disposing of these products and batteries correctly, you will help to save valuable resources and prevent any potential negative effects on human health and the environment which could otherwise arise from inappropriate waste handling. For more information about collection and recycling of old products and batteries, please contact your local municipality, your waste disposal service or the point of sale where you purchased the items. Penalties may be applicable for incorrect disposal of this waste, in accordance with national legislation.



**For business users in the European Union**  
If you wish to discard electrical and electronic equipment, please contact your dealer or supplier for further information.

### [Information on Disposal in other Countries outside the European Union]

These symbols are only valid in the European Union. If you wish to discard these items, please contact your local authorities or dealer and ask for the correct method of disposal. Note for the battery symbol (bottom two symbol examples):

This symbol might be used in combination with a chemical symbol. In this case it complies with the requirement set by the Directive for the chemical involved.



Pb

Français

## Avis aux utilisateurs concernant la collecte et l'élimination des piles et des appareils électriques et électroniques usagés



Apposé sur le produit lui-même, sur son emballage, ou figurant dans la documentation qui l'accompagne, ce pictogramme indique que les piles et appareils électriques et électroniques usagés doivent être séparés des ordures ménagères.

Afin de permettre le traitement, la valorisation et le recyclage adéquats des piles et des appareils usagés, veuillez les porter à l'un des points de collecte prévus, conformément à la législation nationale en vigueur ainsi qu'aux directives 2002/96/CE et 2006/66/CE. En éliminant piles et appareils usagés conformément à la réglementation en vigueur, vous contribuez à prévenir le gaspillage de ressources précieuses ainsi qu'à protéger la santé humaine et l'environnement contre les effets potentiellement nocifs d'une manipulation inappropriée des déchets.

Pour de plus amples renseignements sur la collecte et le recyclage des piles et appareils usagés, veuillez vous renseigner auprès de votre mairie, du service municipal d'enlèvement des déchets ou du point de vente où vous avez acheté les articles concernés.

Le non-respect de la réglementation relative à l'élimination des déchets est passible d'une peine d'amende.



**Pour les utilisateurs professionnels au sein de l'Union européenne**

Si vous souhaitez vous défaire de pièces d'équipement électrique ou électronique, veuillez vous renseigner directement auprès de votre détaillant ou de votre fournisseur.

### [Information relative à l'élimination des déchets dans les pays extérieurs à l'Union européenne]

Ce pictogramme n'est valide qu'à l'intérieur de l'Union européenne. Pour connaître la procédure applicable dans les pays hors Union Européenne, veuillez vous renseigner auprès des autorités locales compétentes ou de votre distributeur.

Note relative au pictogramme à apposer sur les piles (voir les 2 exemples ci-contre):

Le pictogramme représentant une poubelle sur roues barrée d'une croix est conforme à la réglementation. Si ce pictogramme est combiné avec un symbole chimique, il remplit également les exigences posées par la Directive relative au produit chimique concerné.



Pb

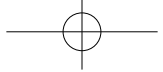

Español

### Información para Usuarios sobre la Recolección y Eliminación de aparatos viejos y baterías usadas



Estos símbolos en los productos, embalajes y/o documentos adjuntos, significan que los aparatos eléctricos y electrónicos y las baterías no deberían ser mezclados con los desechos domésticos.

Para el tratamiento apropiado, la recuperación y el reciclado de aparatos viejos y baterías usadas, por favor, observe las normas de recuperación aplicables, de acuerdo a su legislación nacional y a las Directivas 2002/96/CE y 2006/66/CE.

Al desechar estos aparatos y baterías correctamente, Usted estará ayudando a preservar recursos valiosos y a prevenir cualquier potencial efecto negativo sobre la salud de la humanidad y el medio ambiente que, de lo contrario, podría surgir de un manejo inapropiado de los residuos.

Para mayor información sobre la recuperación y el reciclado de aparatos y baterías viejas, por favor, contacte con su comunidad local, su servicio de eliminación de residuos o al comercio donde adquirió estos aparatos.

Podrán aplicarse penas por la eliminación incorrecta de estos residuos, de acuerdo a la legislación nacional.



#### Para usuarios empresariales en la Unión Europea

Si usted desea desechar aparatos eléctricos y electrónicos, por favor contacte con su distribuidor o proveedor a fin de obtener mayor información.



#### [Información sobre la Eliminación en otros Países fuera de la Unión Europea]

Estos símbolos sólo son válidos dentro de la Unión Europea. Si desea desechar estos objetos, por favor contacte con sus autoridades locales o distribuidor y consulte por el método correcto de eliminación.

Nota sobre el símbolo de la batería (abajo, dos ejemplos de símbolos):

Este símbolo puede ser usado en combinación con un símbolo químico.

En este caso, el mismo cumple con los requerimientos establecidos por la Directiva para los productos químicos involucrados.

Italiano

### Informazioni per gli utenti sulla raccolta e l'eliminazione di vecchie apparecchiature e batterie usate



Questi simboli sui prodotti, sull'imballaggio, e/o sulle documentazioni o manuali accompagnanti i prodotti indicano che i prodotti elettrici, elettronici e le batterie usate non devono essere buttati nei rifiuti domestici generici.

Per un trattamento adeguato, recupero e riciclaggio di vecchi prodotti e batterie usate, vi preghiamo di portarli negli appositi punti di raccolta, secondo la legislazione vigente nel vostro Paese e le Direttive 2002/96/EC e 2006/66/EC.

Smaltendo correttamente questi prodotti e le batterie, contribuirete a salvare importanti risorse e ad evitare i potenziali effetti negativi sulla salute umana e sull'ambiente che altrimenti potrebbero verificarsi in seguito ad un trattamento inappropriato dei rifiuti.

Per ulteriori informazioni sulla raccolta e sul riciclaggio di vecchi prodotti e batterie, vi preghiamo di contattare il vostro comune, i vostri operatori per lo smaltimento dei rifiuti o il punto vendita dove avete acquistato gli articoli.

Sono previste e potrebbero essere applicate sanzioni qualora questi rifiuti non siano stati smaltiti in modo corretto ed in accordo con la legislazione nazionale.



#### Per utenti commerciali nell'Unione Europea

Se desiderate eliminare apparecchiature elettriche ed elettroniche, vi preghiamo di contattare il vostro commerciante od il fornitore per maggiori informazioni.



#### [Informazioni sullo smaltimento rifiuti in altri Paesi fuori dall'Unione Europea]

Questi simboli sono validi solo all'interno dell'Unione Europea. Se desiderate smaltire questi articoli, vi preghiamo di contattare le autorità locali od il rivenditore ed informarvi sulle modalità per un corretto smaltimento. Nota per il simbolo delle batterie (esempio con simbolo chimico riportato sotto il simbolo principale):

Questo simbolo può essere usato in combinazione con un simbolo chimico; in questo caso è conforme ai requisiti indicati dalla Direttiva per il prodotto chimico in questione.

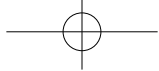

Português

## Informações para Utilizadores referentes à Recolha e Eliminação de Equipamentos Velhos e Baterias



Estes símbolos nos produtos, embalagens e documentos significam que os produtos eléctricos e electrónicos usados não podem ser misturados com os resíduos urbanos. Para o tratamento apropriado, recuperação e reciclagem de produtos velhos e baterias usadas, solicitamos que os coloque em pontos de recolha próprios, de acordo com a Legislação Nacional e com as Directivas Europeias 2002/96/ EC e 2006/66/EC. A eliminação correcta deste produto ajudará a poupar recursos valiosos e evitar quaisquer potenciais efeitos negativos na saúde humana e no ambiente, os quais poderiam resultar de um tratamento incorrecto de Resíduos. Para mais informações sobre a recolha e reciclagem de produtos velhos e baterias, por favor, contacte as autoridades locais responsáveis pela recolha de resíduos ou o ponto de venda onde o produto foi adquirido. De acordo com a legislação nacional, podem ser aplicadas multas caso seja feita a eliminação incorrecta destes resíduos.



### Para Utilizadores Não Particulares da União Europeia

Se pretender eliminar equipamentos eléctricos e electrónicos, por favor, contacte o seu Distribuidor ou Produtor para obter mais informações.



### [Informação sobre a eliminação noutros países fora da União Europeia]

Estes símbolos são válidos, apenas, na União Europeia. Se pretender eliminar este produto contacte, por favor, as autoridades locais responsáveis pela recolha de resíduos ou o ponto de venda onde o produto foi adquirido e solicite informação sobre o método de eliminação correcto.

Nota para os símbolos de baterias (dois exemplos de símbolos):

Este símbolo pode ser utilizado em conjugação com um símbolo químico.

Neste caso, terá de proceder em conformidade com o estabelecido na Directiva referente aos produtos químicos utilizados.

Български

## Информация за събиране и изхвърляне на стари електроуреди и батерии



Тези символи, поставени на продуктите, опаковките и/или съпътстващите ги документи обозначават електронни уреди, които не трябва да бъдат изхвърляни заедно с потока битови отпадъци. За да бъдат правилно третирани и рециклирани, моля да предадете тези продукти на специално предназначения за тази цел места, спазвайки разпоредбите на националното законодателство и европейските директиви 2002/96/EC и 2006/66/EC. Спазвайки инструкциите за правилното изхвърляне на такива уреди и батерии, вие ще помогнете да запазим ценни ресурси и да предотвратим възможни негативни ефекти върху човешкото здраве и околната среда. Моля, обърнете се към местните общински власти или търговския обект, откъдето сте закупили продукта, за да получите допълнителна информация за най-близкия събирателен пункт или място за изхвърляне на стари електроуреди и батерии. При неправилно изхвърляне на уреда, може да понесете наказателна отговорност, в съответствие с разпоредбите на националното законодателство.



### За бизнес потребители в Европейския Съюз

Ако желаете да изхвърлите ненужни електроуреди, моля свържете се с вашия дилър или доставчик за повече информация.



### [Информация за страни извън Европейския Съюз]

Тези символи са валидни само в рамките на Европейския Съюз. Ако желаете да се освободите от тези отпадъчни продукти, моля свържете се с местните органи на властта или вашия доставчик, за да получите информация за тяхното коректно изхвърляне.

Забележка за символите върху батерии (последните два символа в ляво):

Тези символи могат да бъдат използвани заедно с химически символ. В такъв случай те спазват изискванията определени от директива за съответния химикал.

Panasonic Corporation

Website: <http://panasonic.net/>

© Panasonic Corporation 2012.

Printed in China

Authorized representative in EU  
Panasonic Testing Centre  
Panasonic Marketing Europe GmbH  
Winsberg 15, 22525 Hamburg, Germany

F568946  
F1209-00