



## Multimedia Projector

EB-G6970WU

EB-G6770WU

EB-G6570WU

EB-G6470WU

EB-G6270W

EB-G6070W

EB-G6870

EB-G6370

EB-G6170

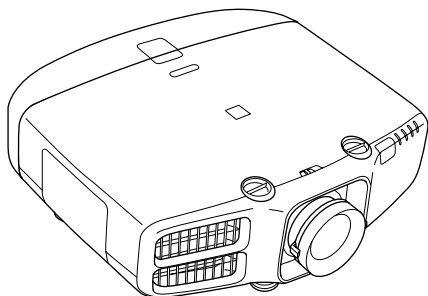

EN	Quick Reference	PL	Skrócona instrukcja obsługi
DE	Kurzübersicht	RO	Ghid informativ
FR	Référence rapide	EL	Γρήγορη αναφορά
IT	Riferimento rapido	TR	Hızlı Referans
ES	Referencia rápida	SL	Hitre informacije
PT	Referência Rápida	CA	Referència ràpida
NL	Beknopte handleiding	RU	Краткое руководство
DA	Lynvejledning	UK	Короткий довідник
FI	Pikaopas	KK	Қысқаша анықтама
NO	Hurtigreferanse	AR	مرجع سريع
SV	Snabbreferens	ZHS	快速参考
CS	Rychlá reference	ZHT	快速參考
HU	Gyors útmutató		

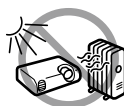

**EB-G6970WU/G6870**

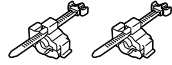
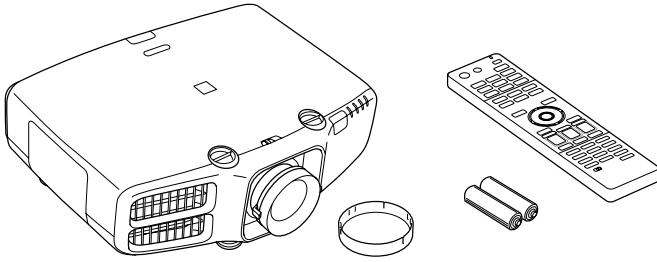

**EB-G6770WU/G6570WU/  
G6470WU/G6270W/  
G6070W/G6370/G6170**

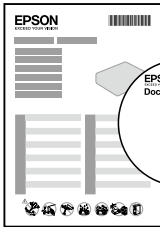
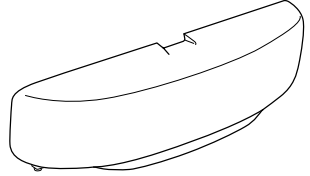
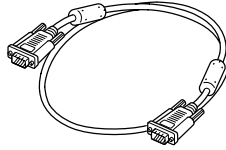
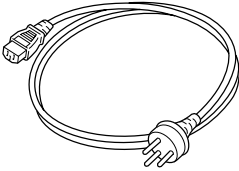

**EB-G6770WU/G6570WU/  
G6470WU/G6270W/  
G6070W/G6370/G6170**



**Except for NL model**

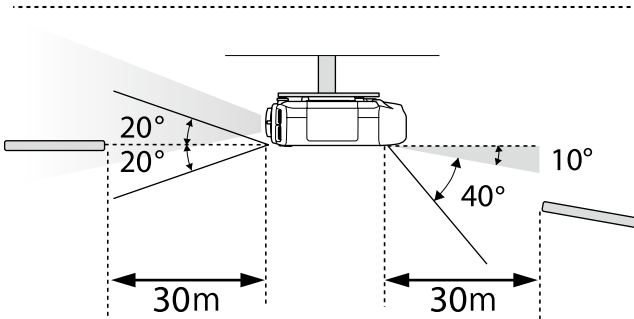
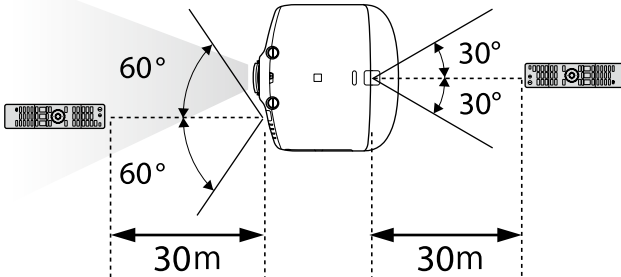
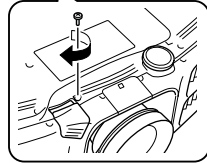

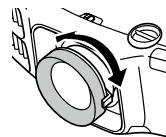
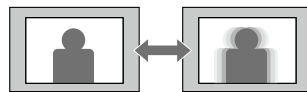
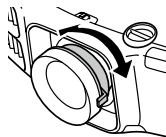
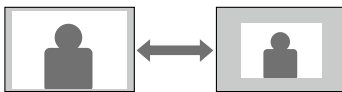
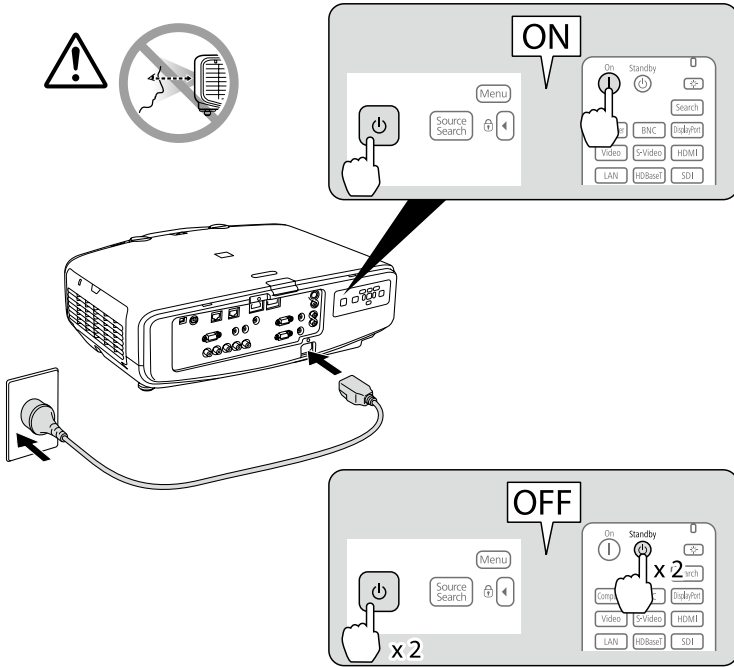
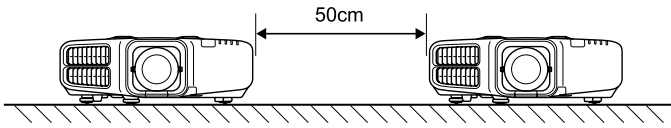
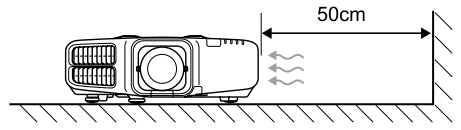
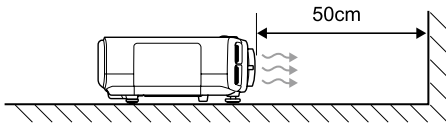

## Do you want to set the time?

Yes 

No

EN

When you turn on the projector for the first time, the message "Do you want to set the time?" is displayed. Select **Yes** and set Date/Time.  User's Guide  
If you set it later, select **No**.

DE

Wenn Sie den Projektor zum ersten Mal einschalten, wird die Meldung "Möchten Sie die Uhrzeit einstellen?" angezeigt. Wählen Sie **Ja** und stellen Sie Datum / Zeit ein.  Bedienungsanleitung  
Bei späterer Einstellung, wählen Sie **Nein**.

FR

Lorsque vous allumez le projecteur pour la première fois, le message "Voulez-vous régler l'heure ?" s'affiche. Sélectionnez **Oui** et définissez le paramètre Date/heure.  Guide de l'utilisateur  
Si vous souhaitez le définir ultérieurement, sélectionnez **Non**.

IT

Quando si accende il proiettore per la prima volta, viene visualizzato il messaggio "Si desidera impostare l'ora?". Selezionare **Si** e impostare Data/Ora.  Manuale dell'utente  
Se si imposta in seguito, selezionare **No**.

ES

La primera vez que encienda el proyector verá el mensaje "¿Desea ajustar la hora?". Seleccione **Sí** y configure la Fecha/Hora.  Manual de usuario  
Si prefiere configurarlas en otro momento, seleccione **No**.

PT

Quando ligar o videoprojector pela primeira vez, aparece a mensagem "Deseja ajustar a hora?". Seleccione **Sim** e defina a Data / Hora.  Manual do Utilizador  
Se a definir mais tarde, seleccione **Não**.

NL

De eerste keer dat u de projector inschakelt, wordt de melding "Tijd instellen?" weergegeven. Selecteer **Ja** en stel Datum/tijd in.  Gebruikershandleiding  
Selecteer **Nee** als u deze optie later wilt instellen.

DA

Når du tænder projektoren første gang, vises meddelelsen "Vil du indstille tiden?". Vælg **Ja**, og indstil Dato/klokkeslæt.  Brugervejledning  
Hvis du indstiller det senere, skal du vælge **Nej**.

FI

Kun kytket projektorin päälle ensimmäisen kerran, esiin tulee viesti "Haluatko asettaa ajan?". Valitse **Kyllä** ja aseta Pvm / Aika.  Käyttöopas  
Jos asetat sen myöhemmin, valitse **Ei**.

NO

Når du slår på projektoren for første gang, vises meldingen "Vil du stille klokken?" Velg **Ja**, og angi Dato/klokkeslett.  Brukerhåndbok  
Vil du angi dette senere, velger du **Nei**.

SV

Meddelandet "Vill du ställa in tiden?" visas när du slår på projektorn för första gången. Välj **Ja** och ställ in Datum/tid.  Bruksanvisning  
Välj **Nej** om du vill ställa in det senare.

CS

Při prvním spuštění projektoru se zobrazí zpráva "Chcete nastavit čas?". Vyberte možnost **Ano** a nastavte položku Datum / čas.  Uživatelská příručka  
Chcete-li provést toto nastavení později, vyberte možnost **Ne**.

HU	Amikor először kapcsolja be a kivetítőt, a "Be kívánja állítani az időt?" üzenet jelenik meg. Válassza az <b>Igen</b> lehetőséget és végezze el a Dátum / Idő beállítását.  Használati útmutató Ha később állítja be, válassza a <b>Nem</b> lehetőséget.
PL	Po pierwszym uruchomieniu projektora wyświetli się komunikat "Czy chcesz ustawić czas?". Wybierz przycisk <b>Tak</b> i ustaw opcję Data / czas.  Przewodnik użytkownika Aby ustawić ją później, wybierz przycisk <b>Nie</b> .
RO	În momentul în care porniți proiectorul pentru prima dată, pe ecran va fi afișat mesajul "Doriți să definiți ora?". Selectați <b>Da</b> și definiți Dată / Oră.  Ghidul utilizatorului Dacă le veți defini mai târziu, selectați <b>Nu</b> .
EL	Όταν ενεργοποιείτε για πρώτη φορά το βιντεοπροβολέα, εμφανίζεται το μήνυμα "Θέλετε να ρυθμίσετε την ώρα;". Επιλέξτε <b>Ναι</b> και ορίστε Ημερ./Ωρα.  Οδηγός χρήσης Για ορισμό αργότερα, επιλέξτε <b>Όχι</b> .
TR	Projektörünüz ilk kez açıldığında "Süreyi belirlemek istiyor musunuz?" mesajı görüntülenir. <b>Evet</b> öğesini seçin ve Tarih / Saat seçeneğini ayarlayın.  Kullanım Kılavuzu Daha sonra ayarlayacaksanız, <b>Hayır</b> öğesini seçin.
SL	Ko prvič vklopite projektor, se prikaže sporočilo "Ali želite nastaviti čas?". Izberite <b>Da</b> in nastavite Datum/čas.  Priročnik za uporabnika Če želite nastavitev opraviti kasneje, izberite <b>Ne</b> .
CA	Quan engegueu el projector per primera vegada, apareix el missatge "Voleu ajustar l'hora?". Seleccioneu <b>Sí</b> i ajusteu Data / Hora.  Guia de l'usuari Si ho voleu ajustar més tard, seleccioneu <b>No</b> .
RU	При первом включении проектора появляется сообщение "Хотите установить время?" Выберите <b>Да</b> и задайте параметр Дата / время.  Руководство пользователя Чтобы задать этот параметр позже, выберите <b>Нет</b> .
UK	Під час першого увімкнення проектора відображається повідомлення "Бажаєте встановити час?". Виберіть <b>Так</b> і встановіть параметр Дата/час.  Посібник користувача Якщо ви встановите його пізніше, виберіть <b>Ні</b> .
KK	Проекторды бірінші рет қосқанда "Do you want to set the time?" хабары көрсетіледі. <b>Yes</b> жауабын таңдап, күнді/уақытты орнатыңыз.  Пайдаланушы нұсқаулығы Оны кейінірек орнатсаңыз, <b>No</b> жауабын таңдаңыз.
AR	عندما تقوم بتشغيل جهاز العرض للمرة الأولى، يتم عرض الرسالة "هل ترغب في تعيين الوقت؟". حدد نعم واضبط التاريخ/الوقت.  دليل المستخدم إذا قمت بضبطه لاحقاً، حدد لا.
ZHS	首次打开投影机时，会显示消息 " 是否要设置时间？ "。选择 <b>是</b> 并设置日期 / 时间。  使用说明书 如果要在以后设置，请选择 <b>否</b> 。
ZHT	第一次開啟投影機時，會顯示 " 想設定時間嗎？ " 訊息。選擇 <b>是</b> 並設定日期 / 時間。  使用說明書 如果您稍後設定，請選擇 <b>否</b> 。

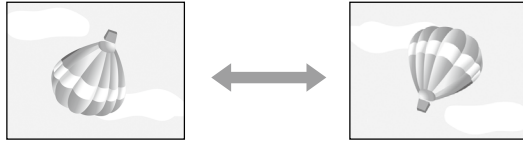

5 sec.

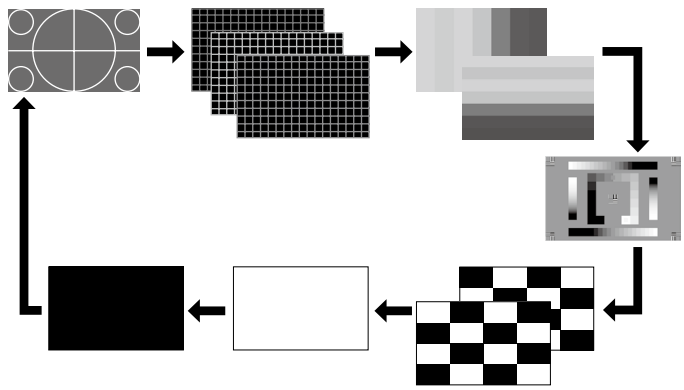
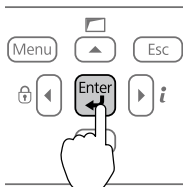
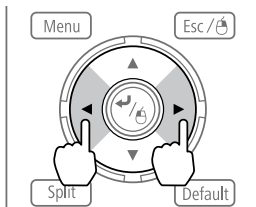
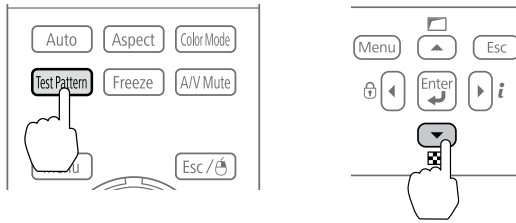
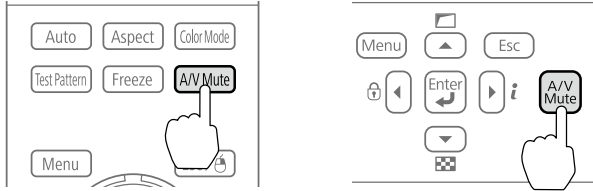

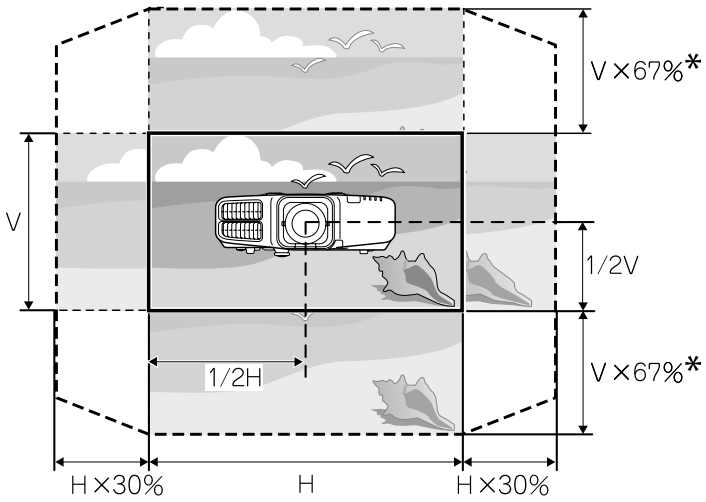
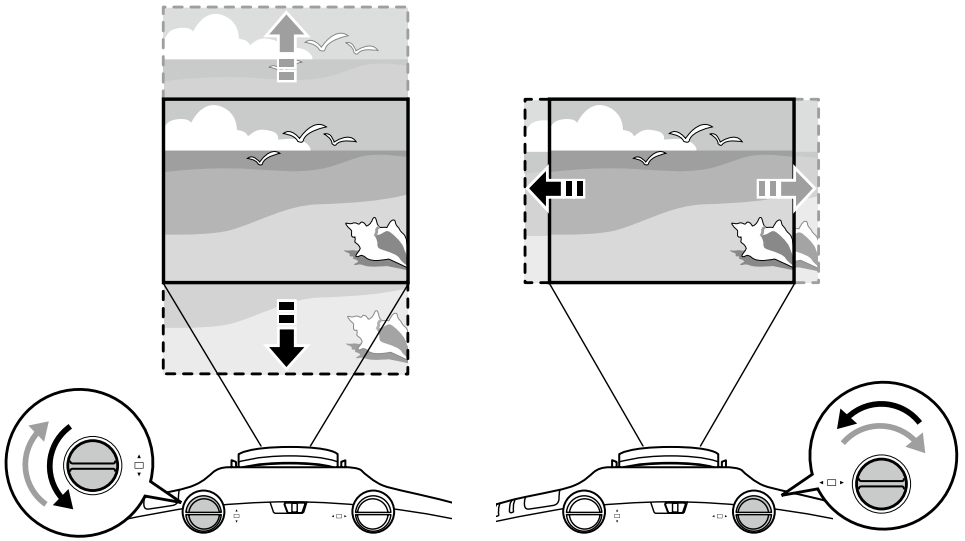

\*EB-G6870/G6370/G6170: 57%

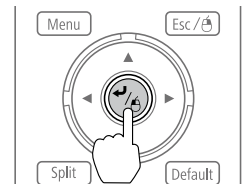
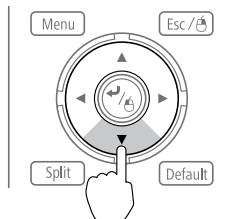
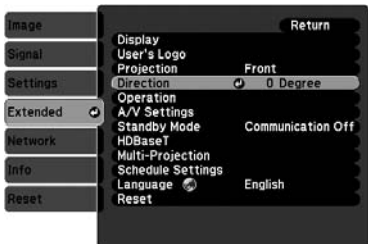
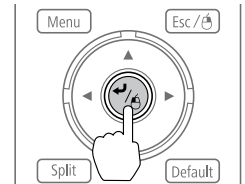
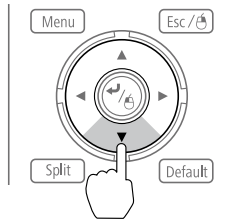
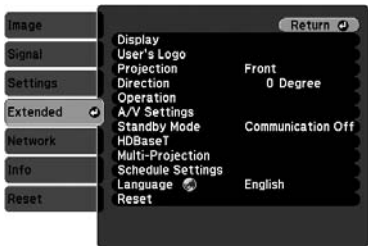
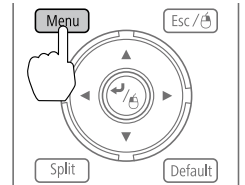
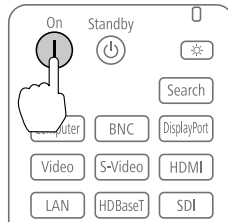
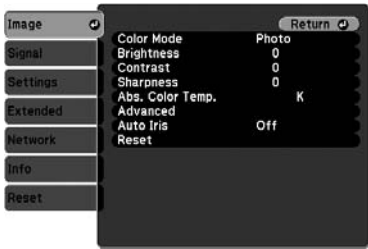
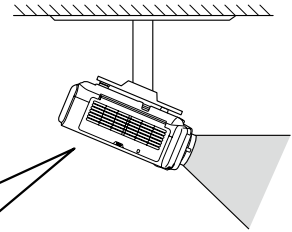
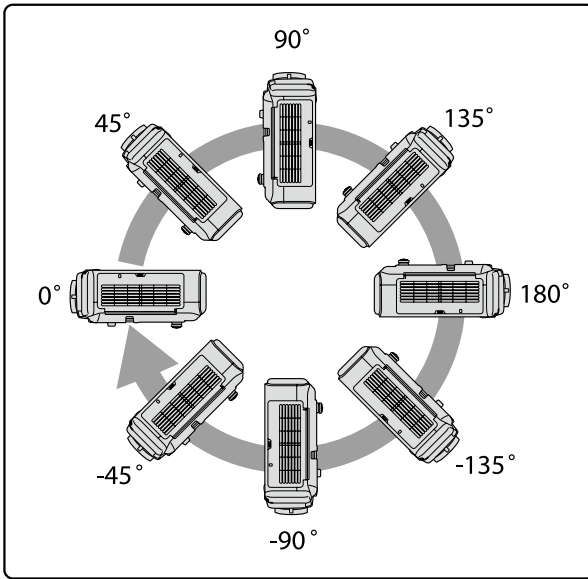



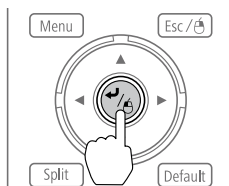
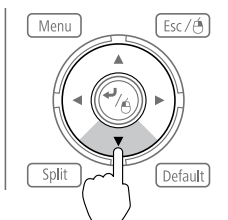
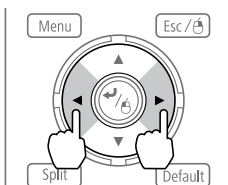
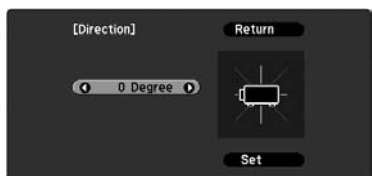

EN

When installation is complete, set the **Direction** from the configuration menu according to the vertical installation angle. Make sure you set **Direction** correctly. The lamp's operating life maybe reduced if it is not set.

DE

Wenn die Aufstellung abgeschlossen ist, stellen Sie die **Richtung** im Konfigurationsmenü entsprechend dem vertikalen Aufstellungswinkel ein. Achten Sie auf eine richtige Einstellung von **Richtung**. Die Lebensdauer der Lampe könnte sich sonst verringern.

FR

Une fois l'installation terminée, réglez l'option **Direction** du menu de configuration en fonction de l'angle d'installation vertical. Veuillez à définir correctement l'option **Direction**. Il est possible que la durée de fonctionnement de la lampe soit réduite si cette option n'est pas définie.

IT

Quando l'installazione è completata, impostare **Direzione** dal menu Configurazione in base all'angolo di installazione verticale. Assicurarsi di impostare **Direzione** correttamente. Se non impostata, la durata di funzionamento della lampada può risultare ridotta.

ES

Quando termine de instalarlo, ajuste la **Dirección** del menú de configuración según el ángulo de instalación vertical. Confirme que haya configurado la **Dirección** correcta, pues afecta a la vida útil de la lámpara.

PT

Quando a instalação estiver concluída, configure a **Direção** a partir do menu de configuração, de acordo com o ângulo de instalação vertical. Certifique-se de que define correctamente a **Direção**. O tempo de duração da lâmpada poderá diminuir caso esta não esteja definida.

NL

Na installatie stelt u **Richting** in het configuratiemenu in volgens de verticale installatiehoek. Stel **Richting** goed in. Als u dit niet goed instelt, kan de levensduur van de lamp worden verkort.

DA

Når installationen er udført, skal **Retning** indstilles i konfigurationsmenuen i henhold til den lodrette installationsvinkel. Kontroller, at **Retning** er indstillet korrekt. Lampens levetid kan blive reduceret, hvis den ikke er indstillet.

FI

Kun asennus on valmis, aseta **Suunta** konfigurointivalikosta pystysuunnan asennuskulman mukaisesti. Varmista, että asetat **Suunta**-asetuksen oikein. Lampun käyttöikä voi lyhentyä, jos sitä ei ole asetettu.

NO	Når monteringen er fullført, stiller du inn <b>Retning</b> på Konfigurasjonmenyen i henhold til den vertikale monteringsvinkelen. Pass på at du stiller inn <b>Retning</b> riktig. Lampens driftstid kan bli redusert hvis den ikke stilles inn.
SV	När installationen är klar ska du ställa in <b>Riktning</b> på konfigurationsmenyn beroende på den vertikala installationsvinkeln. Se till att <b>Riktning</b> ställs in på rätt sätt. Lampans livslängd kan förkortas om det inte ställs in.
CS	Po dokončení instalace nastavte položku <b>Orientace</b> v konfigurační nabídce podle úhlu svislé instalace. Položka <b>Orientace</b> musí být nastavena správně. V opačném případě se může zkrátit provozní životnost lampy.
HU	A telepítés végeztével állítsa be a konfigurációs menüben az <b>Írány</b> értéket a függőleges telepítési szög függvényében. Ügyeljen a megfelelő <b>Írány</b> beállítására. A lámpa élettartama csökkenhet, ha ez nincs beállítva.
PL	Po zakończeniu instalacji należy ustawić opcję <b>Kierunek</b> w menu konfiguracji zgodnie z kątem instalacji w pionie. Należy się upewnić, że opcja <b>Kierunek</b> jest ustawiona poprawnie. Nieustawienie tej opcji może skrócić żywotność lampy.
RO	Dacă instalarea s-a terminat, definiți valoarea pentru <b>Directie</b> din meniul de configurare în funcție de unghiul vertical de instalare. Asigurați-vă că introduceți corect valoarea pentru <b>Directie</b> . Durata de funcționare a lămpii se poate reduce dacă această valoare nu este definită.
EL	Όταν ολοκληρωθεί η εγκατάσταση, ορίστε την επιλογή <b>Κατεύθυνση</b> από το μενού διαμόρφωσης σύμφωνα με την κάθετη γωνία εγκατάστασης. Βεβαιωθείτε ότι έχετε ορίσει σωστά την επιλογή <b>Κατεύθυνση</b> . Αν δεν οριστεί, ενδέχεται να μειωθεί η διάρκεια ζωής της λάμπας.
TR	Kurulum tamamlandıktan sonra, dikey kurulum açısına göre yapılandırma menüsünden <b>Yön</b> ayarını yapın. <b>Yön</b> ayarını doğru yaptığınızdan emin olun. Doğru ayar yapılmadığında lambanın kullanım ömrü azalabilir.
SL	Po končani namestitvi nastavite možnost <b>Smer</b> v meniju za konfiguracijo glede na kot projektorja pri navpični namestitvi. Pazite, da boste za možnost <b>Smer</b> izbrali pravilne vrednosti. V nasprotnem primeru lahko skrajšate življenjsko dobo žarnice.
CA	Quan finalitzis la instal·lació, establiu la <b>Direcció</b> des del menú de configuració segons l'angle d'instal·lació vertical. Assegureu-vos d'establir la <b>Direcció</b> correctament. Si no ho feu, és possible que la vida útil de la làmpada es redueixi.
RU	По окончании установки задайте значение параметра меню настройки <b>Направление</b> в соответствии с углом вертикальной установки. Необходимо правильно задать параметр <b>Направление</b> . В противном случае может сократиться срок службы лампы.
UK	Після встановлення проєктора у меню конфігурації налаштуйте параметр <b>Напря́м</b> відповідно до кута вертикального встановлення. Переконайтеся, що параметр <b>Напря́м</b> налаштовано правильно. В іншому разі строк служби лампи може зменшитись.
KK	Орнату аяқталғанда тік орнату бұрышына сай теңшелім мәзірінен <b>Direction</b> параметрін орнатыңыз. <b>Direction</b> параметрін дұрыс орнатқаныңызды тексеріңіз. Ол орнатылмаса, шамның жұмыс мерзімі азаюы мүмкін.
AR	عندما يكتمل التركيب، اضبط الاتجاه من قائمة التهيئة تبعًا لزاوية التركيب الرأسية. تأكد من ضبط الاتجاه بشكل صحيح. قد يقل العمر التشغيلي للمصباح إذا لم يتم ضبطه.
ZHS	完成安装后，请根据垂直安装角度在配置菜单中设定 <b>方向</b> 。确保正确设定 <b>方向</b> 。如果未设定，灯泡的使用寿命可能会缩短。
ZHT	安裝完成後，請根據垂直安裝角度從配置選單中設定 <b>方向</b> 。請務必正確設定 <b>方向</b> 。如果未設定方向，燈泡的使用壽命可能會縮短。

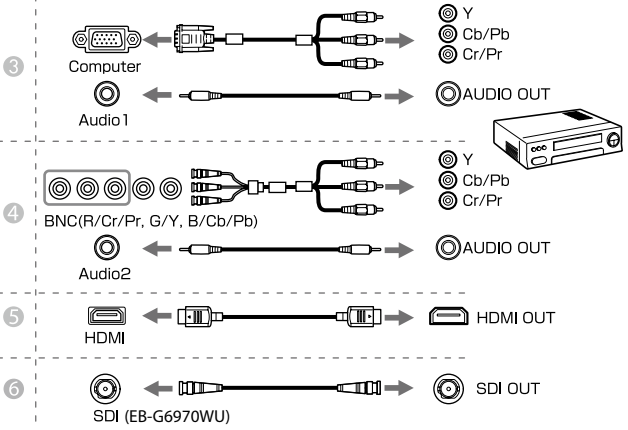
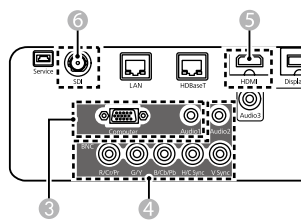
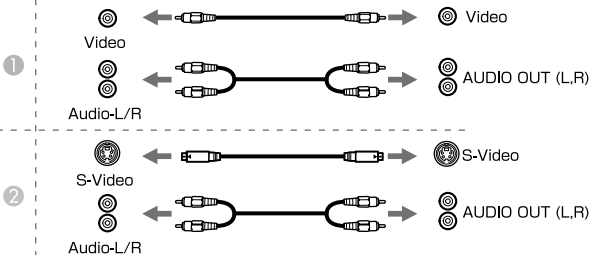
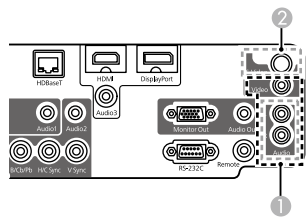
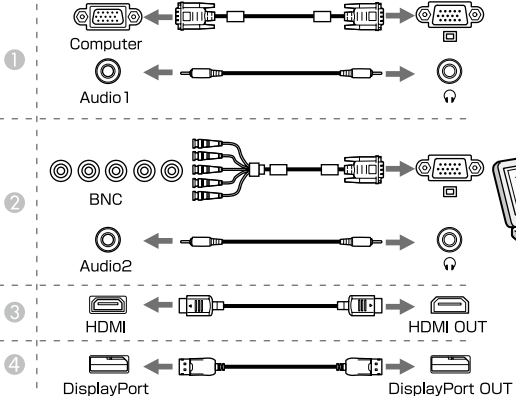
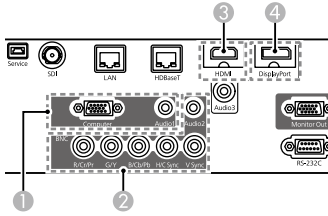

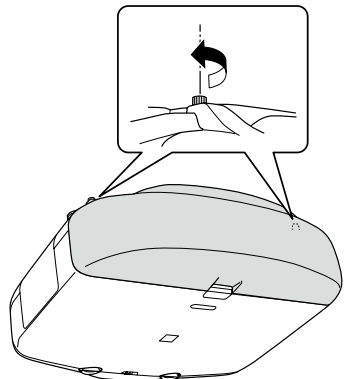
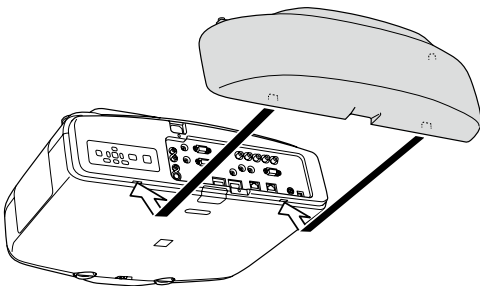
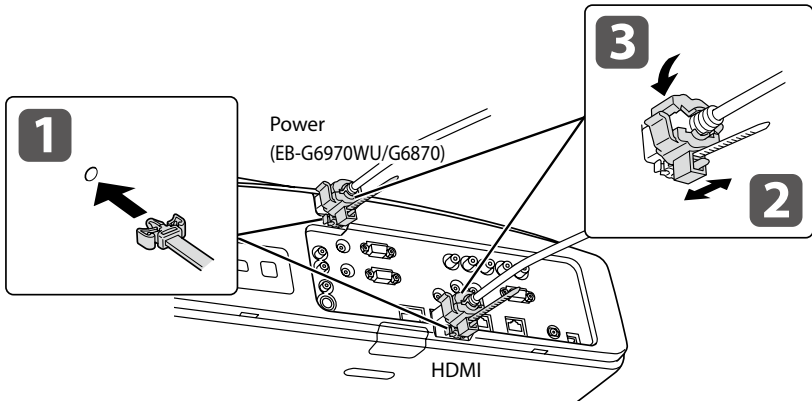
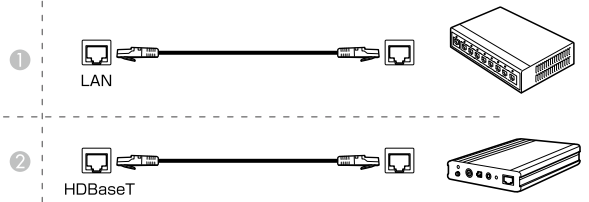
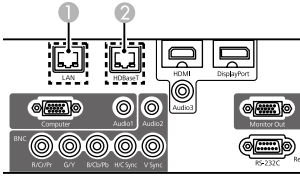
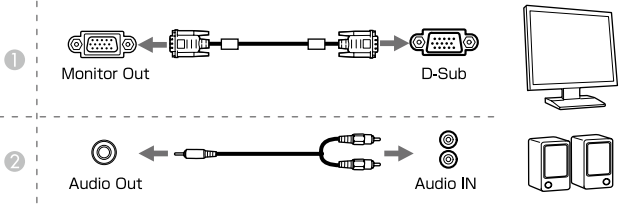
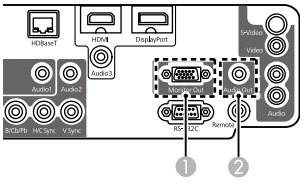

- **Lens Projection Distance Table**
- **Tabelle der Objektiv-Projektionsabstände**
- **Tableau des distances de projection**
- **Tabella delle distanze di proiezione dell'obiettivo**
- **Tabla de distancias de proyección según el objetivo**
- **Tabela de distância de projecção da lente**
- **Tabel met projectieafstanden van de lens**
- **Linseprojiceringsafstand**
- **Linssin projektioetäisyyden taulukosta**
- **Tabellen for linseprojiseringsavtand**
- **Avståndstabell för linsprojicering**
- **Tabulce vzdálenosti promítání objektivů**
- **Táblázat: Objektívek vetítési távolságai**
- **Tabeli odległości obiektywu od ekranu**
- **Tabelul cu distanțele de proiectie ale lentilelor**
- **Πίνακα απόστασης προβολής φακού**
- **Lens Projeksiyon Mesafesi Tablosunu**
- **Tabeli razdalj projekcije**
- **Taula de distàncies de projecció segons l'objectiu**
- **Таблице расстояний проецирования**
- **Таблиці відстаней проєкції об'єктива**
- **Объектив проекциясы қашықтықтарының кестесі**
- **جدول مسافة عرض العدسة**
- **镜头投影距离表**
- **鏡頭投影距離表**

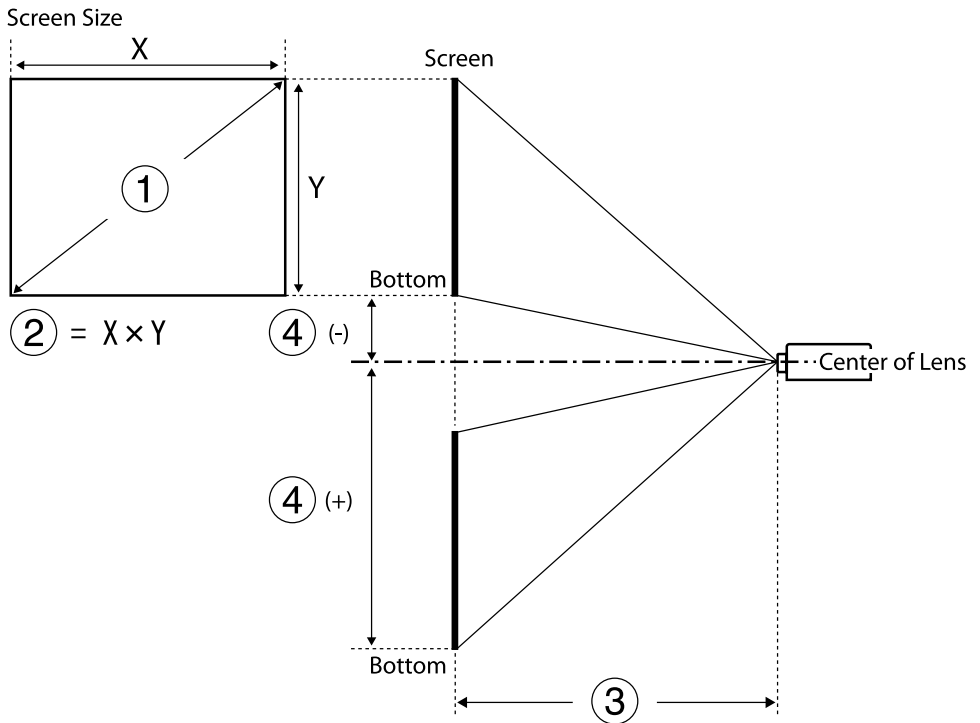

### EB-G6970WU/G6770WU/G6570WU/G6470WU/G6270W/G6070W

The lens shift function is not supported for ELPLR03.

16:10

cm

①	②	③						④
		Standard zoom lens ELPLS07	Short throw zoom lens ELPLU01	Rear projection wide lens ELPLR03	Middle throw zoom lens ELPLM04	Middle throw zoom lens ELPLM05	Long throw zoom lens ELPLL06	
50"	108x67	135 - 247	-	80	242 - 371	361 - 555	546 - 742	-12 - +79
60"	130x81	163 - 297	81 - 98	96	292 - 447	436 - 670	659 - 894	-14 - +95
80"	172x108	219 - 397	110 - 132	130	392 - 599	587 - 898	884 - 1198	-19 - +127
100"	215x135	275 - 498	139 - 167	163	493 - 751	738 - 1127	1110 - 1502	-24 - +158
150"	323x202	415 - 749	210 - 252	247	754 - 1131	1115 - 1699	1674 - 2263	-36 - +238
200"	431x269	555 - 1000	282 - 337	331	996 - 1512	1492 - 2270	2238 - 3023	-48 - +317
250"	538x337	695 - 1251	353 - 423	-	1248 - 1892	1869 - 2842	2802 - 3783	-59 - +396
300"	646x404	835 - 1501	425 - 508	-	1499 - 2272	2246 - 3414	3366 - 4544	-71 - +475

①	②	③						④
		Standard zoom lens ELPLS07	Short throw zoom lens ELPLU01	Rear projection wide lens ELPLR03	Middle throw zoom lens ELPLM04	Middle throw zoom lens ELPLM05	Long throw zoom lens ELPLL06	
50"	111x62	139 - 254	-	82	249 - 381	371 - 571	561 - 763	-16 - +78
60"	133x75	168 - 305	84 - 101	99	300 - 459	449 - 689	677 - 919	-19 - +94
80"	177x100	226 - 409	113 - 136	134	404 - 616	604 - 924	909 - 1232	-25 - +125
100"	221x125	283 - 512	143 - 171	168	507 - 772	759 - 1159	1141 - 1545	-31 - +156
150"	332x187	427 - 770	216 - 259	254	766 - 1163	1146 - 1746	1721 - 2326	-47 - +234
200"	443x249	571 - 1028	290 - 347	-	1024 - 1554	1534 - 2334	2301 - 3107	-63 - +312
250"	553x311	715 - 1285	363 - 434	-	1283 - 1945	1921 - 2921	2880 - 3889	-78 - +390
290"	642x361	830 - 1492	422 - 505	-	1490 - 2258	2231 - 3391	3344 - 4514	-91 - +452

4:3

cm

①	②	③						④
		Standard zoom lens ELPLS07	Short throw zoom lens ELPLU01	Rear projection wide lens ELPLR03	Middle throw zoom lens ELPLM04	Middle throw zoom lens ELPLM05	Long throw zoom lens ELPLL06	
50"	102x76	154 - 280	-	91	275 - 421	410 - 631	620 - 842	-13 - +90
60"	122x91	185 - 337	93 - 112	110	332 - 507	496 - 760	748 - 1015	-16 - +108
70"	142x107	217 - 394	109 - 131	129	389 - 593	581 - 890	876 - 1187	-19 - +126
80"	163x122	249 - 450	125 - 151	148	446 - 679	667 - 1019	1003 - 1359	-22 - +143
100"	203x152	312 - 564	158 - 189	186	560 - 851	837 - 1278	1259 - 1703	-27 - +179
150"	305x229	471 - 848	238 - 286	280	844 - 1282	1264 - 1925	1897 - 2564	-40 - +269
200"	406x305	629 - 1132	319 - 382	-	1129 - 1713	1691 - 2572	2536 - 3425	-54 - +359
250"	508x381	788 - 1416	400 - 479	-	1414 - 2143	2118 - 3219	3175 - 4285	-67 - +448

## EB-G6870/G6370/G6170

4:3

cm

①	②	③						④
		Standard zoom lens ELPLS07	Short throw zoom lens ELPLU01	Rear projection wide lens ELPLR03	Middle throw zoom lens ELPLM04	Middle throw zoom lens ELPLM05	Long throw zoom lens ELPLL06	
30"	61x46	76 - 141	-	44	-	-	-	-3 - +49
40"	81x61	103 - 189	-	60	184 - 283	274 - 424	416 - 568	-5 - +66
50"	102x76	130 - 238	-	76	232 - 357	347 - 535	525 - 714	-6 - +82
60"	122x91	157 - 286	78 - 95	92	281 - 430	419 - 645	634 - 861	-7 - +98
80"	163x122	211 - 383	105 - 127	125	378 - 577	565 - 865	851 - 1154	-9 - +131
100"	203x152	265 - 480	133 - 160	157	475 - 723	710 - 1086	1068 - 1447	-12 - +164
150"	305x229	400 - 722	201 - 242	237	717 - 1090	1073 - 1637	1612 - 2179	-17 - +246
200"	406x305	534 - 963	270 - 324	318	959 - 1456	1436 - 2188	2155 - 2912	-23 - +328
250"	508x381	669 - 1205	338 - 407	-	1202 - 1823	1799 - 2738	2699 - 3644	-29 - +410
300"	610x457	804 - 1447	407 - 489	-	1444 - 2190	2162 - 3289	3242 - 4376	-35 - +492

①	②	③						④
		Standard zoom lens ELPLS07	Short throw zoom lens ELPLU01	Rear projection wide lens ELPLR03	Middle throw zoom lens ELPLM04	Middle throw zoom lens ELPLM05	Long throw zoom lens ELPLL06	
28"	62x35	77 - 144	-	45	-	-	-	-9 - +44
30"	66x37	83 - 154	-	48	-	-	-	-10 - +47
37"	82x46	-	-	-	184 - 283	274 - 424	416 - 568	-12 - +58
40"	89x50	113 - 207	-	66	201 - 310	300 - 464	455 - 620	-13 - +63
50"	111x62	142 - 259	-	83	254 - 390	379 - 584	574 - 780	-17 - +79
60"	133x75	171 - 312	85 - 103	101	307 - 469	458 - 704	692 - 939	-20 - +95
80"	177x100	230 - 418	115 - 139	136	412 - 629	617 - 944	929 - 1259	-27 - +126
100"	221x125	289 - 523	145 - 175	171	518 - 789	775 - 1184	1166 - 1578	-33 - +158
150"	332x187	436 - 786	220 - 264	259	782 - 1188	1170 - 1784	1758 - 2376	-50 - +237
184"	407x229	-	-	318	-	-	-	+114
200"	443x249	583 - 1050	294 - 354	-	1046 - 1588	1566 - 2385	2350 - 3174	-67 - +316
250"	553x311	729 - 1313	369 - 443	-	1310 - 1987	1962 - 2985	2942 - 3972	-83 - +395
275"	609x342	803 - 1445	407 - 489	-	1444 - 2189	2162 - 3289	3242 - 4376	-92 - +434

①	②	③						④
		Standard zoom lens ELPLS07	Short throw zoom lens ELPLU01	Rear projection wide lens ELPLR03	Middle throw zoom lens ELPLM04	Middle throw zoom lens ELPLM05	Long throw zoom lens ELPLL06	
29"	62x39	78 - 145	-	45	-	-	-	-7 - +47
30"	65x40	81 - 150	-	47	-	-	-	-8 - +48
38"	82x51	-	-	-	184 - 284	274 - 424	416 - 568	-10 - +61
50"	108x67	138 - 252	-	81	247 - 379	368 - 568	558 - 758	-13 - +80
60"	130x81	167 - 304	83 - 101	98	298 - 456	445 - 685	673 - 913	-15 - +96
70"	151x94	195 - 355	97 - 118	115	350 - 534	522 - 801	788 - 1069	-18 - +112
80"	172x108	224 - 406	112 - 135	132	401 - 612	599 - 918	903 - 1224	-21 - +128
100"	215x135	281 - 509	141 - 170	166	504 - 767	753 - 1152	1134 - 1535	-26 - +160
150"	323x202	424 - 765	214 - 257	252	761 - 1156	1138 - 1736	1710 - 2311	-39 - +241
189"	407x254	-	-	318	-	-	-	+127
200"	431x269	567 - 1021	286 - 344	-	1017 - 1544	1523 - 2320	2286 - 3087	-51 - +321
250"	538x337	710 - 1278	359 - 431	-	1274 - 1933	1908 - 2904	2862 - 3864	-64 - +401
280"	603x377	795 - 1432	-	-	-	-	-	-72 - +449
283"	610x381	-	407 - 489	-	1444 - 2189	2162 - 3289	3242 - 4376	-73 - +454



- Supported Resolutions
- Unterstützte Bildschirmauflösungen
- Résolutions prises en charge
- Risoluzioni Supportate
- Resoluciones compatibles
- Resoluções suportadas
- Ondersteunde Resoluties
- Understøttede opløsninger
- Tuetut kuvatarkkuudet
- Støttede oppløsninger
- Upplösningar som stöds
- Podporovaná Rozlišení
- Támogatott Felbontások
- Obsługiwane Rozdzielczości
- Rezoluții Acceptate
- Υποστηριζόμενοι τύποι ανάλυσης
- Desteklenen Çözünürlükler
- Podprte Ločljivosti
- Resolucions compatibles
- Поддерживаемые разрешения экрана
- Підтримувані значення роздільної здатності
- Қолдау көрсетілетін ажыратымдылықтар
- مستويات الدقة المدعومة
- 支持的分辨率
- 可支援的解析度

## Computer signals (analog RGB)

Signal	Refresh Rate (Hz)	Resolution (Dots)
VGA	60/72/75/85	640x480
SVGA	56/60/72/75/85	800x600
XGA	60/70/75/85	1024x768
WXGA	60	1280x768
	60	1366x768
	60/75/85	1280x800
WXGA+	60/75/85	1440x900
WXGA++	60	1600x900
SXGA	70/75/85	1152x864
	60/75/85	1280x1024
	60/75/85	1280x960
SXGA+	60/75	1400x1050
WSXGA+* <sup>1</sup>	60	1680x1050
UXGA	60	1600x1200
WUXGA* <sup>2</sup>	60	1920x1200
MAC13"	67	640x480
MAC16"	75	832x624
MAC19"	75	1024x768
	59	1024x768
MAC21"	75	1152x870

\*1 Only compatible when **Wide** is selected as the **Resolution** from the Configuration menu. (This is not available for EB-G6870/G6370/G6170.)

\*2 EB-G6970WU/G6770WU/G6570WU/G6470WU only.  
Only compatible when VESA CVT-RB (Reduced Blanking) signal is input.

## Component Video

Signal	Refresh Rate (Hz)	Resolution (Dots)
SDTV (480i)	60	720x480
SDTV (576i)	50	720x576
SDTV (480p)	60	720x480
SDTV (576p)	50	720x576
HDTV (720p)	50/60	1280x720
HDTV (1080i)	50/60	1920x1080
HDTV (1080p)*	50/60	1920x1080

\* When using EB-G6270W/G6070W/G6870/G6370/G6170, only for the input signals from the Computer port.

## Composite Video

Signal	Refresh Rate (Hz)	Resolution (Dots)
TV (NTSC)	60	720x480
TV (SECAM)	50	720x576
TV (PAL)	50/60	720x576

## HDMI/DisplayPort/HDBaseT\*<sup>1</sup>

Signal	Refresh Rate (Hz)	Resolution (Dots)
VGA	60	640x480
SVGA	60	800x600
XGA	60	1024x768
WXGA	60	1280x800
	60	1280x768* <sup>2</sup>
	60	1366x768
WXGA+	60	1440x900
WXGA++	60	1600x900
WSXGA+* <sup>3</sup>	60	1680x1050
SXGA	60	1280x960
	60	1280x1024
SXGA+	60	1400x1050
UXGA	60	1600x1200
WUXGA* <sup>4</sup>	60	1920x1200
SDTV (480i* <sup>5</sup> /480p)	60	720x480
SDTV (576i* <sup>5</sup> /576p)	50	720x576
HDTV (720p)	50/60	1280x720
HDTV (1080i)	50/60	1920x1080
HDTV (1080p)	24* <sup>5</sup> /30* <sup>5</sup> /50/60	1920x1080

\*1 When an HDMI connection is made using the optional HDBaseT Transmitter.

\*2 DisplayPort input only

\*3 This is not available for EB-G6870/G6370/G6170.

\*4 Only compatible when VESA CVT-RB (Reduced Blanking) signal is input. For EB-G6270W/G6070W/G6870/G6370/G6170, HDMI input only.

\*5 HDMI input only.

## SDI (EB-G6970WU)

Signal	Refresh Rate (Hz)	Resolution (Dots)
SDTV (480i)	60	720x480
SDTV (576i)	50	720x576
HDTV (720p)	50/60	1280x720
HDTV (1080i)	50/60	1920x1080
HDTV (1080p)	24/25/30	1920x1080

Unit : mm

