

REMINGTON®

How to get a great shave from your Remington® MicroScreen® 3 Shaver

Thank you for buying this premium shaver from Remington®.

Inside you'll find tips on using and caring for your shaver to get the best shave possible.

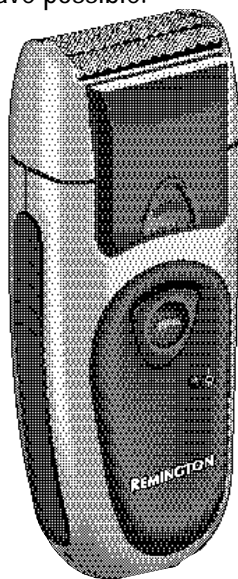

IMPORTANT SAFETY INSTRUCTIONS

When using an electric shaver, basic precautions should always be observed, including the following. Read all instructions before using this shaver.

DANGER

To reduce the risk of electric shock:

- Do not reach for a shaver that has fallen into water. Unplug immediately.
- Do not use while bathing or in a shower.
- Do not place or store shaver where it can fall or be pulled into a tub or sink. Do not place in or drop into water or other liquid.
- Except when charging, always unplug this shaver from the electrical outlet immediately after using.
- Unplug this shaver before cleaning.

WARNING

To reduce the risk of burns, fire, electric shock, or injury to persons:

- A shaver should never be left unattended when plugged in, except when charging your rechargeable shaver.
- Close supervision is necessary when this shaver is used by, on, or near children or invalids.

- Use this shaver only for its intended use as described in this manual. Do not use attachments not recommended by the manufacturer.
- Keep the cord away from heated surfaces.
- Never operate this shaver if it has a damaged cord or if it is not working properly, if it has been dropped or damaged, or dropped into water. Return the shaver to a service center for examination and repair.
- Never drop or insert any object into any opening.
- Do not use outdoors or operate where aerosol (spray) products are being used or where oxygen is being administered.
- Do not use this shaver with a damaged or broken cutter or head, as facial injury may occur.
- Always attach plug to shaver, then to outlet. To disconnect, turn all controls to "Off," then remove plug from outlet, then detach power cord from the shaver for storage.
- Always store your shaver and cord in a moisture-free area. Make sure your cord is disconnected from the shaver.
- "Household Use Only".

SAVE THESE INSTRUCTIONS

Getting a Close, Comfortable Shave

Congratulations on your purchase of a premium Remington® MicroScreen® 3 Shaver. Your Remington® MicroScreen® 3 Shaver is a wise investment for men who are concerned with looking well-groomed. It will give you years and years of close, comfortable shaves. As with every shaver, your shave will improve over time. So allow about three weeks to develop an effective shaving style and for your beard to adjust to the new shaver. The adaptation period may take a little longer if your skin is sensitive, if you are switching from a different way of shaving, or if you alternate between shaving methods.

When you first removed your MicroScreen® 3 Shaver from its box, you may have noticed what appear to be small particles of white or gray powder on the MicroScreen or in or around the cutter assembly. The particles are from a coating of a special lubricant applied to the new foil and cutters to smooth breaking in your new shaver. They will disappear with use.

The Best Technique

It's simple to get a great shave out of your new shaver. Your MicroScreen® 3 Shaver is designed to do all the work. The first foil sets up the beard so that more hairs enter the cutting chamber of the second foil where they are cut just below the level of the skin. The third foil helps give you an extra-close shave. Here are a few tips for getting the closest shave possible:



Always use a clean, dry shaver.



Wait at least 15 minutes after rising to allow the puffiness that most men experience upon waking to disappear.



Make sure your face is clean and dry before starting.



Hold the shaver so all three foils touch your face together. This allows the shaver to work the way it was designed for the closest shave and minimum foil wear. Avoid holding the shaver at an angle so only one foil touches the skin. This will distort the foil and may cause some skin irritation.

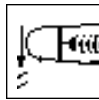

Use short, circular strokes.

Use your free hand to stretch your skin. This encourages your whiskers to stand out, making it easier for them to enter the cutting mechanism.



Never press hard. Pressing only flattens your whiskers, which makes it harder for them to enter the cutting mechanism. It will also wear out the foils more quickly.

Shaving Longer Hairs



Your Remington® MicroScreen® 3 Shaver is equipped with a special push-up trimmer that allows you to shave stubborn long hairs on facial and neck areas or trim a beard or mustache quickly and easily. Just push the trimmer button upward until the trimmer locks into position.



Stroke the hairs being trimmed lightly. To extend battery life, turn off the trimmer while you are shaving.

For a Better Shave...

To help maximize your shaver's performance, consider using the Remington® Pre-Shave Powder Stick (SP-5). Just rub it over your beard. It absorbs moisture and facial oils, helping set up the hairs so they enter the cutting chamber more easily. It makes shaving quicker and more comfortable.

Cleaning Your Shaver

TO ASSURE SMOOTH, EFFICIENT PERFORMANCE, IT IS IMPORTANT TO CLEAN YOUR SHAVER. Cleaning your Remington® MicroScreen® 3 Shaver is easy.

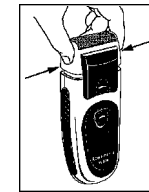

- Remove the head assembly by holding onto the sides of the head assembly at the arrows and gently lifting the assembly away from the shaver.

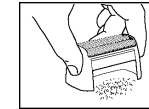

- Tap the base of the head assembly lightly on a flat surface. This should dislodge most of the hairs trapped within it. To guard against inadvertent damage, do not remove the foil assembly, except to replace it.

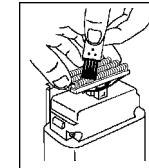

- Next, clean the cutter assembly while it is still on the shaver. Hold the shaver and cutter assembly as shown, and, using shorter bristles on the brush supplied, lightly brush and blow the hair clippings from between the blades.

Tip: To help reduce wear and tear, spray the foils and head assembly with Remington® Spray Shaver-Saver® Lubricant after every shave. This helps remove hairs while keeping your shaver operating smoothly.

Trimmer Care

The trimmer on your Remington® MicroScreen® 3 Shaver is easy to maintain.

- When you clean your shaver, just brush off any clippings that may accumulate around the trimmer Assembly. Using the longer bristles on the brush supplied will enable you to get into the area between the trimmer and the shaver.

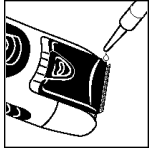

- Every six months, lubricate the trimmer teeth by applying a drop of light machine oil one-third and two-thirds of the way along the blade. Using your finger tip, spread the oil along the teeth, and run the trimmer for a few seconds.

Replacing Foils and Cutters

Because they are subject to daily use, the cutters and foils of your Remington® MicroScreen® 3 Shaver will wear and eventually require replacement to maintain a close, comfortable shave. Depending on your shaving technique and habits, the foils will usually last six months; the cutters, one year. Some signs that your foils and cutters need replacing are:

- Irritation. As foils get worn, you may notice your skin feeling more sensitive after a shave, particularly when you apply after-shave.
- Pulling. As cutters wear, your shave may not feel as close, and you may feel your shaver is pulling at your whiskers.
- Wear-through. You may notice that the cutters have worn through the foil.

To prevent inadvertent damage to the Foils and Cutter Assembly, do not attempt to remove them unless you are replacing them. To remove the old foil and cutters follow the instructions that come with the foil and cutter replacement package. It's always a good idea to replace the foils when you replace the Cutter Assembly.

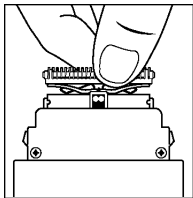

To Replace a Cutter Assembly That is Removed Unintentionally:

- Hold the assembly in the middle of the "T."
- Gently place the forked legs into the opening at the top of the oscillator tips.
- Do not push downward on the ends of the cutters, as you may bend the cutter, reducing its ability to operate smoothly.
- Do not remove cutters from the plastic pieces to which they are attached, as you may damage the assembly.

Operating Your Shaver

Removing the Headguard

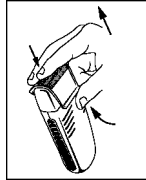

Before operating your MicroScreen® 3 Shaver, remove the headguard, which protects the foils and cutter assembly. It is important to remove the headguard correctly to avoid damaging the clips that hold it firmly to the shaver.

- Press lightly on the top of the headguard.
- Lift the lower rear edge.
- Pull the headguard away from the shaver.

Cordless Operation

The TA-3070/4570/5570 shavers are designed for cordless operation and can be recharged easily. For cordless operation, just press the locking bar in the center of the On/Off button and push the button toward the head of the shaver.

Charging

Prior to using your shaver for the first time, put it on charge for 24 hours. To charge your shaver:

- Slide the On/Off button to the "Off" position.
- Connect the cord to the shaver and then to the electric outlet. The charging indicator light will glow green, indicating your shaver is charging.
- The TA-4570 charging indicator will begin to flash slowly as the shaver reaches full charge.
- Your shaver cannot be overcharged, so you can leave it plugged in and charging between shaves.
- Use only the cord supplied with shaver. The TA-3070 is designed for cordless operation only. Plugging in the cord will not provide the power to shave.
- The TA-4570/5570 on the other hand, comes with a special feature that allows you to shave while your shaver is being recharged. Just follow the steps above to plug in the cord. Turn on the shaver by pressing on the locking bar and sliding the On/Off button upward. Your shaver will not recharge while you are shaving, so after shaving, leave it plugged in so it can be recharged.
- The TA-4570/5570 will provide a week's worth of shaving after a one hour charge or a single shave after five minutes of charging.

Charging: GREEN LED appears when shaver is plugged in and charging.

Cordless: When the shaver is operating from the battery in a fully charged state, the LED will appear GREEN. The LED will gradually change to AMBER as the battery is depleted. When approximately two shaves remain, the LED will change from AMBER to RED.

Troubleshooting

- If your TA-4570/5570 shaver battery is completely discharged or the shaver has not been used for an extended period of time, the shaver may not start when operated using the cord. If this condition occurs, charge the shaver for approximately five minutes before shaving.
- Your TA-4570/5570 cord/cordless shaver should not be used strictly as a cord-operated shaver, as continued cord only use will result in reduction of battery life.
- In order to preserve the life of the batteries, they should be fully discharged every six months and then fully charged for 24 hours.

Dual Voltage

You can take your MicroScreen® 3 shaver with you when you travel just about anywhere in the world. your MicroScreen® 3 shaver features worldwide automatic dual voltage conversion providing AC current between 100-240 volts, 50-60 Hz. Just plug it in to the local outlet (you may need an adapter plug) and use as usual. Your shaver will convert automatically to the local current requirements.

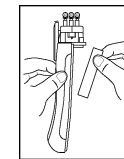
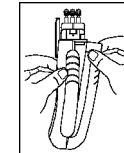
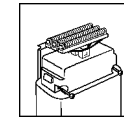

The following procedures should be followed for battery removal:

- Make sure your shaver is unplugged from any outlets, so you don't risk an electrical shock.
- Remove the head assembly by gently lifting the assembly away from the shaver.
- Using a small Phillips head screwdriver, remove the four screws from the upper and lower back of the shaver.
- Pull or gently pry the shaver halves apart, exposing the battery.
- Lift the rubber Side Panels from their cradles and put them aside.
- Hold each battery in place and very carefully slide the clips from the terminals on each battery.
- Lift or pry the battery out of the shaver.

CAUTION: THESE NICKEL-CADMIUM BATTERIES MUST BE RECYCLED OR DISPOSED IN ACCORDANCE WITH STATE AND LOCAL REGULATIONS. Do not burn or mutilate, as they may burst or release toxic materials. Do not short-circuit, as it may cause burns.



Battery Removal

The EPA certified RBRC[®] Battery Recycling Seal on the nickel-cadmium (Ni-Cd) battery indicates Remington is voluntarily participating in an industry program to collect and recycle these batteries at the end of their useful life, when taken out of service in the United States or Canada. The RBRC[®] program provides a convenient alternative to placing used Ni-Cd batteries into the trash or the municipal waste stream, which may be illegal in your area. Please call 1-800-8-BATTERY[™] for information on Ni-Cd battery recycling and disposal bans/restriction in your area. Remington involvement in this program is part of our commitment to preserving our environment and conserving our natural resources.*

TA Shaver Parts

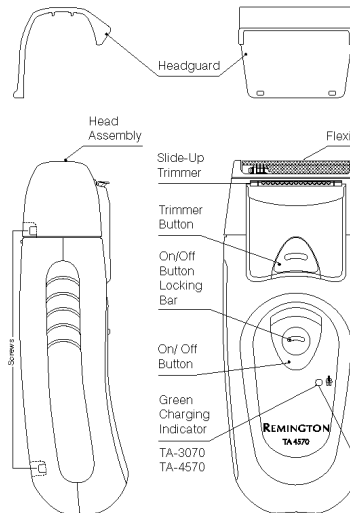

Remington MicroScreen[®] 3 Models

Which model is yours?	
TA-3070	Cordless, rechargeable operation with charging indicator light. Dual voltage 105-130 volts, AC 60 Hz, 105-240 volts, AC 50 Hz.
TA-4570	Cord and cordless, rechargeable operation with charging indicator light and quick 5 minute and 1-hour charging. Dual voltage 100-240 volts, AC 50-60 Hz.
TA-5570	Cord and cordless, rechargeable operation with ColorView [™] Power indicator. Quick 5 minute and one-hour charging features. Dual voltage 100-240 volts, AC 50-60 Hz.

Performance Guarantee

Remington[®] Money-Back Offer

You have just bought one of the finest shavers available today. If for any reason within 30 days from when you purchased your Remington[®] MicroScreen[®] 3 Shaver, you are not satisfied with your shaver and would like a refund, just return your shaver, together with the sales receipt, to the retailer from whom you purchased it. Remington will reimburse all retailers who accept shavers within 30 days of purchase. If you have any questions regarding this money-back guarantee, please call 1-800-736-4648.

Full One-Year Warranty

Remington warrants that your product, except as noted below, is, on date of purchase, free from defect in material and workmanship. Remington will correct any such defect without charge if you return the complete product either in person or by mail, postage paid, to a Remington Company-owned Service Center or Authorized Service Dealer within one year after date of purchase.

Do not return the product to the retailer from whom the product was purchased.

This warranty does not cover damage by accident, misuse, abuse or by affixing an unauthorized accessory or alteration to the product, or by connection of the product to any but the specific current and voltage indicated in an accompanying instruction booklet, or by any other conditions beyond our control. REMINGTON SHALL NOT BE RESPONSIBLE FOR ANY INCIDENTAL, SPECIAL OR CONSEQUENTIAL DAMAGES.

IN ADDITION, THIS WARRANTY DOES NOT COVER THE FLEXIBLE SCREEN ASSEMBLY ON OUR FOIL TYPE SHAVERS.

ALL IMPLIED WARRANTIES INCLUDING BUT NOT LIMITED TO IMPLIED WARRANTIES OF FITNESS AND MERCHANTABILITY, ARE LIMITED IN DURATION TO ONE YEAR FROM DATE OF ORIGINAL PURCHASE.

This warranty gives you specific legal rights, and you may also have other rights that vary from state to state. Some states do not allow the exclusion limitation of incidental or consequential damages or limitations on how long an implied warranty lasts, so that the above limitations and exclusions may not apply to you.

No responsibility, obligation, or liability is assumed for the installation or maintenance of this product.

Warranty Service

Warranty service must be performed by a Remington Company-owned Service Center or Authorized Service Dealer and damage or loss of any kind resulting from servicing by any other person is not covered under warranty. Enclosed is a listing of Company-owned Service Centers. Authorized Service Center Dealers may be found in the yellow pages of your directory. If you wish, you may mail the product, postpaid, to Remington Products Company L.L.C., 60 Main Street, Bridgeport, CT 06604 Attention:Service Department.

U.S. Warranty Service

In the United States, service is provided by our Company-owned Service Centers and over 300 Authorized Service Dealers. The addresses of our Company-owned Service Centers are enclosed. For the address of your nearest Authorized Service Dealer, please consult the Yellow Pages under "Shaver - Electric - Repair." If you wish, you may mail the product, postpaid, to Remington Products Company L.L.C., 60 Main Street, Bridgeport, CT 06604, Attention: Service Department.

International Warranty Service

Service under the Remington warranty can be obtained outside the United States by Remington-Authorized Distributors and Service Dealers. Please consult your local telephone directory for the nearest location.

For questions or comments, please write:
Remington Products Company, L.L.C.
P.O. Box 1536,
Horsham, PA 19044-6536
Attention: Consumer Affairs



Questions or Comments: Please call 1-800-736-4648.



Visit us at <http://www.remington-products.com>

REMINGTON
PRODUCTS COMPANY, L.L.C.
60 Main Street Bridgeport, CT 06604

Remington, MicroScreen and
ShaverSaver are trademarks of
Remington Corporation,L.L.C.
© 1998 RPC, L.L.C. Rev 8/98
Part No. 12640