

MANUFACTURER'S STATEMENT

Read this Operation Manual carefully before use, to ensure proper operation of this sensor.
Failure to read this Operation Manual may cause improper sensor operation and may result in serious injury or death.
This product is a non-contact activating switch intended for mounting on the header of an automatic door.
Do not use it for any other applications; otherwise proper operation and safety cannot be guaranteed.

Cautions:

1. Follow the instructions (especially **Note**) in this Operation Manual when installing and adjusting the sensor.
2. When setting the sensor's area pattern, make sure there is no traffic around the installation site.
3. Before turning the power on, check the wiring to prevent damage or malfunction of equipment that is connected to the sensor.
4. Do not wash, disassemble, rebuild or repair the sensor by yourself; otherwise it may cause electric shock or breakdown of the sensor.
5. Only use the sensor as specified in the supplied instructions.
6. Be sure to install the sensor in accordance with the local laws and standards of your country.
7. Before leaving the jobsite, be sure that this sensor is operating properly and instruct the building owner/operator on proper operation of the door and this sensor.

SPECIFICATIONS

Model : **MR8003**
Cover color type : Silver
Mounting Height : 3.0m (9'10") Max.
Detection Area : See "Detection Area"
Detection Method : Active Infrared Reflection Method
Detection Angle : $\pm 4^\circ$ adjustable by 1° every one click
Adjustments (Deep / Shallow)
Detection Width : $\pm 7^\circ$ adjustable by 3.5° every one click
Adjustments (Right / Left)
Power Supply : 12 to 30V AC / DC
Current Draw : 160mA Max. (at 12V AC)
Operation Indicator: Green / Stand-by
Red / 1st Row Detection Active
Orange / Other Row Detection Active

Output : "Form C" relay 50V 0.3A Max.
(Resistance Load)
Relay Hold Time : 0.5 sec.
Response Time : < 0.3 sec.
Operating Temperature : -20°C to $+55^\circ\text{C}$ (-4°F to $+131^\circ\text{F}$)
Weight : 200g (7.1oz)
Accessories : 1 Cable 3m (9'10")
2 Mounting Screws
1 Operation Manual
1 Mounting Template
1 Area Adjustment Tool

*The specifications herein are subject to change without prior notice due to improvements.

OUTER DIMENSIONS

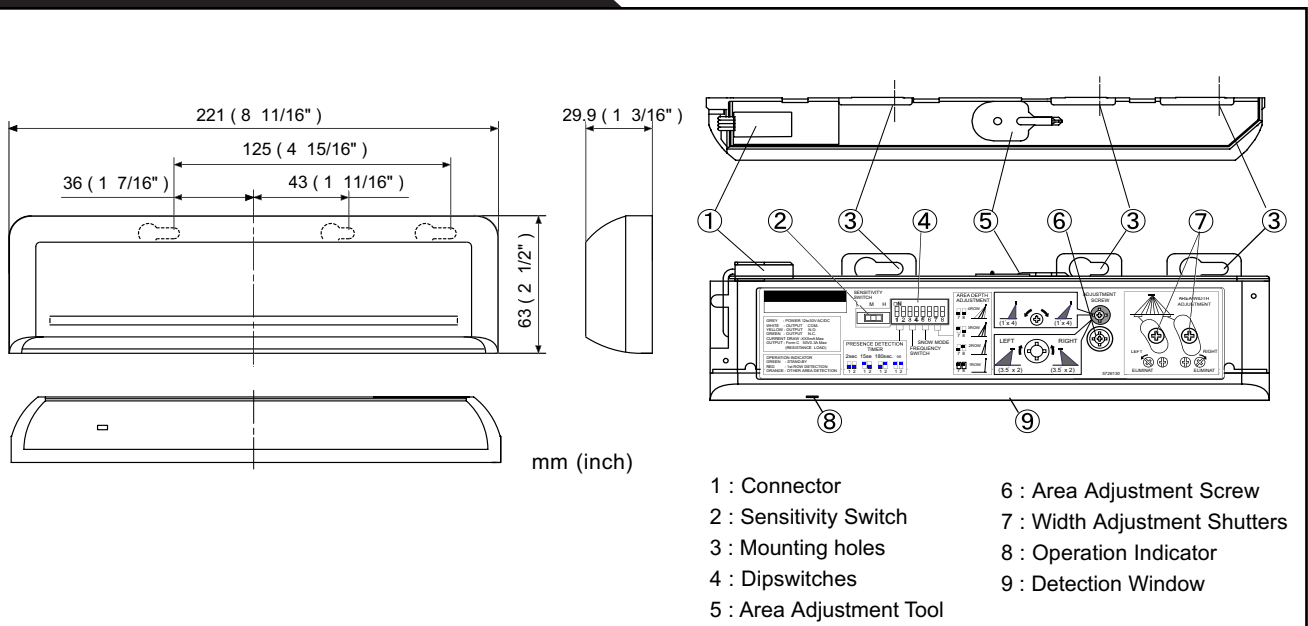

INSTALLATION

1

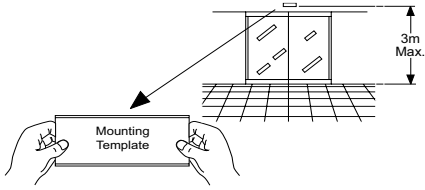

1. Affix the Mounting Template to the mounting surface.



2. Drill two mounting holes (\varnothing 3.4mm or 1/8").
3. To carry through the wire to the header, drill a wiring hole (\varnothing 8mm or 5/16").
4. After drilling the holes, remove the Mounting Template.

Note

Be sure that the mounting height is within the value of those in "SPECIFICATION."

2

The cable is arranged to connect to the door controller properly as shown below.



Note

Connect the cable when main power is turned off.

Note

When passing through the cable to the hole, make sure not to tear shield: otherwise it may cause electric shock or breakdown of sensor.

3

Remove the cover and attach the sensor with screws.

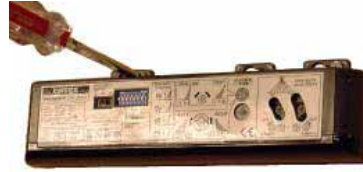

4

Plug the Connector for the sensor to that for the cable.



5

Supply power to the sensor. Adjust the detection area and set the various Switches. (See "ADJUSTMENT.")

Note

Make sure that you connect the cable correctly to the Control Unit of the door before turning the power on.

6

1. Put back the cover on the sensor.
2. If wiring is to be exposed, break the Knockout.



DETECTION AREA

Detection Areas are shown in the figure below.

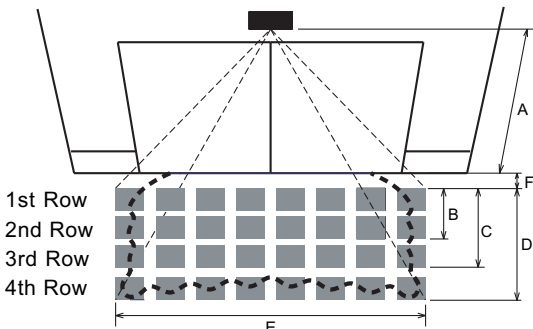

■ : Emitting Spot
 □ : Detection Area

Provided Detection Row type	1st	2nd	3rd	4th
Presence Detection	○	○	×	×
Motion Detection	○	○	○	○

After adjustment, turn the power off and on again, be sure to walk-test all of detection areas.

*The values of the chart below is of the Emitting Spots, but not of the Detection Area.

The actual Detection Area may become smaller depending on the ambience light and the colour / material of object and the floor as well as the entry speed of object.

	[m]				
A	2.00	2.20	2.50	2.70	3.00
B	0.28	0.31	0.35	0.38	0.41
C	0.68	0.75	0.85	0.92	1.02
D	1.18	1.30	1.48	1.59	1.77
E	2.10	2.30	2.60	2.80	3.10
F	0.16	0.18	0.20	0.22	0.25

	[feet , inch]				
A	6' 6 3/4"	7' 2 5/8"	8' 2 7/16"	8' 10 5/16"	9' 10 1/8"
B	11"	1' 3/16"	1' 1 3/4"	1' 2 15/16"	1' 4 9/16"
C	2' 2 3/4"	2' 5 1/2"	2' 9 9/16"	3' 1/4"	3' 4 3/16"
D	3' 10 7/16"	4' 3 3/16"	4' 10 1/4"	5' 2 5/8"	5' 9 11/16"
E	6' 10 11/16"	7' 6 9/16"	8' 6 3/8"	9' 2 1/4"	10' 2 1/16"
F	6 5/16"	7 1/16"	7 7/8"	8 11/16"	9 13/16"

ADJUSTMENT

1

Adjusting the Pattern Width

Setting the Width adjustment shutters

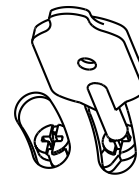
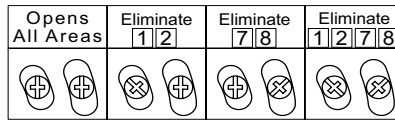

Adjusting the Width Angle
Left or Right : between 0° to 7°
(3.5° per click)

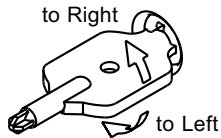

Pattern when Standard

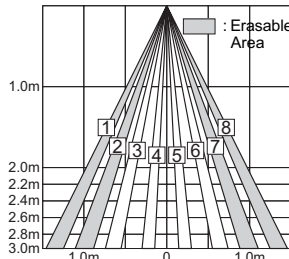

Pattern when changed 7° to Left

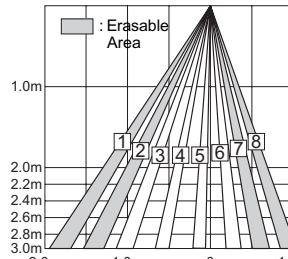

Pattern when changed 7° to Right

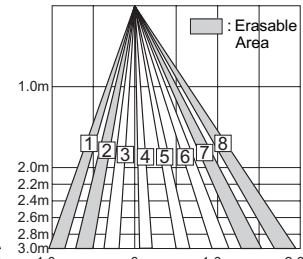

Note Setting the pattern for exact door opening may give a slow response to side approaching traffic.

2

Adjusting the Pattern Depth

Setting the Row with the Dipswitch 7 & 8.



Adjusting the Depth Angle between -4° to 4°
(1° per click).

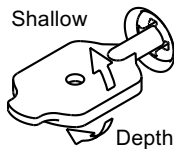

Pattern when Standard

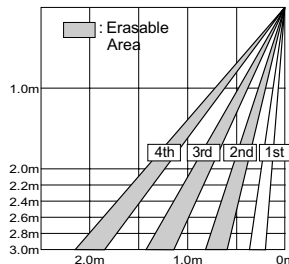

Pattern when changed -4° to Shallow (inside).

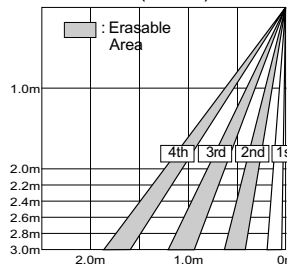

Pattern when changed 4° to Deep (outside).

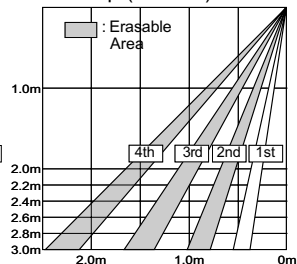

Note Set the pattern for actual traffic. It may cause slow activation for the traffic from the front, when the Row is eliminated.

3

Setting of Sensitivity Switch and Dipswitches

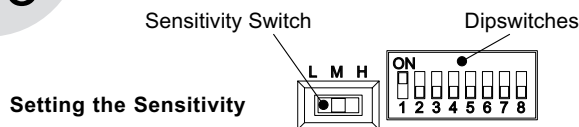

Setting the Sensitivity

Normally set to "M."
"H" increases the sensitivity and "L" lowers the sensitivity.

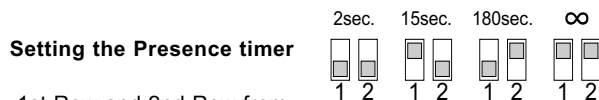

Setting the Presence timer

- 1st Row and 2nd Row from door provide the presence detection.
- Select the presence detection time.
 - Turn the power off and on again. Otherwise it may leave door open for the duration of the presence time set.
 - After making sure that the door closes, wait for 10 seconds before entering the detection area to set the Presence timer.

Setting the Frequency Function (Interference Prevention)

Four different frequencies can be set by adjusting the Dipswitch 3 and 4.

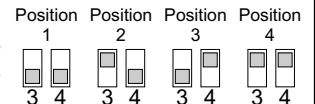

Note When two or more sensors are installed close to each other, it is possible that they interfere. When that happens, change the Frequency.

Setting the Snow mode

Set the Dipswitch5 and 6 to snow mode, if the sensor is used in a region with snow or a lot of insects.

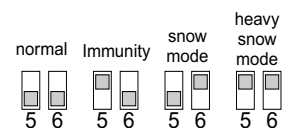

CHECKING

Check the operation according to the chart below.

Entry motion (image)	Power OFF 	Outside the Detection area 	Entry into 3rd or 4th Row 	Entry into 2nd Row 	Entry into 1st Row 	Outside the Detection area
Sensor status	Power OFF	Stand-by	Motion Detection Active	Motion or Presence Detection Active		Stand-by
Operation indicator	OFF	Green	Orange		Red	Green
Output						

Note The door may open once after the power is switched on.

Inform the following items to the building owner/operator

1. When turning the power on, always walk-test the sensor pattern to ensure proper operation.
2. Always keep the detection window clean. If dirty, wipe the window with a damp cloth. (Do not use any cleaner or solvent.)
3. Do not wash the sensor with water.
4. Do not disassemble, rebuild or repair the sensor yourself; otherwise electric shock may occur.
5. Contact your installer or the sales engineer if you want to change the settings.
6. Do not place an object that moves or emits light in the detection area. (Ex. Plant, illumination, etc.)
7. Do not paint the Detection Window.

TROUBLESHOOTING

TROUBLE	POSSIBLE CAUSE	SOLUTION
NE DOES NOT OPERATE	Power supply is not adequate.	Adjust to stated voltage.
	Connection Failure.	Check the wiring and the connector.
DOSE NOT OPERATE CONSISTENTLY	Dirty detection window.	Wipe the detection window with a damp cloth. (Do not use any cleaner or solvent.)
	Sensitivity is Low.	Set the Sensitivity Switch "H."
OPERATES BY ITSELF (GHOSTING)	There is an object that moves or emits light in the detection area. (Ex. plant, illumination, etc.)	Remove the object.
	Vibration of the header.	Secure the header. Or set the Sensitivity Switch "L."
	Sensitivity is high.	Set the Sensitivity Switch "L."
	Waterdrops on detection window.	Install in a place keeping the waterdrops off. OR use a rain-cover (Optional).
	Detection area has interfered the area of another sensor.	Set the different frequency position each other.
	The detection 1st row spots are overlapping with the door / header.	Adjust the detection area to deep (outside).
	There is an reflected object in the detection area. Solar light reflects.	Remove the object.
	There was a puddle left by rain or snow. The floor has gotten wet. The exhaust of the car and the fog penetrate into the detection area.	This sensor is equipped with the anti-malfunction. However, pay attention when installing as malfunction may occur under the left conditions.
DOOR STAY OPEN OR CLOSED	Presence timer is Infinity. There was an abrupt condition change in the detection area.	Turn the power off and on again.

*Contact your installer or the sales engineer if:
- the trouble still persists after checking and remedying as described above.*

DECLARATION CE OF CONFORMITY

Pursuant to the Electromagnetic compatibility Directive

CAME CANCELLI AUTOMATICI S.p.A.
Via Martiri della Libertà, 15
31030 Dosson di Casier
TREVISO - ITALY

Is fully liable in declaring that the products listed below:

ACTIVE INFRARED PRESENCE SENSORS

MR8003

comply with the National Law related to the following European Directives and to the applicable parts of the following Standards:

89/336/EEC - 92/31/EEC

Electromagnetic compatibility Directive

89/106/EEC

Construction products Directive

EN 61000-6-2
EN 61000-6-3
EN 13241-1

Dosson di Casier, 29th November 2005

The Managing Director
Andrea Menuzzo

Reference code to request a true copy of the original

DDF E GB
R001 Ver 1.1



ASSISTENZA TECNICA
NUMERO VERDE
800 295830
WEB
www.came.it
E-MAIL
info@came.it



CAME NORD S.R.L. COLOGNO MONZESE (MI)
☎ (+39) 02 26708293 ☎ (+39) 02 25490288
CAME SUD S.R.L. NAPOLI
☎ (+39) 081 7524455 ☎ (+39) 081 7529109
CAME (AMERICA) L.L.C. MIAMI (FL)
☎ (+1) 305 5938798 ☎ (+1) 305 5939823
CAME AUTOMATISMOS S.A. MADRID
☎ (+34) 091 5285009 ☎ (+34) 091 4685442
CAME BELGIUM LESSINES
☎ (+32) 068 333014 ☎ (+32) 068 338019

CAME FRANCE S.A. NANTERRE CEDEX (PARIS)
☎ (+33) 01 46130505 ☎ (+33) 01 46130500
CAME GMBH KORNTAL BEI (STUTT GART)
☎ (+49) 07 15037830 ☎ (+49) 07 150378383
CAME GMBH SEEFELD BEI (BERLIN)
☎ (+49) 03 33988390 ☎ (+49) 03 339885508
CAME PL SP.ZO.O WARSZAWA
☎ (+48) 022 8365076 ☎ (+48) 022 8369920
CAME UNITED KINGDOM LTD NOTTINGHAM
☎ (+44) 0115 9210430 ☎ (+44) 0115 9210431

CAME CANCELLI AUTOMATICI S.P.A.
DOSSON DI CASIER (TREVISO)
☎ (+39) 0422 4940 ☎ (+39) 0422 4941